



UNICAIR[®]
Pneumatic Tools

UNICAIR[®]

**CLAVADORAS
NAILERS
CLOUEUSES**

- | | |
|---------------------|---------------------|
| 07 NOVA 6/30 | 21 NOVA 97/25 |
| 07 NOVA 6/45 | 21 NOVA 90/30 |
| 07 C-8/30Pins N | 21 NOVA 92/30 |
| 07 NOVA 8/45 | 21 NOVA 90/40 |
| 08 NOVA 12/40 | 21 NOVA 92/40 |
| 08 NOVA 12/60 | 22 NOVA 14B/50 |
| 08 C-14/64 NT | 22 NOVA 16NC/50 |
| 09 C-1/30 N | 22 NOVA 16NC/64 |
| 09 NOVA 12-90/32 | 22 G-SK/38 |
| 09 C-CG 12-90/40 | 23 NOVA CF/15 |
| 10 NOVA TN/64 | 23 G-SCF/16 N |
| 10 NOVA TN/75 | 24 G-CM 19/35 M |
| 11 NOVA 1,2/40 AC | 24 G-CN 19/35 N |
| 11 C-MINI TN/40 MIX | 24 G-CR 11/95 R |
| 11 NOVA 1,8/50 | 25 G-MA/15V |
| 12 C-3,0/64 CM | 25 G-15/10 V |
| 12 C-3,0/40 CM | 25 SOPORTE G-15/10V |
| 14 C-AF/50 ANG | 25 G-OMEGA/18 |
| 14 C-FAN/64N-DA | |
| 14 C-15/50 AB | |
| 15 C-RN/130 | |
| 15 C-RN/160 | |
| 15 C-RN/90N | |
| 15 C-34/100AF | |
| 16 C-CB/8100P | |
| 16 C-CB/8130P | |
| 16 C-CB/790P | |
| 17 C-CB/3145R | |
| 17 C-CB/555P | |
| 17 C-CB/670P | |

**COMPRESORES
COMPRESSORS
COMPRESSEURS**

















- | |
|-----------------|
| 26 CS-1,5/6L |
| 26 FENIX MC-100 |
| 26 CP-1510 |
| 26 CD-1,5/6L |
| 27 CD-2/24L |
| 27 CD-2,5/50L |
| 27 CD-3/50L |
| 27 CC-3/50L |
| 27 CC-3/100L |

**HERRAMIENTAS VARIAS
VARIOUS TOOLS
OUTILLAGE DIVERS**

- | |
|--|
| 28 TN-705 |
| 28 TN-705PA |
| 28 AN-803 |
| 28 AN-833 |
| 28 ANR-141 |
| 28 ANR-161 |
| 29 LL-241 KIT |
| 29 LL-245 IND |
| 29 LL-261 |
| 29 LL-233 KIT |
| 30 LB-372 |
| 30 RN-902 |
| 30 LRO-317 N |
| 30 LRO-318AS N |
| 30 AR-111 |
| 31 EN-1006 |
| 31 AS-1002 |
| 31 MB-A09 |
| 32 RM-20 |
| 32 EP-15 |
| 32 EP-812 ER |
| 32 EP-1208/8 |
| 32 EP-1208/15 |
| 32 R812/50 |
| 33 FRL-400 |
| 33 FRL-300 |
| 33 FRL-200 |
| 33 FR-200 |
| 33 ENCHUFES y RACORDS
CONNECTIONS RACCORDS
CONNEXIONS RACCORDS |

**GRAPADORAS
STAPLERS
AGRAFEUSES**

- | |
|--------------------|
| 18 NOVA 80/16 |
| 18 G-80/16CL |
| 18 G-80/16 CL AUT. |
| 19 G-80/16 ML N |
| 19 G-80/25 N2 |
| 19 NOVA 71/16 |
| 20 G-CH/16 |
| 20 G-SJK/16 |
| 20 G-84/16 |

- | | |
|--|---|
| Puntas sin cabeza
Headless Pin
Aguilles Sans Tête |  |
| Puntas con cabeza
Head Pin
Aguilles á Tête |  |
| Clavos en peine
Framing nails
Clous en peigne |  |
| Clavos "DA"
"DA" nails
Clous "DA" |  |
| Grapas
Staples
Agrafes |  |
| Clavos en rollo
Coil nails
Clous en rouleau |  |
| Presión trabajo
Operating pressure
Pression de travail |  |
| Peso Neto
Net Weight
Poids net |  |
| Medidas
Dimensions
Dimensions |  |
| Racord Flexible
Flexible Plug
Raccord Flexible |  |
| Consumo por impacto
Air consumption per shot
Consommation par coup |  |
| Cargador
Magazine capacity
Chargeur |  |
| Potencia
Power
Puissance |  |
| Calderín
Tank
Cuve |  |
| Caudal
Air flow
Débit |  |
| Nivel sonoro
Noise level
Niveau sonore |  |



NOVA 6/30

Fijación de molduras y marcos, tapa juntas, decoración en muebles. **Fastening of mouldings and frames, for wood and plastic.** Fixation de moulures et encadrements en bois, décoration de meubles, pose de baguettes.



NOVA 6/30



C-8/30Pins N

Fijación de molduras y marcos, tapa juntas, decoración en muebles, etc. **Fastening of mouldings and pictures frame assembly, furniture, etc.** Fixation de moulures et encadrements en bois, décoration de meubles, pose de baguettes, etc.



C-8/30Pins N



NOVA 6/45

Fijación de molduras y marcos, tanto en madera como en PVC. **Fastening of mouldings and frames, for wood and plastic.** Fixation de moulures et encadrements en bois ou PVC.



NOVA 6-45



NOVA 8/45

Fijación de molduras y marcos, tapa juntas, decoración en muebles, etc. **Fastening of mouldings and picture frames assembly, furniture etc.** Fixation de moulures et encadrements en bois, décoration de meubles, pose de baguettes, etc.

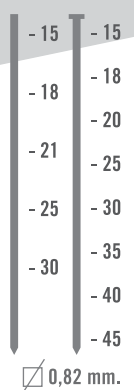







NOVA 8-45

	NOVA 6/30	NOVA 6/45	NOVA 8/45	C-8/30Pins
IT	0,64 mm.	0,64 mm.	0,82 mm.	0,82 mm.
	4/5 bar	4/6 bar	4/6 bar	4/6 bar
	1 Kg.	1,1 Kg.	1,1 Kg.	1,4 Kg.
	230x180 mm.	225x227 mm.	225x227 mm.	255x180 mm.
	¼" ∅ 5 mm.	¼" ∅ 5 mm.	¼" ∅ 5 mm.	¼" ∅ 5 mm.
	0,35 L.	0,45 L.	0,45 L.	0,35 L.

NOVA 12/40

NOVA 12/40

 1,2 mm.	 230x210 mm.
 5/7 bar	 ¼" Ø 5 mm.
 1,3 Kg.	 0,55 L.







Fijación de tapa juntas, molduras rústicas, fabricación de muebles, decoración, etc. **Fastening of rustic mouldings, furniture, decoration, etc.**
 Fixation de couvres joints, moulures rustiques, fabrication de meubles, décoration, assemblage de tiroirs, etc.



1,2 x 1 mm.

NOVA 12/60

NOVA 12/60

 1,2 mm.	 230x245 mm.
 5/7 bar	 ¼" Ø 5 mm.
 1,4 Kg.	 0,70 L.







Fijación de tapa juntas, molduras rústicas, fabricación de muebles, decoración, etc. **Fastening of rustic mouldings, furniture, decoration, etc.**
 Fixation de couvres joints, moulures rustiques, fabrication de meubles, décoration, assemblage de tiroirs, etc.



1,2 x 1 mm.

C-14/64 NT

C-14/64 NT

 1,4 mm.	 320x300 mm.
 5/7 bar	 ¼" Ø 8 mm.
 2,4 Kg.	 1,10 L.







Muebles, sillas, ensablado de madera, ventanas, esqueletajes, etc. **Furniture, chairs, wood assembly, windows, etc.**
 Meubles, chaises, assemblage en bois, fenêtres, menuiserie industrielle, etc.



1,4 x 1,6 mm.

C-I/30 N

C-I/30 N





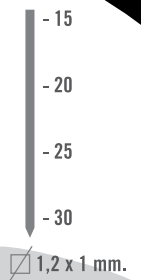

 1,2 mm.	 250x200 mm.
 5/6 bar	 ¼" Ø 5 mm.
 1,2 Kg.	 0,45 L.

Fabricación de muebles, unión de paneles, decoración y ensamblado de madera. **Furniture, panel joints, decoration and boards assembly.**
Fabrication de meubles, assemblage de panneaux, décoration et assemblage de tiroirs.



NOVA 12-90/32

NOVA 12-90/32







 90  1,2 mm.	 235x210 mm.
 5/7 bar	 ¼" Ø 5 mm.
 1,2 Kg.	 0,55 L.

Fijación de tapa juntas, molduras, carpintería, y mueble en general. **Fastening of mouldings, picture frames assembly, joinery and general furniture.**
Fixation de couvre-joints, moulures, menuiserie, et meubles en général.



C-CG 12-90/40

C-CG 12-90/40

 90  1,2 mm.	 260x250 mm.
 5/7 bar	 ¼" Ø 5 mm.
 1,6 Kg.	 0,65 L.

Fijación de tapa juntas, molduras, carpintería, y mueble en general. **Fastening of mouldings, picture frames assembly, joinery and general furniture.**
Fixation de couvre-joints, moulures, menuiserie, et meuble en général.



CLAVOS ACERO
 FIJACIÓN PARA LA CONSTRUCCIÓN
STEEL NAILS
 CONSTRUCTION FASTEN
CLOUS ACIER
 FIXATION POUR CONSTRUCTIONS ET BATIMENTS



NOVA TN/64-75

NOVA TN 64-75

	NOVA TN/64	NOVA TN/75
T	2,2 mm.	2,2 mm.
	6/7 bar	6/7 bar
	2,7 Kg.	2,7 Kg.
	320x320 mm.	330x320 mm.
	¼" Ø 8 mm.	¼" Ø 8 mm.
	1,35 L.	1,35 L.







Fijación de tarima, parquet, rastreles, enconfrados y carpintería pesada. **Wooden floor, plank works and heavy carpentry.** Fixation de lambris, plancher, lambourdes, coffrages et menuiserie lourde.

Morro especial tarimas
 Special flooring nose
 Bec spécial parquet



NOVA 1,2/40AC

NOVA 1,2/40AC







 1,2 mm.	 230x210 mm.
 5/7 bar	 ¼" Ø 5 mm.
 1,3 Kg.	 0,50 L.

Fijación de rodapié, tarimas, revestido de paredes, molduras, etc. **Skirting boards, latticework for panels, fastening of mouldings, frames assembly, etc.** Fabrication de meubles, assemblage de panneaux, décoration, assemblage de tiroirs, etc.



C-MINI TN/40 MIX

C-MINI TN/40 MIX







 1,8	 1,4 mm.	 280x260 mm.
 5/7 bar	 ¼" Ø 8 mm.	
 1,5 Kg.	 0,60 L.	

Fijación de rodapié, tarimas, revestido de paredes, molduras, etc. **Skirting boards, latticework for panels, fastening of mouldings, frames assembly, etc.** Fixation de lambris, revêtements de murs, meubles, moulures, etc.



NOVA 1,8/50

NOVA 1,8/50

 1,8 mm.	 310x280 mm.
 5/8 bar	 ¼" Ø 8 mm.
 2,1 Kg.	 1,10 L.

Fijación de rodapié, tarimas, revestido de paredes, techos de pizarra, etc. **Skirting boards, latticework for panels, fastening of mouldings, frames assembly, etc.** Fabrication de meubles, assemblage de panneaux, décoration, assemblage de tiroirs, etc.



UNICAIR

C-3,0/40-64 CM

Ahorra hasta un 50% por disparo en comparación con clavadoras de gas. **Save until 50% per shoot comparing with the gas nailers. 50% plus économique que les cloueuses à gaz.**

No es necesario utilizar costosos compresores de alta presión, trabaja con compresores convencionales entre 5.5 y 8 Bares. **Is not necessary to use expensive high pressure compressors, it works with conventional compressors between 5.5 and 8 bars. Les compresseurs à haute pression ne sont pas nécessaires, ces cloueuses travaillent avec des compresseurs conventionnels à une pression entre 5,5 et 8 bars.**

2 veces más rápida que los sistemas de clavado de gas, 5 veces más rápida que las clavadoras de pólvora. **2 times faster than gas nailer system and 5 times faster than powder nailers. 2 fois plus rapides que les cloueuses à gaz et 5 fois plus que les cloueuses à poudre.**

Mantenimiento sencillo, ahorre tiempo en complejos procedimientos de limpieza como en las clavadoras de gas. **Simple maintenance, save time in complicated cleaning procedures as the gas nailers. Entretien facile, temps de procédure de nettoyage plus réduit que sur les cloueuses à gaz.**

Carga trasera en dos pasos: Rápido y fácil para personas diestras y zurdas. **Back two steps loading: Fast and easy for right and left handers. Chargement arrière en deux pas: rapide et facile pour droitiers et gauchers.**

Perfectamente equilibrada y diseño ergonómico. **Perfectly balanced and ergonomically designed. Dessin ergonomique et parfaitement équilibré.**

Más ligera que las clavadoras de gas.

Lighter than gas nailer.

Plus légers que les cloueuses à gaz.

ELECCIÓN DEL TAMAÑO DEL CLAVO

Cuando se utiliza para clavar madera sobre hormigón, la intrusión del clavo en el hormigón tiene que ser un máximo de 20mm.

Longitud total del clavo = $H_m + T_{fix}$

NAILS SIZE CHOICE

When nailing wood to concrete, the nail intrusion to the concrete should be maximum 20mm.

Total length of the nail = $H_m + T_{fix}$

ÉLECTION DE LA TAILLE DU CLOU

Pour clouer bois sur du béton, le clou doit s'introduire 20mm maximum.

Longueur totale du clou = $H_m + T_{fix}$

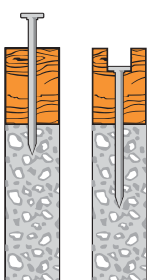
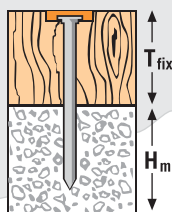

Cuando se utiliza para clavar madera sobre acero o hierro hay que tener en cuenta que el grosor del metal no debe superar el diámetro del clavo que se utilice.

When nailing wood to steel or iron, the metal thickness should not surpass the nails diameter.

Pour clouer bois sur du métal, l'épaisseur de celui ne doit pas dépasser le diamètre du clou.



APLICACIONES

- Fijación de rastrel
- Paredes de pladur
- Soportes para falsos techos
- Malla de metal
- Acero o hierro sobre hormigón
- Madera sobre hormigón
- Paneles de revestimiento
- Soportes de pared
- Viguetas de C a hormigón
- Soportes para suelo flotante







APLICATIONS

- Fastening of drywall track
- Ceiling grid
- Metal sheet roofing
- Steel or iron to concrete
- Wood to concrete
- Wall and roof sheathing
- Wall supports
- C-shaped to concrete
- Subflooring and under-layment
- Fixation des lattes de l'ossature pour plaques de plâtre
- Support de faux plafonds
- Maille métallique
- Acier o fer sur béton
- Bois sur béton
- Panneaux de recouvrement
- Support de murs
- Poutrelles en C sur béton
- Support pour parquets flottants

NOVA UNICAIR

C-3,0/64 CM





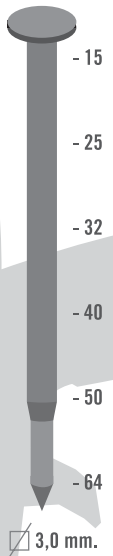
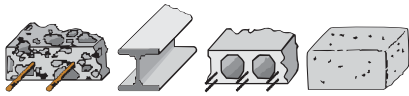

C-3,0/64 CM

 3,0 mm.	 440x440 mm.
 6/8 bar	 1/4" Ø 8 mm.
 5,2 Kg.	 2,00 L.



C-3,0/40 CM

C-3,0/40 CM

 3,0 mm.	 410x350 mm.
 6/8 bar	 1/4" Ø 8 mm.
 3,5 Kg.	 1,70 L.

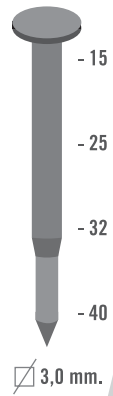
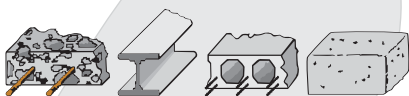

C-AF/50 ANG

C-AF/50 ANG

1,2 mm. 26°	320x260 mm.
5/7 bar	1/4" Ø 5 mm.
1,5 Kg.	0,60 L.

Fijación de tapa juntas, cornisas, molduras rústicas, trabajos de carpintería con difícil acceso, etc. **Fastening of mouldings, cornices, difficult acces works, etc.** Fixation, corniches, moulures rustiques, travaux de menuiserie d'accé difficile, etc.

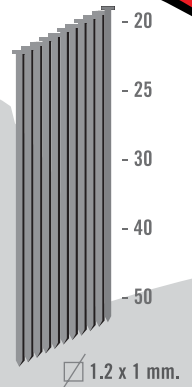

C-FAN/64N-DA

C-FAN/64N-DA

1,83mm. 34°	340x310 mm.
6/7 bar	1/4" Ø 8 mm.
2,5 Kg.	1,30 L.

Fijación de tarima, parquet, casa de madera, carpintería pesada, puertas, ventanas, etc. **Wooden floor, plank works and heavy carpentry, doors, windows, etc.** Fixation de plancher, parquet, maisons en bois, menuiserie lourde, escaliers, portes, fenêtres, etc.

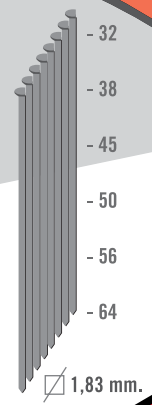

C-15/50AB

C-15/50AB

1,83mm. 26°	320x260 mm.
5/7 bar	1/4" Ø 8 mm.
1,5 Kg.	0,90 L.

Fijación de tarima, parquet, casa de madera, carpintería pesada, puertas, ventanas, etc. **Wooden floor, plank works and heavy carpentry, doors, windows, etc.** Travaux de finition, cloisonnages, aménagements intérieur, maisons en bois, portes, fenêtres, etc.

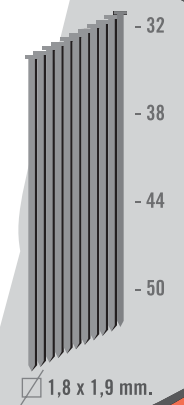

NOVA

C-RN/130-160

	C-RN/130	C-RN/160
21°	3,05-4,1	3,8-5 mm.
6/8 bar	6/8 bar	6/8 bar
5,8 Kg.	5,8 Kg.	7,1 Kg.
530x450 mm.	530x450 mm.	530x475 mm.
¼" Ø 8 mm.	¼" Ø 8 mm.	¼" Ø 8 mm.
2,35 L.	2,35 L.	2,5 L.
66	66	50

Construcción de carpintería pesada, embalajes pesados y encofrados. **Wooden structures, plank works, frames, heavy carpentry and packaging. Menuiserie lourde, coffrages, palettes, emballages lourds, caisses, liteaux and bardages.**

LISO - HELICOIDAL
SMOOTH - SCREW
LISSE - HÉLICOIDAL

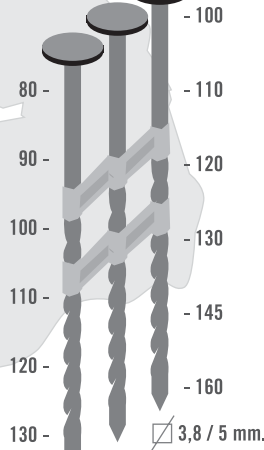

∅ 3,05 / 4,1 mm.



C-RN/90N

2,87-4,1 mm.	500x370 mm.
21°	
6/8 bar	¼" Ø 8 mm.
3,6 Kg.	2 L.
66 clavos nails clous	

Construcción de carpintería pesada, embalajes pesados y encofrados. **Wooden structures, plank works, frames, heavy carpentry and packaging. Menuiserie lourde, coffrages, palettes, emballages lourds, caisses, liteaux et bardages.**

LISO - HELICOIDAL
SMOOTH - SCREW
LISSE - HÉLICOIDAL

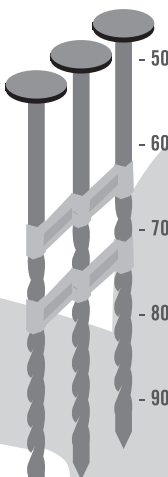

∅ 2,87 / 4,1 mm.



C-34/100AF

2,87-3,8 mm.	510x370 mm.
34°	
6/8 bar	¼" Ø 8 mm.
3,4 Kg.	2,10 L.
90 clavos nails clous	

Construcción de carpintería pesada, embalajes pesados y encofrados. **Wooden structures, plank works, frames, heavy carpentry and packaging. Menuiserie lourde, coffrages, palettes, emballages lourds, caisses, liteaux et bardages.**

LISO - ROSCAD
SMOOTH - RING
LISSE - ANNELLE

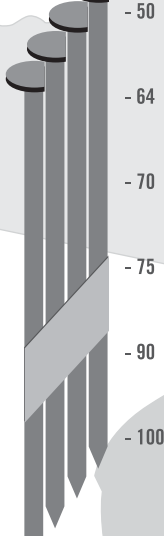

∅ 2,87 / 3,8 mm.





C-CB/8100P
C-CB/8130P

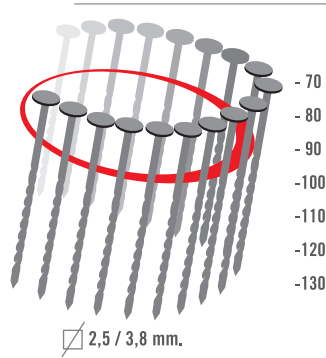

∅ 2,5 / 3,8 mm.

C-CB/8100P
C-CB/8130P



C-CB/790P

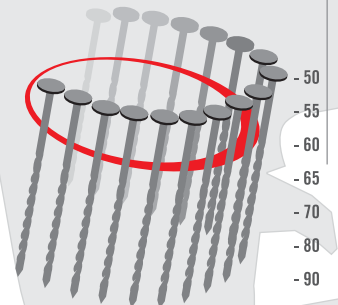

∅ 2,5 / 3,3 mm.

C-CB/790P

	C-CB/790P	C-CB/8100P	C-CB/8130P
	2,5/3,3mm	2,5/3,8mm	2,5/3,8mm
	15-16°	15-16°	15-16°
	6/8 bar	6/8 bar	6/8 bar
	3,8 Kg.	4,2 Kg.	4,8 Kg.
	370x300 mm.	390x320 mm.	420x320 mm.
	¼" ∅ 8 mm.	¼" ∅ 8 mm.	¼" ∅ 8 mm.
	2,1 L.	2,2 L.	2,5 L.
	300	300	300

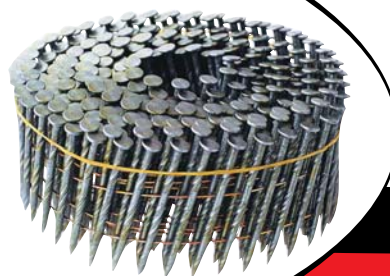



C-CB/3145R

CLAVADORA ROOFING
ROOFING NAILER
CLOUSEUSE ROOFING



∅ 3,05 mm.

C-CB/3145R
-19
-22
-25
-28
-32
-38
-45

C-CB/670P

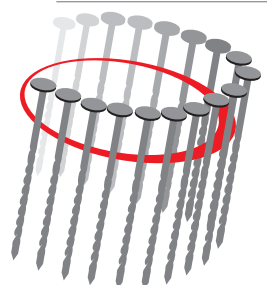

∅ 2,3 / 3,1 mm.

C-CB/670P
-40
-45
-50
-55
-60
-65
-70

C-CB/555P

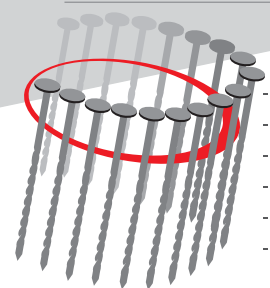

∅ 2,1 / 2,5 mm.







C-CB/555P
-25
-32
-40
-45
-50
-55



	C-CB/3145R	C-CB/555P	C-CB/670P
	3,05 mm	2,1/2,5mm	2,3/3,1mm
	15-16°	15-16°	15-16°
	5/7 bar	6/8 bar	6/8 bar
	2,5 Kg.	2,5 Kg.	2,9 Kg.
	270x280 mm.	270x300 mm.	330x300 mm.
	¼" ∅ 8 mm.	¼" ∅ 8 mm.	¼" ∅ 8 mm.
	1,3 L.	1,5 L.	1,8 L.
	120	300	300

NOVA 80/16

NOVA 80/16





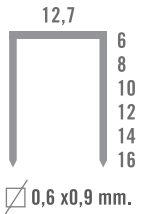

 80	 205x145 mm.
 5/7 bar	 1/4" Ø 5mm.
 0,9 Kg.	 0,30 L.

Tapicerías, muebles, decoración, etc...
Upholstery, furniture, decoration, etc...
Tapisserie, meubles, décoration, fermetures de caissettes, etc...



G-80/16 CL

G-80/16 CL





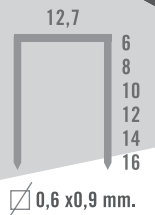

 80	 380x145 mm.
 5/7 bar	 1/4" Ø 5mm.
 0,9 Kg.	 0,30 L.
 200 grapas staples agrafes	

Tapicerías, muebles, decoración, etc...
Upholstery, furniture, decoration, etc...
Tapisserie, meubles, décoration, fermetures de caissettes, etc...



G-80/16 CL AUT

G-80/16 CL AUT

 80	 380x145 mm.
 5/7 bar	 1/4" Ø 5mm.
 0,95 Kg.	 0,40 L.
 200 grapas staples agrafes	

Tapicerías, muebles, decoración, etc...
Upholstery, furniture, decoration, etc...
Tapisserie, meubles, décoration, fermetures de caissettes, etc...

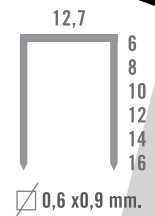

UNICAIR NOVA

G-80/16 ML N

80	300x155 mm.
5/7 bar	¼" Ø 5mm.
1,2 Kg.	0,40 L.
Morro largo Nose length Bec long 50mm.	

Tapicerías, muebles, decoración, embalajes ligeros de madera, etc... **Upholstery, furniture, decoration, light wooden boxes, etc...** Tapisserie, meubles décoration, emballages légers en bois, etc...

G-80/16 ML N

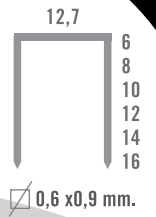

G-80/25 N2

80	260x174 mm.
5/7 bar	¼" Ø 5mm.
1,2 Kg.	0,40 L.

Tapicería, muebles, decoración, embalajes ligeros de madera, etc... **Upholstery, furniture, decoration, light wood packing, etc...** Tapisserie, meubles décoration, emballages légers en bois, etc.

G-80/25 N2



NOVA 71/16

71 (S3G)	205x145 mm.
5/7 bar	¼" Ø 5mm.
1 Kg.	0,30 L.

Tapicería, muebles, decoración, embalajes ligeros de madera, etc... **Upholstery, furniture, decoration, light wood packing, etc...** Tapisserie, meubles décoration, emballages légers en bois, etc.

NOVA 71/16

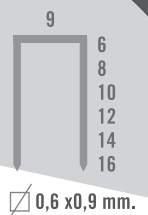







NOVA

NOVA

G-CH/16

G-CH/16





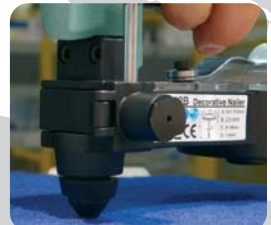
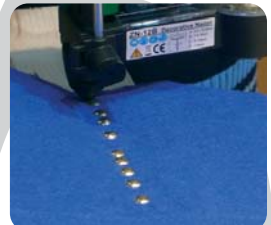
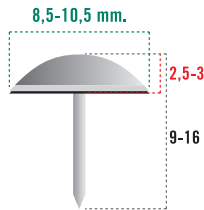

	CLAVOS DECORATIVOS DE TAPICERÍA DECORATIVE NAILS OF UPHOLSTERY CLOUS DÉCORATIFS DE TAPISSERIE	
	5/7 bar	 ¼" Ø 5mm.
	0,9 Kg.	 0,30 L.
	100 clavos granel bulk nails clous en vrac	 380x145 mm.

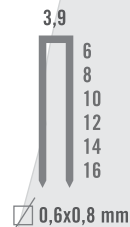
Tapicerías, muebles, decoración, etc...
Upholstery, furniture, decoration, etc...
Tapisserie, meubles, décoration, etc...



NOVA







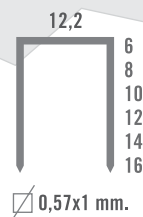

	SJK		200x140 mm.
	5/7 bar	 ¼" Ø 5mm.	
	0,9 Kg.		0,30 L.

Muebles, decoración, embalajes ligeros de madera
Furniture, decoration, light wood packing
Meubles, décoration, emballages légers en bois

G-84/16

G-84/16



	84		200x140 mm.
	5/7 bar	 ¼" Ø 5mm.	
	0,9 Kg.		0,30 L.

Tapicería, muebles, decoración, embalajes ligeros de madera
Upholstery, furniture, decoration, light wood packing
Tapisserie, meubles décoration, emballages légers en bois

NOVA 97/25

NOVA 97/25



97-4000	235x210 mm.
5/7 bar	¼" Ø 5mm.
1 Kg.	0,55 L.

Muebles, calzado, embalajes ligeros de madera, etc...
Furniture, footwear, light wood packing, etc...
Meubles, chaussures, emballages légers en bois, etc...



Ø 0,65 x 0,9 mm.

NOVA 90-92/30

NOVA 90-92/30



90-92	235x210 mm.
5/7 bar	¼" Ø 5mm.
1,2 Kg.	0,55 L.

Muebles, carpintería, sillería, esqueletajes, etc...
Furniture, carpentry, chairs, etc...
Meubles, menuiseries, chaises, squelletages, etc...

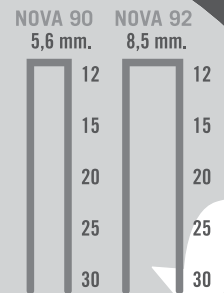

Ø 1 x 1,2 mm.

NOVA 90-92/40

NOVA 90-92/40



90-92	310x275 mm.
5/7 bar	¼" Ø 8mm.
2,1 Kg.	0,90 L.

Muebles, cajas, embalajes, sillería, esqueletajes, etc...
Furniture, carpentry, chairs, etc...
Meubles, menuiseries, chaises, squelletages, etc...



Ø 1 x 1,2 mm.

NOVA 14B/50

NOVA 14B/50

14B-55	390x310 mm.
5/8 bar	1/4" Ø 8 mm.
2,9 Kg.	1,30 L.

Armazones, tarimas, muebles, sillería, esqueletajes,...
Frameworks, wooden floor, furniture, chairs,...
 Meubles, menuiseries, chaises, esqueletages,...

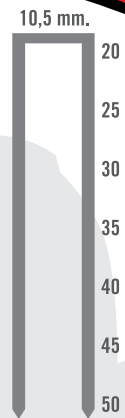

- 1,4 x 1,6 mm.
- 1,3 x 1,5 mm.

NOVA 16NC/50-64

NOVA 16NC/50-64

16-18 NC	390x310 mm.
6/8 bar	1/4" Ø 8mm.
2,7 Kg.	1,50 L.

Tarima, parquet, casas de madera, encofrados, armazones, ...
Frameworks, wooden floor, furniture, chairs,...
 Portes, parquet, maison en bois, cofrages, palettes, armatures industrielles du batiment,...



- 1,4 x 1,6 mm.
- 1,6 x 1,9 mm.



G-SK/38

G-SK/38

SK	355x290 mm.
6/8 bar	1/4" Ø 8mm.
2,6 Kg.	1,1 L.

Ensambles, premarcos, fijación cartón-madera, fijación moqueta, ...
Assembly, frames, cartonwood joining, insulation,...
 Assemblage de pièces, encadrements, agrafage carton-palette, fixation moquette, ...



26,4

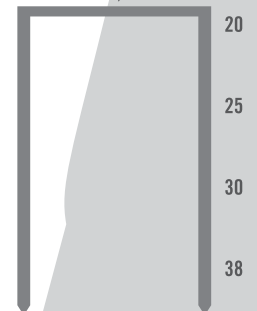







- 1,4 x 1,6 mm.

UNICAIR NOVA

NOVA CF15

NOVA CF15





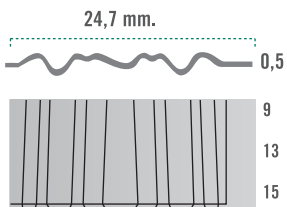

 "CF" 24,7mm.	 280x270 mm.
 6/8 bar	 ¼" Ø 8 mm.
 2,8 Kg.	 1,50 L.

Marcos, premarcos, ensambles,...
Assembly, frames, carton wood joining, insulation,...
 Cadres, encadrements, assemblage de pièces,...



G-SCF/16 N

G-SCF/16 N

 "SCF" 11,8mm.	 260x290 mm.
 6/8 bar	 ¼" Ø 8 mm.
 2 Kg.	 1,10 L.

Marcos, premarcos, ensambles,...
Assembly, frames, insulation,...
 Cadres, encadrements, assemblage de pièces,...

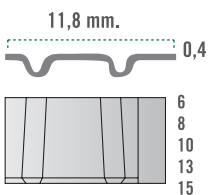

G-CM 19/35 M

G-CM 19/35M





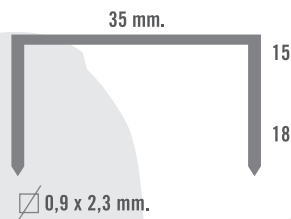

 35	 2,9 Kg.	 400x250 mm.
---	---	---

Montaje cajas de cartón, embalajes...
Packing, carton box assembly, ...
Montage boîtes et caisses en carton, emballages...



G-CN 19/35 N

G-CN 19/35 N





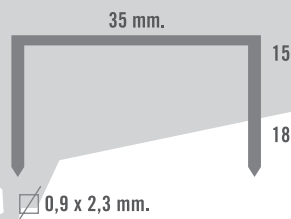

 35	 350x230 mm.
 5/6 bar	 1/4" Ø 5mm.
 2,8 Kg.	 0,90 L.

Montaje cajas de cartón, embalajes...
Packing, carton box assembly, ...
Montage boîtes et caisses en carton, emballages...



G-CR 11/95 R

G-CR 11/95 R

 35	ROLLO ROULEAU ROLL	 255x225 mm.
 5/6 bar	 1/4" Ø 5mm.	
 2,6 Kg.	 0,90 L.	



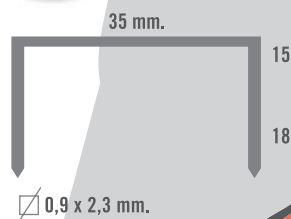



Montaje cajas de cartón, embalajes...
Packing, carton box assembly, ...
Montage boîtes et caisses en carton, emballages...



UNICAIR NOVA

G-MA/15V

G-MA/15V

 "V"	 550x300x360 mm.
 5/8 bar	 1/4" Ø 8 mm.
 30 Kg.	 2 L.

Ensamblado automático de marcos, cuadros,...
Automatic frame assembly, picture frames,...
Assemblage de cadres, encadrement,...

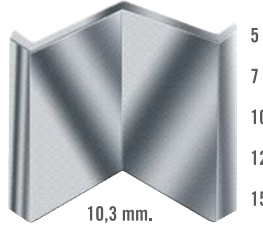
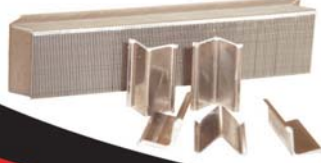







5
7
10
12
15

PRENSOR NEUMÁTICO HORIZONTAL Y VERTICAL.
PNEUMATIC PISTON HOLDER VERTICAL AND HORIZONTAL
PNEUMATIQUE PISTON HORIZONTAL ET VERTICAL



G-15/10 V

G-15/10 V

 "V"	 240x195 mm.
 5/7 bar	 1/4" Ø 5 mm.
 1,2 Kg.	 0,80 L.

Ensamblado de marcos, cuadros,...
Frame assembly, picture frames,...
Assemblage de cadres, encadrement,...

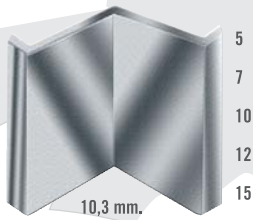

5
7
10
12
15





Soporte grapadora opcional
Optional stapler holder
Optionel support agrafeuse



G-OMEGA/18

G-OMEGA/18

 18 OMEGA
 170x140 mm.
 0,3 Kg.

Construcción y agricultura.
Construction and agriculture.
Construction et cloturage.



18 mm.

Ø 2,2 mm.

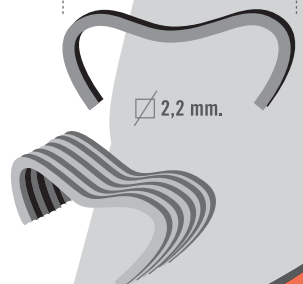

UNICAIR NOVA

compresores compressors compresseurs



CS-1,5/6L

SILENCIOSO
SILENT
SILENCIEUX

CS-1,5/6L



FENIX MC

SERIE 100



CD-1,5/6L

CD-1,5/6L



CP 1510

CP 1510

	CS-1,5/6L.	FENIX MC SERIE 100	CD-1,5/ 6L	CP 1510
	1,5 Hp.	1/4 Hp.	1,5 Hp.	1,5 Hp.
	6 L.	0,8 L.	6 L.	10 L.
	8 bar.	9 bar.	8 bar.	8 bar.
	152 L./min.	45 L./min.	124 L./min.	130 L./min.
	1.400	3.500	2.850	2.850
	550x220x500 mm.	225x287x130 mm.	495x240x475 mm.	440x230x520 mm.
	18 Kg.	4,8 Kg.	16 Kg.	10 Kg.
	45 Db.	70 Db	80 Db	85 Db
	sin aceite oil-less sans huile	sin aceite oil-less sans huile	lubricado oil lubrifié	sin aceite oil-less sans huile



CD-2/24L

CD-2/24L



CD-2,5/50L

CD-2,5/50L







CD-3/50L

CD-3/50L



CC-3/ 50L
CC-3/100L

CC-3/50L
CC-3/100L

	CD- 2/ 24L	CD- 2,5/ 50L	CD- 3/ 50L	CC- 3/ 50L	CC- 3/ 100L
	2 Hp.	2,5 Hp.	3 Hp.	3 Hp.	3 Hp.
	24 L.	50 L.	50 L.	50 L.	100 L.
	8 bar.	8 bar.	8 bar.	8 bar.	8 bar.
	198 L./min.	250 L./min.	356 L./min.	356 L./min.	356 L./min.
	2.850	2.850	2.850	2.850	2.850
	590x290x615 mm.	750x330x670 mm.	730x440x700 mm.	800x520x900 mm.	800x520x900 mm.
	24 Kg.	37 Kg.	40 Kg.	50 Kg.	65 Kg.
	85 Db.	91 Db.	91 Db.	79 Db.	79 Db.
	lubricado oil lubrifié	lubricado oil lubrifié	lubricado oil lubrifié	lubricado oil lubrifié	lubricado oil lubrifié

**TN-705
TN-705 PA**

Taladro neumático reversible
Reversible pneumatic drill
Perçeuse pneumatique réversible

Capacidad broca	Chuck capacity	Capacité foret	10 mm.
R.p.m.	R.p.m.	Tr/min.	1.800
Consumo	Air consumption	Consomation	115 L./min.
Peso Neto	Net Weight	Poids net	1,2 Kg.
Dimensiones	Dimensions	Dimensions	170 x 150 mm.



TN-705 PA

TN-705

TN-705 PA
Portabrocas automático
Automatic chuck
Mandrin autobloquant

TN-705
Portabrocas llave
Key chuck
Mandrin à clé

ANR-141

ANR-141
Atornillador neumático recto
Pneumatic straight screwdriver
Tournevis pneumatique droit

Accionamiento automático, regulación del par exterior
Automatic ON/OFF, external clutch mechanism
Mise en marche et arrêt automatique, réglage du couple extérieur

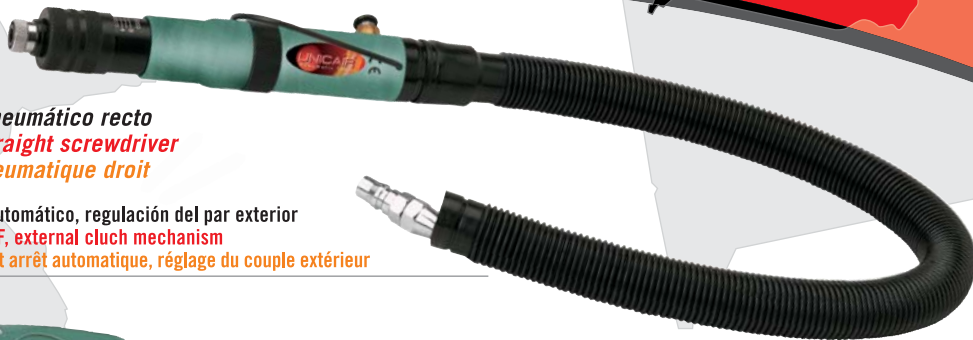

AN-803-833

AN-803-833
Atornillador neumático m/pistola
Pneumatic gun screwdriver
Tournevis pneumatique m/pistolet

Mod. AN-833 con par de apriete exterior
Mod. AN-833 with external clutch mechanism
Mod. AN-833 avec couple de serrage extérieur



ANR-161

ANR-161
Atornillador neumático recto
Pneumatic straight screwdriver
Tournevis pneumatique droit

Regulación del par interna
Internal clutch mechanism
Réglage du couple intérieur



			AN-803-833	ANR-141	ANR-161
Reversible	Reversible	Réversible	x	x	x
Capacidad tornillos	Screw capacity	Capacité de vis	6 mm.	2.5-4 mm.	6 mm.
Puntas de	Hex size of Bit	Pointes de	6,35 mm. (1/4")	6,35 mm. (1/4")	6,35 mm. (1/4")
R.p.m.	R.p.m.	Tr/min	800	1.200	800
Regulación par	Torque	Réglage couple	56/168 kg./cm.	4/16 kg./cm.	56/168 kg./cm.
Consumo	Air consumption	Consomation	120 L./min.	200 L./min.	120 L./min.
Peso	Net weight	Poids net	1,3 Kg.	0,7 Kg.	1,3 Kg.
Dimensiones	Dimensions	Dimensions	200 x 160 mm.	230 x 35 mm.	260 x 50 mm.

LL-241 KIT

Llave impacto 1/2" + Accesorios y maletín
1/2" Impact wrench + Accessories and blow mold case
Clé à choc 1/2" + Accessoires et coffret

LL-241 KIT



LL-245 IND

LL-245 IND
Llave impacto 1/2" industrial
1/2" Industrial impact wrench
Clé à choc 1/2" industrielle

LL-233 KIT

Llave de carraca + Accesorios y maletín
Impact ratchet wrench + Accessories
Clé à cliquet + Accessoires et coffret

LL-233 KIT



LL-261

LL-261
Llave impacto 3/4" industrial
3/4" Industrial impact wrench
Clé à choc 3/4" industrielle



	LL-241 KIT	LL-245 IND	LL-261	LL-233 KIT
Medida cuadrado boca	Square drive	Carré	1/2"	1/2"
Capacidad	Capacity	Capacité	M-16	M-16
Par máximo	Max. Torque	Réglage couple	32 Kg./m.	52 Kg./m.
R.p.m.	R.p.m.	Tr/min	7.000	7.000
Consumo	Air consumption	Consomation	250 L./min.	250 L./min.
Peso	Weight	Poids net	2,2 Kg.	2,7 Kg.
Dimensiones	Dimensions	Dimensions	180 x 200 mm.	240 x 230 mm.
			240 x 230 mm.	260 x 40 mm.



LB-372

Lijadora de banda neumática
Pneumatic belt sander
Ponceuse pneumatique à bande

Medida banda	Belt size	Dimension bande	330 x 10 mm.
R.p.m.	R.p.m.	Tr/min	16.000
Consumo	Air consumption	Consomation	350 L/min.
Peso	Net weight	Poids net	0,8 kg.
Dimensiones	Dimensions	Dimensions	290 x 80 mm.

LB-372



RN-902

Remachadora oleo-neumática
Air hydraulic riveter
Rivéteuse oleo-pneumatique

Ø Remaches	Ø Riveter Sizes	Ø Rivets	2,4 - 3,2 - 4 - 4,8 mm.
Potencia	Power	Puissance	1.045 kg.
Consumo	Air consumption	Consomation	1,5 L.
Peso	Net Weight	Poids net	1,6 kg.
Dimensiones	Dimensions	Dimensions	240 x 170 mm.

RN-902

LRO-317 N

Lijadora roto-orbital neumática
Roto-orbital palm sander
Ponceuse roto-orbital pneumatique



LRO-317N



LRO-318AS N

Lijadora roto-orbital neumática con aspiración
Roto-orbital palm sander with aspiration
Ponceuse roto-orbital pneumatique avec aspiration

LRO-318AS N

	LRO-317 N	LRO-318AS N
Ø Disco lijador	Pad Ø	Ø Disque
150 mm.		150 mm.
R.p.m.	R.p.m.	Tr/min
9.000		9.000
Ø Órbita	Orbital Ø	Ø Circuit vibrant
5 mm.		5 mm.
Consumo	Air consumption	Consomation
250 L/min.		250 L/min.
Peso	Weight	Poids net
1 kg.		1 kg.
Dimensiones	Dimensions	Dimensions
90 x 150 mm.		90 x 150 mm.



AR-111

Amoladora recta neumática
Pneumatic straight die grinder
Meuleuse pneumatique droite

Pinza	Collet	Pince	6 mm.
R.p.m.	R.p.m.	Tr/min	25.000
Consumo	Air consumption	Consomation	115 L/min.
Peso	Net weight	Poids net	0,4 Kg.
Dimensiones	Dimensions	Dimensions	150 x 25 mm.

AR-111



EN-1006

Engrasador industrial neumático
Pneumatic air grease gun
Graisseu industrielle pneumatique

Presión	Pressure	Pression	40:1
Capacidad de depósito	Tank capacity	Capacité du réservoir	400 cc
Peso	Net weight	Poids net	1,6 kg
Presión de trabajo	Operating pressure	Pression de travail	5/8 Bar
Dimensiones	Dimensions	Dimensions	400 x 170 mm.

EN-1006



AS-1002

Aplicador de silicona neumático
Pneumatic gun caulking
Aplicateur pneumatique de silicone

Para cartucho de	Cartridge	Pour cartouche de	Ø 50 x 215 mm.
Presión de trabajo	Operating pressure	Pression de travail	2/4 Bar
Peso	Net weight	Poids net	1,2 Kg.
Dimensiones	Dimensions	Dimensions	320 x 165 mm.

AS-1002



MB-A09

Muelle balancín
Balancer
Ressort de balance

Soporta peso	Capacity	Capacité	0/3 Kg.
Peso	Net weight	Poids net	0,5 Kg.
Dimensiones	Dimensions	Dimensions	180 x 100 mm.

MB-A09

RM-20

Porta-manguera poliuretano
Pu air hose reel
Enrouleur

RM-20



EP-15

Enrollable de pared metalico manguera poliuretano
Pu air hose reel (mural)
Enrouleur mural metalique, tuyau polyuréthane

EP-15



	RM-20	EP-15
Metros	Meters	Metres
20	20	15
Ø	Ø	Ø
8 x 12 mm.	8 x 12 mm.	8 x 12 mm.
Presión	Pressure	Pression
15 bar.	15 bar.	15 bar.
Peso	Net weight	Poids net
5 Kg.	5 Kg.	9 Kg.

EP-812 ER

Espiral de poliuretano 8m. con enchufe rápido y racord
Pu recoil air hose 8m. with plug and coupler
Tuyau polyuréthane 8m. avec prise rapide et raccord

EP-812 ER



R812/50

R812/50

Rollo manguera poliuretano
Pu recoil air hose
Rouleau tuyau polyuréthane



EP-1208/8/15

Espiral de poliuretano de 8 y 15m.
Pu recoil air hose 8 and 15m.
Tuyau polyuréthane 8 et 15m.

EP-1208/8/15



	R812/50	EP-812 ER	EP-1208/8	EP-1208/15
Metros	Meters	Metres:	50	8
Ø	Ø	Ø	8 x 12 mm.	8 x 12 mm.
Roscas macho	Male thread	Filetage mâle	-	-
Presión	Pressure	Pression	15 bar	10 bar
Peso	Net weight	Poids net	3,5 Kg.	0,7 Kg.
Presentación	Presentation	Présentation	-	BLISTER
				BLISTER
				BLISTER



CONJUNTOS FILTROS - LUBRICADOR - REGULADOR
FILTER - LUBRICANT - REGULATOR
ENSEMBLES FILTRES - LUBRIFICATEUR - REGULATEUR

			FRL-400	FRL-300	FRL-200	FR-200
Entrada de aire	Air inlet	Entré d'air	1/2 - 3/8	3/8 - 1/4	1/4	1/4
Caudal	Flow	Débit	6.000 L./min.	4.000 L./min.	3.000 L./min.	3.000 L./min.
Peso	Net weight	Poids net	2,4 kg.	1,6 kg.	0,9 kg.	0,3 kg.



ENCHUFES RACORDS CONNECTIONS RACCORDS CONNEXIONS RACCORDS

MOD.	CÓDIGO CODICE CODE	CÓD. DE BARRAS BAR CODE CODE EAN			
01	M UEC20M 0925002	8435045913893	blister enchufe rapido macho 1/4	blister male coupler 1/4"	blister prise rapide mâle 1/4"
02	H UEC20F 0925003	8435045913909	blister enchufe rapido hembra 1/4	blister female coupler 1/4"	blister prise rapide femelle 1/4"
03	G UEC25H 0925004	8435045913916	blister enchufe rapido manguera Ø8	blister hose coupler Ø8	blister prise rapide tuyau Ø8
04	M MP20M 0925010	8435045913923	blister racord macho 1/4	blister male plug 1/4"	blister raccord mâle 1/4"
05	H MP20F 0925011	8435045913930	blister racord hembra 1/4	blister female plug 1/4"	blister raccord femelle 1/4"
06	G MP25H 0925012	8435045913947	blister adaptador espita-manguera Ø8	blister air hose plug Ø8	blister adaptateur cheville - tuyau Ø8
07	RCF-1/4-5 0999013	8435045911813	racord flexible macho 1/4 - 5	flexible male plug 1/4" - 5	raccord flexible mâle 1/4" - 5
07	RCF-1/4-8 0999016	8435045913152	racord flexible macho 1/4 - 8	flexible male plug 1/4" - 8	raccord flexible mâle 1/4" - 8
08	M T02 0925017	8435045913961	blister "T" macho 1/4	blister "T" male 1/4"	blister "T" mâle 1/4"
09	H T01 0925016	8435045913954	blister "T" hembra 1/4	blister "T" female 1/4"	blister "T" femelle 1/4"

