

# KEYS LLAVES

Unlocking access to the world  
C.12



**We are a people-focused company, leading the global locksmith industry. Our commitment lies in providing expertise, technology, and innovation to create profitable opportunities in the market of opening solutions.**

**We strive to grow with you, embrace change, and constantly evolve.**

Somos una empresa comprometida con las personas, con liderazgo mundial en el sector de la cerrajería. Te acompañamos aplicando conocimiento, tecnología e innovación para generar negocio en soluciones de apertura.

Estamos abiertos a evolucionar contigo.



Open to your  
needs

Abiertos a tus  
necesidades

**JMA**<sup>®</sup>

Opening  
the future

## JMA UNIVERSE

Universo JMA  
JMA unibertsoa  
Univers JMA  
Das JMA-Universum  
Universo JMA  
Świat JMA



### A8 — A17

#### FROM TRADITION TO A GLOBAL PROMINENCE

De la tradición a proyección internacional  
Tradiziotik nazioarteko proiektzioa  
De la tradition à la projection internationale  
Von der Tradition zur internationalen Ausrichtung  
Da tradição à projeção internacional  
Od tradycji po ekspansję międzynarodową

### A18 — A25

#### TOGETHER TO BE THE FIRST

Juntos para ser los primeros  
Elkarrekin, lehenak izateko  
Ensemble pour être les premiers  
Zusammen an der Spitze  
Juntos para sermos os primeiros  
Razem ku pozycji lidera

### A26 — A32

#### QUALITY MATERIALS FOR LONG-LASTING KEYS

Materiales de calidad para llaves que duran toda la vida  
Bizi osoa irauten duten giltzentzako kalitatezko materialak  
Matériaux de qualité pour des clés qui durent toute la vie  
Qualitätsmaterial für Schlüssel, die das ganze Leben halten  
Materiais de qualidade para chaves que duram toda a vida  
Wysokiej jakości materiały do produkcji trwałych kluczy

## JMA KEYS. CATALOGUE

Llaves JMA. Catálogo  
JMA GILTZAK. Katalogoak  
Clés JMA. Catalogue  
JMA-Schlüssel Katalog  
Chaves JMA. Catálogo  
Klucze JMA. Katalog

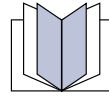

## K01 01 — 122

### CYLINDER AND SPECIAL KEYS

Llaves de serreta y especiales  
Serreta motako giltzak eta bereziak  
Clés plates et spéciales  
Profilzylinder- und Spezialschlüssel  
Chaves de serreta e especiais  
Klucze nacinane i specjalne

## K02 123 — 143

### DIMPLE KEYS

Llaves de puntos  
Puntuen giltzak  
Clés à points  
Bohrmuldenschlüssel  
Chaves de pontos  
Klucze nawiercane

## K03 145 — 147

### TUBULAR KEYS

Llaves tubulares  
Hodi formako giltzak  
Clés tubulaires  
Stiftzylinderschlüssel  
Chaves tubulares  
Klucze rurkowe

## K04 149 — 367

### VEHICLE KEYS + BLADES / KRC

Llaves de vehículos + Espadines /KRC  
Ibilgailuen giltzak + Espadinak / KRC  
Clés de voitures + Lames / KRC  
Fahrzeugschlüssel + Schlüsselbärte /KRC  
Chaves de automóveis + Espadilhas /KRC  
Klucze do pojazdów + Groty /KRC

## K05 369 — 370

### SNAP LOCK KEYS

Llaves de cierre  
Ixe Giltzak  
Clés de fermeture  
Absperrhähne  
Chaves de fecho  
Klucze Nasadowe

## K06 371 — 379

### CROSS - SHAPED KEYS

Llaves de cruz  
Gurutze motako giltzak  
Clés cruciformes  
Kreuzbartschlüssel  
Chaves de cruz  
Klucze krzyżowe

## K07 381 — 453

### MORTICE KEYS

Llaves de Gorja  
Gorja motako giltzak  
Clés à gorge  
Tresor-Schlüssel  
Chaves de gorja  
Klucze zasuwowe

## K08 455 — 458

### WARDROBE KEYS

Llaves artísticas  
Giltza artistikoak  
Clés artistiques/de style  
Artísticas  
Chaves artísticas  
Klucze ozdobne

## K09 459 — 460

### LIFT AND MAIL BOX KEYS

Llaves para casillas  
Kutxatilarako giltzak  
Clés pour casiers  
Künstlerische Schlüssel  
Chaves para caixas  
Klucze do szafek

## BRAND GUIDES. AUTOMOTIVE

Guía de marcas. Automoción  
Marken gida. Automozioa  
Guide des marques. Automobile  
Markenindex. Automobilindustrie  
Índice de marcas. Automóbel  
Spis marek.Samochodowe

### 461 — 514

#### CAR-PICK UP BRANDS

Marcas automovil - camioneta  
Automobila-kamioneta markak  
Marques de voitures - camionnettes  
Automarken - Lieferwagen-Marken  
Marcas de automóveis - pick-ups  
Marki samochodowe - furgonetki

### 515 — 520

#### TRUCK BRANDS

Marcas camión  
Kamioi markak  
Marques de camions  
Lkw-Marken  
Marcas de camion  
Marki pojazdów ciężarowych

### 521 — 540

#### MOTORCYCLE BRANDS

Marcas motocicleta  
Motozikleta markak  
Marques de motos  
Motorradmarken  
Marcas de motocicletas  
Marki motocykli

## USER GUIDE FOR THIS CATALOGUE. BRAND INDEX

Guía de uso de este catálogo.  
Katalogo hau erabiltzeko jarraibideak.  
Guide d'utilisation du catalogue.  
Leitfaden für die Nutzung dieses Katalogs.  
Guia de Utilização deste catálogo.  
Instrukcja korzystania z niniejszego katalogu.

### 542 — 543

#### LEGAL WARNING

Aviso Legal  
Lege-oharra  
Mentions légales  
Impressum  
Aviso legal  
Informacje prawne

### 544 — 545

#### MANUAL OF USE

Manual de uso  
Erabilera-eskuliburua  
Guide d'utilisation  
Bedienungsanleitung  
Manual de Utilização  
Instrukcja obsługi

### 546 — 549

#### DESCRIPTION AND TERMINOLOGY

Descripción y terminología  
Deskribapen eta terminologia  
Description et terminologie  
Beschreibung und Terminologie  
Descrição e terminologia  
Opis i objaśnienie terminów

### 550 — 551

#### SYMBOLS AND NATIONALITIES

Símbolos y nacionalidades  
Ikur eta nazionalitateak  
Symboles et nationalités  
Symbole und Nationalitäten  
Símbolos e nacionalidades  
Symbole i kraje

### 553 — 579

#### BENCHMARK INDEX

Índice de referencias  
Erreferentzia aurkibidea  
Index des références  
Referenzverzeichnis  
Índice de referências  
Spis modeli

### 582 — 592

#### BRAND INDEX

Índice de marcas  
Marken aurkibidea  
Index des marques  
Markenverzeichnis  
Índice de marcas  
Spis marek

# Index



De la tradición a la  
proyección internacional

# From tradition to a global prominence





**TRADITION AND VALUES**

Since our humble artisanal beginnings in 1942, we have maintained our commitment to a traditional model grounded in the metal industry, enriched with enduring human values.

We possess extensive expertise in key manufacturing, bolstered by our own fusion equipment, which provides the flexibility to meticulously craft our products and deliver unparalleled customer service.

**TRADICIÓN Y VALORES**

Desde nuestros inicios más artesanales en 1942, nos hemos mantenido fieles a un modelo tradicional basado en una industria del metal con unos fuertes valores humanos.

Somos expertos en la fabricación de llaves, y también disponemos de nuestro propio equipo de fusión, lo que nos da la flexibilidad para garantizar el cuidado meticuloso de nuestros productos y el más alto nivel de servicio al cliente.

# Our origins stemmed from the metal industry



COMMITMENT TO QUALITY

One of our group's core strengths lies in our unwavering dedication to ensuring the quality of our products.

This is evident through our partnerships with demanding locksmith manufacturers and our presence in the automotive market. Moreover, our quality management system is certified according to IATF 16949:2016 and ISO 9001:2015 standards.

COMPROMISO CON LA CALIDAD

Uno de los puntos fuertes de nuestro grupo es nuestra dedicación a garantizar la calidad de nuestros productos.

Prueba de ello es que suministramos a los fabricantes de cerrajería más exigentes, así como al mercado de la automoción, y que nuestro sistema de gestión de la calidad cuenta con las certificaciones IATF 16949:2016 e ISO 9001:2015.

# Tradition, innovation, and progress





#### INNOVATIVE TECHNOLOGIES

With our extensive experience, we possess the expertise to develop unique solutions that are precise, sophisticated, and reliable, setting us apart in the industry.

Our investments in automated industrial processes and groundbreaking technologies enable us to deliver exceptional products, efficient services, and user-friendly solutions that meet global market demands.

#### TECNOLOGÍAS INNOVADORAS

Nuestros años de experiencia nos han dotado de los conocimientos necesarios para crear soluciones precisas, sofisticadas y de garantía que nos hacen únicos en el sector.

Realizamos inversiones en procesos industriales automatizados y tecnologías innovadoras inventivas que proporcionan productos excelentes, servicios eficaces y soluciones intuitivas. Generamos un negocio global que satisface todas las demandas del mercado.

# Sophisticated and guaranteed solutions



#### IMPACTFUL INITIATIVES

Our keys are manufactured using 100% recycled materials. By managing our own supply of brass and nickel silver, we minimize transportation emissions and reduce our carbon footprint. In addition to sourcing local materials, we are at the forefront of developing lead-free products to minimize their environmental impact.

Our environmental management system is [ISO 14001:2015](#) certified, and our occupational health and safety system complies with [ISO 45001:2018](#) standards.

#### GESTOS QUE MARCAN LA DIFERENCIA

Nuestras llaves se fabrican con materiales 100% reciclados. Gracias a que gestionamos nuestra propia fuente de suministro de latón y alpaca, limitamos las emisiones del transporte, reduciendo nuestra huella de carbono. Además de utilizar materiales Km 0, también estamos a la vanguardia del desarrollo de productos sin plomo con el objetivo de reducir su uso en la producción de llaves y minimizar su impacto medioambiental.

Nuestro sistema de gestión medioambiental cuenta con la certificación [ISO 14001:2015](#), y nuestro sistema de salud y seguridad en el trabajo, con la [ISO 45001:2018](#).

# Dedicated to responsible practices

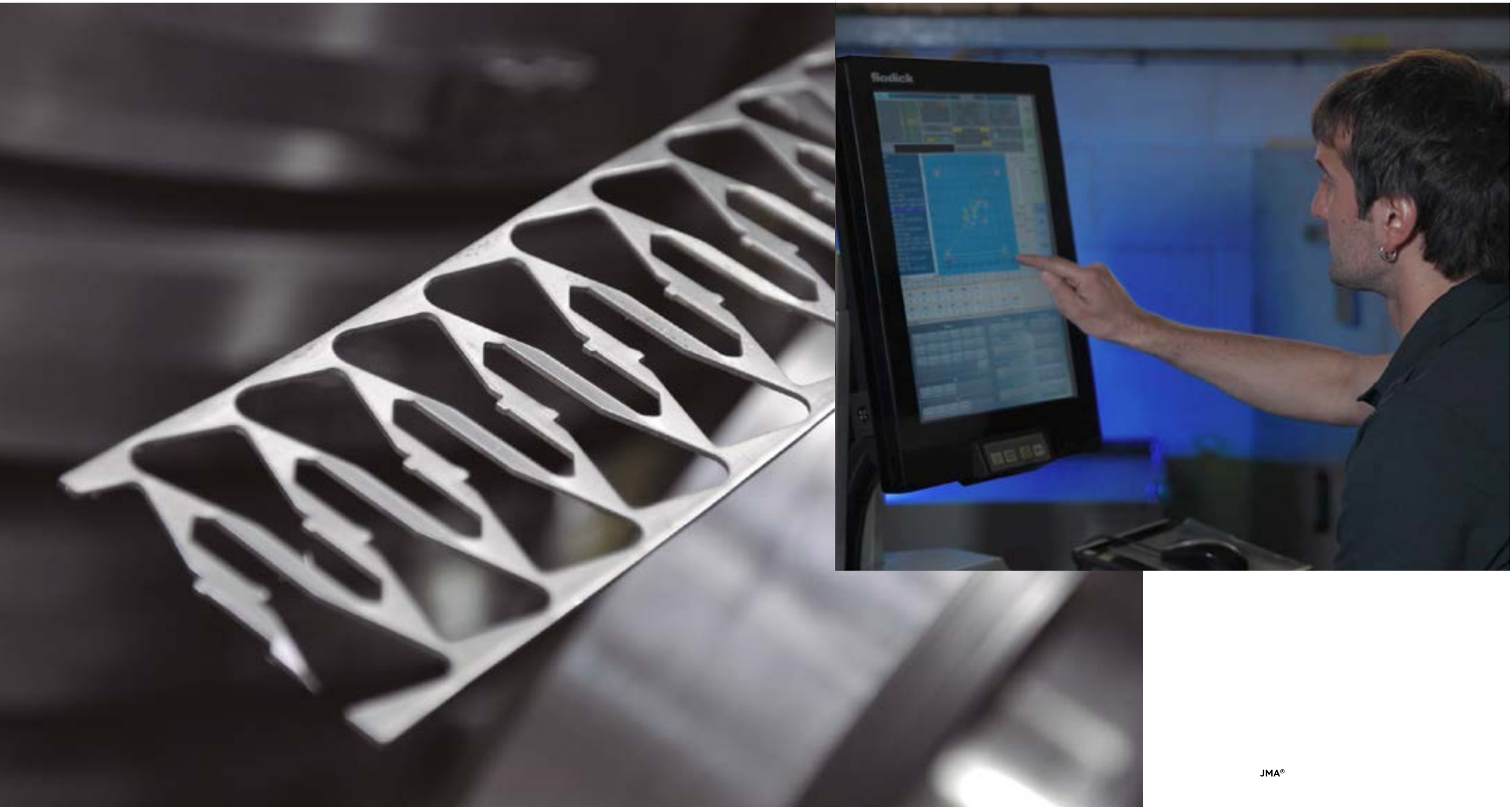



**CONFIDENCE EXPERTS**

We are renowned experts in the global opening solutions industry, offering a wide range of adaptable products and services that are user-friendly.

Thanks to our extensive presence, we instil confidence and make ourselves available wherever you need us. We enhance your experience by embracing new technical and technological challenges.

We invest in the development and manufacturing of tailored solutions specifically for professionals in the locksmith, hardware, and vast supply chain industries.

**ESPECIALISTAS DE CONFIANZA**

Somos expertos en soluciones de apertura global gracias a una amplia gama de productos y servicios adaptables y fáciles de usar.

Nuestra presencia global nos permite generar confianza y presentarnos allí donde nos necesites. Diseñamos una mejor experiencia abordando nuevos retos técnicos y tecnológicos.

Invertimos en el desarrollo y fabricación de soluciones personalizadas para ti, profesional del sector de la cerrajería, la ferretería y la gran cadena de suministro.

# Your trusted professional, always within reach





**EMBRACING NEW POSSIBILITIES**

With our inventive and service-oriented approach, we have become a global industry leader.

Our global strategy spans more than ten countries, with sales offices across Europe, America, Asia, and Africa. We have production facilities in both Europe and America, and our products are sold in over 100 countries worldwide.

**NUEVAS OPORTUNIDADES**

Gracias a nuestra estrategia global, basada en nuestra vocación innovadora y orientada al servicio, somos líderes mundiales del sector.

Estamos presentes en diez países, con oficinas de ventas repartidas por Europa, América, Asia y África, instalaciones de producción tanto en Europa como en América y ventas en más de 100 países de todo el mundo.



# Together, we unlock future opportunities

**JMA®**

**HEADQUARTERS**

SPAIN

**MANUFACTURING**

SPAIN. MEXICO.

**LOGISTICS & DISTRIBUTION**

USA. UK. PORTUGAL. POLAND. MOROCCO. FRANCE. PERU. COLOMBIA.



● DISTRIBUTION CENTERS ● MANUFACTURING PLANTS



**OPEN-MINDEDNESS**

We promote the development of new concepts that offer adaptable, effective, and complementary solutions for the locksmith industry.

Our commitment to innovation is evident in our wide product range, which includes key-cutting machines, remote controls, automotive solutions, and accessories.

Through enhanced networking capabilities, we design reliable solutions that align with your work style, providing confidence at every step.

**ABIERTOS A EVOLUCIONAR**

Promovemos el desarrollo de nuevos conceptos que aporten soluciones adaptables, eficaces y complementarias para la industria de las llaves, así como para máquinas duplicadoras, mandos a distancia, automóviles y accesorios.

Nuestro enfoque innovador puede apreciarse en toda la gama de productos, que incluye máquinas duplicadoras, mandos a distancia, automoción y accesorios.

Con capacidades de conexión en red que nos ayudan a acercarnos a su estilo de trabajo, diseñamos soluciones fiables que inspiran confianza.

# Sustainable growth via innovative solutions.





**EVERY DAY IS THE START OF THE FUTURE**

Our success is built on our unwavering commitment to people. We design products that cater to global opening solutions, meeting the ever-evolving demands of the market.

Your requirements are our top priority, and your future is the driving force behind our daily efforts. We are always nearby, ready to assist you in every possible way.

**EL FUTURO EMPIEZA TODOS LOS DÍAS**

Nuestro compromiso con las personas es la base de nuestro éxito. Diseñamos productos que aportan soluciones globales de apertura para satisfacer las demandas del mercado.

Soluciones que mejoren tu vida respetando el medio ambiente por medio de una planificación cuidadosa, tecnología innovadora y procesos de fabricación sostenibles. Porque tus necesidades son nuestra principal preocupación y tu futuro es la razón por la que empezamos cada día.

# Always prioritising the end user





**Quality  
materials  
for long-  
lasting  
keys**



### THE HIGHEST QUALITY KEYS

In order to create the highest quality keys and provide our customers with unparalleled service, the quality of raw materials is paramount. We meticulously choose the finest materials, tailored to meet the specific requirements and intended usage of our customers.

Our expertise enables us to manufacture versatile and customized keys using different techniques. We source materials like nickel silver, brass, steel, and aluminium from multiple channels to provide tailored solutions for each customer's unique needs. The integration of our foundry within the Altuna group gives us a competitive advantage, allowing us to develop new materials and enhance service quality.

### LLAVES DE LA MÁS ALTA CALIDAD

Para producir las mejores llaves y ofrecer a nuestros clientes el mejor servicio, las materias primas son esenciales. Dependiendo de los requisitos de nuestros clientes y del uso previsto, podemos producirlas utilizando diferentes técnicas.

Nuestra capacidad para fabricar llaves utilizando materiales como alpaca, latón, acero y aluminio de diversas fuentes de suministro, nos permite ofrecer soluciones específicas para cada necesidad de nuestros clientes. Disponer de una fundición dentro del grupo Altuna también nos proporciona una ventaja competitiva en el desarrollo de nuevos materiales y en la calidad del servicio.

# We meticulously select the raw material

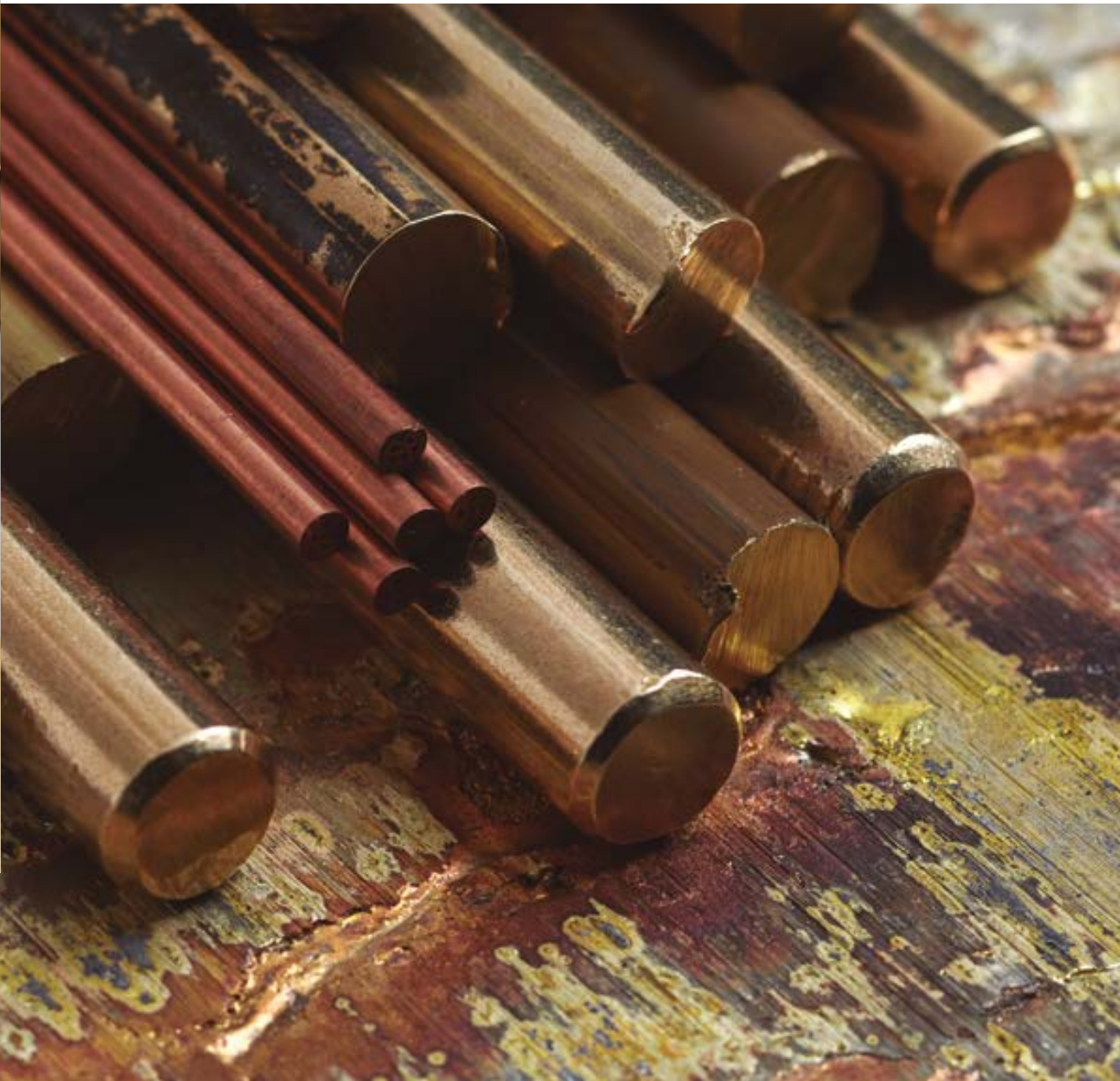



**EXUDING SOPHISTICATION AND EXCELLENCE**

A hallmark of our key production lies in the meticulous attention to detail, showcased by the impeccable polished finish adorning each and every key in our extensive catalogue.

We take great pride in overseeing every aspect of our work, ensuring the highest standards of quality and sophisticated solutions.

**SOFISTICACIÓN Y AUTOEXIGENCIA**

Nuestra seña de identidad, que se transmite en la creación de todas las familias de llaves, es un acabado pulido brillo muy cuidado.

Hemos sido reconocidos por supervisar meticulosamente cada aspecto de nuestro trabajo, al tiempo que ofrecemos las soluciones más completas y sofisticadas disponibles.

# Polished and lustrous finish







# Keys

**JMA KEYS. CATALOGUE**

Llaves JMA. Catálogo  
JMA giltzak. Katalogoak  
Clés JMA. Catalogue  
JMA-Schlüssel Katalog  
Chaves JMA. Catálogo  
Klucze JMA. Katalog





# Family keys

## Familias de llaves



**K01** 01 – 122  
CYLINDER AND SPECIAL KEYS

Llaves de serreta y especiales  
Serreta motako giltzak eta bereziak  
Clés plates et spéciales  
Profilylinder- und Spezialschlüssel  
Chaves de serreta e especiais  
Klucze nacinane i specjalne



**K02** 123 – 143  
DIMPLE KEYS

Llaves de puntos  
Puntuen giltzak  
Clés à points  
Bohrmuldenschlüssel  
Chaves de pontos  
Klucze nawiercane



**K03** 145 – 147  
TUBULAR KEYS

Llaves tubulares  
Hodi formako giltzak  
Clés tubulaires  
Stiftzylinderschlüssel  
Chaves tubulares  
Klucze rurkowe



**K04** 149 – 367  
VEHICLE KEYS + BLADES / KRC

Llaves de vehículos + Almas /KRC  
Ibilgailuen giltzak + Espadinak / KRC  
Clés de voitures + Lames / KRC  
Fahrzeugschlüssel + Schlüsselbärte /KRC  
Chaves de automóveis + Espadilhas /KRC  
Llaves de vehículos + Almas /KRC



**K05** 369 – 370  
SNAP LOCK KEYS

Llaves de cierre  
Ixe Giltzak  
Clés de fermeture  
Absperrhähne  
Chaves de fecho  
Klucze Nasadowe



**K06** 371 – 379  
CROSS - SHAPED KEYS

Llaves de cruz  
Gurutze motako giltzak  
Clés cruciformes  
Kreuzbartschlüssel  
Chaves de cruz  
Klucze krzyżowe



**K07** 381 – 453  
MORTICE KEYS

Llaves de Gorja  
Gorja motako giltzak  
Clés à gorge  
Tresor-Schlüssel  
Chaves de gorja  
Klucze zasuwowe



**K08** 455 – 458  
WARDROBE KEYS

Llaves artísticas  
Giltza artistikoak  
Clés artistiques/de style  
Artísticas  
Chaves artísticas  
Klucze ozdobne



**K09** 459 – 460  
LIFT AND MAIL BOX KEYS

Llaves para casillas  
Kutxatilarako giltzak  
Clés pour casiers  
Künstlerische Schlüssel  
Chaves para caixas  
Klucze do szafek

# Distinctive keys\*

Llaves especiales



## COINED

Grabado  
Grabatua  
Gravure  
Gravieren  
Gravação  
Frezowane



## ALUMINIUM

Aluminio  
Aluminioa  
Aluminium  
Aluminium  
Alumínio  
Aluminium



## WINDCOLOR



## FASHION\*\*

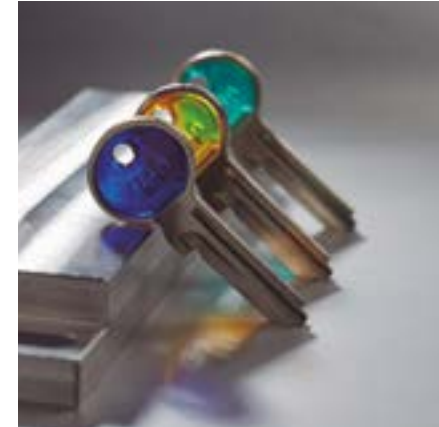

## COLORMATIC

\* **Check References.** Consultar Referencias. Erreferentziak Kontsultatu. Voir Références. Referenzen Konsultieren. Consultar referências. Sprawdź referencje.

\*\* **Customizable models.** Modelos personalizables. Modelo pertsonalizatuak. Modelos personalizables. Modèles personnalisables. Modelos Personalizáveis. Konfigurowalne modele.



# CYLINDER AND SPECIAL KEYS

Llaves de serreta y especiales  
Serreta motako giltzak eta bereziak

Clés plates et spéciales  
Profilzylinder- und Spezialschlüssel

Chaves de serreta e especiais  
Klucze nacinate i specjalne



FOR: 45®		FOR: 303®		FOR: 333®	

FOR: 3M®	FOR: A.M. BARAS®	FOR: ABA®	FOR: ABC®	

FOR: ABC®		FOR: ABLOY®			

FOR: ABLOY®	FOR: ABSA®			

FOR: ABSA®		FOR: ABUS®		

FOR: ABUS®				

Concerning the marks and commercial denominations see legal warning.  
 Concerniente a las marcas y denominaciones comerciales ver aviso legal.  
 Marka eta izendapen komertzialiei dagokienez, ikus lege-oharra.  
 Concernant les marques et dénominations commerciales voir la note dans l'index.

**JMA®** Opening the future

**JMA®** Opening the future

Beziehen auf die Marke und Handelsname sehen sie die Notiz im Impressum.  
 Relativamente às marcas e denominações comerciais, ver aviso legal.  
 Jeśli chodzi o znaki i nazwy handlowe, patrz Informacje prawne.

FOR: ABUS®

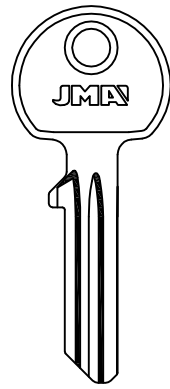
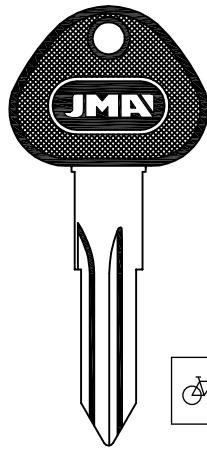
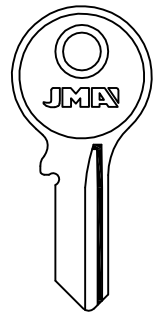
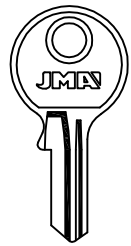

ABU-11 ABU-11D

ABU-13 ABU-13D

Z71....1-1043  
Z72....1-1043  
ABU-18.P ABU-18D.P

Z71....1-1043  
Z72....1-1043  
ABU-19D

FOR: CISA®

FOR: ANCHOR®-BURG®  
FOR: GUITTEL®-IMP®-ROYAL®

FOR: BUFFO®

FOR: BUFFO®

FOR: ABUS®

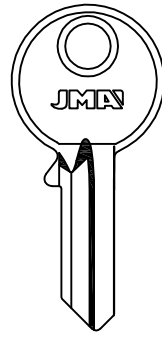
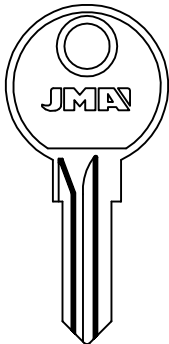
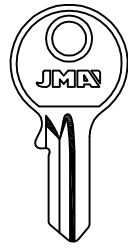
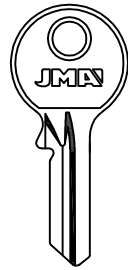
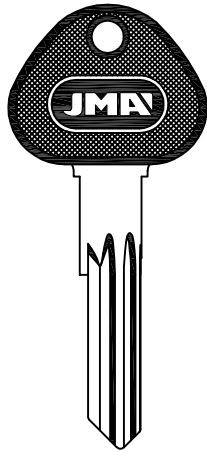

Z71....1-1043  
Z72....1-1043  
ABU-19.P ABU-19D.P

ABU-22D

ABU-23D

ABU-24D

ABU-25D

FOR: BUFFO®

FOR: CISA®

FOR: ABUS®

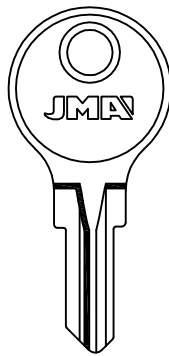
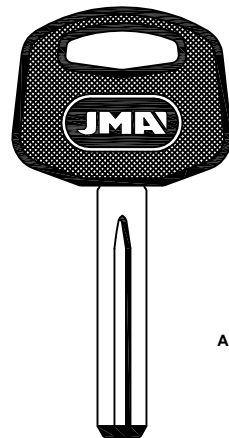
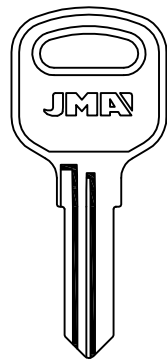
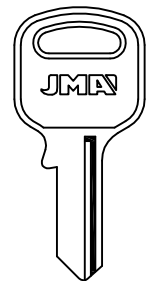
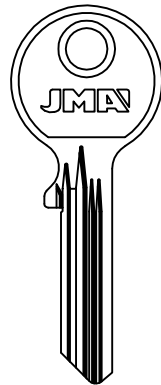

ALP.

ABU-26D

ABU-27 ABU-27D

ABU-28

ABU-29.P

ABU-30 ABU-30D

FOR: WÜRTH®

FOR: CISA®

FOR: ARMSTRONG®-BUFFO®

FOR: PLUS®

FOR: ABUS®

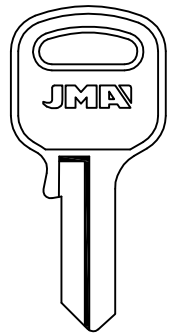
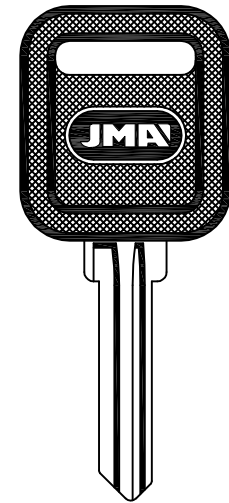
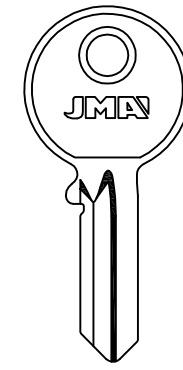
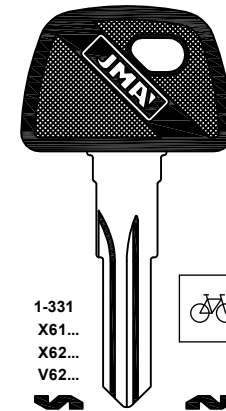
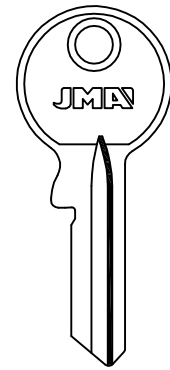

ABU-32D

1-331  
X61...  
X62...  
V62...  
ABU-35.P ABU-35D.P

1-331  
V61...  
V62...  
ABU-36.P

ABU-38D

ABU-39.P

ABU-45 ABU-40  
FOR: ANCHOR®-BURG®-GUITTEL®  
FOR: IMP®-ROYAL®

FOR: ANCHOR®-IMP®

FOR: BUFFO®

FOR: ABUS®

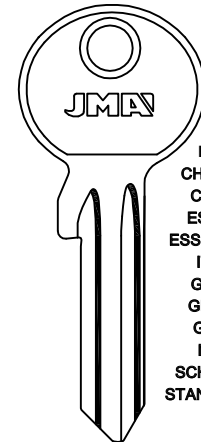

ABU-41 ABU-41D

ABU-68

ABU-92 ABU-92D

ABU-99D/1

ABU-99D/2

ABU-99D/3

FOR:  
CHAVO®  
CISA®  
ESCO®  
ESSENDIA®  
ITO®  
GEFI®  
GETE®  
GTV®  
NB®  
SCHUCO®  
STANDARD®

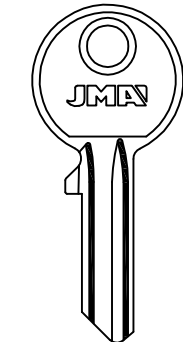

...1-342  
EF...1-724  
B...1-342  
EE...1-724  
ABU-42 ABU-42D

FOR: BUFFO®-CISA®

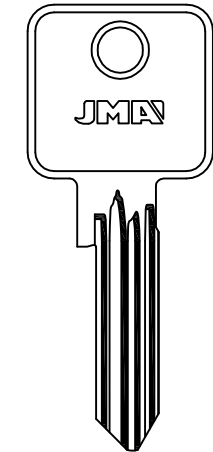

\* LAT.

ABU-58D  
K1D  
ABU-70  
K1S  
ABU-70D

ABU-77

ABU-80

ABU-83

X4S  
ABU-85

C83  
ABU-100

FOR: CISA®

FOR: ABUS®

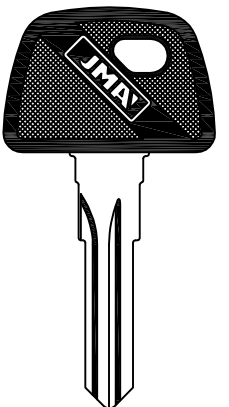
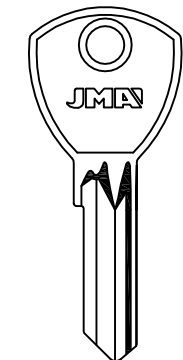
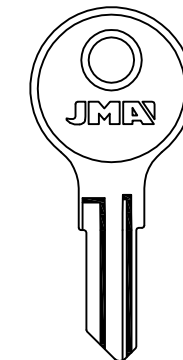
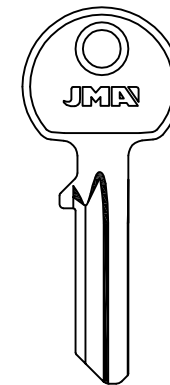
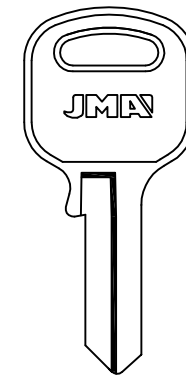

ABU-60 ABU-50

ABU-51D

ABU-54 ABU-54D

ABU-57 ABU-57D

U72  
ABU-64.P  
W71  
ABU-65.P

FOR: ANCHOR®-JMP®

Concerning the marks and commercial denominations see legal warning.  
Concerniente a las marcas y denominaciones comerciales ver aviso legal.  
Marka eta izendapen komertzialiei dagokienez, ikus lege-oharra.  
Concernant les marques et denominations commerciales voir la note dans l'index.

**JMA** Opening the future

**JMA** Opening the future

Beziehen auf die Marke und Handelsname sehen Sie die Notiz im Impressum.  
Relativamente às marcas e denominações comerciais, ver aviso legal.  
Jeśli chodzi o znaki i nazwy handlowe, patrz Informacje prawne.

K01 / 5

FOR: ABUS®

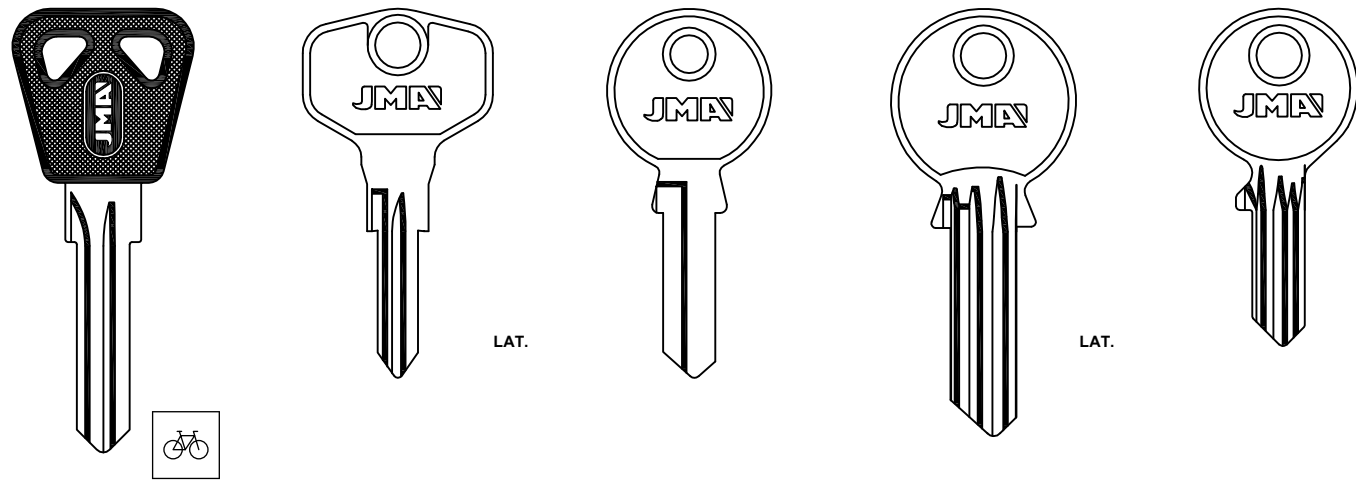

ABU-72.P

ABU-73D

ABU-75D

004  
ABU-78

AL  
ABU-79

FOR: GE GE®

FOR: ABUS®

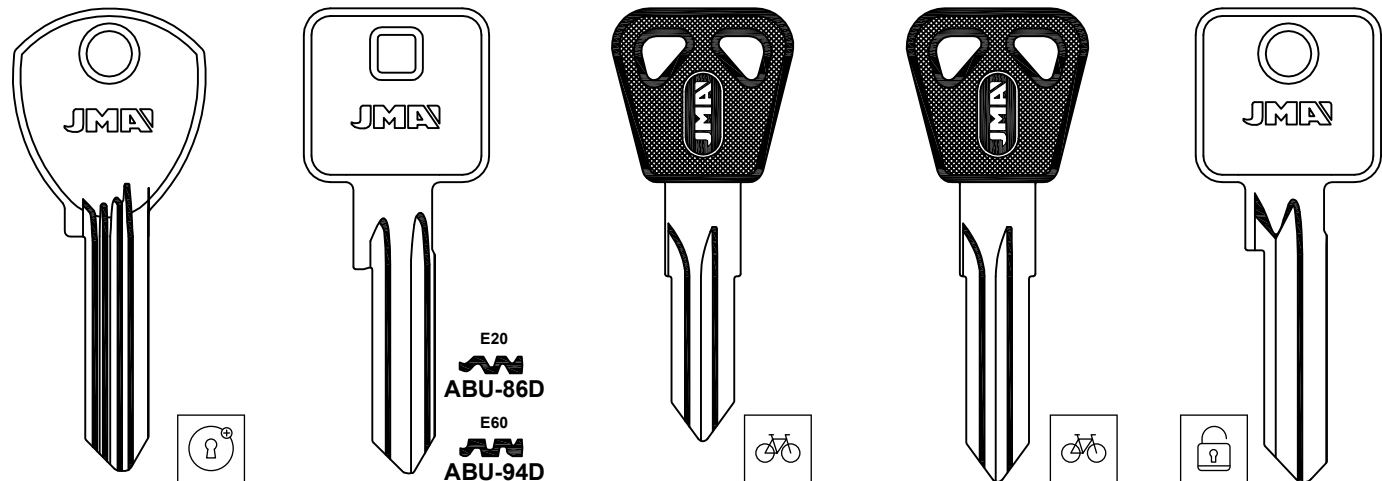

ABU-84D

ABU-17

E20  
ABU-86D  
E60  
ABU-94D

NW52  
ABU-87.P

NW72  
ABU-88.P

SERIE 90/50  
ABU-89D

FOR: ABUS®

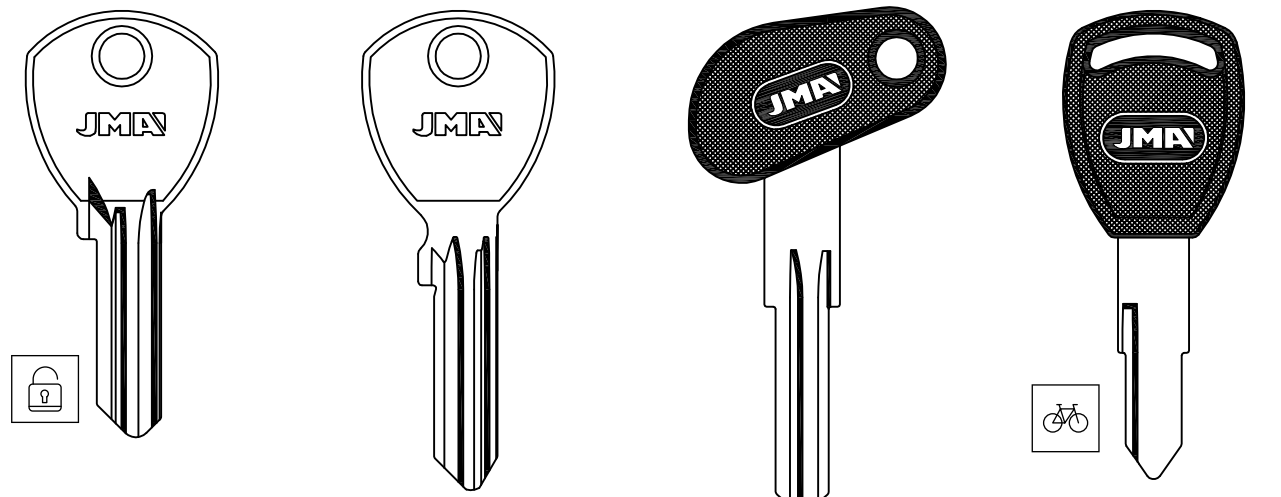

SERIE 64TI  
ABU-90

ABU-93

T82  
ABU-101.P

N6  
ABU-103D.P

FOR: CISA®

FOR: ABUS®

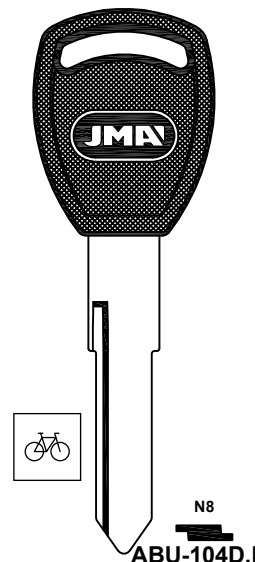

N8  
ABU-104D.P

FOR: ADAMSRITE®

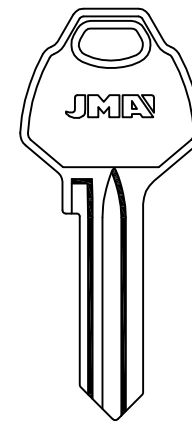

ADS-1D

FOR: AEP®

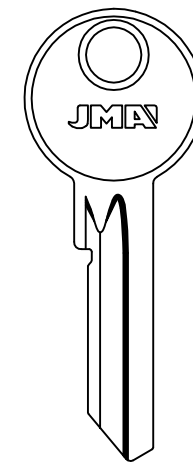

AEP-1D

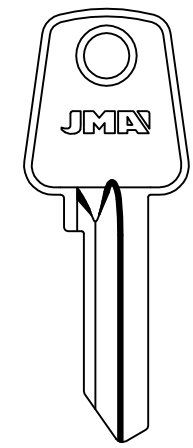

AEP-2D

FOR: AGA®



T1  
AGA-11

FOR: AGA®

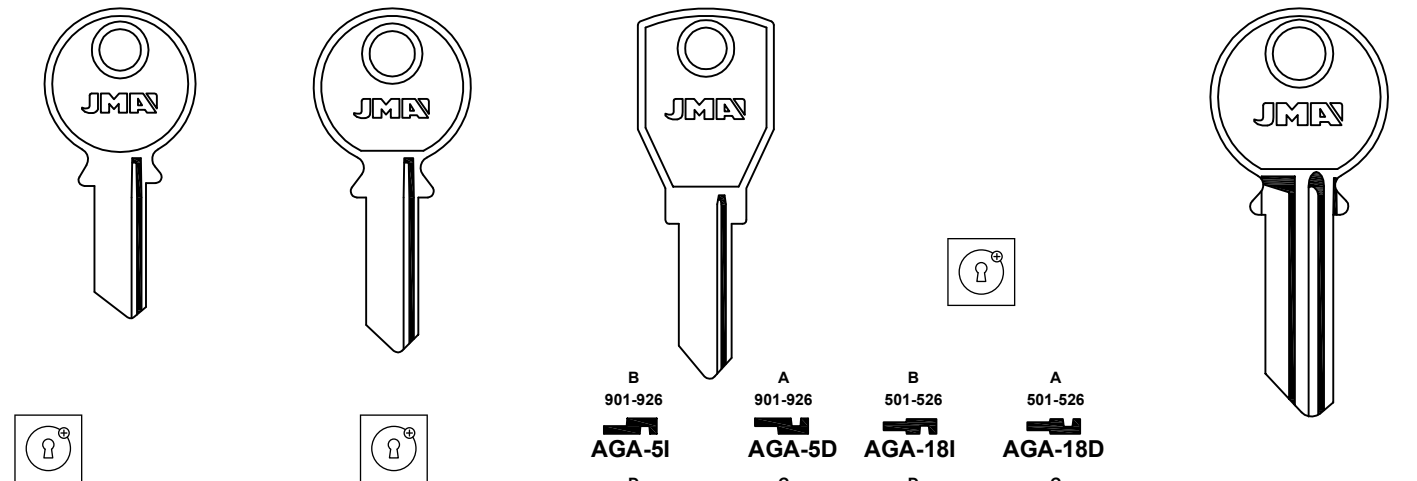

AGA-3I

AGA-4I

AGA-4D

B  
901-926  
AGA-5I

A  
901-926  
AGA-5D

B  
501-526  
AGA-18I

A  
501-526  
AGA-18D

D  
901-926  
AGA-6I

C  
901-926  
AGA-6D

D  
501-526  
AGA-19I

C  
501-526  
AGA-19D

AGA-7

FOR: FAC® -KEMEN® -KIFER® -RONEO®

FOR: MECALUX® -SUYOKA®

FOR: JOVI®

FOR: AGA®

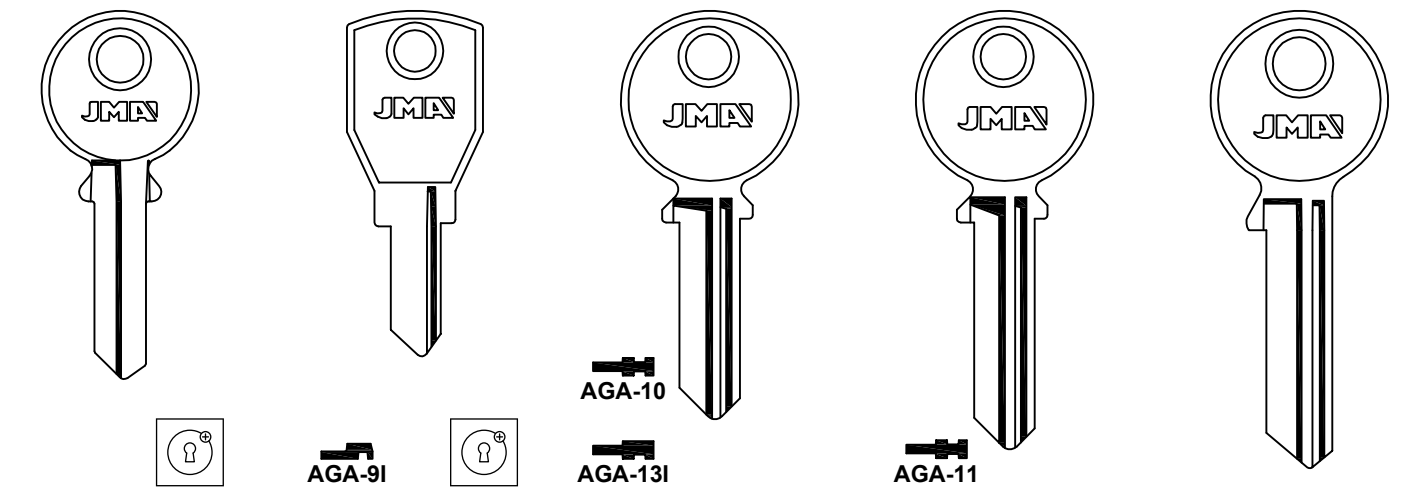

AGA-8D

AGA-9I

AGA-10

AGA-13I

AGA-11

AGA-14D  
FOR: GARI®

AGA-15

FOR: GOYAL® -KEMEN®

FOR: ARREGUI® -ALFA® -GARI®

FOR: GARI®

FOR: ORENGO® -RUTALCHI® -SERRALLER®

Concerning the marks and commercial denominations see legal warning.  
Concerniente a las marcas y denominaciones comerciales ver aviso legal.  
Marka eta izendapen komertzialiei dagokienez, ikus lege-oharra.  
Concernant les marques et dénominations commerciales voir la note dans l'index.

**JMA**® Opening the future

**JMA**® Opening the future

Beziehen auf die marke und handelsname sehen sie die notiz im Impressum.  
Relativamente às marcas e denominações comerciais, ver aviso legal.  
Jeśli chodzi o znaki i nazwy handlowe, patrz Informacje prawne.

**K01** / 17

**FOR: AGA®**

AGA-16I      AGA-20      P,1      P,1      11I      12I  
 AGA-24I      AGA-24D      AGA-51      AGA-52

FOR: SERRALLER®

**FOR: AGA®**

15I  
 AGA-57

**FOR: AGB®**

AGB-1      AGB-1D

FOR: OIAUS®

**FOR: AGC®**

AGD-1      AGD-2

FOR: OIAUS®

**FOR: AGE®**

AGE-11      AGE-2D

**FOR: AGUIA®**

701      701      706      706  
 AG-11      AG-1D      AG-61      AG-6D  
 703      703      708      708  
 AG-31      AG-3D      AG-81      AG-8D  
 704      704      709      709  
 AG-41      AG-4D      AG-91      AG-9D  
 705      705      710      710  
 AG-51      AG-5D      AG-101      AG-10D      AG-11      AG-11D

**FOR: AGUT®**

AGU-1D

**FOR: AIZPUTE®**

AIZ-1      AIZ-2D

**FOR: ALDRIDGE®**

AL-11      AL-2      AL-3

FOR: ASEC®      FOR: ASEC®

**FOR: ALE®**

ALE-1      ALE-1D

**FOR: ALFA®**

ALF-1

ALF-8	ALF-8D	ALF-15	ALF-22D	ALF-29	ALF-36
ALF-7		ALF-14D	ALF-21	ALF-28	ALF-35
ALF-6		ALF-13D	ALF-20	ALF-27	ALF-34
ALF-5		ALF-12D	ALF-19	ALF-26	ALF-33
ALF-4		ALF-11D	ALF-18	ALF-25	ALF-32D
ALF-3	ALF-10	ALF-10D	ALF-17	ALF-24	ALF-31
ALF-2			ALF-9	ALF-16	ALF-23

FOR: GE GE®

**FOR: ALIANCA®**

ALC-1D

**FOR: ALPHA®**

ALP-11      ALP-1D      ALP-2      ALP-2D      ALP-3      ALP-4D

S...301-600      S...301-600

FOR: FEB®      FOR: FEB®

Concerning the marks and commercial denominations see legal warning.  
 Concerniente a las marcas y denominaciones comerciales ver aviso legal.  
 Marka eta izendapen komertzialiei dagokienez, ikus lege-oharra.  
 Concernant les marques et dénominations commerciales voir la note dans l'index.

**JMA®** Opening the future

**JMA®** Opening the future

Beziehen auf die marke und handelsname sehen sie die notiz im Impressum.  
 Relativamente às marcas e denominações comerciais, ver aviso legal.  
 Jeśli chodzi o znaki i nazwy handlowe, patrz Informacje prawne.

FOR: ALPHA®  ALP-5D	FOR: ALTAY®  ATA-1 ATA-1D	FOR: AMARU®  AMA-1 AMA-1D FOR: AL®	FOR: AMERICAN LOCK®  AME-1 AME-2 LAT.
---------------------------	------------------------------------	--	---

FOR: ANKER®				
 ANK-3 FOR: ODA®	 ANK-4	 ANK-6 K...111-888 ... K... 1011-7077 E... F... B... 1-2-3-4-5-6-7	 ANK-17 ANK-65	 ANK-47D K...111-888 ... K... 1011-7077 E... F... B... 1-2-3-4-5-6-7

FOR: AMERICAN LOC.®  AME-4 LAT.	FOR: AMIG®				
	 AMG-1 1-15 / 1-20	 AMG-2D 1-25	 AMG-3D 1-30	 AMG-4D 1-40	 AMG-5D 1-50

FOR: ANTA®  ANA-1 ANA-1D FOR: VEGA®	FOR: APECS®  AP-2D FOR: APEX® - APEKS®	FOR: ARCU®  ARC-17.P ARC-17D.P ALP.	FOR: AREL®  ARE-1D	FOR: ARFE®  ARFE-1I ARFE-1D
---	---	---	--------------------------	--------------------------------------

FOR: AMIG®  AMG-13D MOD.9700 FOR: FAC® -GAON® -KALE® -TURSAN®	FOR: ANCHOR®  ANC-1D FOR: ANKERSLOT®	FOR: ANCHOR®  ANC-2	FOR: ANKER®  ANK-1 FOR: ANCHOR® -LITTO® -ODA®	FOR: ANKER®  ANK-2 FOR: ODA®
---	---	---------------------------	--	---------------------------------------

FOR: ARFE®  ARFE-3D	FOR: ARMSTRONG®			FOR: AROUCA®  ARO-1D
	 ARN-1	 ARN-2	 ARN-2D	 ARN-3
			 ARN-3D	
			FOR: ABUS®	

Concerning the marks and commercial denominations see legal warning.  
 Concerniente a las marcas y denominaciones comerciales ver aviso legal.  
 Marka eta izendapen komertzialiei dagokienez, ikus lege-oharra.  
 Concernant les marques et dénominations commerciales voir la note dans l'index.

**JMA** Opening the future

**JMA** Opening the future

Beziehen auf die marke und handelsname sehen sie die notiz im Impressum.  
 Relativamente às marcas e denominações comerciais, ver aviso legal.  
 Jeśli chodzi o znaki i nazwy handlowe, patrz Informacje prawne.

**FOR: ARREGUI®**

ARR-1  
ARR-2  
ARR-3  
ARR-8

AR-1D  
AR-4IP  
AR-4DP

FOR: INDAUX®

**FOR: ARROW®**

\* LAT.  
LAT.

ARR-7D  
ARR-9D

ARR-1D

**FOR: ARSENEVSK®**

ARS-1D

FOR: DOMINION LOCK®-FORT®-LG®

**FOR: ASEC®**

ASC-1D

**FOR: ASIA®**

ASI-1

FOR: CINA®

**FOR: ASPA®**

ASP-1D

**FOR: ASSA®**

\* LAT.

TL

AS-4D  
AS-5D  
AS-6D  
AS-7D

14-09  
AS-8D  
14-25  
AS-9D

05-04  
AS-5D  
14-01  
AS-6D  
05-13  
AS-7D

11-01  
AS-13D  
11-12  
AS-14D  
11-32  
AS-15D  
11-08  
AS-16D  
05-14  
AS-18D  
11-33  
AS-11D  
11-14  
AS-12D  
TM  
AS-25D  
\* AS-28

**FOR: ASSA®**

FOR: ABC®  
0 AL 9

21301  
AS-3I

21201  
AS-3D

21....  
0001-9999  
AS-19D

AS-20D

AS-22

AS-23

AS-23D

LAT.

FOR: TEKA®

**FOR: ASSA®**

AS-30D

28,4 mm.

34,5 mm.

AS-A5  
AS-E5  
AS-M5  
AS-P5

AS-B5  
AS-F5  
AS-G5  
AS-N5

AS-A7  
AS-E7  
AS-L7  
AS-M7  
AS-P7  
AS-S7

AS-B7  
AS-F7  
AS-K7  
AS-G7  
AS-N7  
AS-R7

AS-RK7  
AS-RC7  
AS-RE7  
AS-RG7  
AS-RH7

AS-RA7  
AS-RB7  
AS-RD7  
AS-RF7  
AS-RN7

760A  
760B  
760RK  
760RB  
760RC  
760RD  
760RE  
760RC  
760RG  
760RH  
760RN

**FOR: ASSA®**

29,7 mm.

AS-AK5  
AS-AL5  
AS-AM5  
AS-BK5

AS-EK5  
AS-EL5  
AS-EM5  
AS-FK5

AS-DK5  
AS-DL5  
AS-DM5

AS-GK5  
AS-GL5  
AS-GM5  
AS-MM5

AS-NN5  
AS-V5  
AS-U5

AS-T5  
AS-W5

**FOR: ASSA®**

35,7 mm.

AS-AK7  
AS-AL7  
AS-AM7  
AS-BK7  
AS-BL7

AS-EK7  
AS-EL7  
AS-EM7  
AS-FK7  
AS-FL7

AS-DK7  
AS-DL7  
AS-DM7  
AS-GG7  
AS-KK7

AS-BM7  
AS-FM7  
AS-GK7  
AS-GL7  
AS-GM7  
AS-MM7

AS-D7  
AS-U7  
AS-V7  
AS-Z7

AS-H7  
AS-W7  
AS-T7  
AS-X7

760D  
760H  
760U  
760W  
760V  
760T  
760N  
760PP  
760RR  
760SS  
760Z  
760X

Concerning the marks and commercial denominations see legal warning.  
 Concerniente a las marcas y denominaciones comerciales ver aviso legal.  
 Marka eta izendapen komertzialiei dagokienez, ikus lege-oharra.  
 Concernant les marques et denominations commerciales voir la note dans l'index.

**JMA®** Opening the future

**JMA®** Opening the future

Beziehen auf die marke und handelsname sehen sie die notiz im Impressum.  
 Relativamente às marcas e denominações comerciais, ver aviso legal.  
 Jeśli chodzi o znaki i nazwy handlowe, patrz Informacje prawne.





FOR: ASSA®

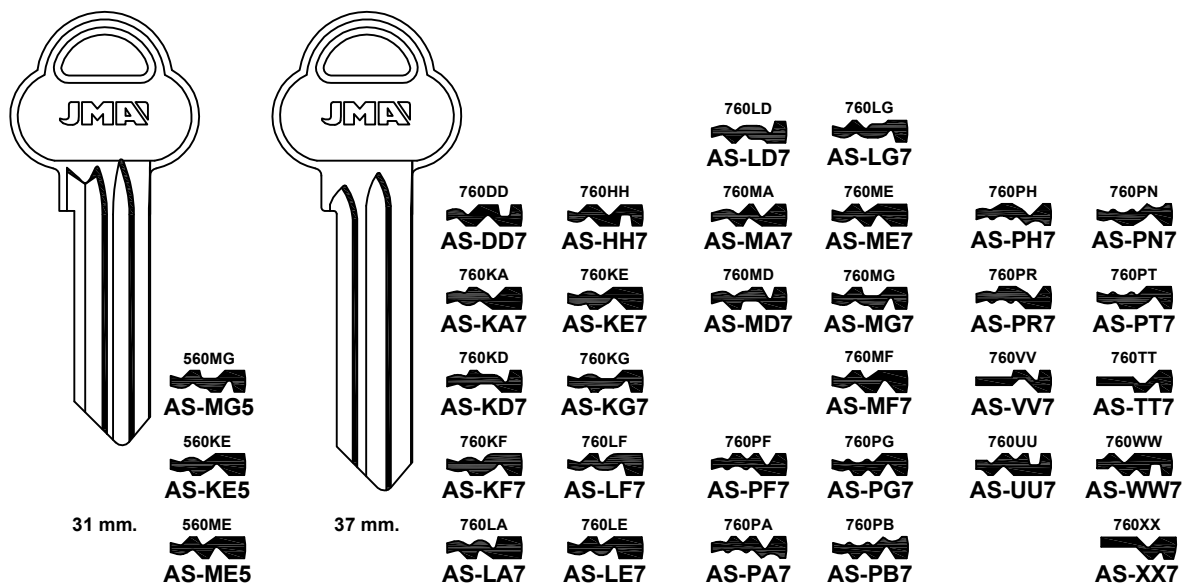

FOR: ATLAS®

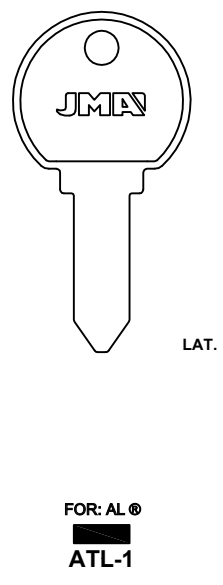

FOR: AZBE®

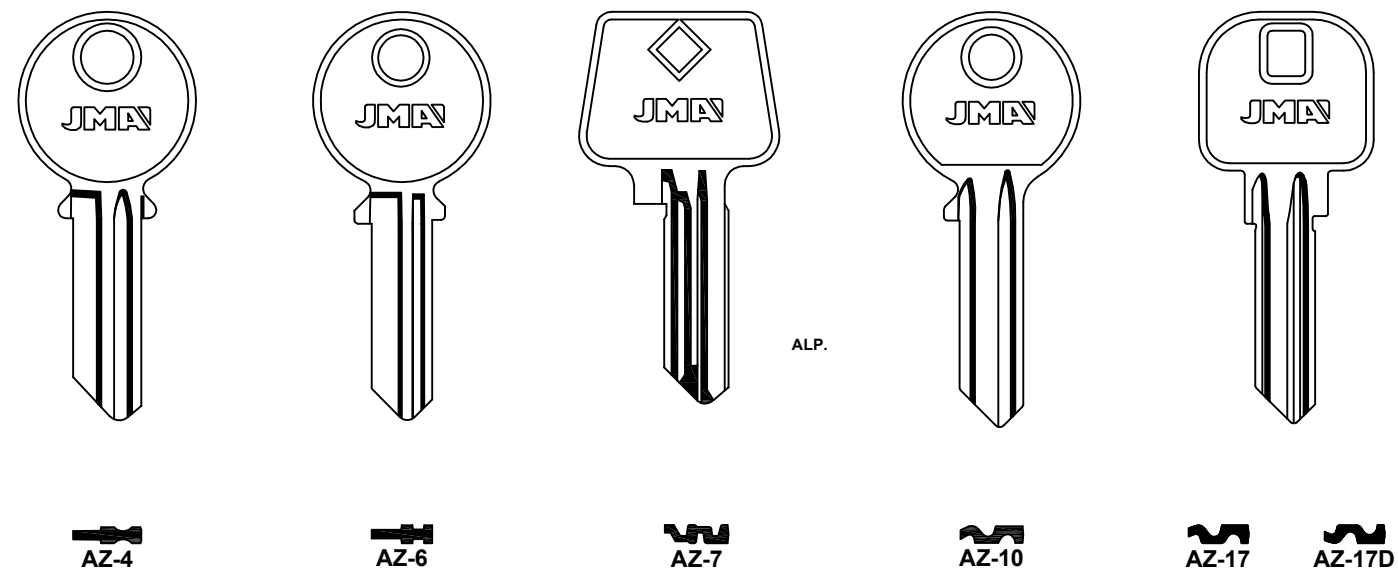

FOR: AUMON®

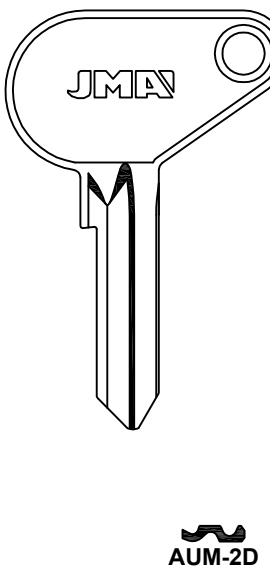

FOR: AVANGARD®

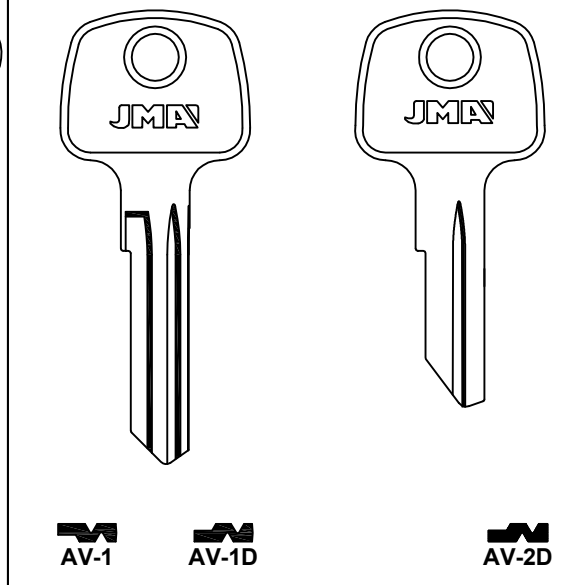

FOR: AXA®

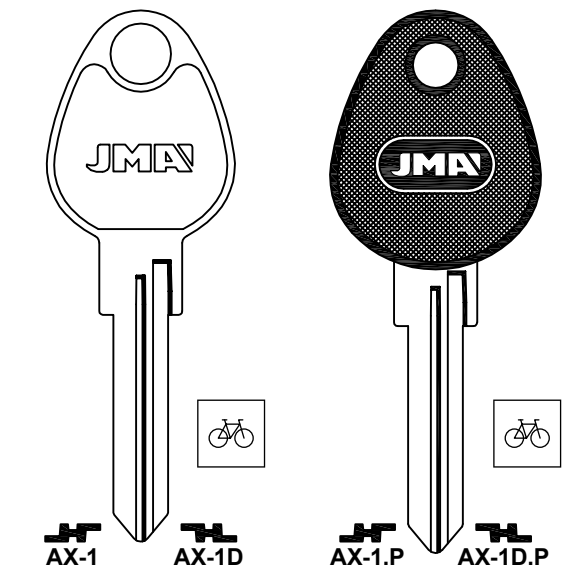

FOR: AZBE®

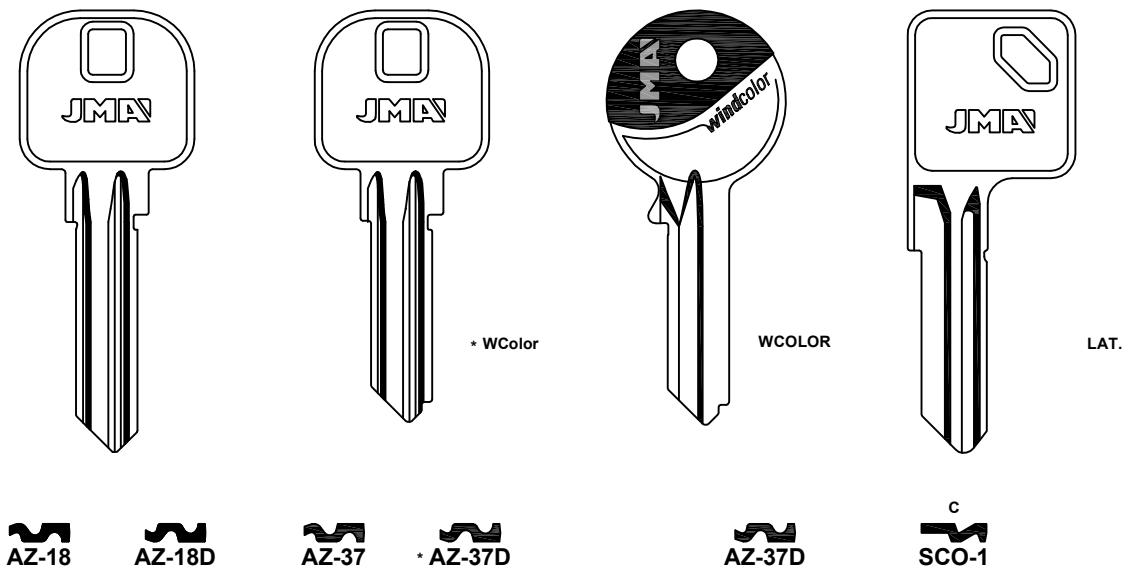

FOR: AZKOYEN®

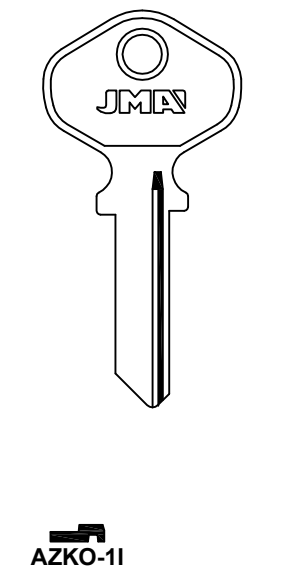

FOR: AXA®

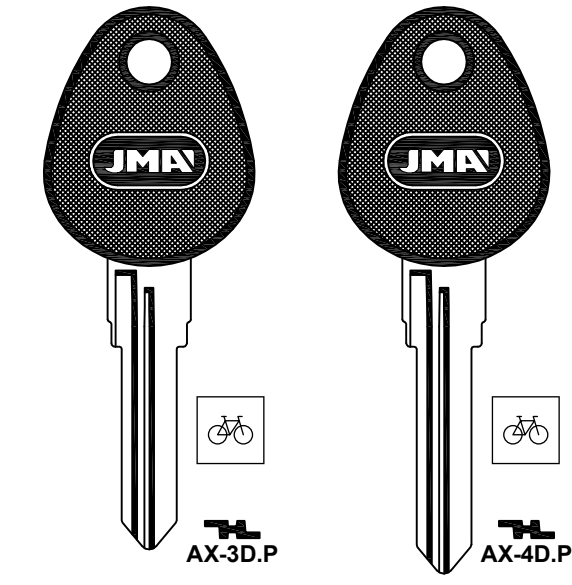

FOR: AZBE®

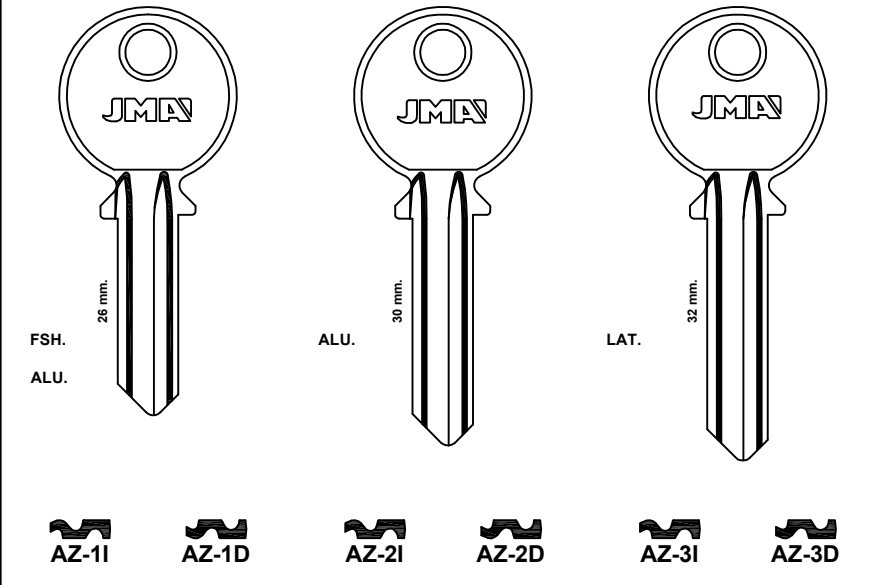

FOR: B+D®

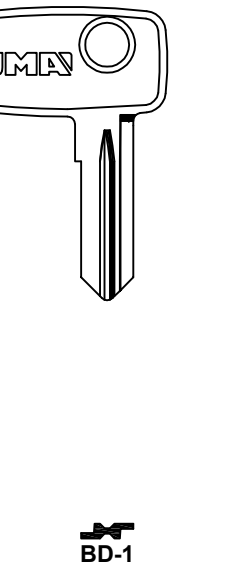

FOR: BAB®

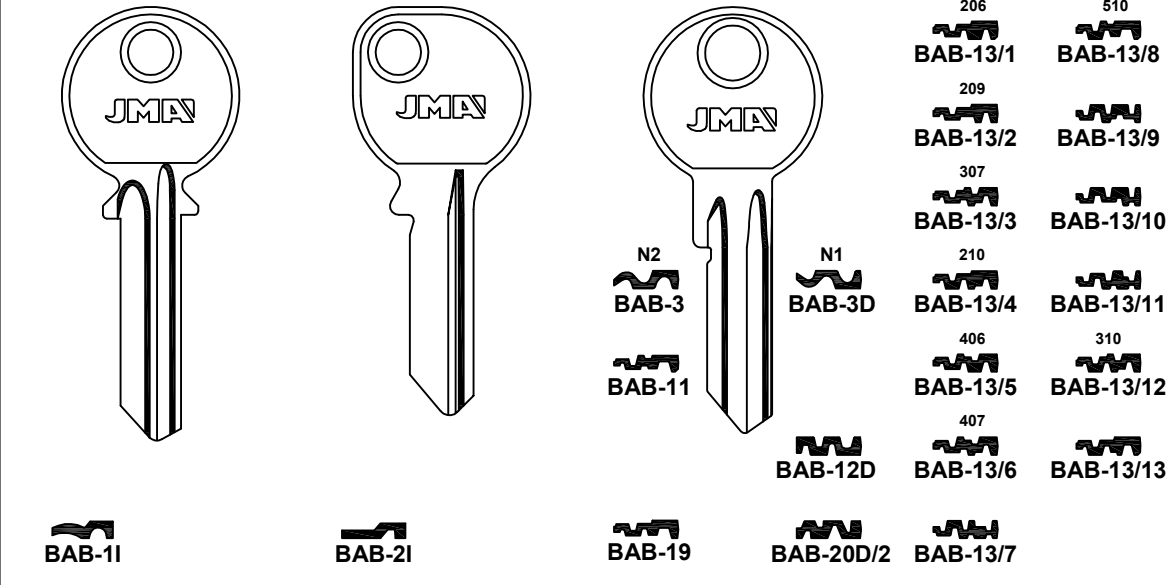

Concerning the marks and commercial denominations see legal warning.  
 Concerniente a las marcas y denominaciones comerciales ver aviso legal.  
 Marka eta izendapen komertzialiei dagokienez, ikus lege-oharra.  
 Concernant les marques et denominations commerciales voir la note dans l'index.



Beziehen auf die marke und handelsname sehen sie die notiz im Impressum.  
 Relativamente às marcas e denominações comerciais, ver aviso legal.  
 Jeśli chodzi o znaki i nazwy handlowe, patrz Informacje prawne.

FOR: BAB®

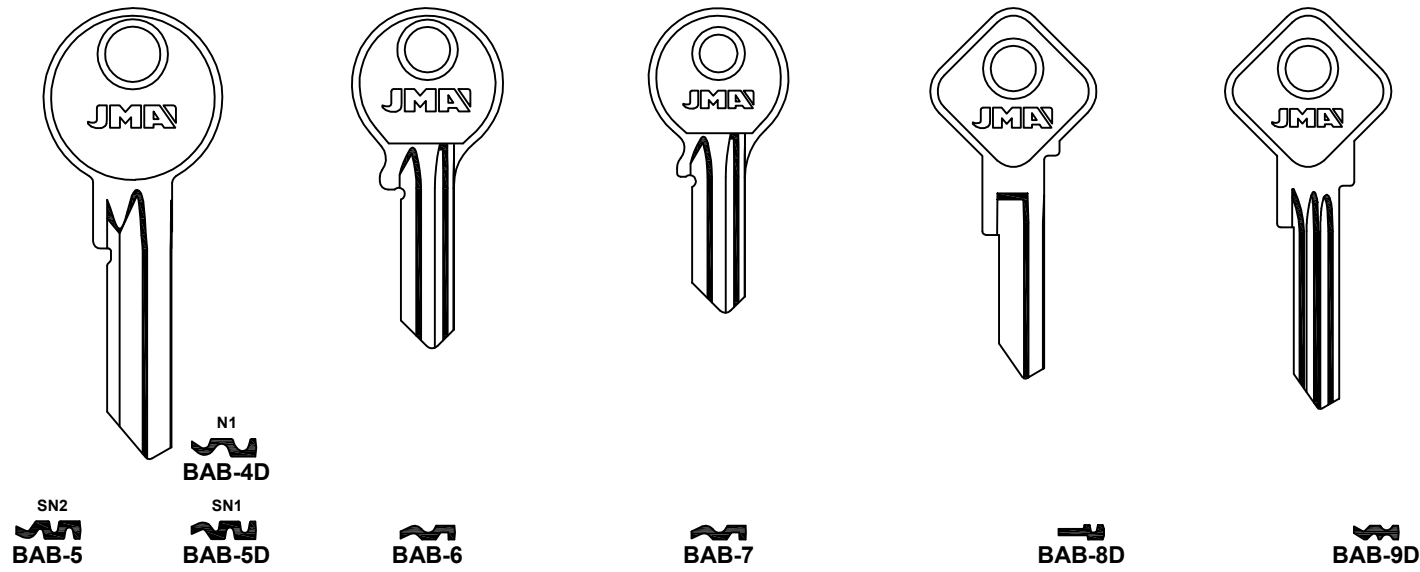

FOR: BASTA®

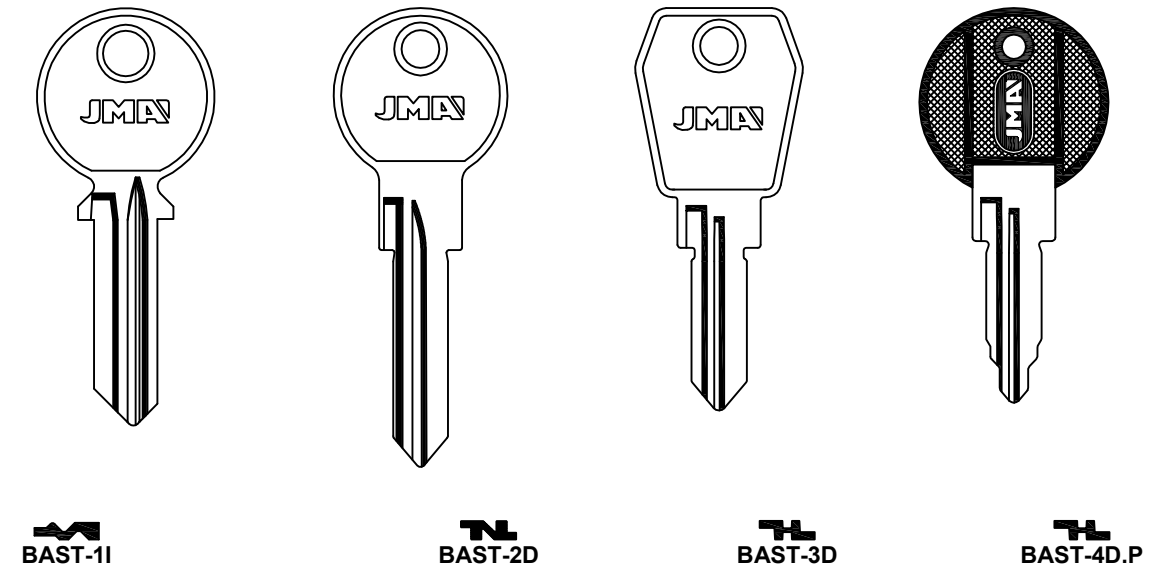

FOR: BATU®

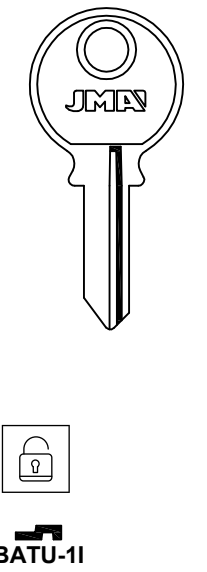

FOR: BAB®

FOR: BALTIKA®

FOR: BANHAM®

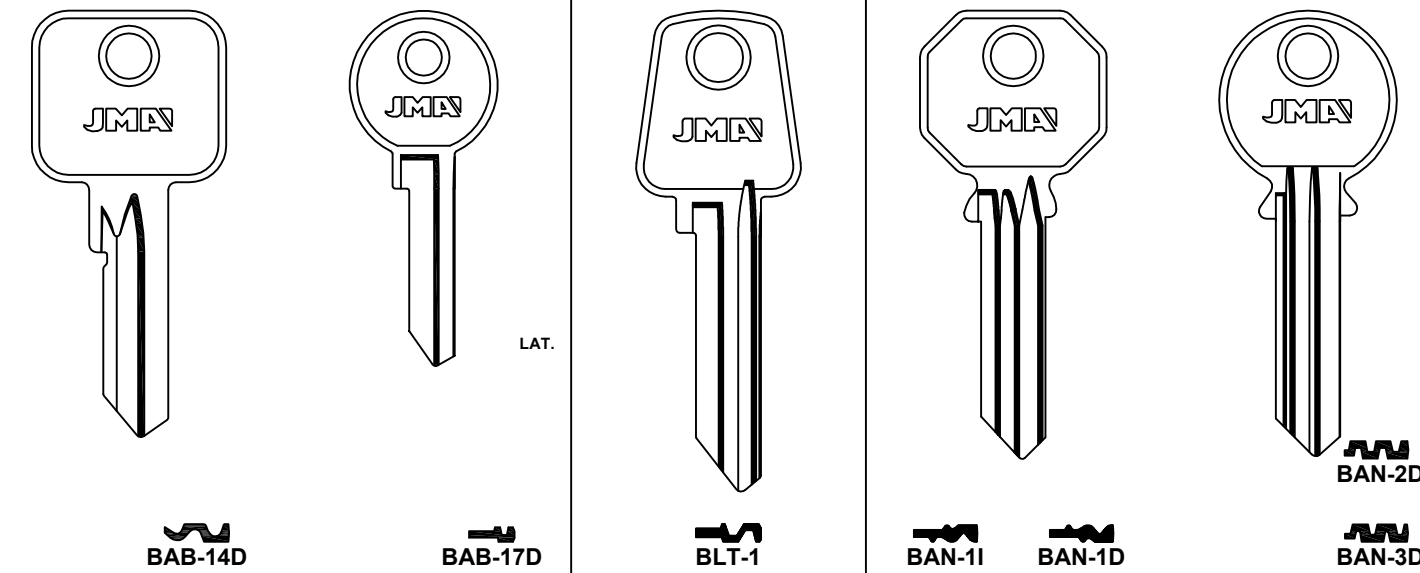

FOR: BEST®

FOR: BETA®

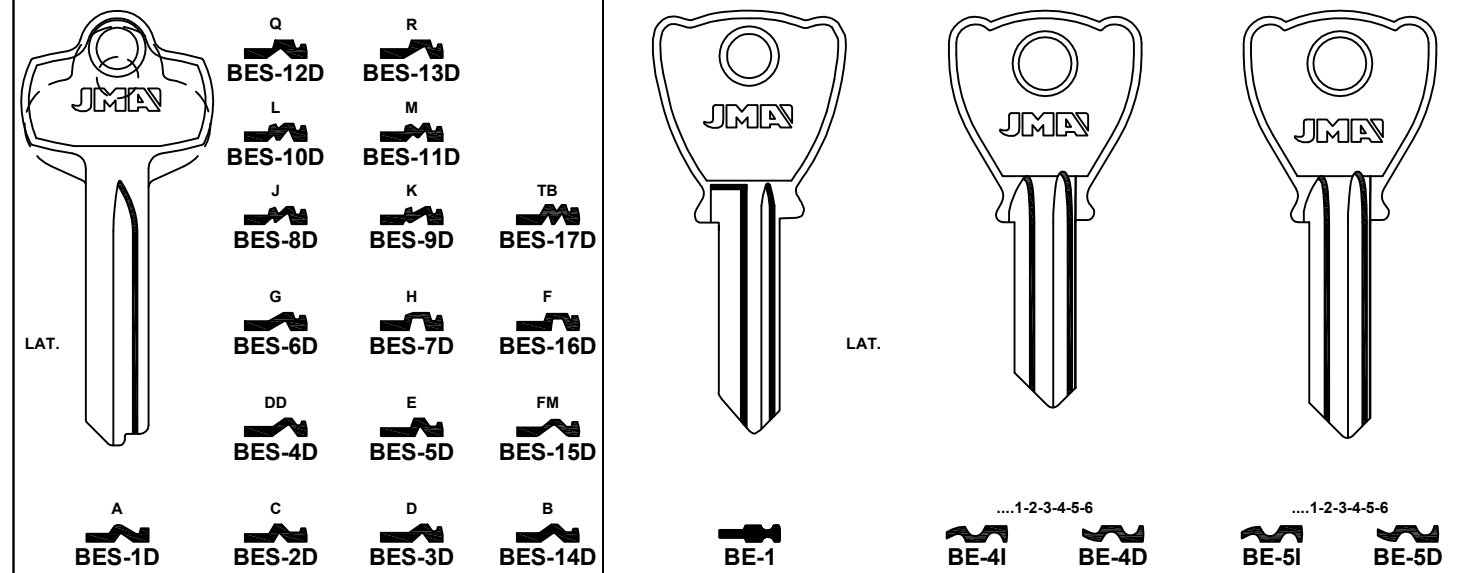

FOR: BAODELI®

FOR: BARCZ®

FOR: BASI®

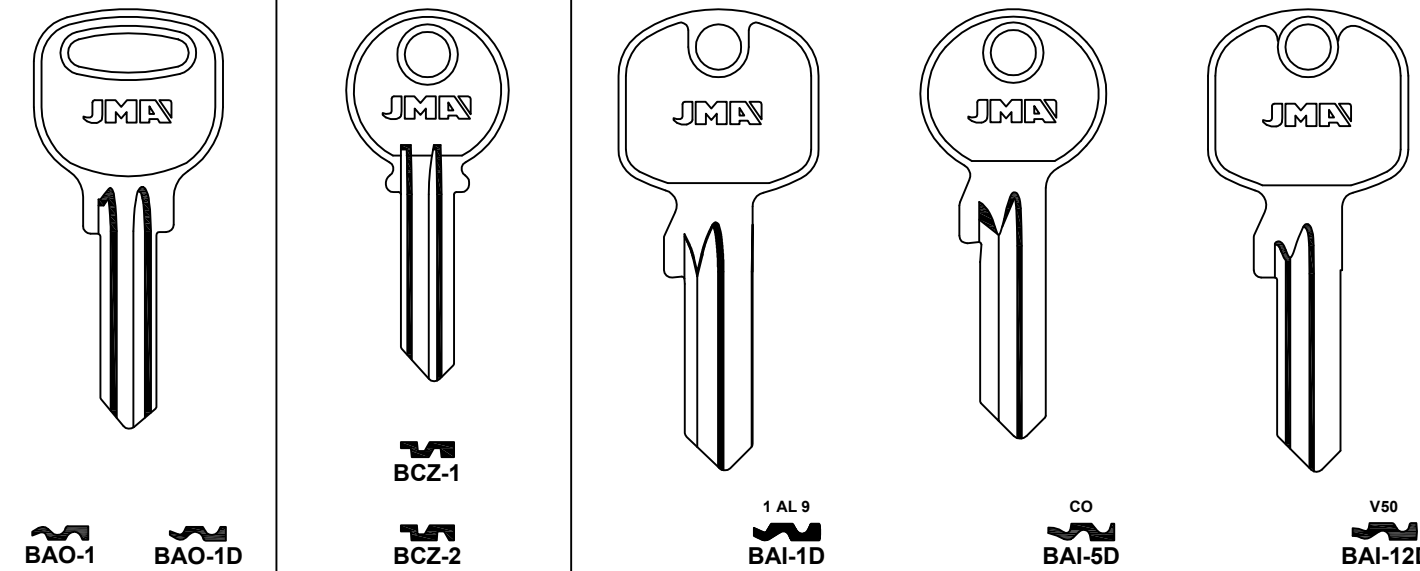

FOR: BIBERING®

FOR: BIELLE®

FOR: BIFFAR®

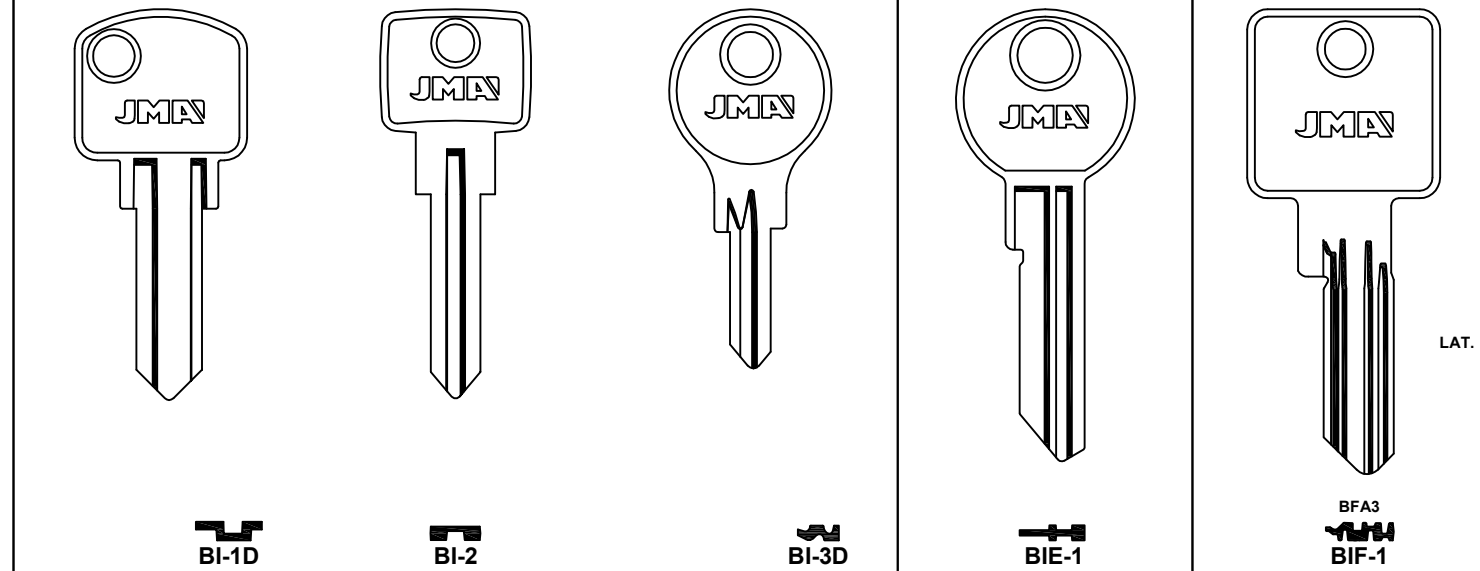

Concerning the marks and commercial denominations see legal warning.  
 Concerniente a las marcas y denominaciones comerciales ver aviso legal.  
 Marka eta izendapen komertzialiei dagokienez, ikus lege-oharra.  
 Concernant les marques et dénominations commerciales voir la note dans l'index.

**JMA**® Opening the future

**JMA**® Opening the future

Beziehen auf die marke und handelsname sehen sie die notiz im Impressum.  
 Relativamente às marcas e denominações comerciais, ver aviso legal.  
 Jeśli chodzi o znaki i nazwy handlowe, patrz Informacje prawne.

K01 / 17



FOR: BMB®			FOR: BODA®	FOR: BOMORO®
A...201-400	A...401-600			

FOR: BRICARD®					FOR: BRUMME®
FOR: ABUS®	FOR: ABUS®				FOR: FANA®

FOR: BOMORO®	FOR: BOULTON & P.®	FOR: BRABANTIA®	FOR: BRAS®	FOR: BRASIL®
FOR: LAPORTE®-PRESTA®	FOR: RST®		ALP.	

FOR: BSS®				
FOR: BANE SEKULIĆ®	FOR: BANE SEKULIĆ®	FOR: BANE SEKULIĆ®	FOR: BANE SEKULIĆ®	FOR: BANE SEKULIĆ®-GE GE®

FOR: BRICARD®				
FOR: STREMLER®				FOR: BLOCTOUT®-INLOC®

FOR: BSS®	FOR: BTV®	FOR: BUGA®
FOR: BANE SEKULIĆ®	FOR: SADV®	FOR: ARREGUI®

Concerning the marks and commercial denominations see legal warning.  
 Concerniente a las marcas y denominaciones comerciales ver aviso legal.  
 Marka eta izendapen komertzialiei dagokienez, ikus lege-oharra.  
 Concernant les marques et dénominations commerciales voir la note dans l'index.

**JMA** Opening the future

**JMA** Opening the future

Beziehen auf die marke und handelsname sehen sie die notiz im Impressum.  
 Relativamente às marcas e denominações comerciais, ver aviso legal.  
 Jeśli chodzi o znaki i nazwy handlowe, patrz Informacje prawne.

FOR: BULAT®

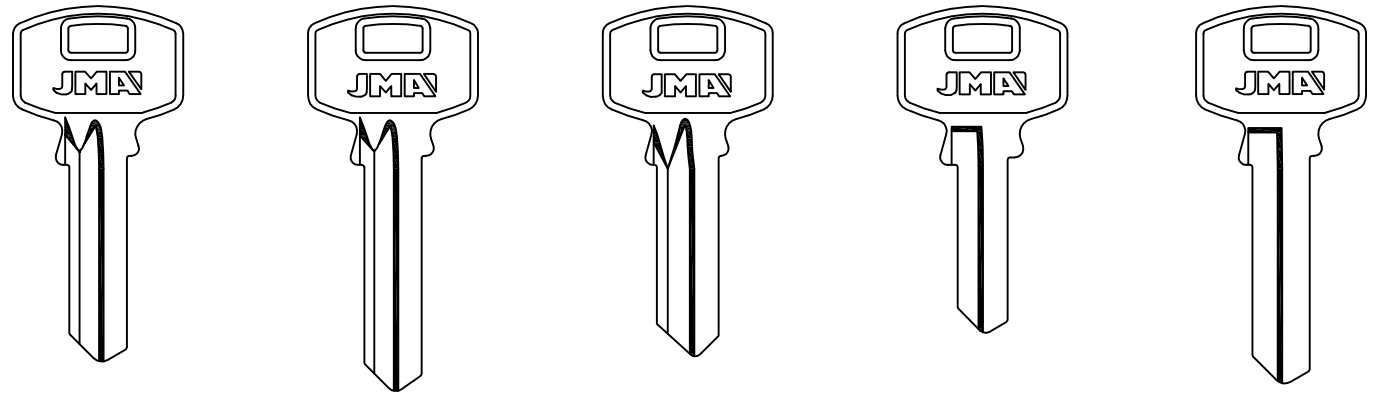

BUL-2D  
BUL-6D  
BUL-3D  
BUL-4D  
BUL-5D  
BUL-7D

FOR: BURG®

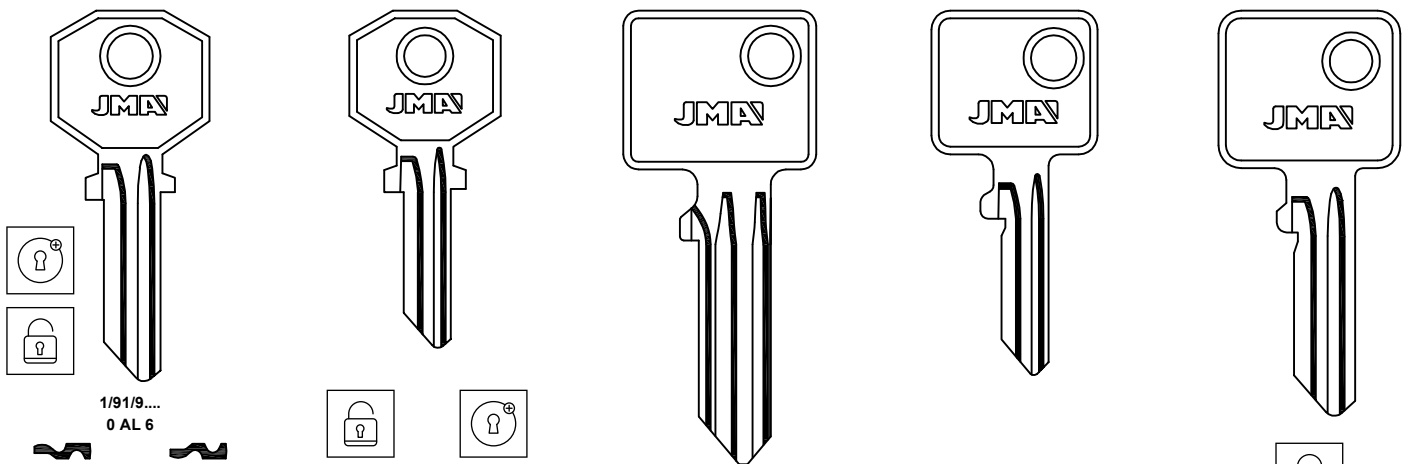

1/91/9...  
0 AL 6  
BUR-11  
BUR-1D  
BUR-27D  
1/91/9...  
0 AL 6  
BUR-21  
BUR-2D  
BUR-3  
BUR-3D  
BUR-4  
BUR-4D  
BUR-5  
BUR-5D  
FOR: MELSMETALL®  
FOR: MELSMETALL®

FOR: BURG®

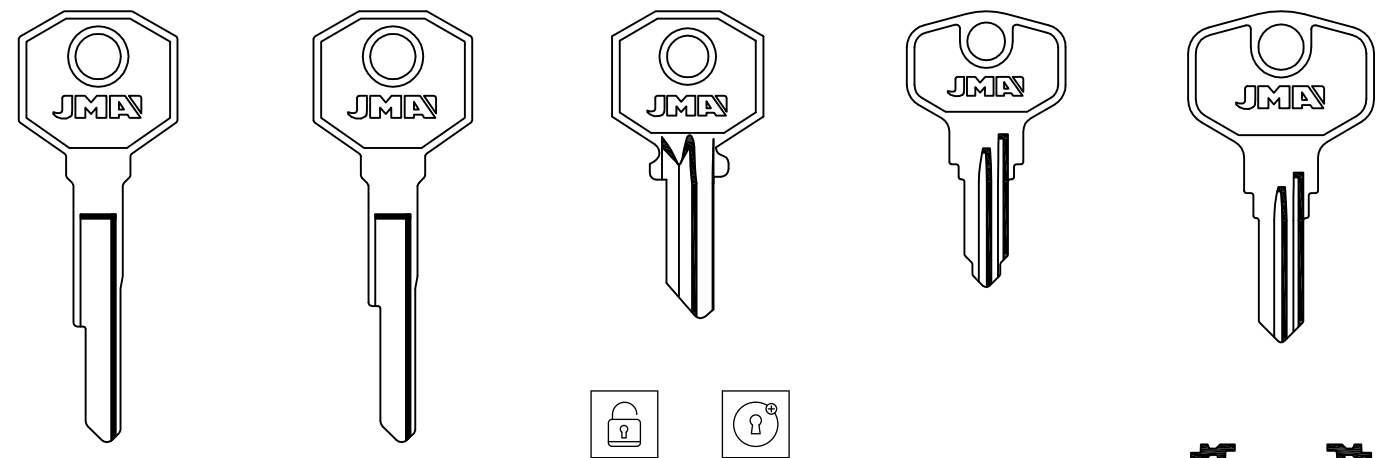

BUR-6  
BUR-7  
1/91/9...  
0 AL 6  
BUR-8D  
BUR-9  
BUR-9D  
BUR-38  
BUR-10  
BUR-10D  
FOR: ATL®-BURGWACHTER®-BUVA®-HEWY® FOR:  
FOR: DURABLE®-HOPPE®-RITTAL®-WSM® CIBOX®-HOPPE®-KIND®-ROTO®

FOR: BURG®

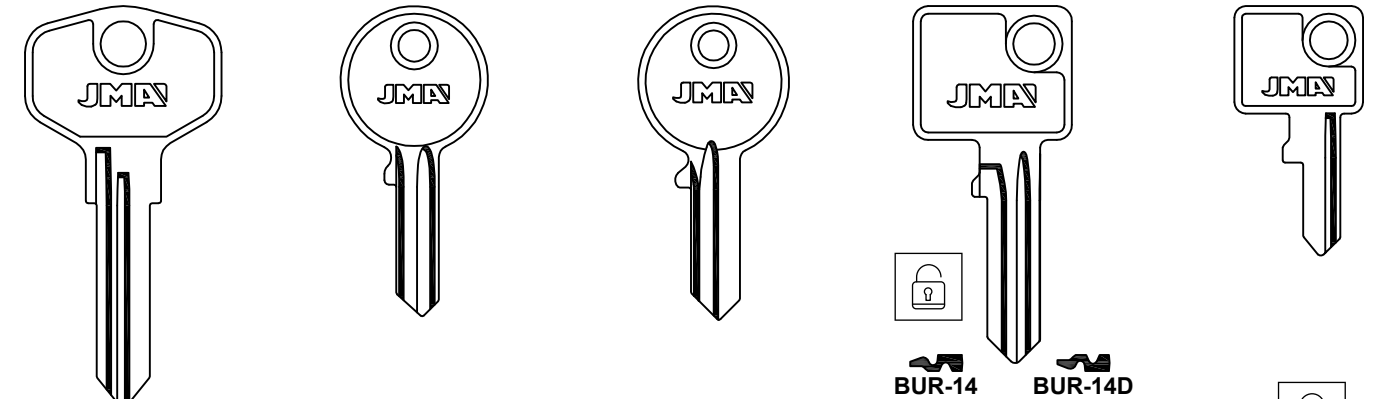

BUR-11D  
BUR-23D  
BUR-12  
BUR-13D  
BUR-14  
BUR-14D  
222 C40  
BUR-19D  
BUR-37D  
BUR-15  
FOR: ANKE®-BURGWACHTER® FOR: DESAL® FOR: ITEM®-RITTAL® FOR: BURG WACHTER®

FOR: BURG®

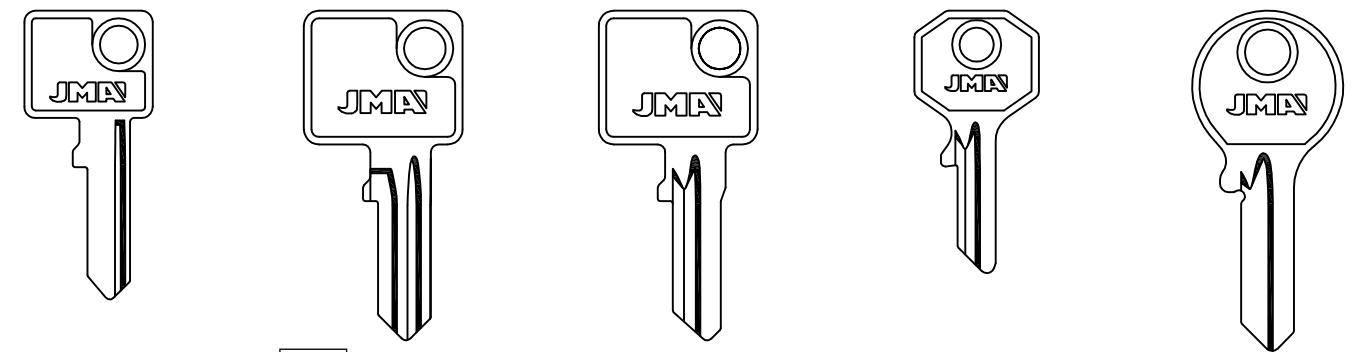

BUR-16  
BUR-17  
BUR-17D  
222 C30  
BUR-20D  
BUR-18D  
BUR-21D  
BUR-22D

FOR: BURG®

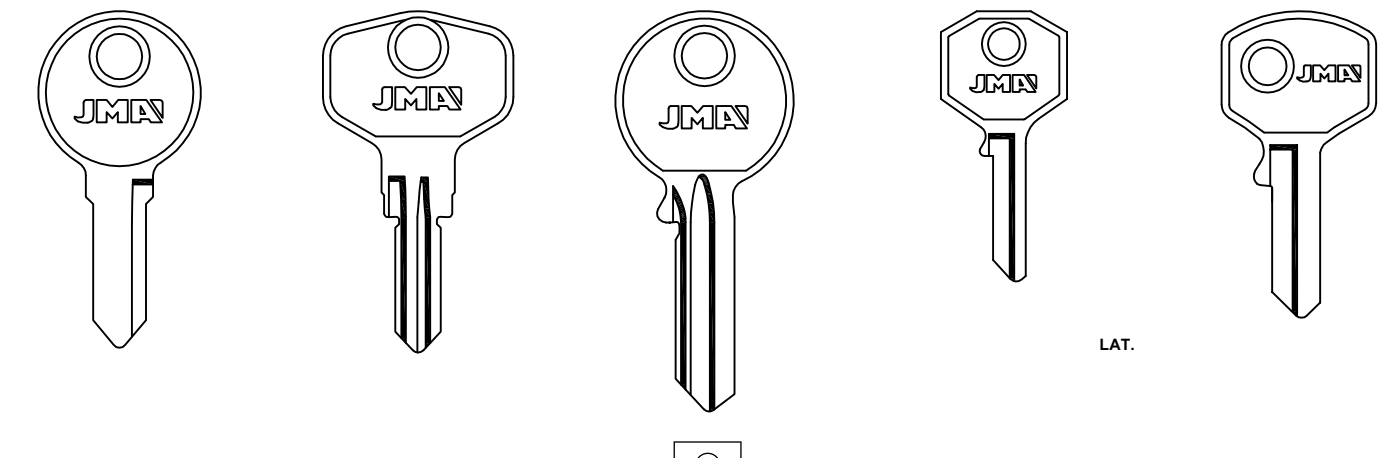

BUR-24  
BUR-24D  
BUR-25D  
BUR-26D  
BUR-28  
BUR-29  
BUR-29D  
LAT.

Concerning the marks and commercial denominations see legal warning.  
Concerniente a las marcas y denominaciones comerciales ver aviso legal.  
Marka eta izendapen komertzialiei dagokienez, ikus lege-oharra.  
Concernant les marques et dénominations commerciales voir la note dans l'index.



Beziehen auf die Marke und Handelsname sehen Sie die Notiz im Impressum.  
Relativamente às marcas e denominações comerciais, ver aviso legal.  
Jeśli chodzi o znaki i nazwy handlowe, patrz Informacje prawne.



**FOR: CAVERS®**

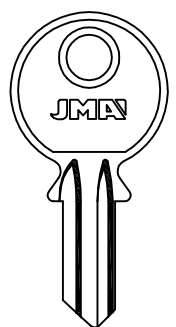

FOR: CITY®

CA-151

**FOR: CAYS®**

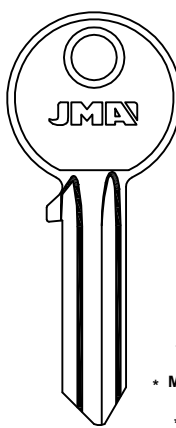

• ALU.  
• MTIC.(Y)  
• FSH.  
• WColor

CAY-1

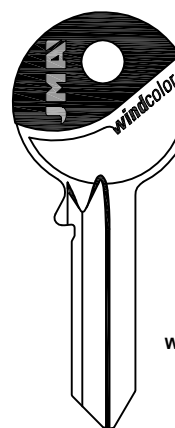

WColor

• CAY-1D

FOR: ILARGI®-SIB®

**FOR: CEMA®**

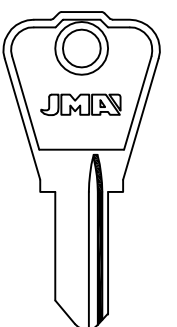

• LAT.

CMA-1

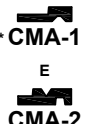

E

CMA-2

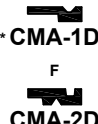

F

CMA-1D

CMA-2D

FOR: ELFIN®-LAMPA®

**FOR: CENTURY®**

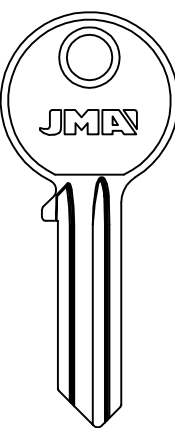

CENT-11



CENT-1D

FOR: ALLGOOD®

**FOR: CES®**

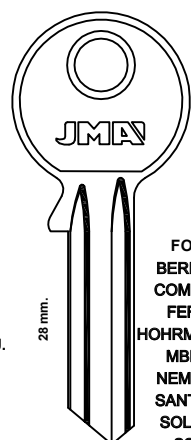

ALU. 28 mm.

FOR: BERRY®  
COMBA®  
FEFI®  
HOHRMANN®  
MBB®  
NEMEF®  
SANTIS®  
SOLID®  
SS®  
STUV®  
TRITON®

CE-5



CE-5D



CE-92



CE-92D



CE-93D



FOR: SOLID®

CE-61



CE-6D



CE-71

• MTIC.

\* CE-7D



CE-8D

FOR: NEMEF®



S

CE-136D/1

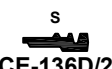

S

CE-136D/2



S

CE-136D/4



S

CE-136D/5

**FOR: CENTURY®**

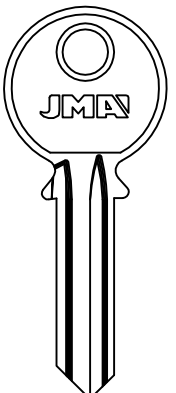

CENT-21



CENT-2D

FOR: ALLGOOD®

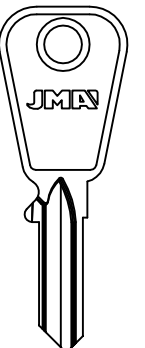

WR  
1 AL 4

CENT-3D

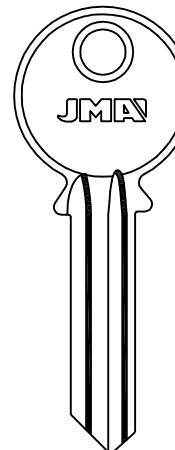

CENT-4

**FOR: CERRAMARC®**

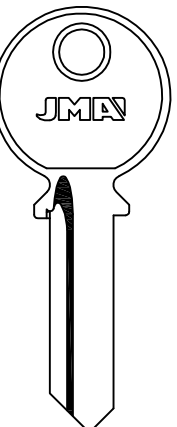

CER-1

**FOR: CES®**

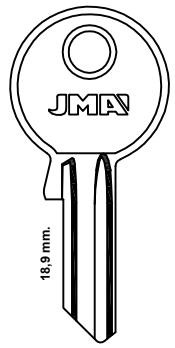

18,9 mm.

CE-11



CE-1D

FOR: STUV®

**FOR: CES®**

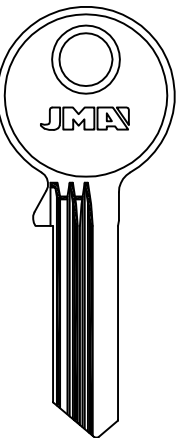

X23

CE-9D



X24

CE-10D



X25

CE-11D



X26

CE-12D



X27

CE-13D



X28

CE-14D



X29

CE-15D



X30

CE-16D



X31

CE-17D



X32

CE-18D



X33

CE-19D



X34

CE-20D



X35

CE-21D



X36

CE-22D



X37

CE-23D



X38

CE-24D



X39

CE-25D



X40

CE-26D



X41

CE-27D



X42

CE-28D



W23

CE-29D



W24

CE-30D



W25

CE-31D



W26

CE-32D



W27

CE-33D



W28

CE-34D



W29

CE-35D



W30

CE-36D



W31

CE-37D



W32

CE-38D



W33

CE-39D



W34

CE-40D



W35

CE-41D



W36

CE-42D



W37

CE-43D



W38

CE-44D



W39

CE-45D



W40

CE-46D



W41

CE-47D



W42

CE-48D



CE-49



CE-49D

FOR: SOLID®

**FOR: CES®**

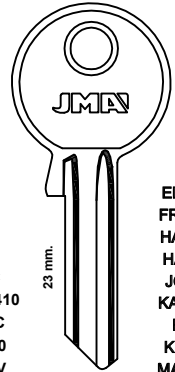

1C  
401-410  
10C  
1-10  
HLV  
911-950  
FOR:  
BODA®  
ELZETT®  
FRECOV®  
KNAPP®

23 mm.

CE-21



CE-2D



FOR:  
ELZETT®  
FRECOV®  
HAFELE®  
HANNO®  
JOSTA®  
KARDEX®  
KIND®  
KNAPP®  
MAUSER®  
NEMEF®

CE-108



CE-101D



CE-100D



CE-99D

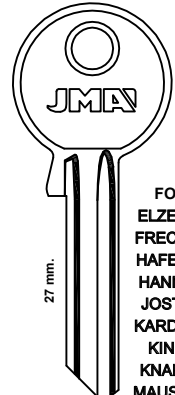

27 mm.

CE-31



CE-3D



FOR:  
BODA®  
ELZETT®  
FRECOV®  
KNAPP®  
NEMEF®  
OJMAR®  
VOKO®  
WASO®  
WECO®

CE-3D



CE-4D

FOR: CASMA®-SPEEDAL®

**FOR: CES®**

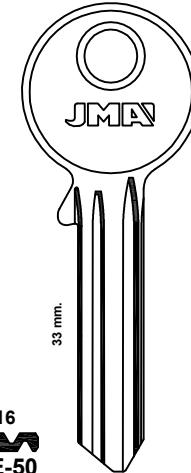

16

CE-50



1Z...1-100000

CE-51



CE-51D

• LAT.



26

• CE-55



27

• CE-56



28

• CE-57



15

• CE-77



17

• CE-78



18

• CE-79



25

• CE-80



35

• CE-81



36

• CE-82



37

• CE-83



38

• CE-84



45

• CE-85



46

• CE-86



47

• CE-87



48

• CE-88



CE-91



CE-52



CE-53D

FOR: HAFELE®

Concerning the marks and commercial denominations see legal warning.  
Concarniente a las marcas y denominaciones comerciales ver aviso legal.  
Marka eta izendapen komertzialiei dagokienez, ikus lege-oharra.  
Concernant les marques et denominations commerciales voir la note dans l'index.



FOR: CES®

31,5 mm.

LAT.

A5 CE-61, A4 CE-60, A3 CE-59, A2 CE-58, A1 CE-54

B5 CE-66, B4 CE-65, B3 CE-64, B2 CE-63, B1 CE-62

C5 CE-71, C4 CE-70, C3 CE-69, C2 CE-68, C1 CE-67

D5 CE-76, D4 CE-75, D3 CE-74, D2 CE-73, D1 CE-72

K CE-90D

CE-89, CE-89D, CE-94, CE-133

FOR: BODA®

FOR: CES®

LAT.

CE-96, CE-97, CE-98D, CE-102, CE-103, CE-104D, CE-105, CE-106, CE-107, CE-111D, CE-117D

FOR: CASMA®-SPEEDAL®, FOR: NEMEF®

FOR: CES®

LAT.

CE-109D, CE-130, CE-131D, CE-132/15, CE-132/16, CE-132/17, CE-132/18, CE-132/25, CE-132/26, CE-132/27, CE-132/35, CE-132/36, CE-132/37, CE-132/38, CE-132/45, CE-132/46

WS 401-410

FOR: CES®

CE-134

FOR: CHAVO®

CHA-2, CHA-2D

FOR: CHELIABINSK®

CHTZ-1

FOR: CHEYLOCK®

CHEK-1

FOR: CHICAGO®

CHI-1, CHI-2, CHI-3, CHI-4, CHI-5

FOR: CHICAGO®

CHI-6, CHI-10D

FOR: ILLINOIS ODA®, FOR: STEELCASE®

FOR: CHUBB®

CHI-7D, CHI-8D, CHI-9D, CHI-10D, CHU-1D, CHU-10

FOR: AVA®-CHUBB®

FOR: CIEF®

CF-11, CF-1D

FOR: ESAFE®-FEB®

FOR: CIFIAL®

CIF-1D, CIF-2D, CIF-3, CIF-3D, CIF-4

FOR: LEFEBURE®, FOR: EFER®

Concerning the marks and commercial denominations see legal warning.  
 Concerniente a las marcas y denominaciones comerciales ver aviso legal.  
 Marka eta izendapen komertzialiei dagokienez, ikus lege-oharra.  
 Concernant les marques et dénominations commerciales voir la note dans l'index.

Beziehen auf die marke und handelsname sehen sie die notiz im Impressum.  
 Relativamente às marcas e denominações comerciais, ver aviso legal.  
 Jeśli chodzi o znaki i nazwy handlowe, patrz Informacje prawne.



FOR: CILA-GENTILI®

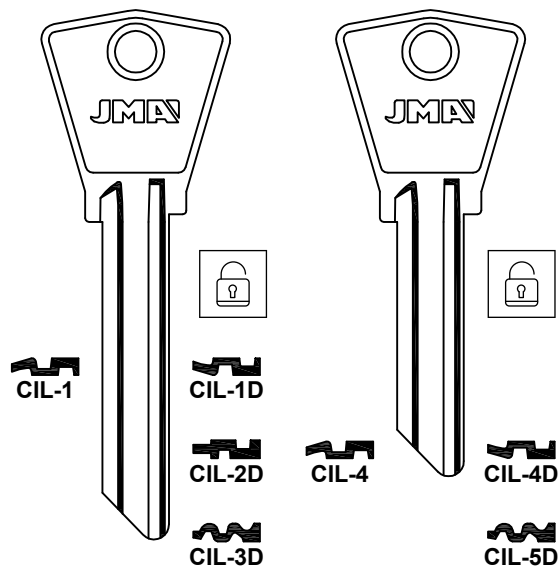

FOR: CINA®

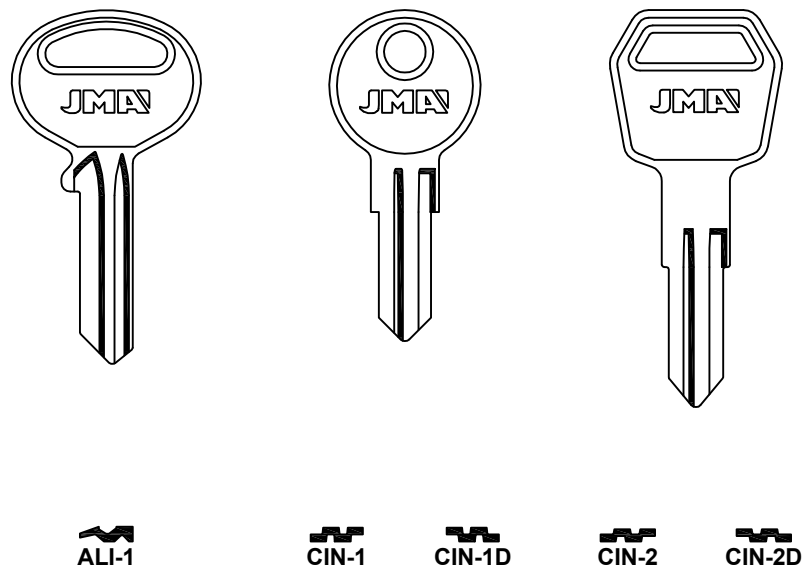

FOR: CISA®

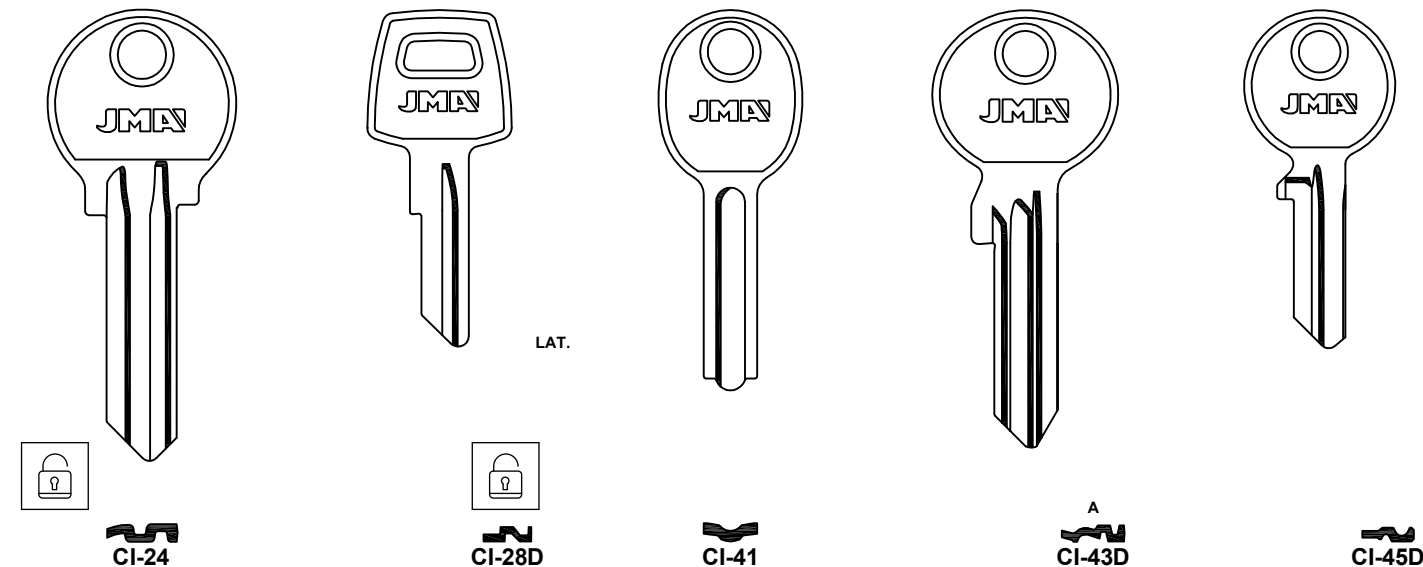

FOR: CISA®

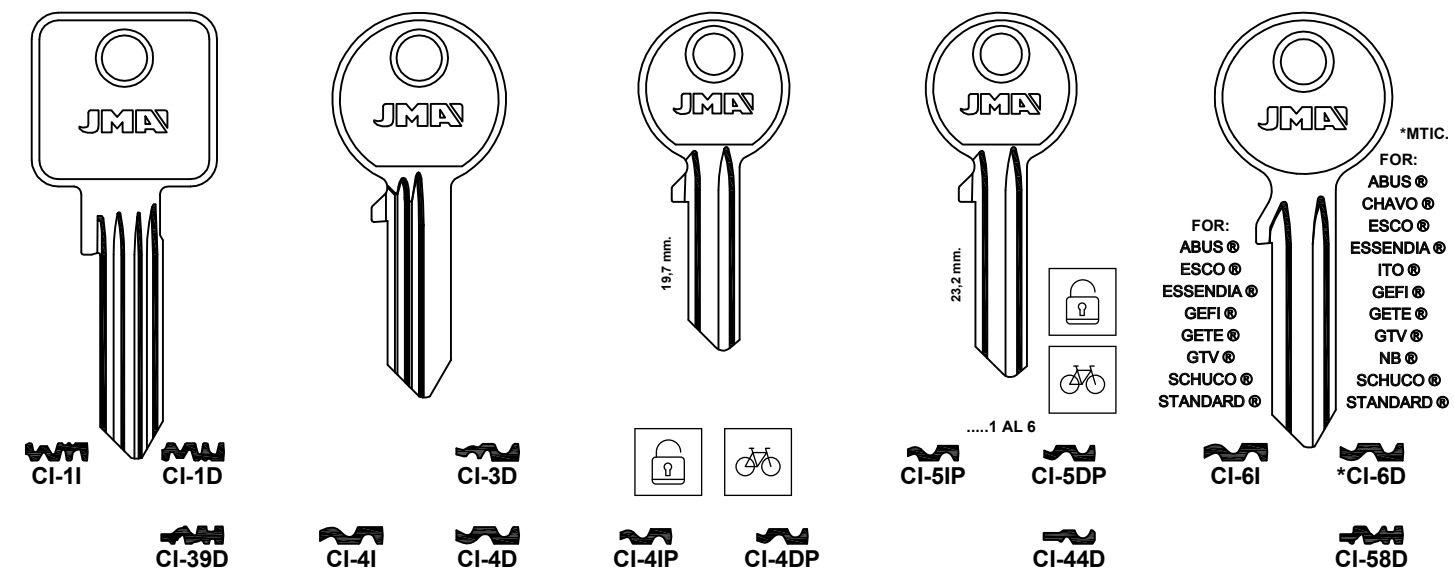

FOR: CISA®

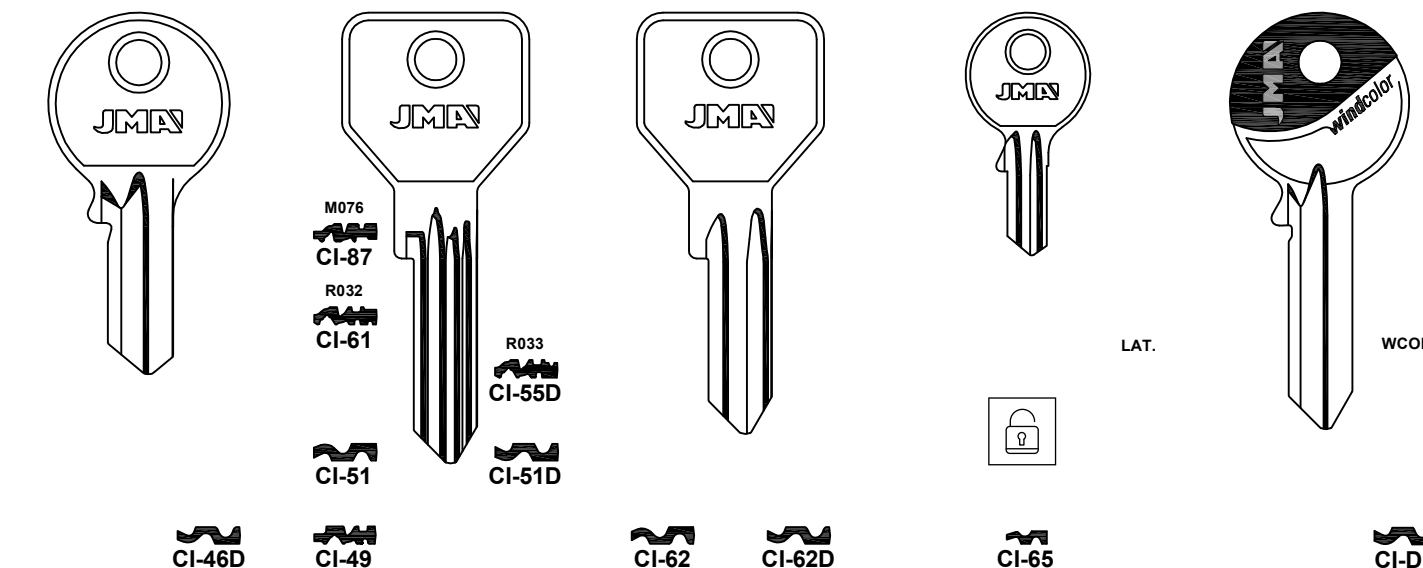

FOR: CISA®

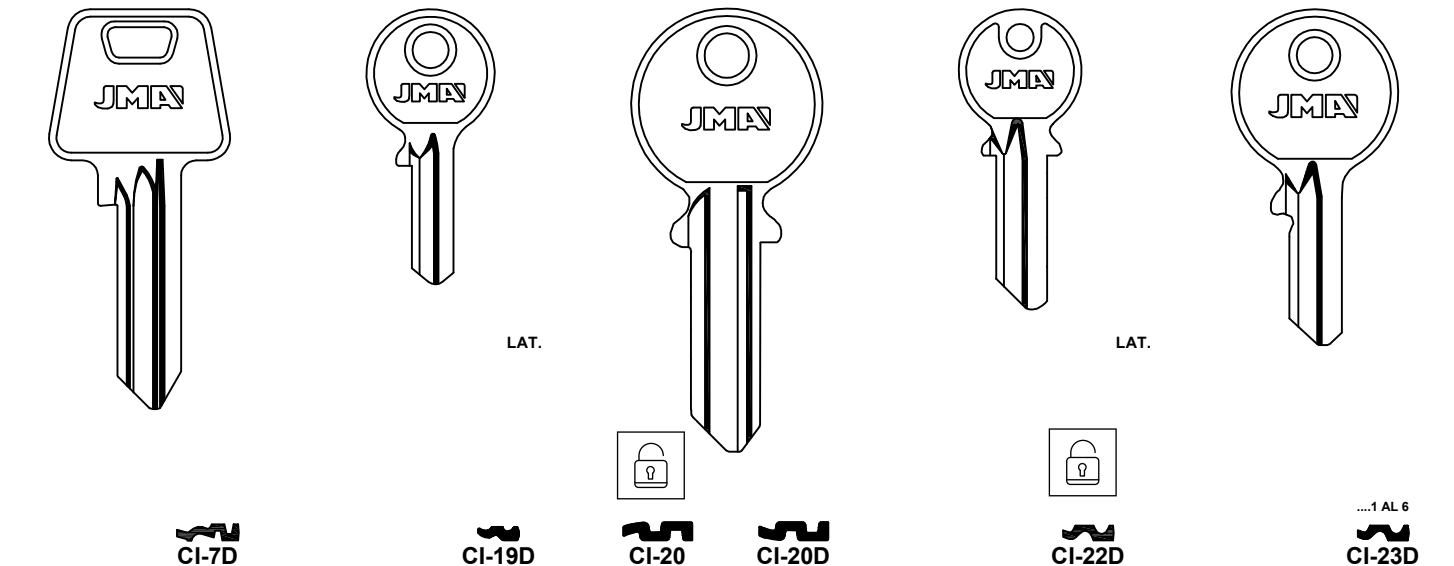

FOR: CISA®

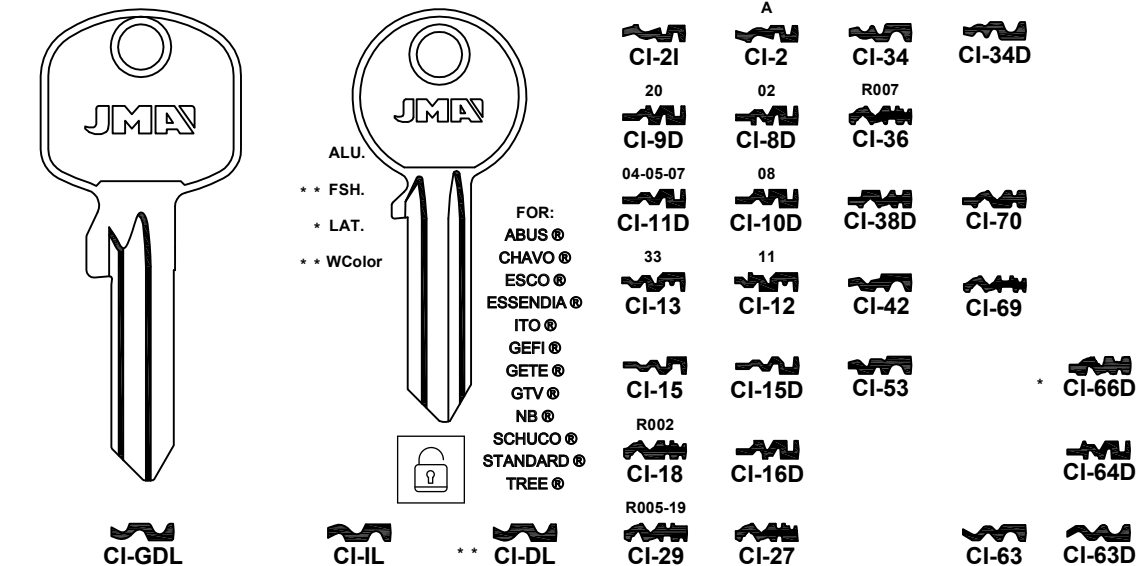

FOR: CLARK FORK L.®

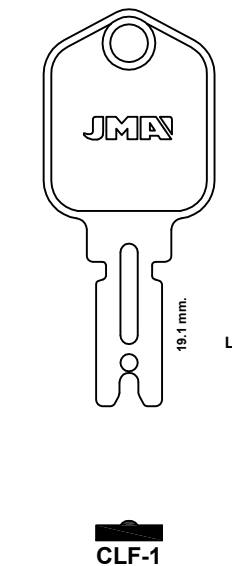

Concerning the marks and commercial denominations see legal warning.  
 Concerniente a las marcas y denominaciones comerciales ver aviso legal.  
 Marka eta izendapen komertzialiei dagokienez, ikus lege-oharra.  
 Concernant les marques et denominations commerciales voir la note dans l'index.

**JMA®** Opening the future

**JMA®** Opening the future

Beziehen auf die marke und handelsname sehen sie die notiz im Impressum.  
 Relativamente às marcas e denominações comerciais, ver aviso legal.  
 Jeśli chodzi o znaki i nazwy handlowe, patrz Informacje prawne.

**K01 / 31**

**FOR: CLASSIC®** **FOR: CLAUSOR®** **FOR: CLEMSA®**

ALU. PLAS. PLAS.

CLS-1D CL-11 MG-6I MG-6S MG-6D MG-9

FOR: BRABANTIA®

**FOR: CORBIN®**

28 mm. 30,7 mm.

COR-7 COR-8 COR-9 COR-10 COR-61 COR-11 COR-11D COR-12 COR-13 COR-13D COR-72

1 AL 9  
0 AL 8  
2 AL 8

FOR: MASTER® FOR: EUROPARTNER® -FUCHS®

**FOR: COHIKO®** **FOR: COM®**

COH-1 COH-2 COH-2D COH-3 COH-4 COM-1D

FOR: SONICO®

**FOR: CORBIN®**

027 COR-64 029 COR-65 038 COR-66 \* LAT. COR-67 COR-68 \* COR-71

11,5 mm. 1 AL 6

COR-15D COR-73 COR-74 COR-17D COR-20 COR-20D COR-20/25 COR-23D

FOR: TESIO®

**FOR: CORBIN®**

FOR: ALUNORM® CRC® -CAMBOA® DOM® ESCO® EURONORM® HEGO® HESTE® ISSERSTEDT® KAWE® LITTO® \* COR-48 MERMIER® MUKRA® NEMEF® NOVOFERM® COR-49 BWS STREMLER® SUL® THONE® VERSCO® ZECE® CORNI®

COR-18D COR-19D COR-21D COR-22D COR-36D COR-1GD COR-1D COR-21 COR-2D COR-3 COR-3D COR-79 COR-76D COR-1GD COR-1D COR-16D

FOR: ESCO® -KAWE® -LITTO® -NEMEF®

**FOR: CORBIN®**

23 mm. 21 mm.

...1 AL 7  
...2 AL 7

COR-24 COR-24D COR-25I COR-25 COR-26 COR-27D COR-28

FOR: CHANGE-O-MATIC® -BOBRICK® FOR: SKILMANN® FOR: ESCO® -EURONORM® -KAWE® -MUKRA®

Concerning the marks and commercial denominations see legal warning.  
 Concerniente a las marcas y denominaciones comerciales ver aviso legal.  
 Marka eta izendapen komertzialiei dagokienez, ikus lege-oharra.  
 Concernant les marques et denominations commerciales voir la note dans l'index.

Beziehen auf die marke und handelsname sehen sie die notiz im Impressum.  
 Relativamente às marcas e denominações comerciais, ver aviso legal.  
 Jeśli chodzi o znaki i nazwy handlowe, patrz Informacje prawne.

FOR: CORBIN®

17,5 mm.

1 AL 9  
1 AL 7  
2 AL 7

COR-29D COR-30 COR-31 COR-33 COR-34

FOR: CCL®

FOR: CORBIN®

ACE.  
LAT.

21 mm.

26 mm.

1 AL 9  
1 AL 7  
2 AL 7

2 AL 9  
1 AL 9

COR-35 COR-40 COR-50/60 COR-62 COR-70 COR-70D

FOR: LANE® FOR: OAL® FOR: MERMIER®-OAL®

FOR: CORBIN®

7 PIN

COR-78 COR-114 COR-115D COR-153 COR-223

GRM .....1234567

FOR: BLACK & DECKER®

FOR: CORBIN®

LAT. LAT.

COR-231 COR-232D

FOR: BWS®

FOR: CORONA®

COL. M

CO-1D CO-M

FOR: BAB®-BURG®-DOCO®-GEBRO®-IKON® FOR: IKON®

FOR: COTICO®

COT-1D

FOR: CRAZY LOCKS®

CLK-1

FOR: CUBELLS®

CUB-1

FOR: CVL®

LAT. ALU. ALU.

CVL-11 CVL-1D CVL-21 CVL-2D CVL-31 CVL-3D

FOR: SERRALLER® FOR: UCER®

FOR: CVL®

• FSH.  
• ALU.  
• WColor

WColor

CVL-4 CVL-6

• CVL-5I • CVL-5D CVL-5I CVL-5D CVL-8D

FOR: AUMON®-CAYS®-CAZORLA®-EURO® FOR: AUMON®-CAYS®-CAZORLA®-EURO®  
FERMOD®-JJ®-PP®-QCM® FOR: FERMOD®-JJ®-PP®-QCM®

FOR: DAD®

DAD-11 DAD-1D DAD-21 DAD-2D DAD-3D DAD-4D DAD-5D DAD-6D

FOR: DECAYEUX® FOR: ARFE®-DECAYEUX®

FOR: DAF®		FOR: DEFA®		FOR: DEKABA®	
DAF-1	DAF-1D	DEF-1D	DEF-1D	DEK-2	DEK-6D
				DEK-7D	DEK-14D
				FOR: MAUER®	FOR: MAUER®
					DEK-9D

FOR: DEKABA®		FOR: DELAPORTE®		FOR: DELMET®	
DEK-10	DEK-13	2501-2550	DLP-1	DLM-1D	DLM-1D
	FOR: MAUER®	FOR: DIRAK®-EMKA®	DLP-2		
					FOR: M&D®

FOR: DEXTER®		FOR: DIAMOND®			
DX-5	DX-5D	DIA-1	DIA-2	DIA-3	DIA-3
0 AL 7 T 0 AL 9 0 AL 9	0 AL 7 0 AL 9				

FOR: DIEBOLD®	FOR: DIMITROVGRAD®	FOR: DINBOX®	FOR: DOM®	
DIE-1	DM-1	DBX-1D	DOM-11	DOM-1D
			FOR: BTV® DAD® ESAFE® FECOR® HAEFELE® HEKNA® HUWIL® MECALUX® METEOR® MLM® RENZ® RUKA® SCHLEGEL® STS®	FOR: BTV® DAD® ESAFE® FECOR® HAEFELE® HEKNA® HUWIL® MECALUX® METEOR® MLM® RENZ® RUKA® SCHLEGEL® STS®
			2D 001-222 5A 0001-2600 9A 0001-5200 1D 601-654	2D 001-222 5A 0001-2600 9A 0001-5200 1D 601-654

FOR: DOM®				
DOM-21D	DOM-2D	DOM-44D	DOM-45	DOM-46D
FOR: MOREAUX®-STUV®-CORBIN®	FOR: PLURA® DOM-75	FOR: LISTA® DOM-3D	FOR: LISTA® DOM-4D	FOR: LISTA® DOM-8D
		FOR: CHRIST®	FOR: STEIGA®-STUV®-VIKI®	FOR: BARRO®-IDEAL®-TM®

FOR: DOM®				
DOM-71	DOM-7D	DOM-9	DOM-9D	DOM-10D
FOR: HOHRMANN®	FOR: NOBO®	FOR: NOBO®	FOR: NOBO®	FOR: NOBO®

Concerning the marks and commercial denominations see legal warning.  
 Concerniente a las marcas y denominaciones comerciales ver aviso legal.  
 Marka eta izendapen komertzialiei dagokienez, ikus lege-oharra.  
 Concernant les marques et dénominations commerciales voir la note dans l'index.

**JMA** Opening the future

**JMA** Opening the future

Beziehen auf die Marke und Handelsname sehen Sie die Notiz im Impressum.  
 Relativamente às marcas e denominações comerciais, ver aviso legal.  
 Jeśli chodzi o znaki i nazwy handlowe, patrz Informacje prawne.

FOR: DOM®

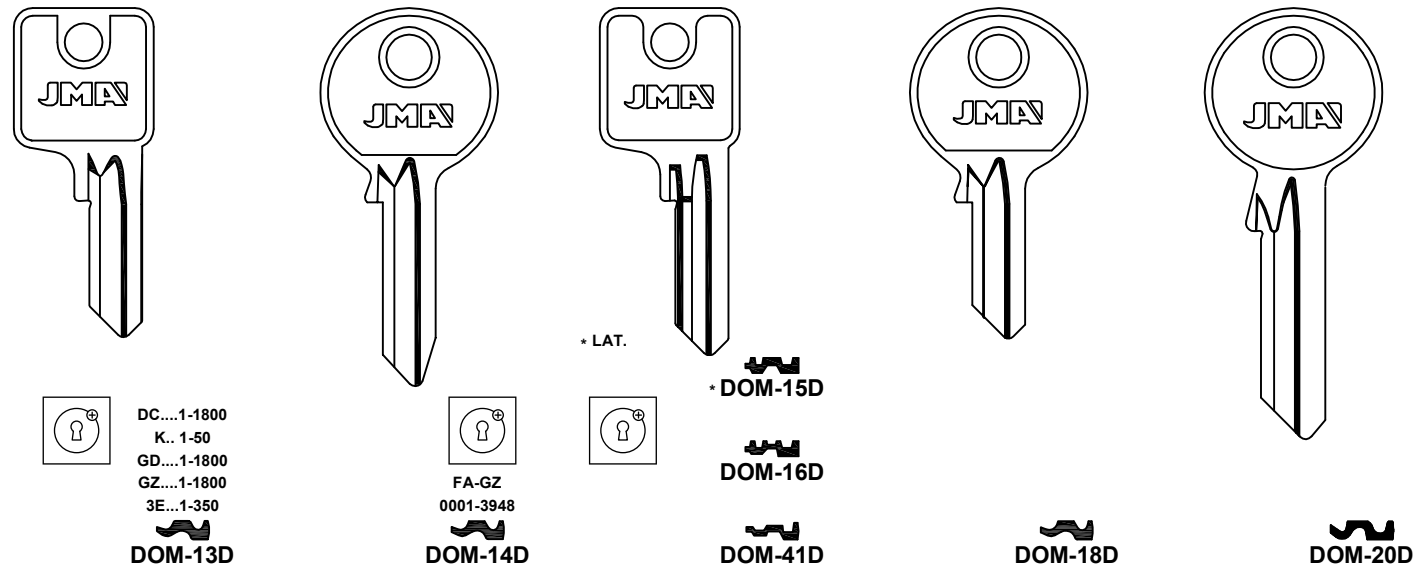

FOR: DOM®

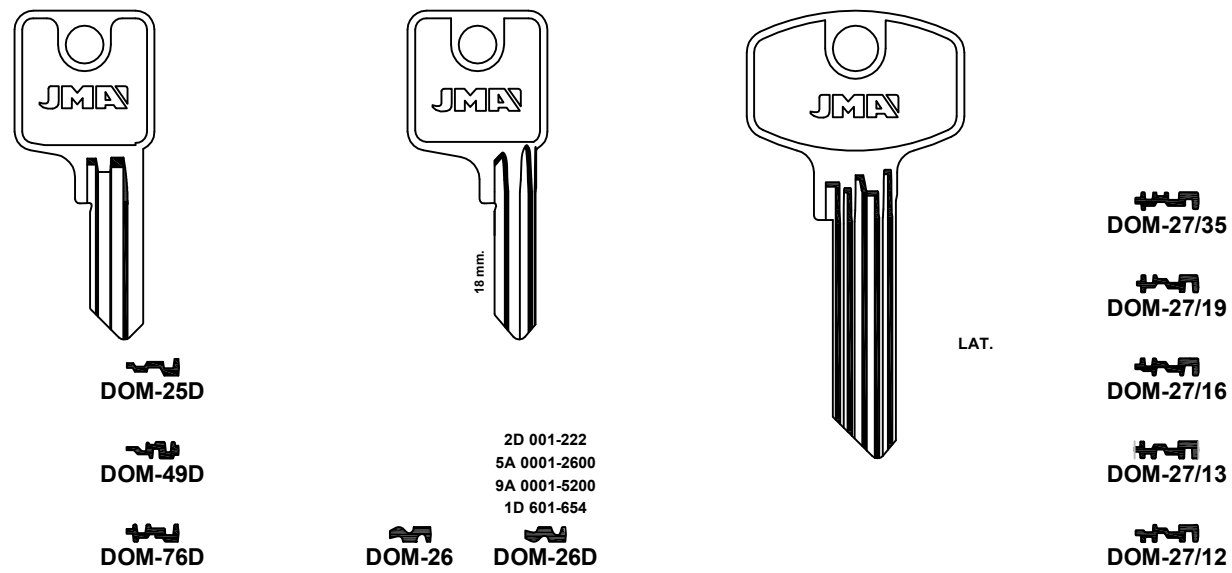

FOR: DOM®



FOR: DOM®

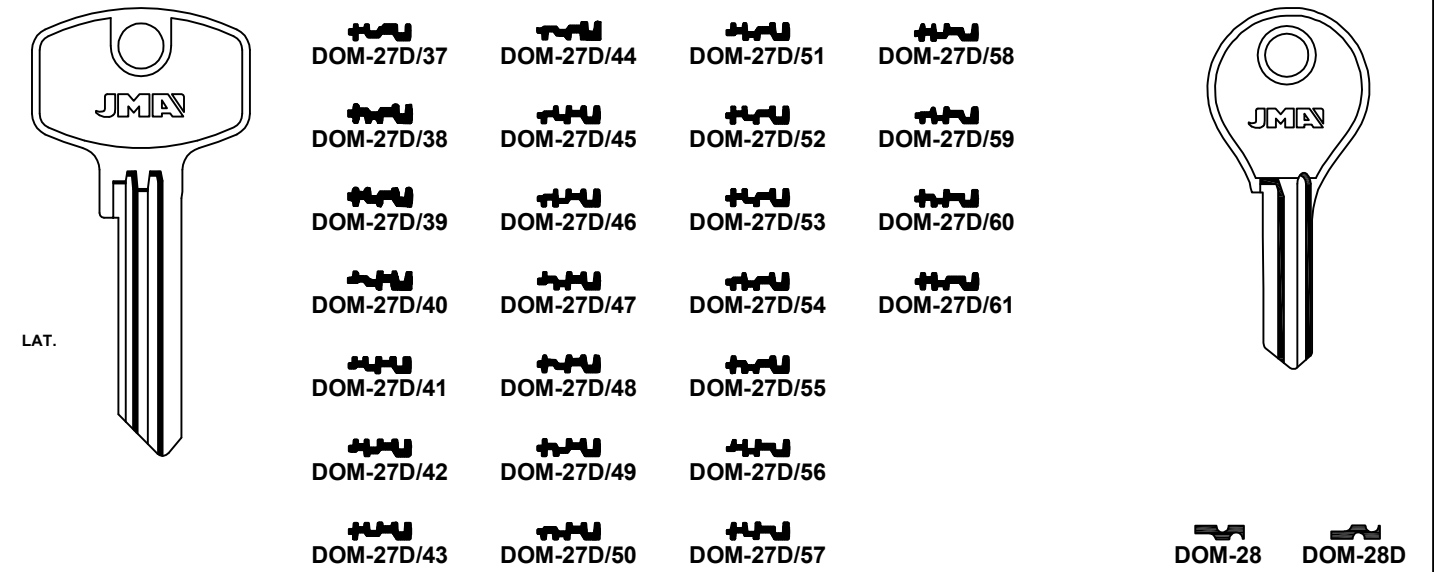

FOR: DOM®

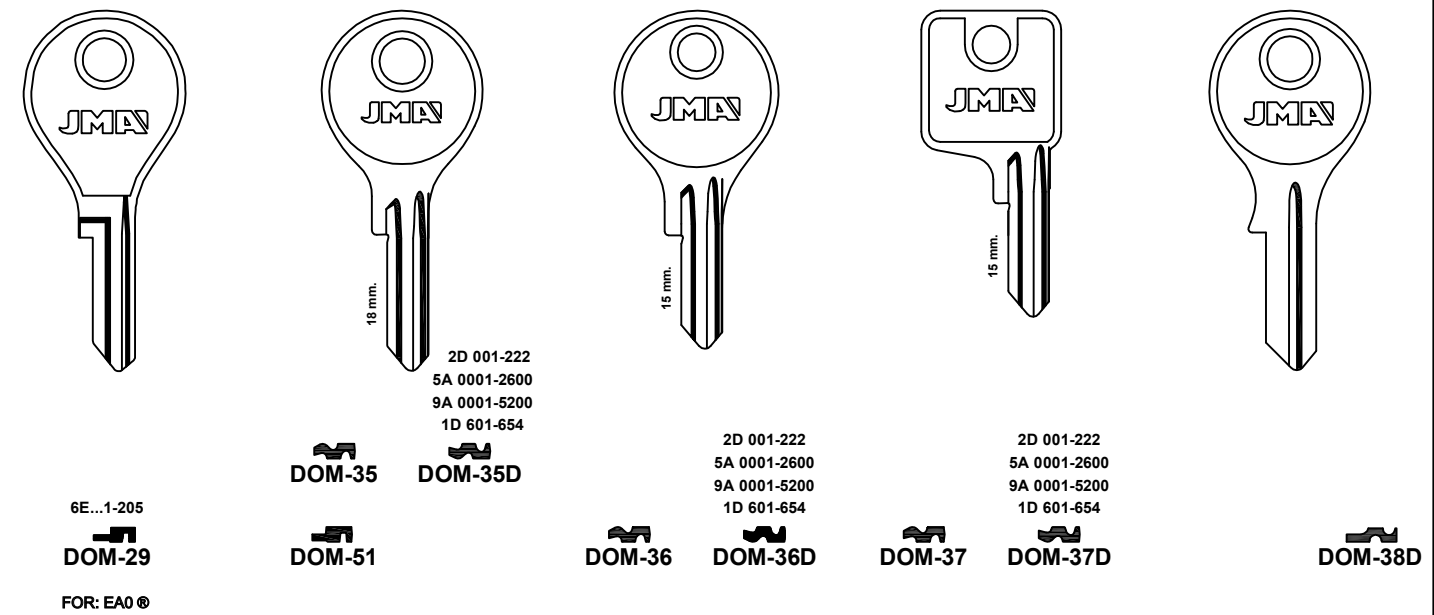

FOR: DOM®

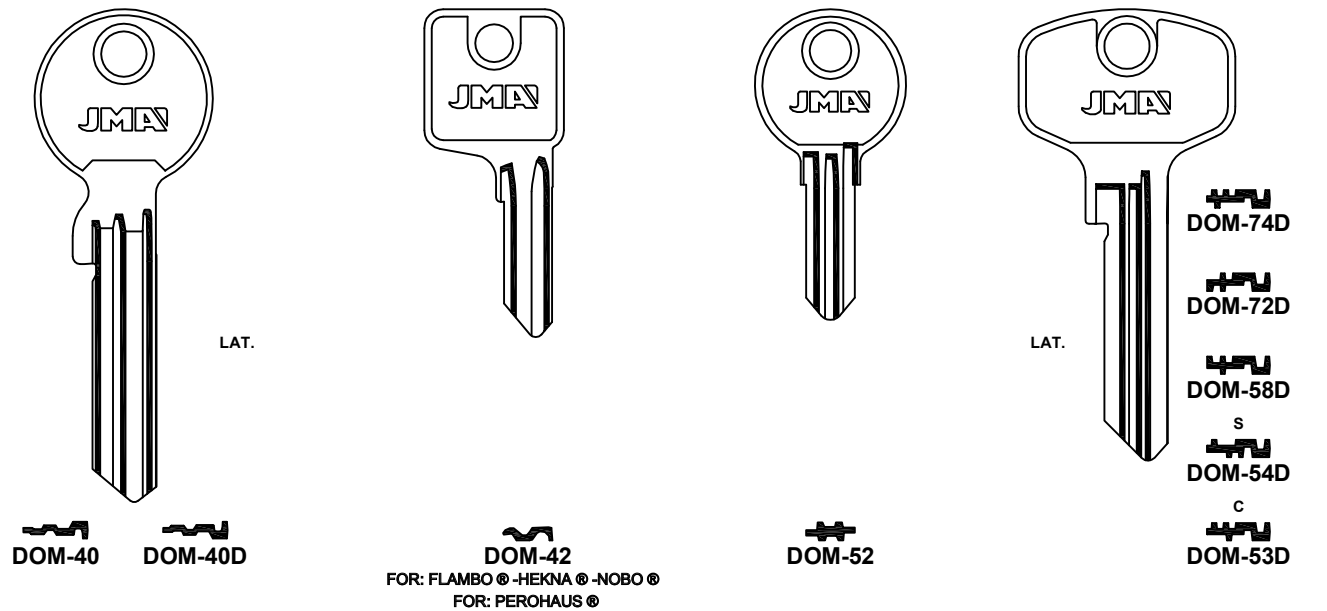

Concerning the marks and commercial denominations see legal warning.  
Concerniente a las marcas y denominaciones comerciales ver aviso legal.  
Marka eta izendapen komertzialiei dagokienez, ikus lege-oharra.  
Concernant les marques et dénominations commerciales voir la note dans l'index.











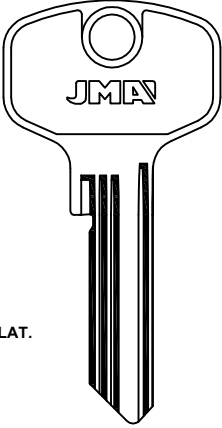

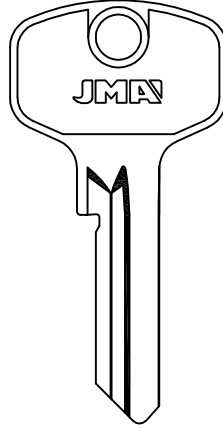

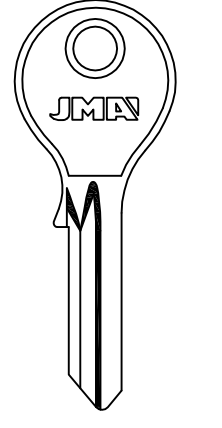
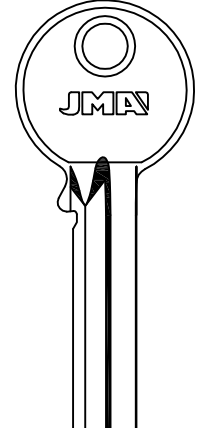

**JMA**® Opening the future





**JMA**® Opening the future





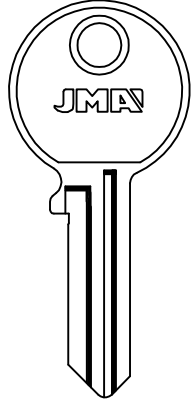
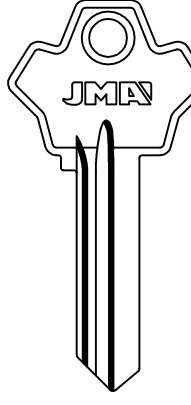
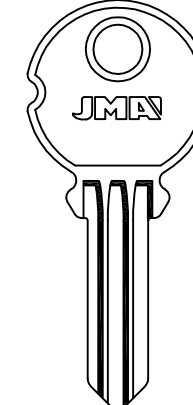
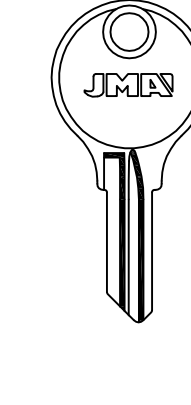
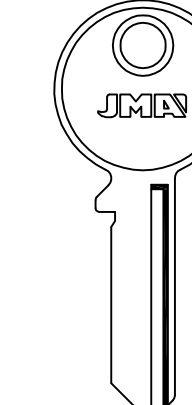



Beziehen auf die marke und handelsname sehen sie die notiz im Impressum.  
Relativamente às marcas e denominações comerciais, ver aviso legal.  
Jeśli chodzi o znaki i nazwy handlowe, patrz Informacje prawne.

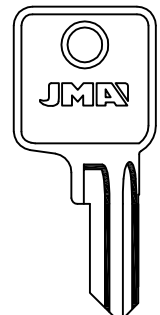
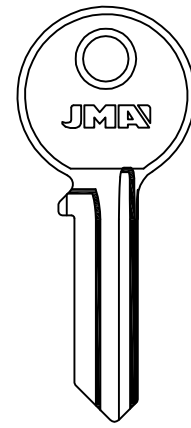
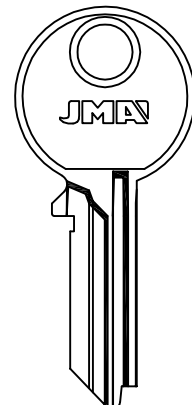
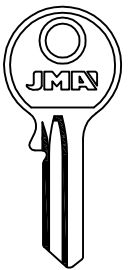
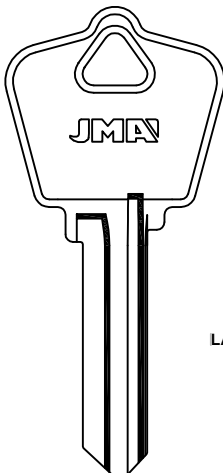





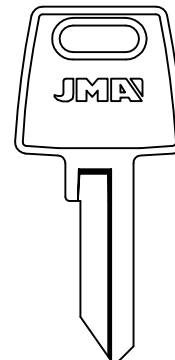
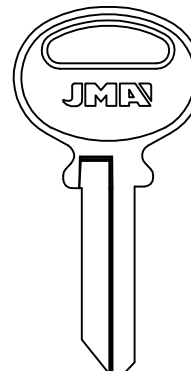
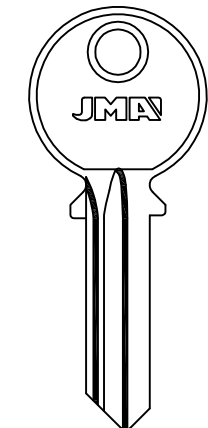
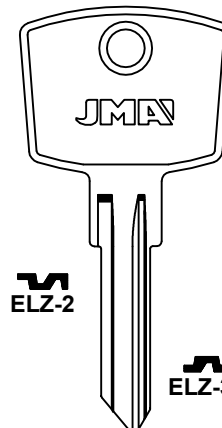
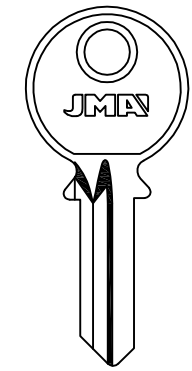

**FOR: DOM®**

 LAT.	 DOM-73D	 FOR: STUV®	 DOM-71D	 DOM-64D	 DOM-66D
	 DOM-65		 DOM-67D		
	 DOM-61		 DOM-60D		
	 DOM-59				
	 DOM-57		 DOM-57D		
	 DOM-55		 DOM-55D		
	 DOM-62D		 DOM-64D		

<b>FOR: DOUBLE CIRCLE®</b>	<b>FOR: DURALOCK®</b>	<b>FOR: EAG®</b>	<b>FOR: EAGLE®</b>	<b>FOR: ECM®</b>
 DC-4D	 DUR-1D	 EG-1	 EAG-2D	 EC-1
	LAT.	 EG-2	 EAG-2D	
			 EZ... PZ... 1-240	 EC-1D

<b>FOR: DOM®</b>	<b>FOR: DOMINION LOCK®</b>	<b>FOR: DOMUS®</b>
 FOR: GEWIRU®	 FOR: PETERBORO®	 DO-2I
 DOM-77D	 DOI-4	
 CL...1-250  GP...1-250  C...1001-1200  C...1301-1500  DOM-68	 DOI-1	 DO-2I

<b>FOR: EIKO®</b>	<b>FOR: ELZETT®</b>			
 EI-1D	 EI-2D	 FOR: TIEFENTHAL® -TUTIS®	 ELZ-2	 ELZ-6D
	FOR: CINA®	 ELZ-1D	 ELZ-3D	
		 ELZ-4	 ELZ-4D	 ELZ-5D

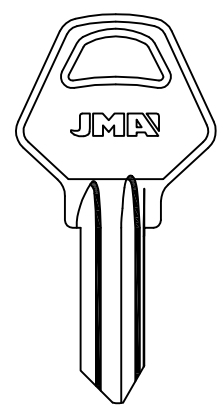
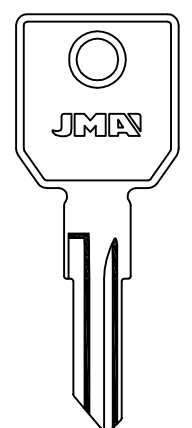
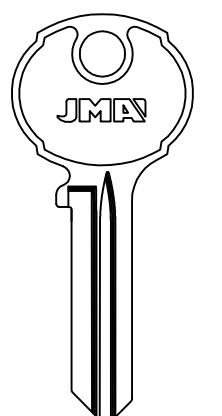
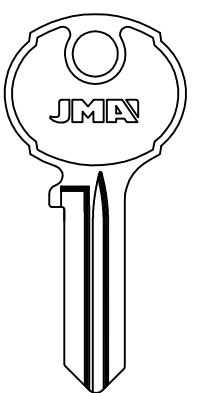
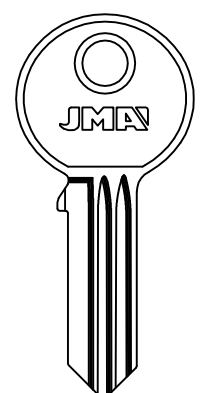
<b>FOR: DOMUS®</b>	<b>FOR: DOUBLE CIRCLE®</b>			
 DO-5	 DO-5D	 DC-1D	 DC-2D	 DC-3
			FOR: TRI CIRCLE®	

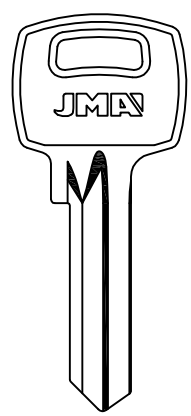
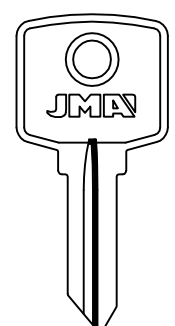
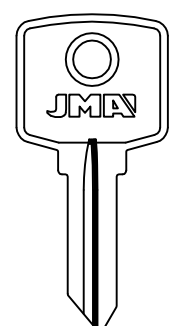
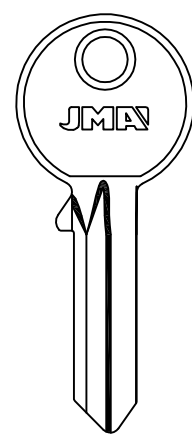
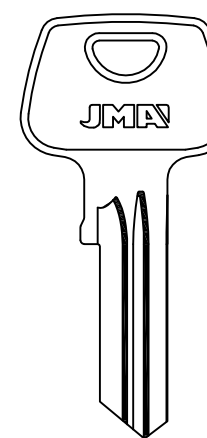
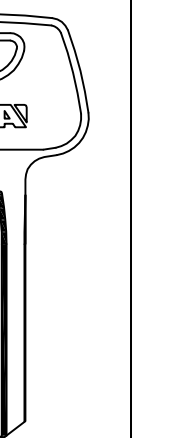
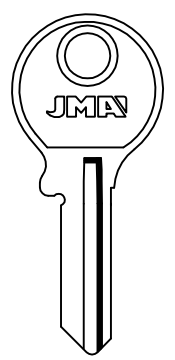
<b>FOR: ELZETT®</b>					<b>FOR: EMKA®</b>	
 ELZ-8D	 ELZ-14D	 ELZ-9	 ELZ-11D	 ELZ-12	 ELZ-12D	 EMK-1

Concerning the marks and commercial denominations see legal warning.  
 Concerniente a las marcas y denominaciones comerciales ver aviso legal.  
 Marka eta izendapen komertzialiei dagokienez, ikus lege-oharra.  
 Concernant les marques et dénominations commerciales voir la note dans l'index.

FOR: EP PINSON®

FOR: ERA®

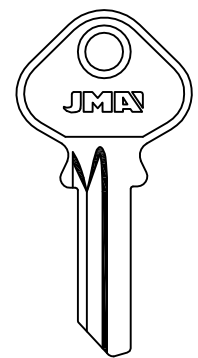

EP-1D

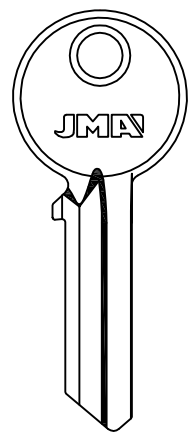

ER-1D

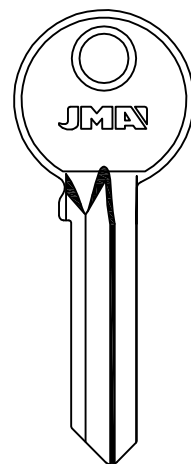

ER-2D

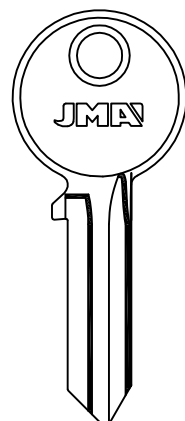

ER-3



ER-4D

LAT.

FOR: ESA®

FOR: ESLA®

FOR: ESP®

FOR: ESS®

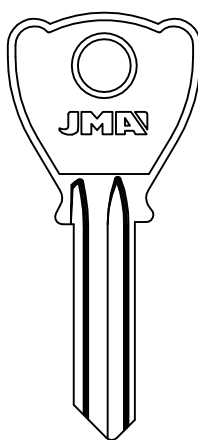

FOR: NUMIDA®

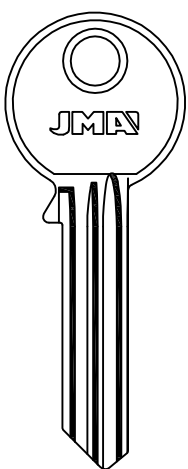

FOR: CISA®

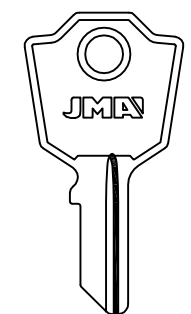

FOR: FKS®-ELEDIS®

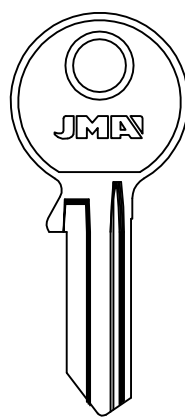

FOR: WT®

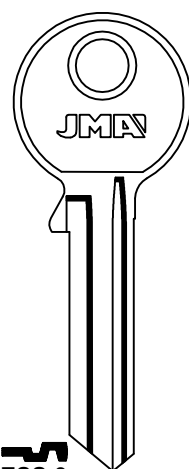

FOR: BRABANTIA®-MARS®-WEDO®

FOR: ESS®

FOR: ETAS®

FOR: EUREKA®

FOR: EURO BOX®

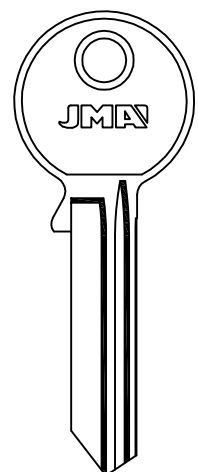

FOR: BAB®

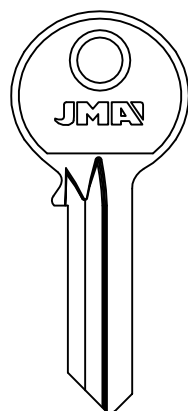

FOR: YANEDIS®

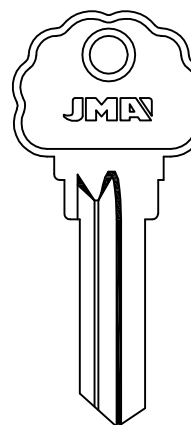

FOR: WT®

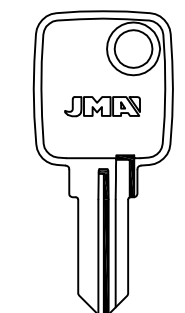

FOR: WT®

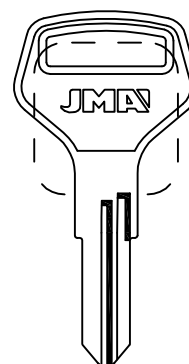

FOR: BRABANTIA®-MARS®-WEDO®

FOR: EURO LOCKS®

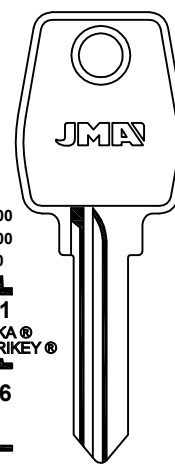

47001-48000  
45000-47000  
1201-1400  
EU-1  
FOR: EMKA®  
FOR: SECURIKEY®  
EU-6



EU-10D



EU-14D



25001-27000  
EU-2

FOR: FASMA®-L.&F.®-MERONI®



EU-3

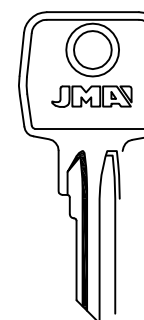

...A  
458-5124



EU-4

...E  
405-4324



EU-4D

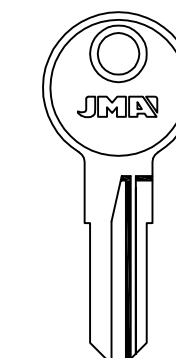

EU-7



EU-7D



EU-11

FOR: EUROLOCKS®

FOR: EURO-PROFIL®

FOR: EVERGOOD®

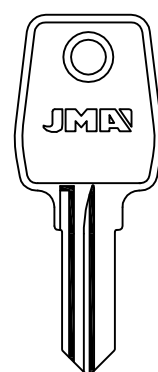

KB  
1-500  
EU-17



FOR: L&F®

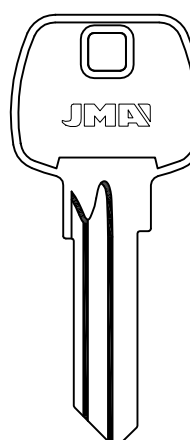

FOR: GERDA®

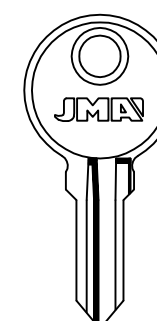

FOR: ARREGUI®

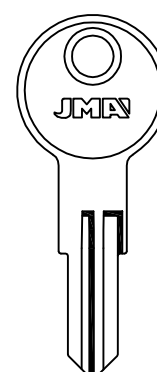

FOR: ARREGUI®



FOR: ARREGUI®

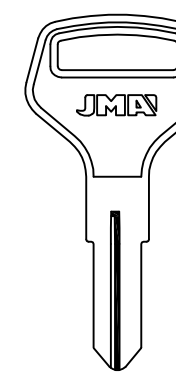

FOR: ARREGUI®



FOR: ARREGUI®

FOR: EVERGOOD®

FOR: EVA®

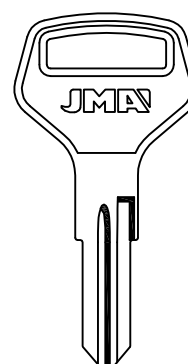

FOR: ELCA®

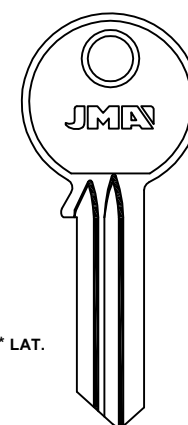

\* LAT.

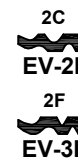

FOR: ELCA®



EV-1



EV-2



EV-3D



EV-13D



EV-15D



EV-25D

FOR: ELCA®

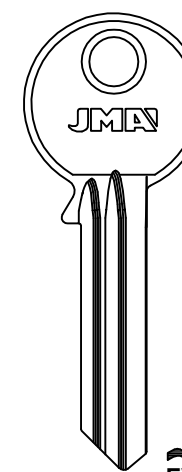

EV-4D

FOR: ELCA®

Concerning the marks and commercial denominations see legal warning.  
Concerniente a las marcas y denominaciones comerciales ver aviso legal.  
Marka eta izendapen komertzialiei dagokienez, ikus lege-oharra.  
Concernant les marques et dénominations commerciales voir la note dans l'index.

**JMA** Opening the future

**JMA** Opening the future

Beziehen auf die Marke und Handelsname sehen sie die Notiz im Impressum.  
Relativamente às marcas e denominações comerciais, ver aviso legal.  
Jeśli chodzi o znaki i nazwy handlowe, patrz Informacje prawne.

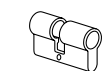

FOR: EVVA®

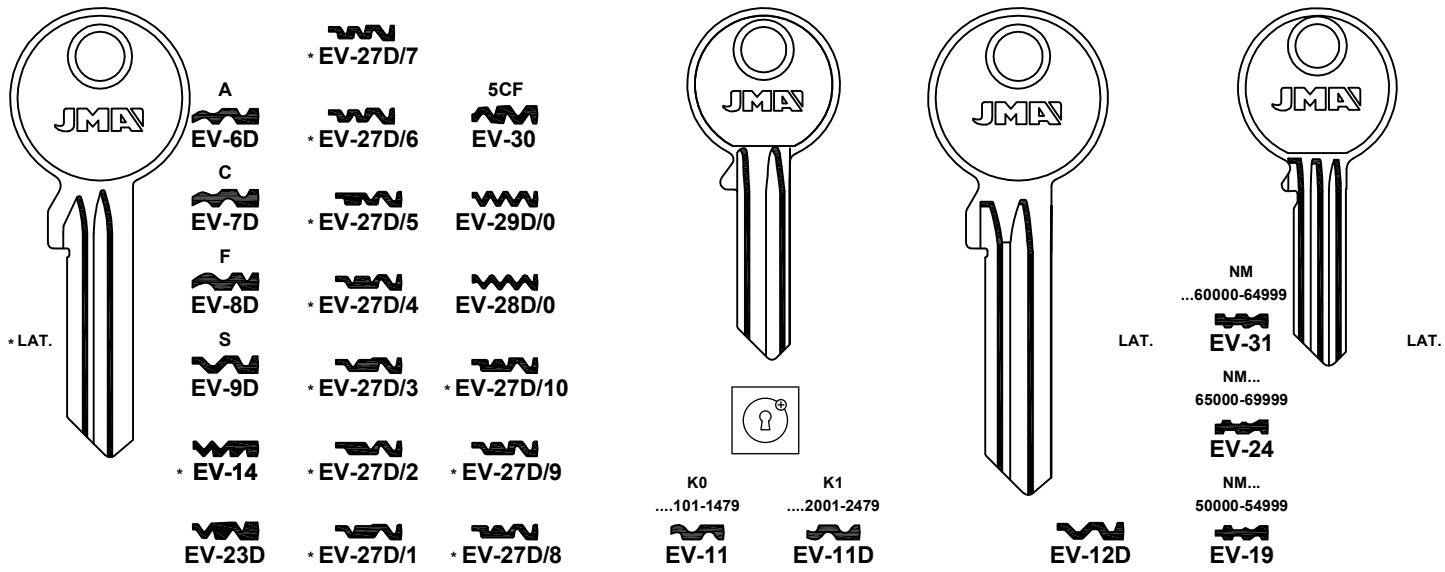

FOR: ELCA®-TRYBA®-GE GE®-EVVA TSC®-WORTH®

FOR: FAB®

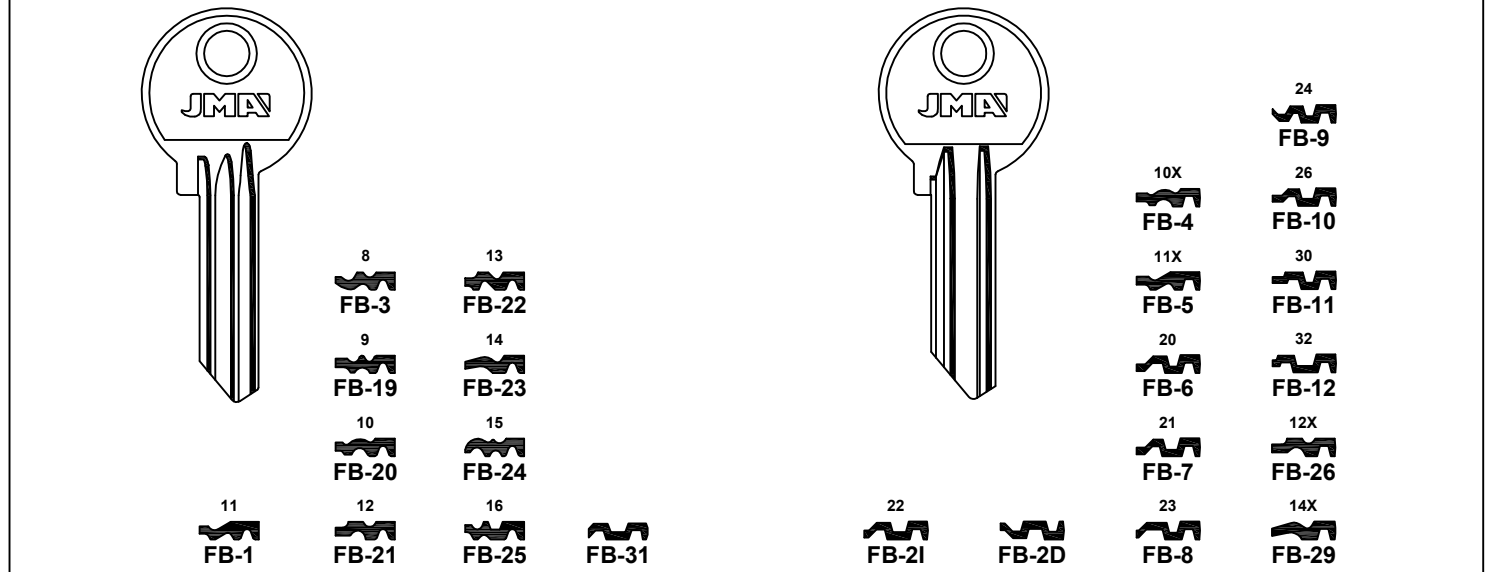

FOR: EVVA®

FOR: EXCEL®

FOR: EXPRES®

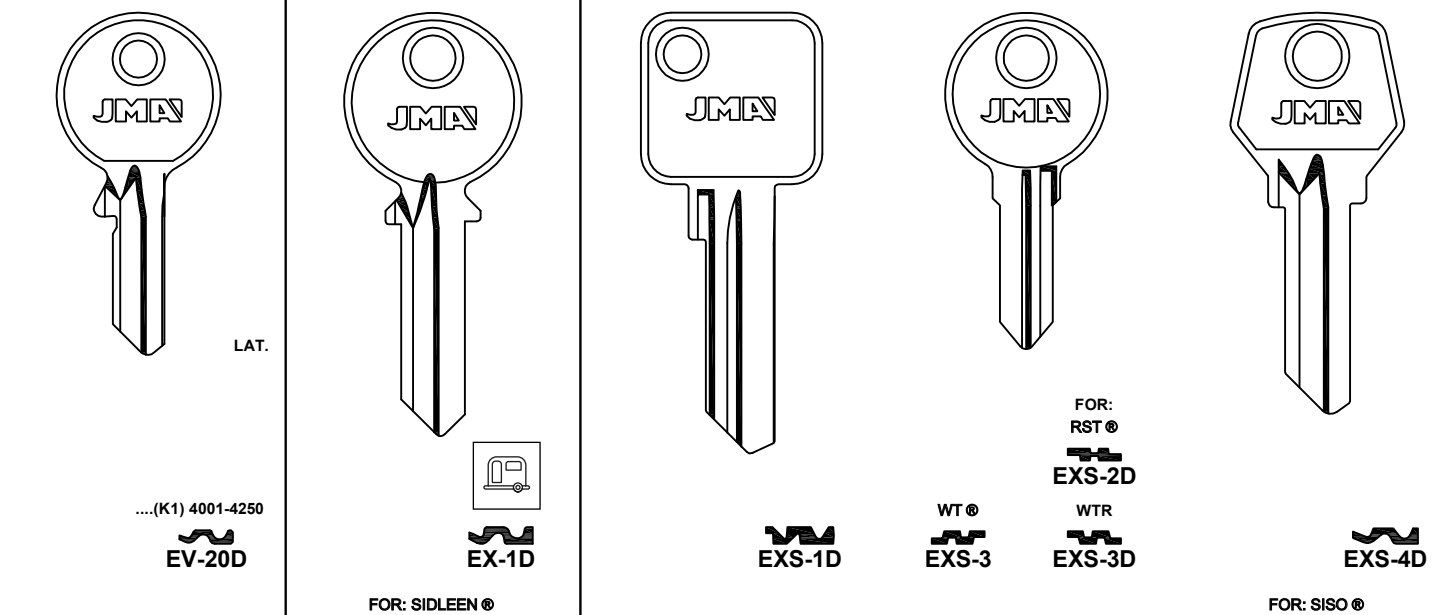

FOR: SIDLEEN®

FOR: SISO®

FOR: FAB®

FOR: FAC®

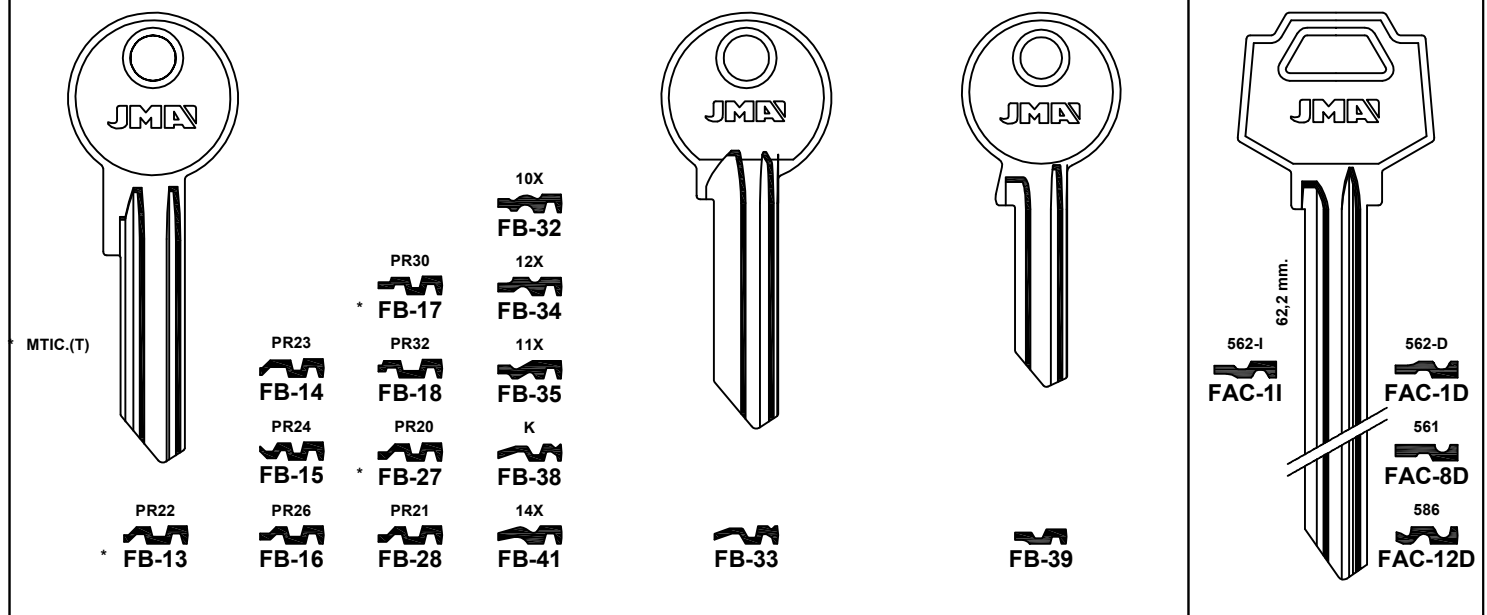

FOR: EXPRES®

FOR: EZCURRA®

FOR: FAC®

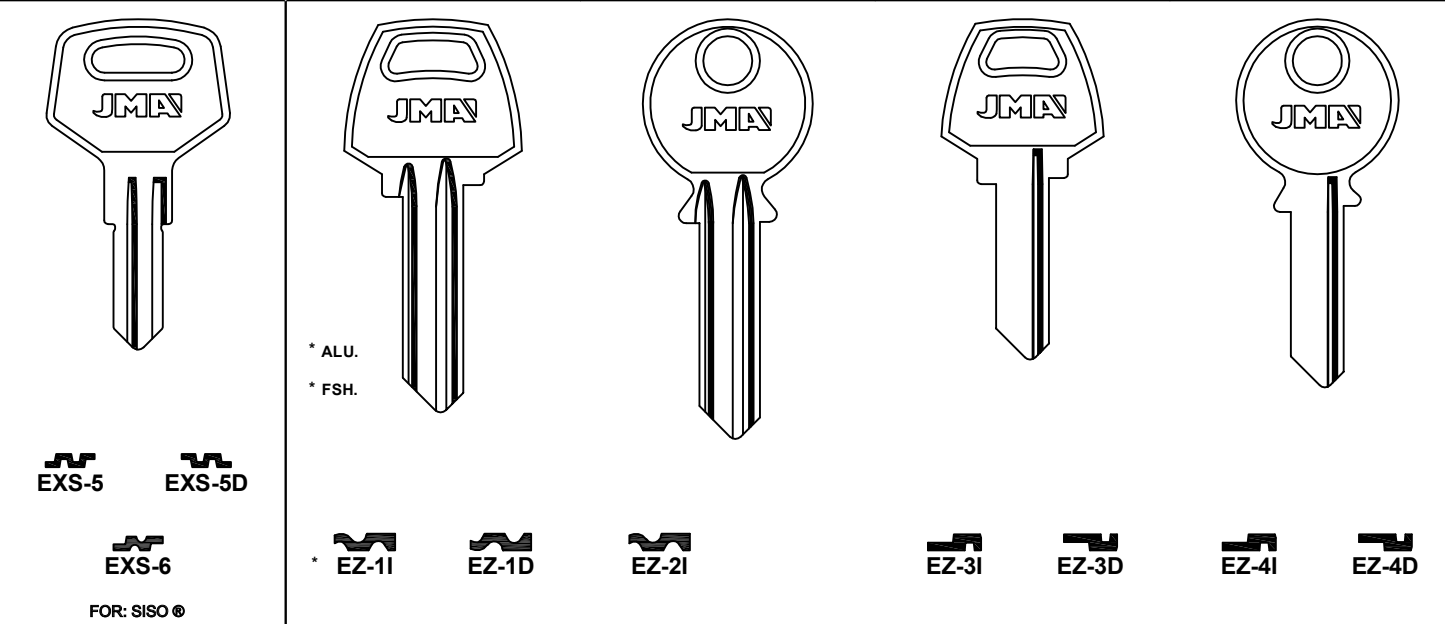

FOR: SISO®

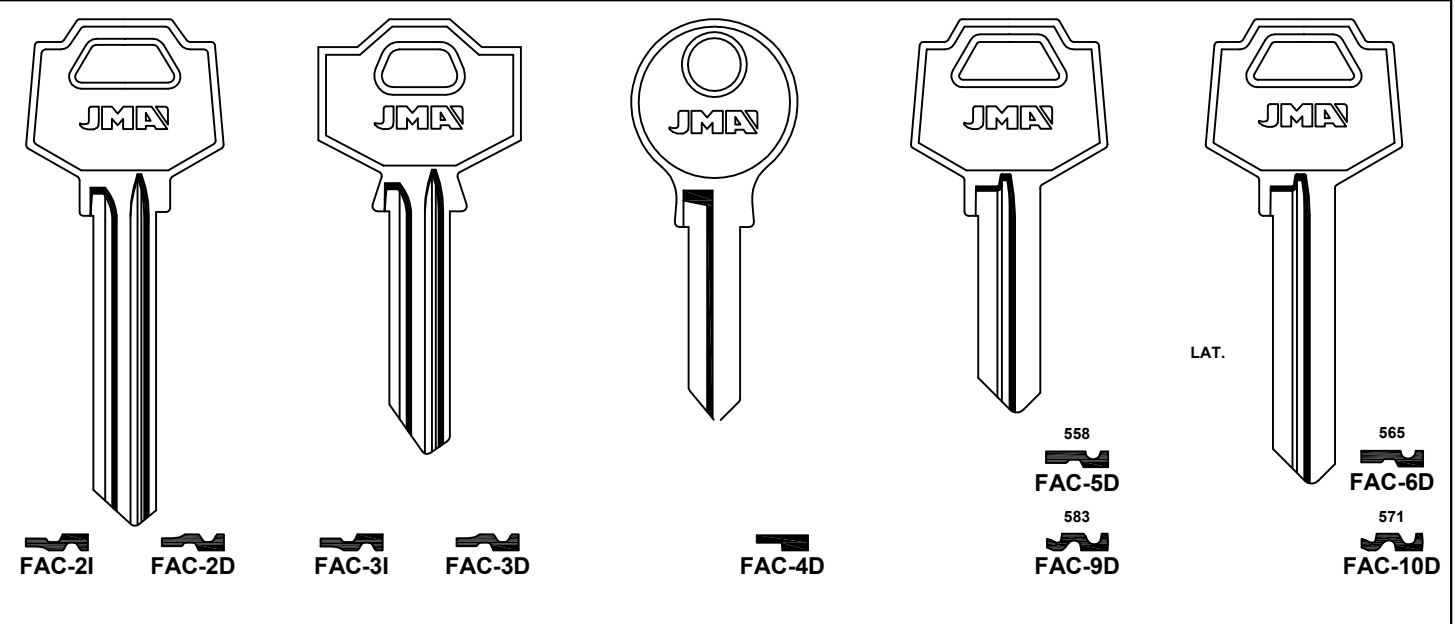

Concerning the marks and commercial denominations see legal warning.  
 Concerniente a las marcas y denominaciones comerciales ver aviso legal.  
 Marka eta izendapen komertzialiei dagokienez, ikus lege-oharra.  
 Concernant les marques et dénominations commerciales voir la note dans l'index.

**JMA** Opening the future

**JMA** Opening the future

Beziehen auf die Marke und Handelsname sehen Sie die Notiz im Impressum.  
 Relativamente às marcas e denominações comerciais, ver aviso legal.  
 Jeśli chodzi o znaki i nazwy handlowe, patrz Informacje prawne.

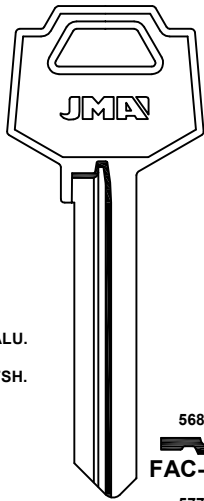
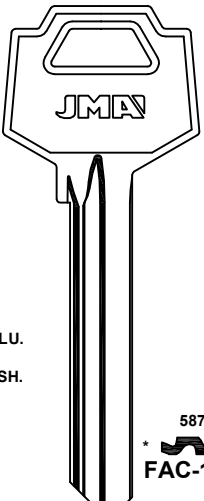
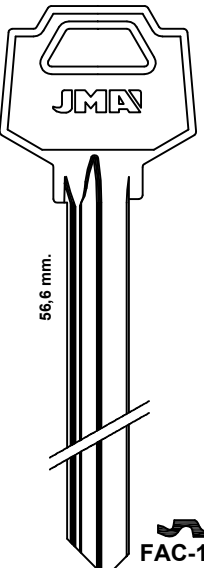
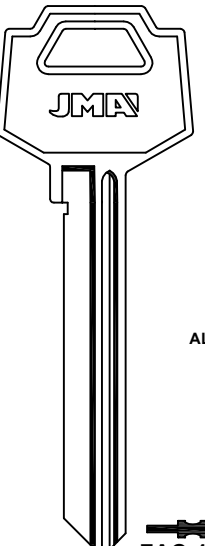
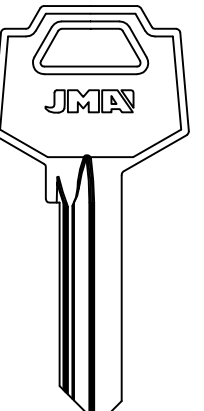

**FOR: FAC®**

				
* ALU. * FSH. 568 FAC-7D 577 FAC-11D	* ALU. * FSH. 587 FAC-13D FAC-15	56,6 mm. FAC-14D	ALU. FAC-18	FAC-20D

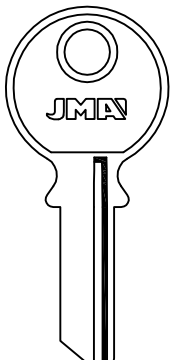
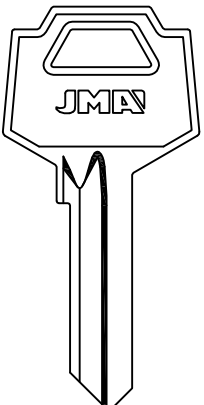

**FOR: FAC®**

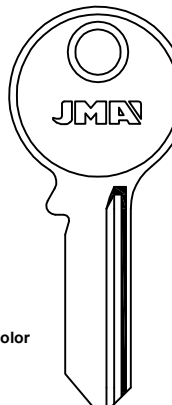
	
FAC-21	FAC-21D

**FOR: FAINER®**

	
WColor FAIN-11	WColor FAIN-11

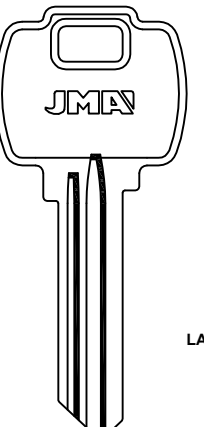
**FOR: FALCON®**

	
LAT. FAL-1D	FAL-2D

**FOR: FAMA®**

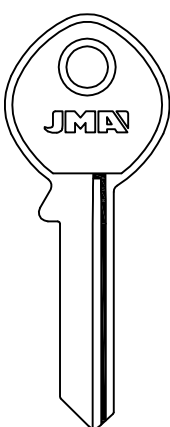
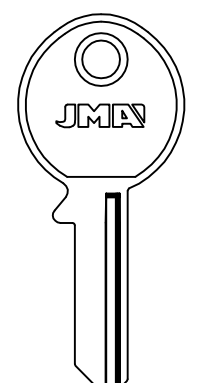
	
FAM-1	FAM-2

**FOR: FANA®**

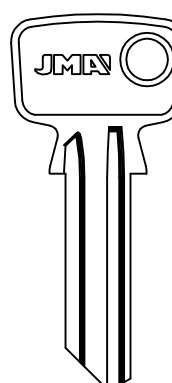
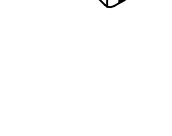
	
FAN-1	FAN-1D

**FOR: FAS®**

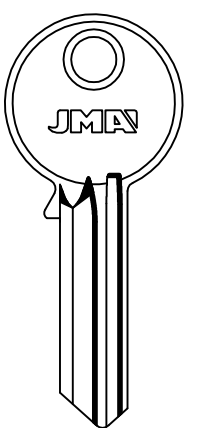
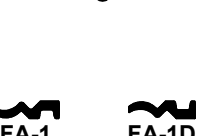
	
FA-1	FA-1D

**FOR: FASEM®**

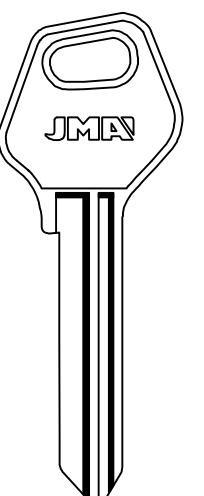
FAS-1

**FOR: FAVOUR®**

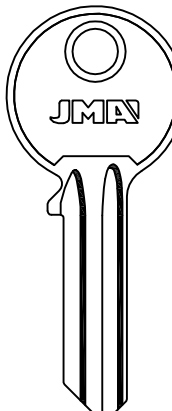
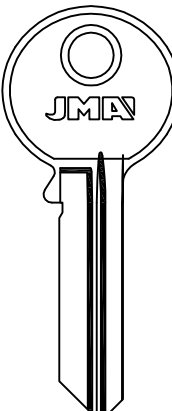
	
FAV-3	FAV-3D

**FOR: FCV®**

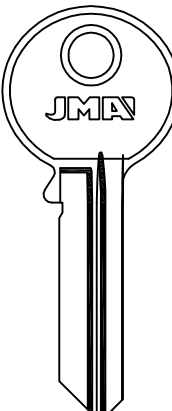

FV-1D

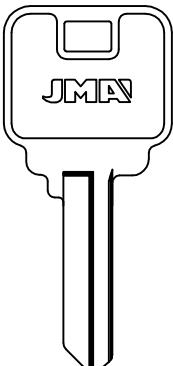
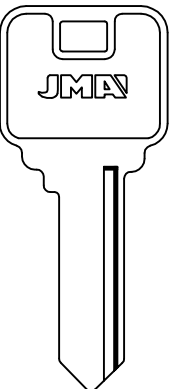
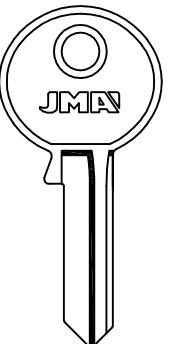
**FOR: FECHADURA®**

		
FEC-1D	FEC-2	FEC-3D

**FOR: STAM®**

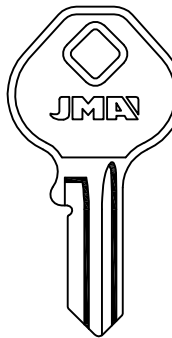
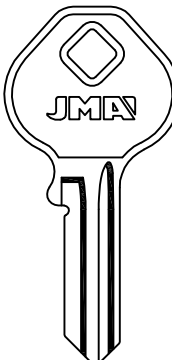
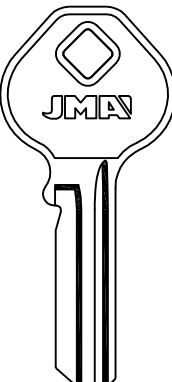
**FOR: FEDERAL®**

		
FED-1	FED-2	FED-3

**FOR: FERONERIA®**

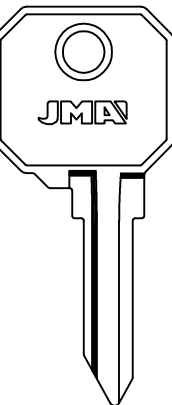
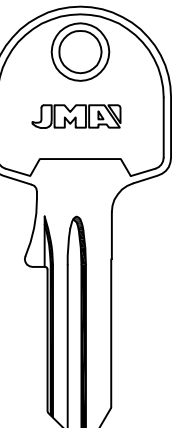
	
FER-1	FER-3D





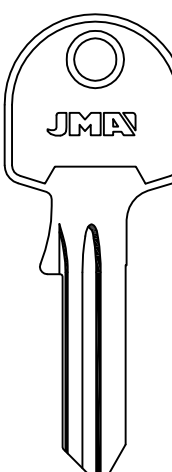

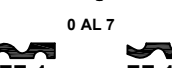

**FOR: VF (VEROFER)®**

**FOR: FERONERIA®**

FER-4D

**FOR: VF (VEROFER)®**

**FOR: F.F.®**

								
0 AL 7 FF-1	0 AL 7 FF-1D	0 AL 7 FF-2	0 AL 7 FF-2D	FF-3	FF-10D	FF-5D	FF-6	FF-11

**FOR: GUARDIAN®**

Concerning the marks and commercial denominations see legal warning.  
 Concerniente a las marcas y denominaciones comerciales ver aviso legal.  
 Marka eta izendapen komertzialiei dagokienez, ikus lege-oharra.  
 Concernant les marques et dénominations commerciales voir la note dans l'index.

**JMA®** Opening the future

**JMA®** Opening the future

Beziehen auf die marke und handelsname sehen sie die notiz im Impressum.  
 Relativamente às marcas e denominações comerciais, ver aviso legal.  
 Jeśli chodzi o znaki i nazwy handlowe, patrz Informacje prawne.

FOR: F.F.®



FF-7D FF-8D FF-9D FF-10GD

FOR: FIC®

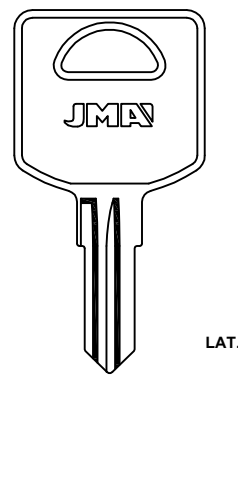

LAT.  
FCS-1D

FOR: FORT®

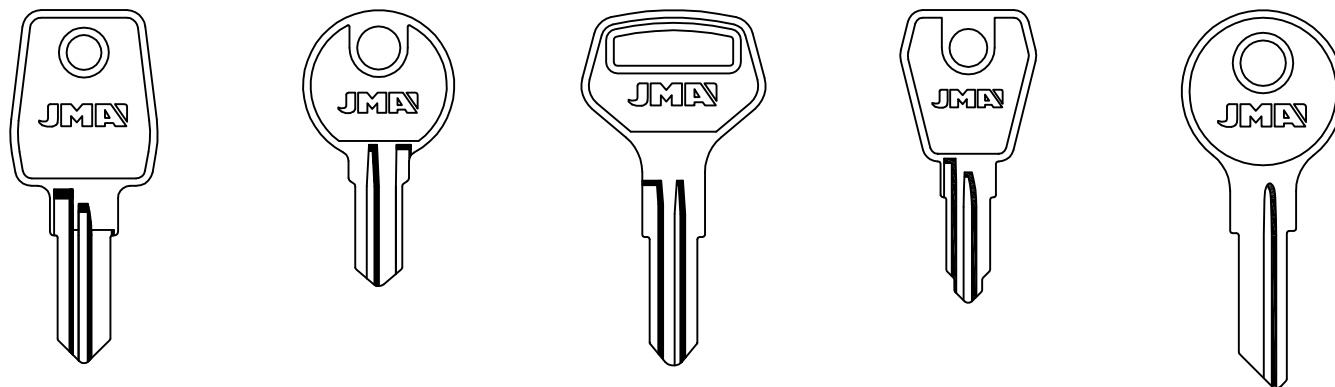

FR-2 FR-4 FR-8 FR-9D FR-11D  
FR-1D  
601-700  
FR-7D  
501-600  
FG  
FOR: DAD®-LOWE&FLETCHER® FOR: ARREGUI® FOR: ABUS®-SECURITAL®

FOR: FICHET®

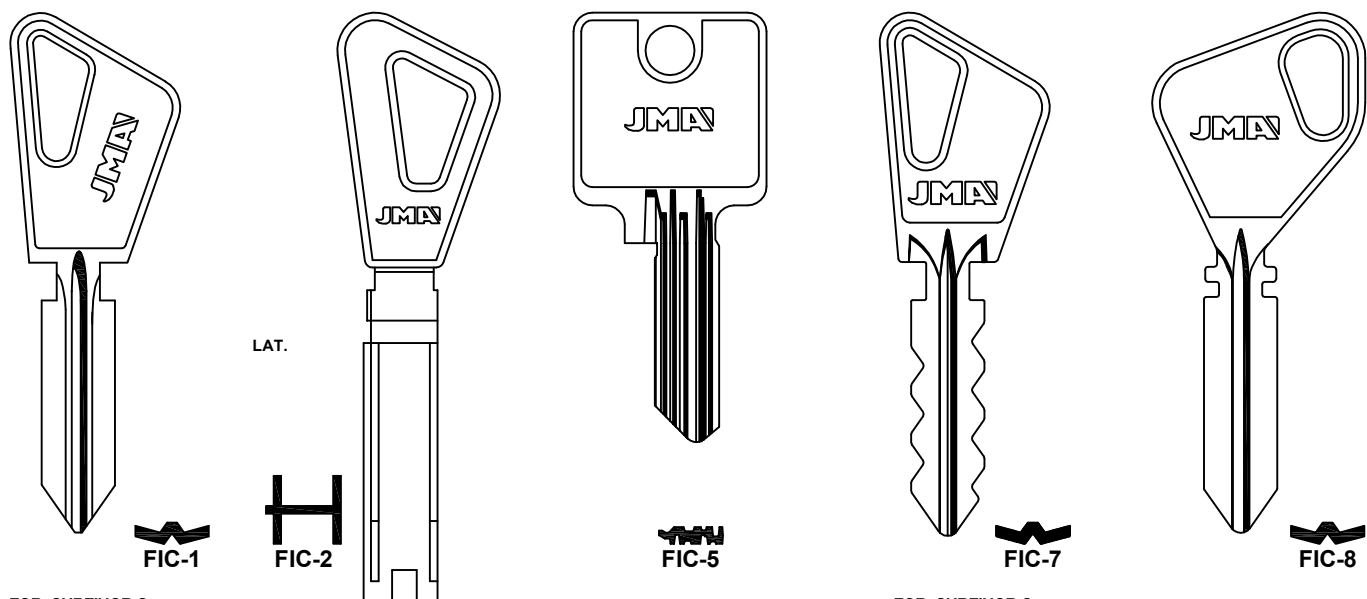

LAT.  
FIC-1 FIC-2 FIC-5 FIC-7 FIC-8  
FOR: SURFINOR®

FOR: FORTE®

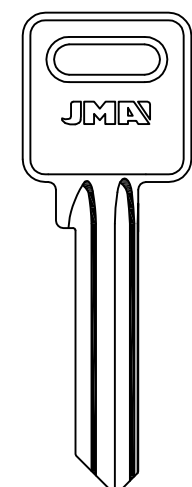

FTE-1 FTE-1D

FOR: FORTIS®

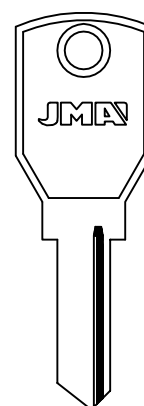

FORTIS-2I

FOR: FTH®

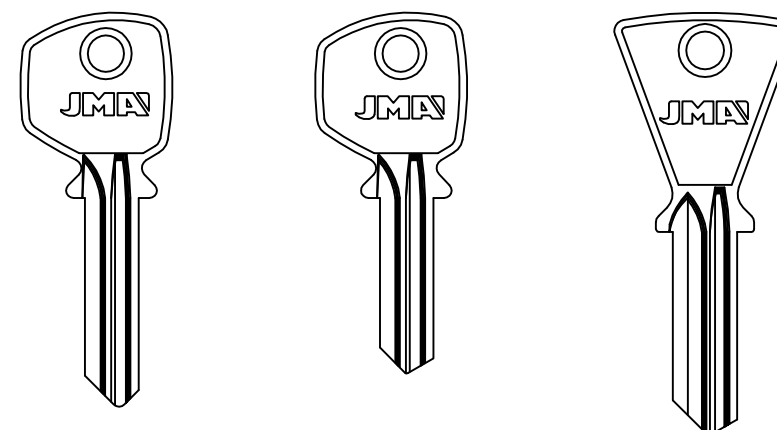

TD-1 TD-1D TD-8 TD-8D TD-2 TD-3

FOR: FICHET®

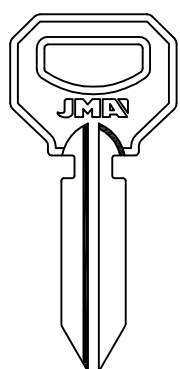

FIC-9

FOR: TECNOR®

FOR: FIST®

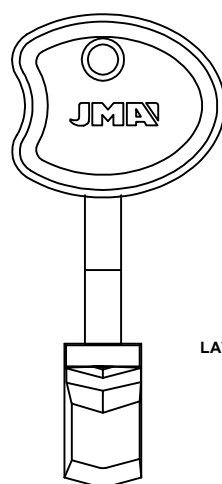

FIC-18

FOR: FLORA®

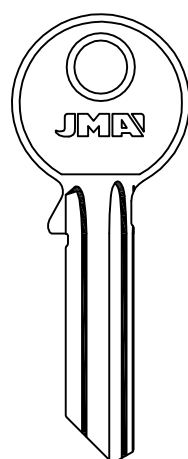

FLO-1 FLO-1D

FOR: FLOHR®-NB®-NORDWEST®-SUKI®

FOR: FONTAINE®

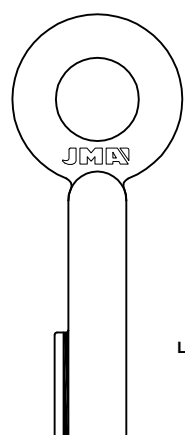

LAT.  
FON-2E FON-5E

FOR: PROGRES®

FOR: FTH®

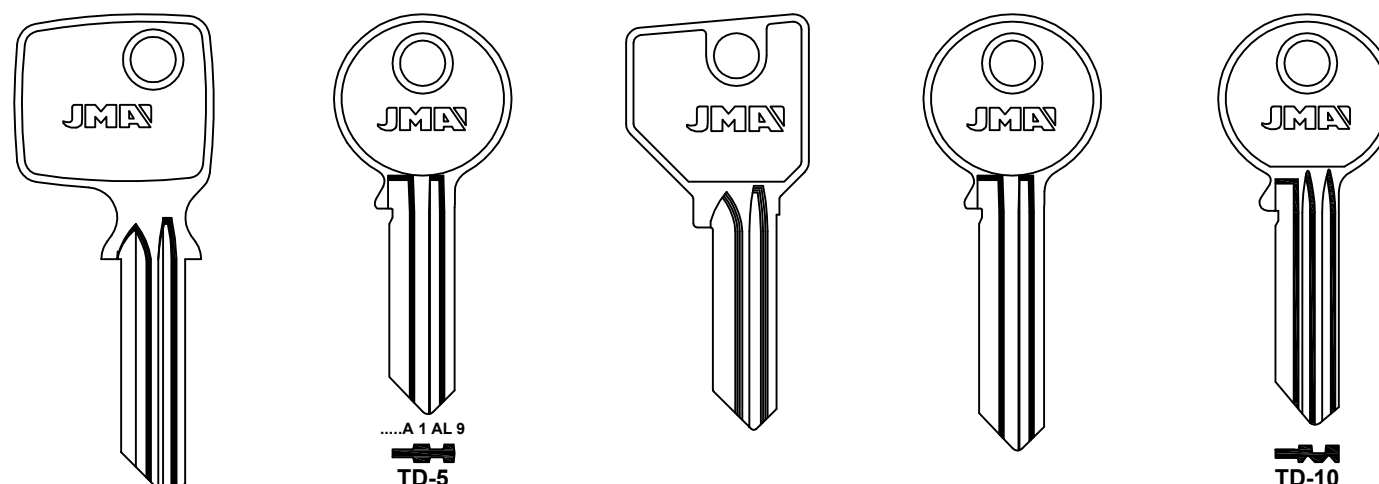

TD-4

.....A 1 AL 9  
TD-5

TD-22

TD-6

.....A 1 AL 9  
TD-9

TD-10

TD-21

FOR: CF®-CB®-IFAM®-JL®-NICO®-PROBAT®  
FOR: CIBC®-CITY®-SUF®

Concerning the marks and commercial denominations see legal warning.  
Concerniente a las marcas y denominaciones comerciales ver aviso legal.  
Marka eta izendapen komertzialiei dagokienez, ikus lege-oharra.  
Concernant les marques et denominations commerciales voir la note dans l'index.

**JMA**® Opening the future

**JMA**® Opening the future

Beziehen auf die marke und handelsname sehen sie die notiz im Impressum.  
Relativamente às marcas e denominações comerciais, ver aviso legal.  
Jeśli chodzi o znaki i nazwy handlowe, patrz Informacje prawne.

FOR: FTH®

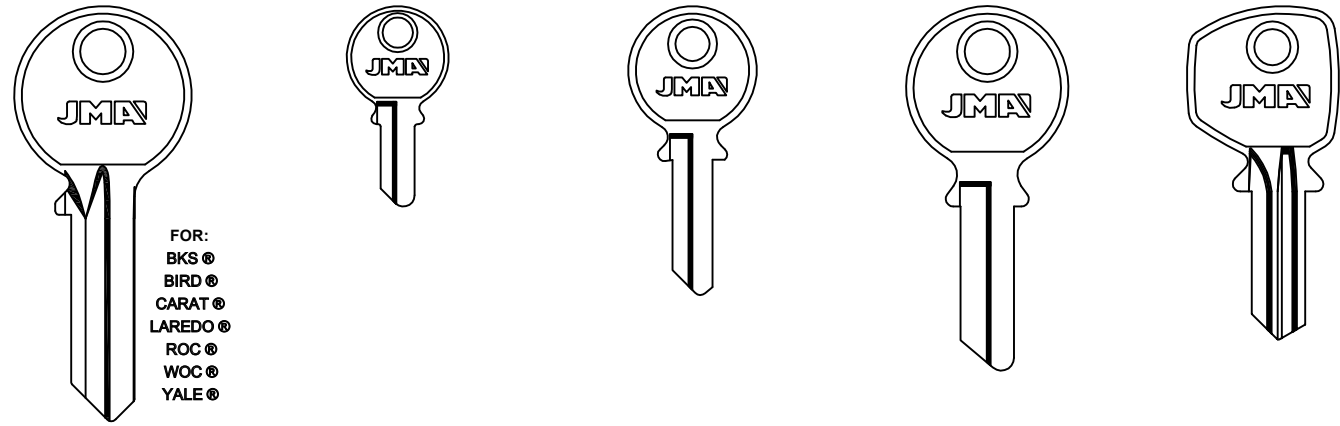

FOR:  
BKS®  
BIRD®  
CARAT®  
LAREDO®  
ROC®  
WOC®  
YALE®



FOR: GAMET®

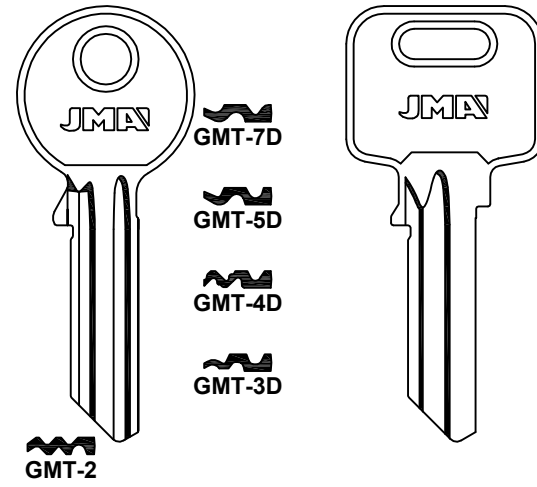

GMT-7D  
GMT-5D  
GMT-4D  
GMT-3D  
GMT-2



FOR: EXPRES®

FOR: GATO®

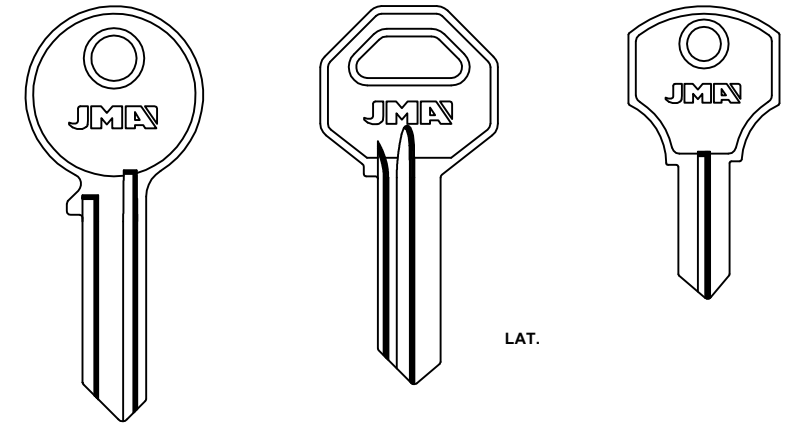

LAT. LAT.



FOR: FTH®

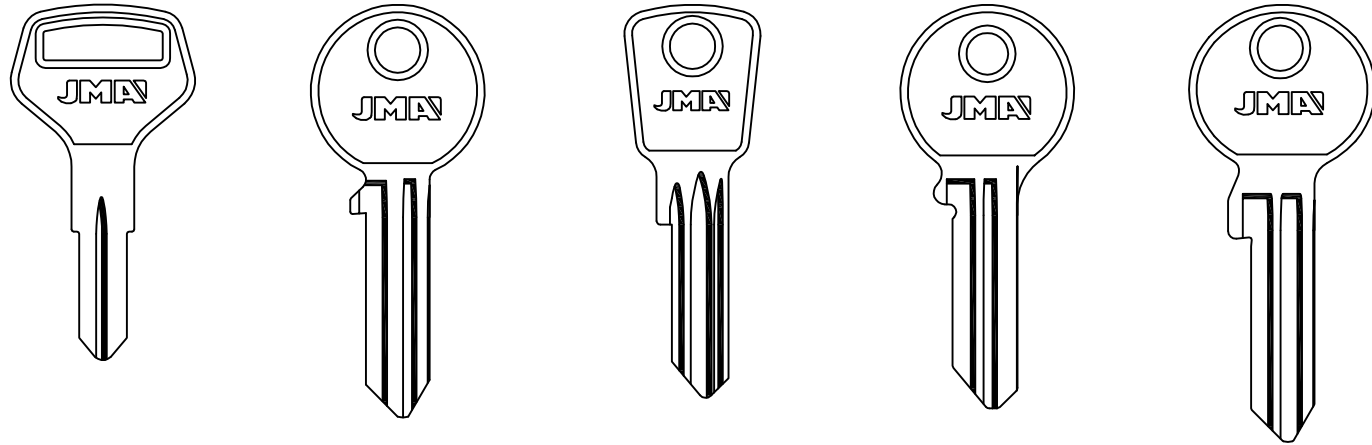

FOR: FEDERAL®

FOR: HERACLES®

FOR: GBZ®

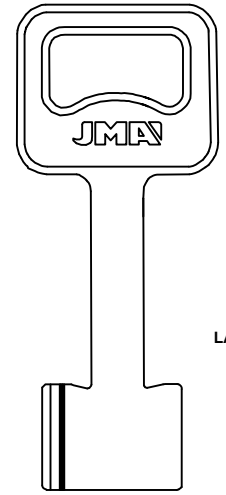

LAT.



FOR: GE-GE®

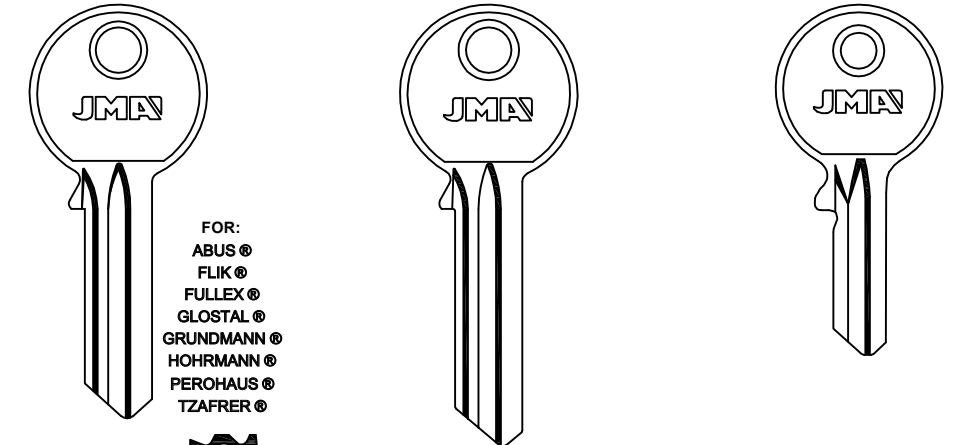

FOR:  
ABUS®  
FLIK®  
FULLEX®  
GLOSTAL®  
GRUNDMANN®  
HOHRMANN®  
PEROHAUS®  
TZAFRER®

GE-1D



FOR: ALFA® -FINSTRAL®

FOR: LABOFA® -PEROHAUS®

FOR: FTH®

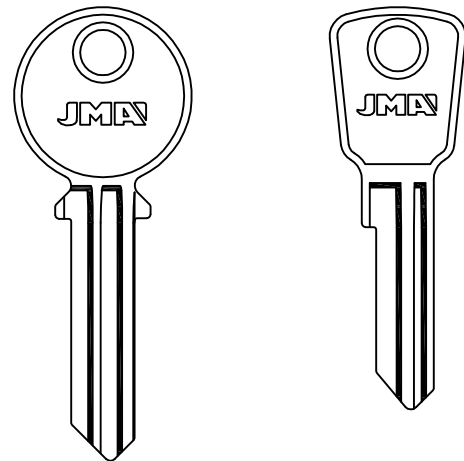

FOR: FEDERAL®

FOR: FULTON HITCH®

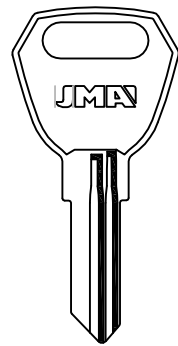

LAT.



FOR: GABON®

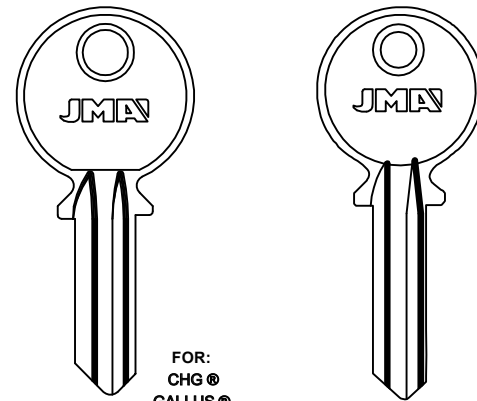

FOR:  
CHG®  
GALLUS®  
MAXIGARD®  
PICARDIE®  
SOS®  
WINNER®



FOR: CHG® -GALLUS® -MAXIGARD®  
FOR: PICARDIE® -SOS® -WINNER®

FOR: GE-GE®

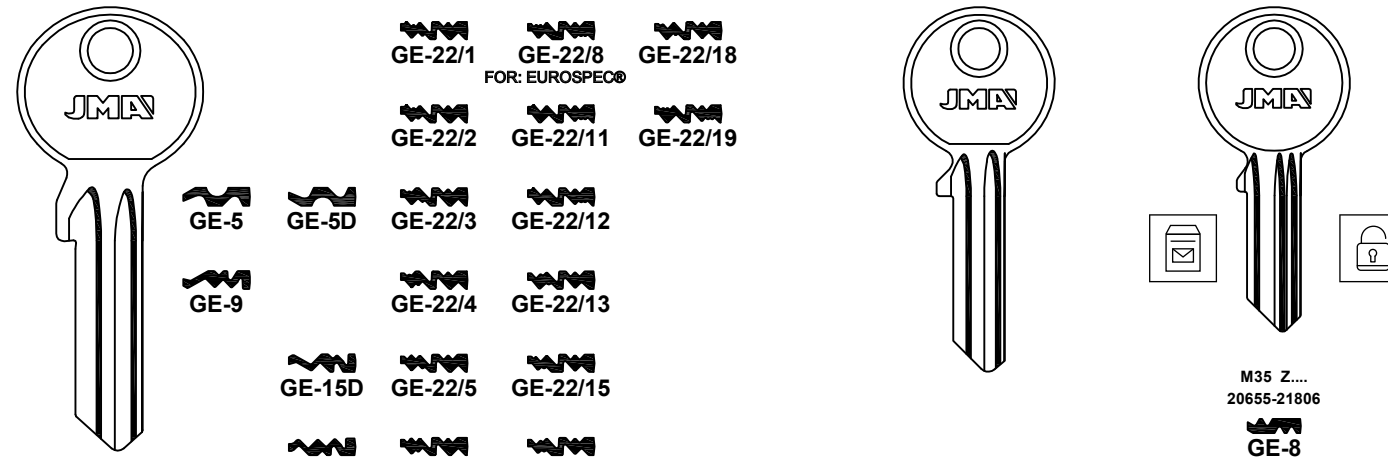

GE-22/1 GE-22/8 GE-22/18  
FOR: EUROSPEC®  
GE-22/2 GE-22/11 GE-22/19

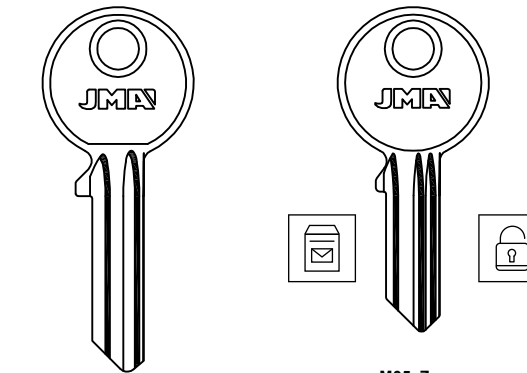

FOR: PEROHAUS®

M35 Z....  
20655-21806  
GE-8  
M25 Z....  
9135-10286  
GE-7

Concerning the marks and commercial denominations see legal warning.  
Concerniente a las marcas y denominaciones comerciales ver aviso legal.  
Marka eta izendapen komertzialiei dagokienez, ikus lege-oharra.  
Concernant les marques et denominations commerciales voir la note dans l'index.



FOR: GE GE®

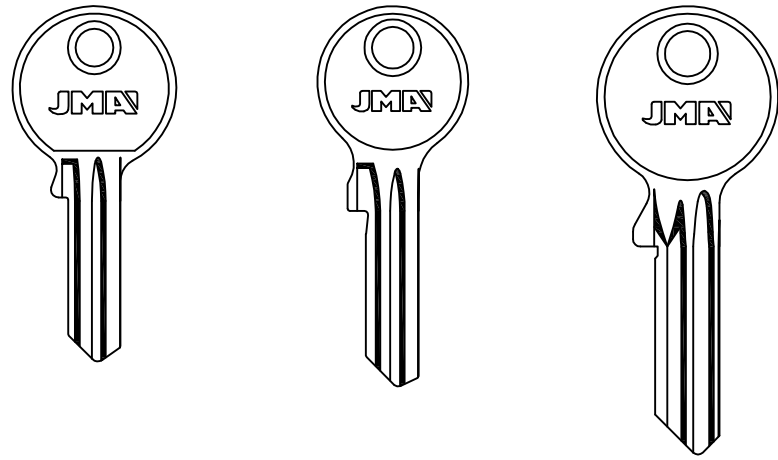

GE-10D GE-11 GE-21 GE-21D

FOR: GEBA®

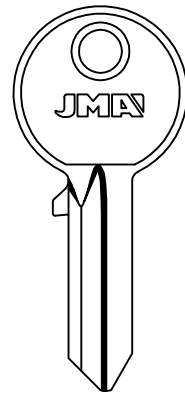

GEB-1D

FOR: GERA®

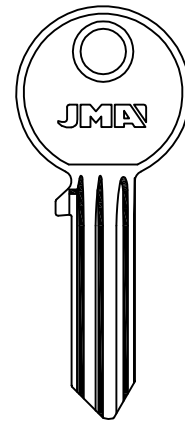

GEA-1

FOR: GERDA®



GDA-5T GDA-6D GDA-30I GDA-7D GDA-8D GDA-5B  
FOR EUROPROFIL® FOR EUROPROFIL® FOR EUROPROFIL®

FOR: GERA®

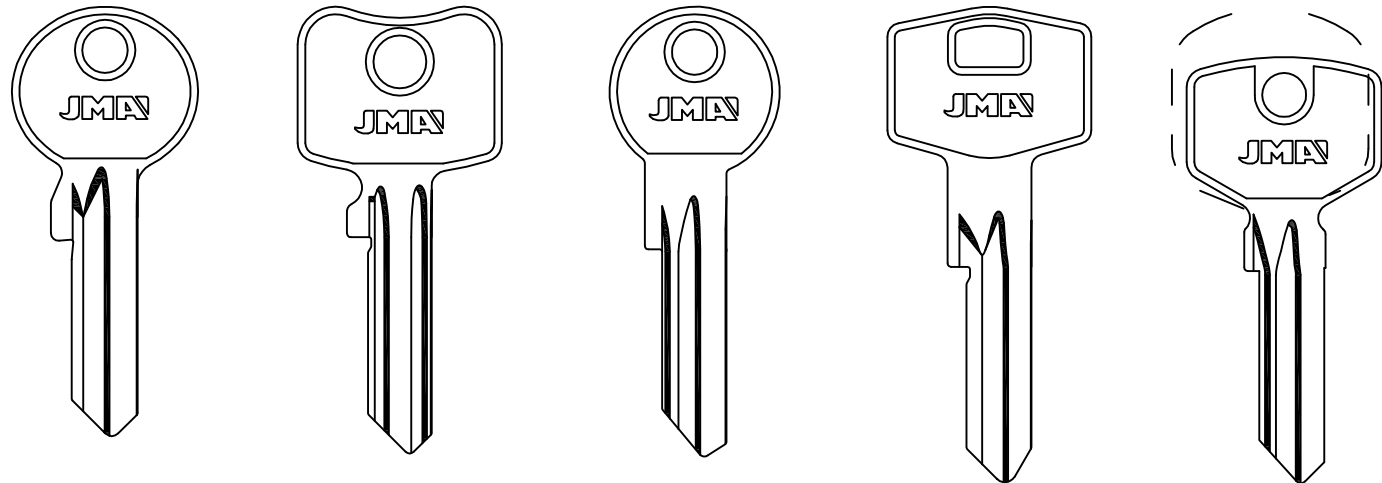

GEA-2D GEA-3 GEA-4D GEA-5D GEA-6D PZ6900

FOR: ROTO®-BUVA®

FOR: GIBBONS®

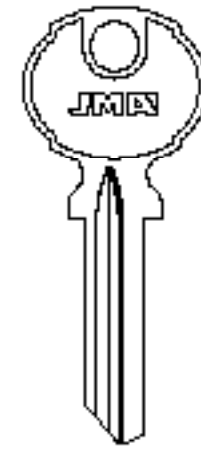

GB-1D FOR: WILSON®

FOR: GIUSSANI®

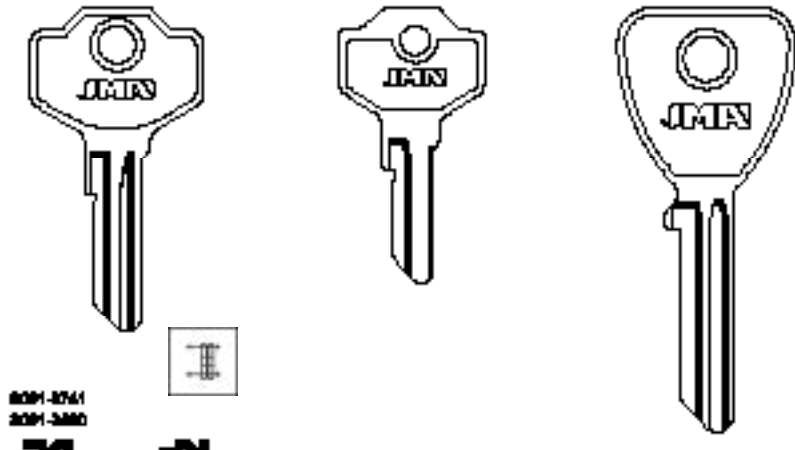

GIU-1 GIU-1D GIU-2 GIU-2D GIU-3D GIU-4  
FOR: SIMON®-EPM® FOR: OAL®-LINE®

FOR: GLAZIEV®

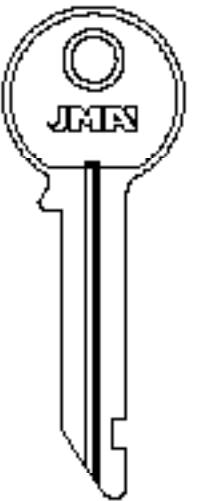

GLA-1D

FOR: GERA®

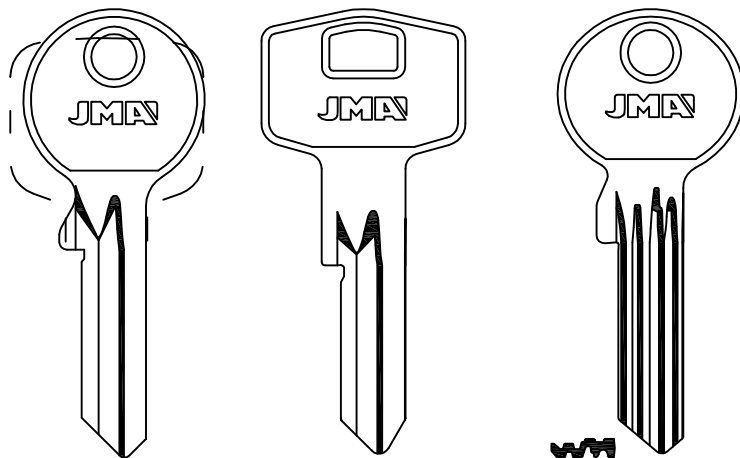

GEA-7D GEA-8D GEA-9/1 GEA-9/3 GEA-9/13 GEA-9D/5 GEA-9/4 GEA-9/14 GEA-9D/7 GEA-9/6 GEA-9D/8 GEA-9/7 GEA-9D/12 GEA-9/9 GEA-9/10

FOR: GERDA®

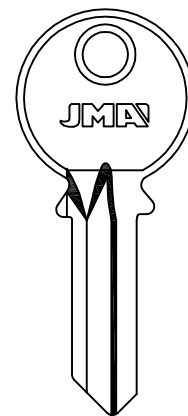

GDA-3D

FOR: GLAZIEV®

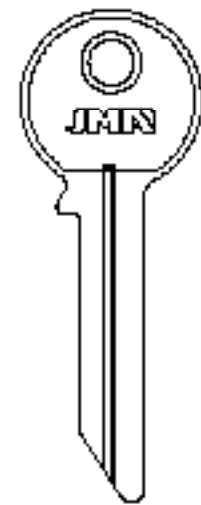

GLA-2D

FOR: GLOBE®

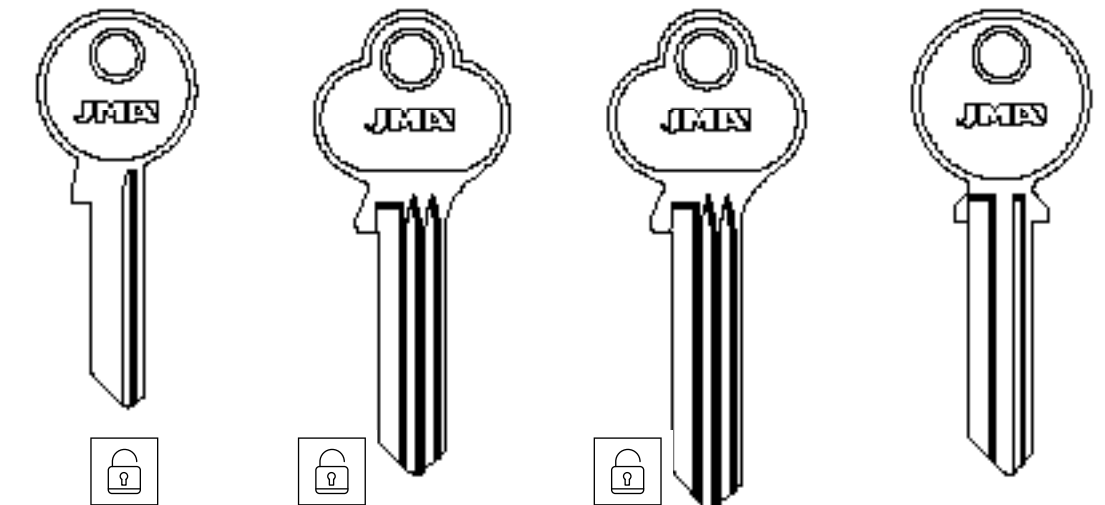

GLO-1 GLO-1D GLO-2 GLO-2D GLO-3 GLO-3D GLO-4 GLO-4D  
FOR: LAM®

Concerning the marks and commercial denominations see legal warning. Concerniente a las marcas y denominaciones comerciales ver aviso legal. Marka eta izendapen komertzialiei dagokienez, ikus lege-oharra. Concernant les marques et denominations commerciales voir la note dans l'index.

JMA® Opening the future

JMA® Opening the future

Beziehen auf die marke und handelsname sehen sie die notiz im Impressum. Relativamente às marcas e denominações comerciais, ver aviso legal. Ješli chodzí o znaki i nazwy handlowe, patrz Informacje prawne.

K01 / 53

FOR: GLOBE®

GLO-5I   GLO-6   GLO-6D   GLO-7   GLO-7D   GLO-8   GLO-8D   GLO-9D

FOR: MIAN® -FORCE®   FOR: GOLD DOOR®

FOR: GLOBE®

GLO-10   GLO-11   GLO-12D   GLO-22   GLO-22D   GLO-23   GLO-23D

FOR: GOLD DOOR®   FOR: ANLO® -LUCO®

FOR: GODREJ®

GOD-3   GOD-4

FOR: SHERLOCK®

FOR: GMB®

GB-1D   GB-2D

FOR: GR®

GRG-1

FOR: GTV®

GTV-2   GTV-1D   GTV-2D   GTV-3D   GTV-4D   GTV-5D

FOR: TIEFENTHAL®   FOR: JOWIL® -TIEFENTHAL®

FOR: GTV®

GTV-11   GTV-12

FOR: TIEFENTHAL®

FOR: GUARD®

GUA-1   GUA-1D   GUA-2   GUA-2D

FOR: FAB®

FOR: GUARD®

GUA-3   GUA-3D   GUA-4   GUA-4D

FOR: GUERVILLE R.®

GR-1   GR-1D   GR-2   GR-2D   GR-3   GR-3D   GR-4   GR-4D

FOR: PERRIER®

FOR: GUERVILLE R.®

GR-6   GR-6D   GR-7   GR-7D

FOR: GUSHENG®

GUS-1

FOR: HÄFELE®

HAF-1   HAF-1D

HAF-4

Concerning the marks and commercial denominations see legal warning.  
 Concerniente a las marcas y denominaciones comerciales ver aviso legal.  
 Marka eta izendapen komertzialiei dagokienez, ikus lege-oharra.  
 Concernant les marques et dénominations commerciales voir la note dans l'index.

**JMA** Opening the future

**JMA** Opening the future

Beziehen auf die marke und handelsname sehen sie die notiz im Impressum.  
 Relativamente às marcas e denominações comerciais, ver aviso legal.  
 Ješli chodzí o znaki i nazwy handlowe, patrz Informacje prawne.

FOR: HeFELE®			FOR: HAGA®	FOR: HAHN&KOLB®
HAF-2	HAF-2D	TA 100-999 HAF-3D	HAG-1D	HKO-1D
FOR: WSS®-WORTH®				
FOR: HALLE®	FOR: HARKOV®		FOR: HARLOC®	
HAL-1	HAK-1D	HAK-2D	HAK-3	HAK-4
	HAK-5			HAR-11
				FOR: DNS®-EAGLE®-LORI®
FOR: HAYWORTH®	FOR: HEKNA®		FOR: HELIX®	FOR: HENDERSON®
LAT. HAW-1D	....1001-1425 HEK-1	HEK-2	HEL-1	R 008-254 HEN-1
HAW-2D	HEK-2			HEN-1D
HAW-3D	HEK-3			
HAW-4D		HEK-6		
		HEK-5		
		....1501-1540 HEK-4 HEK-4D		
		FOR: METALCASTELLI® FOR: RAUCO®-REGENT®		FOR: REGENT®

FOR: HENDERSON®	FOR: HERME®	FOR: HFM®	FOR: HOBES®	
HEN-2	HRM-1	HF-1D	HOB-1	HOB-2D
FOR: HOK®	FOR: HORSE®	FOR: HTEC®	FOR: HTV®	
HOK-2D	HOR-1	HOR-2	HTE-1D	07 HT-1
FOR: MEGA®				FOR: VAUGHN®
FOR: HUDSON®	FOR: HUGO®	FOR: HUNIT®	FOR: HUWIL®	
HUD-2D	... 01-175 HUD-3	HUD-3D	HGO-1	HUN-1D
				FOR: FTH®
				W 3000-4000 A 3001-4000 HUW-1 HUW-1D
				FOR: STRAFOR®-STEELCASE®-WORTH®

Concerning the marks and commercial denominations see legal warning.  
 Concerniente a las marcas y denominaciones comerciales ver aviso legal.  
 Marka eta izendapen komertzialiei dagokienez, ikus lege-oharra.  
 Concernant les marques et dénominations commerciales voir la note dans l'index.



Beziehen auf die Marke und Handelsname sehen sie die Notiz im Impressum.  
 Relativamente às marcas e denominações comerciais, ver aviso legal.  
 Jeśli chodzi o znaki i nazwy handlowe, patrz Informacje prawne.





**FOR: HUWIL®**

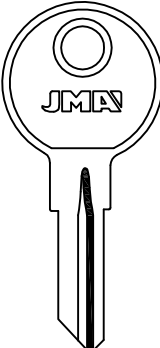

**HUW-2**

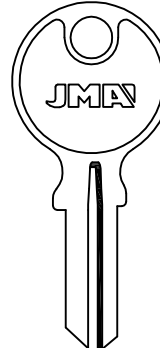

**HUW-N**

N  
0005-1878  
N  
2001-2204

**FOR: TECNO® - WÜRTH®**

**FOR: IBEAR®**

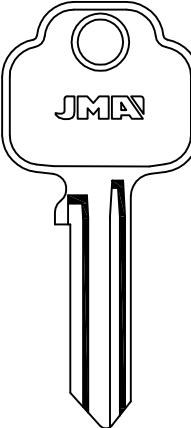

**IB-1**



**IB-2**

**FOR: ICA®**

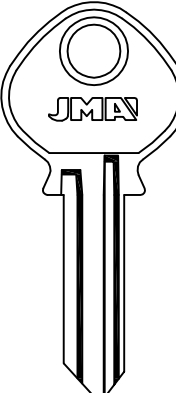

**ICA-1**

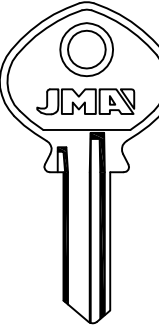

**ICA-4IP**

**FOR: ICA®**

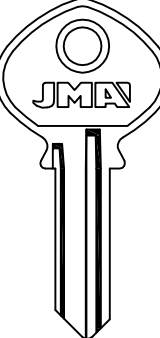

**ICA-5IP**

**FOR: ICSA®**

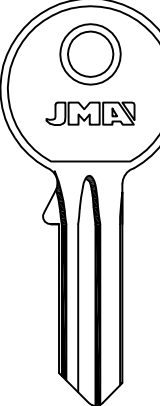

**ICS-1D**

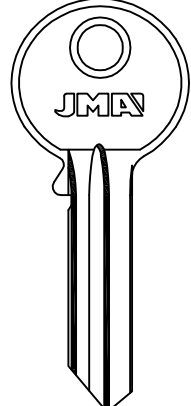

**ICS-2D**

**FOR: ORLANDO® - REMO® - ZANI®**

**FOR: IFAM®**

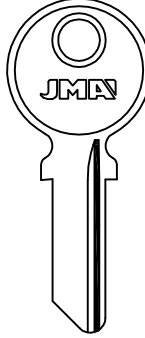

**IF-11**

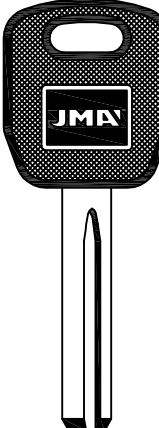

**IF-3.P**

**ALP.**

**FOR: JOMA®**

**FOR: IFAM®**

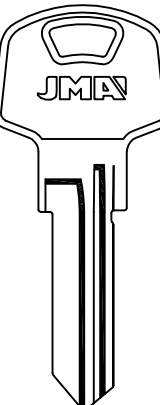

**IF-5**

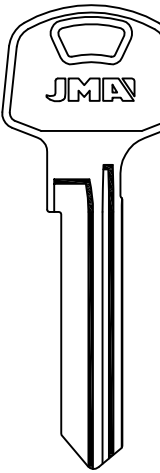

**IF-7**

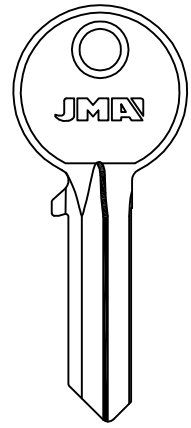

**IF-10D**

**F5S**

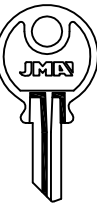

**IF-15**

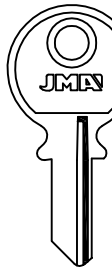

**IF-120**

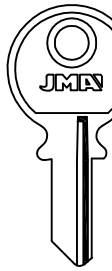

**IF-D20**

**FOR: TEM®**

**FOR: ABUS® - JOMA® - TEM® - TESLA®**

**FOR: IFAM®**

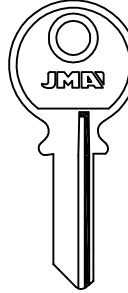

**IF-125**

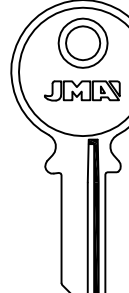

**IF-D25**



**IF-130**

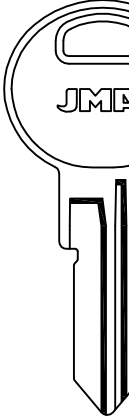

**IF-D30**

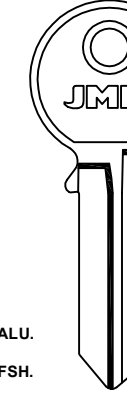

**IF-140**



**IF-35**



**IF-140L**



**IF-150**



**IF-45/55**

**ALU.\***

**\* ALU.**

**\* ALU.**

**\* FSH.**

**FOR: BATU® - FADE® - JOMA®**

**FOR: GUARD® - RIPA® - TEM®**

**FOR: JOMA®**

**FOR: RIPA®**

**FOR: RIPA®**

**FOR: IFAM®**

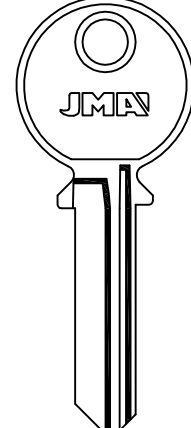

**IF-160/70**

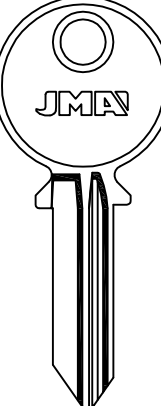

**IF-60/70**

**FOR: IGS®**



**IGS-1**

**FOR: IFAM®**

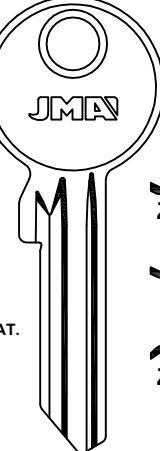

**IF-160/70**

**\* LAT.**

SN4  
ZE-1

SN3  
ZE-1D

SN2  
ZE-2

SN1  
ZE-2D

N2  
ZE-6

N1  
ZE-6D

M  
ZE-9D

SN5  
ZE-14D

**FOR: BRUMME® - OTIS®**

**FOR: IKON®**

1 AL 9 AL 0  
A-B-C-D-E-F-G-H-I-L

N2  
ZE-5I

N1  
ZE-5D

N1  
ZE-7D

**FOR: BRUMME® - OTIS®**

**FOR: IKON®**

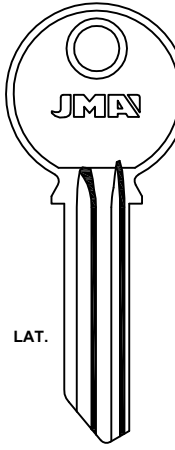

**ZE-8**

**LAT.**

ZE-40D	ZE-41	ZE-78D	ZE-79	ZE-86D	ZE-93D	ZE-100	ZE-120
ZE-38	ZE-39	ZE-76D	ZE-77D	ZE-85	ZE-92D	ZE-99	ZE-119D
ZE-36D	ZE-37D	ZE-74	ZE-75	ZE-84	ZE-91D	ZE-98	ZE-118
ZE-21D	ZE-22	ZE-72	ZE-73	ZE-83	ZE-90	ZE-97D	ZE-104D
ZE-19	ZE-20	ZE-46	ZE-71D	ZE-82	ZE-89	ZE-96D	ZE-103
ZE-17D	ZE-18D	ZE-44D	ZE-45D	ZE-81	ZE-88	ZE-95D	ZE-102
ZE-15	ZE-16D	ZE-42	ZE-43	ZE-80	ZE-87	ZE-94D	ZE-101

Concerning the marks and commercial denominations see legal warning.  
 Concerniente a las marcas y denominaciones comerciales ver aviso legal.  
 Marka eta izendapen komertzialak dagokienez, ikus lege-oharra.  
 Concernant les marques et dénominations commerciales voir la note dans l'index.

**JMA®** Opening the future

**JMA®** Opening the future

Beziehen auf die Marke und Handelsname sehen Sie die Notiz im Impressum.  
 Relativamente às marcas e denominações comerciais, ver aviso legal.  
 Jeśli chodzi o znaki i nazwy handlowe, patrz Informacje prawne.

FOR: IKON®

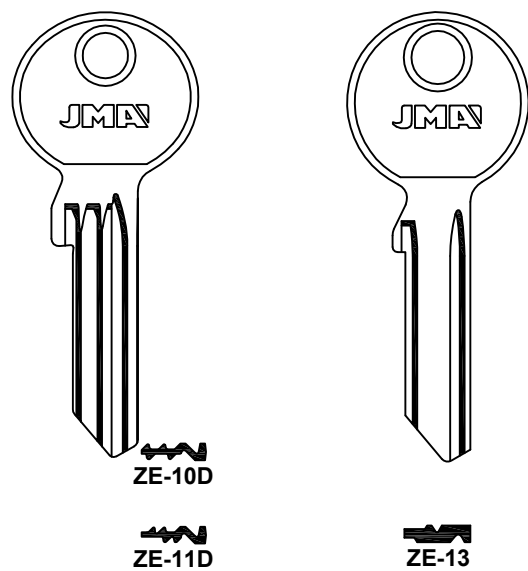
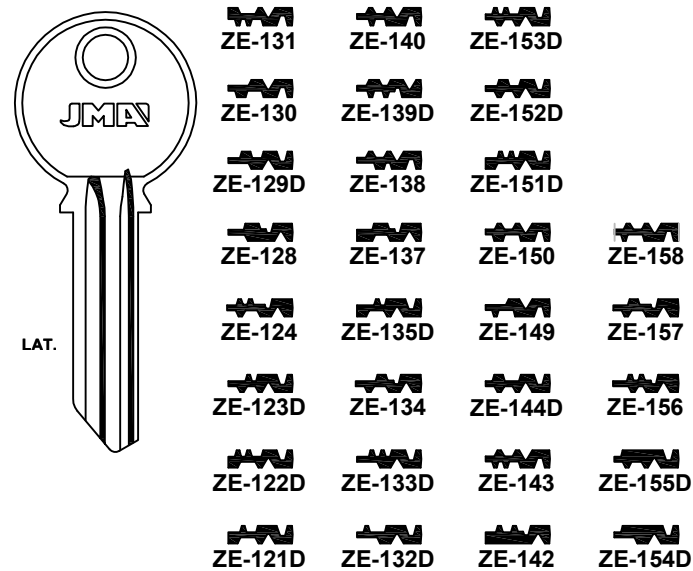

FOR: IKON®

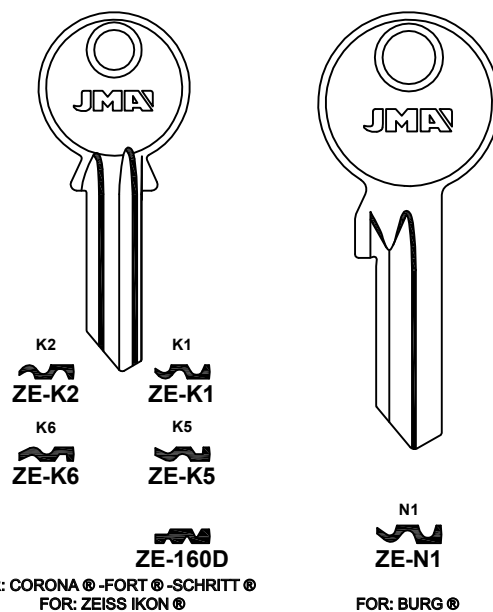

FOR: ILARGI®

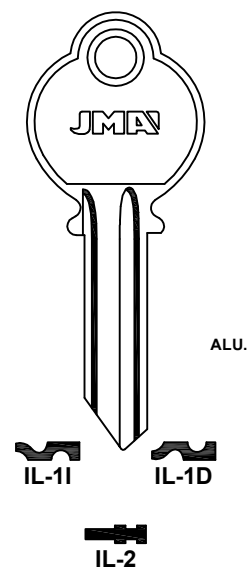

FOR: ILCO®

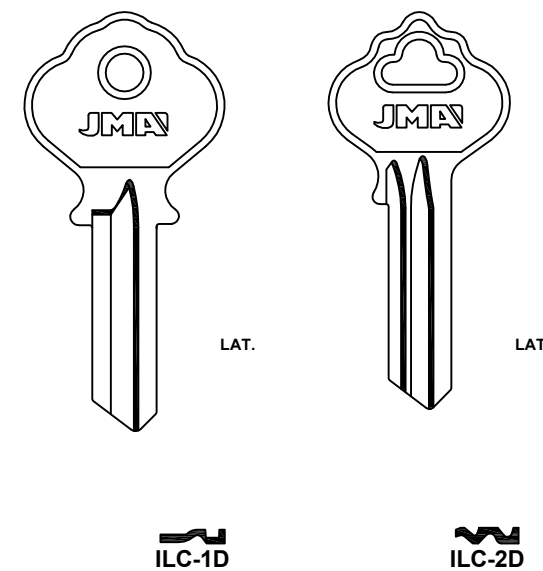

FOR: IKON®

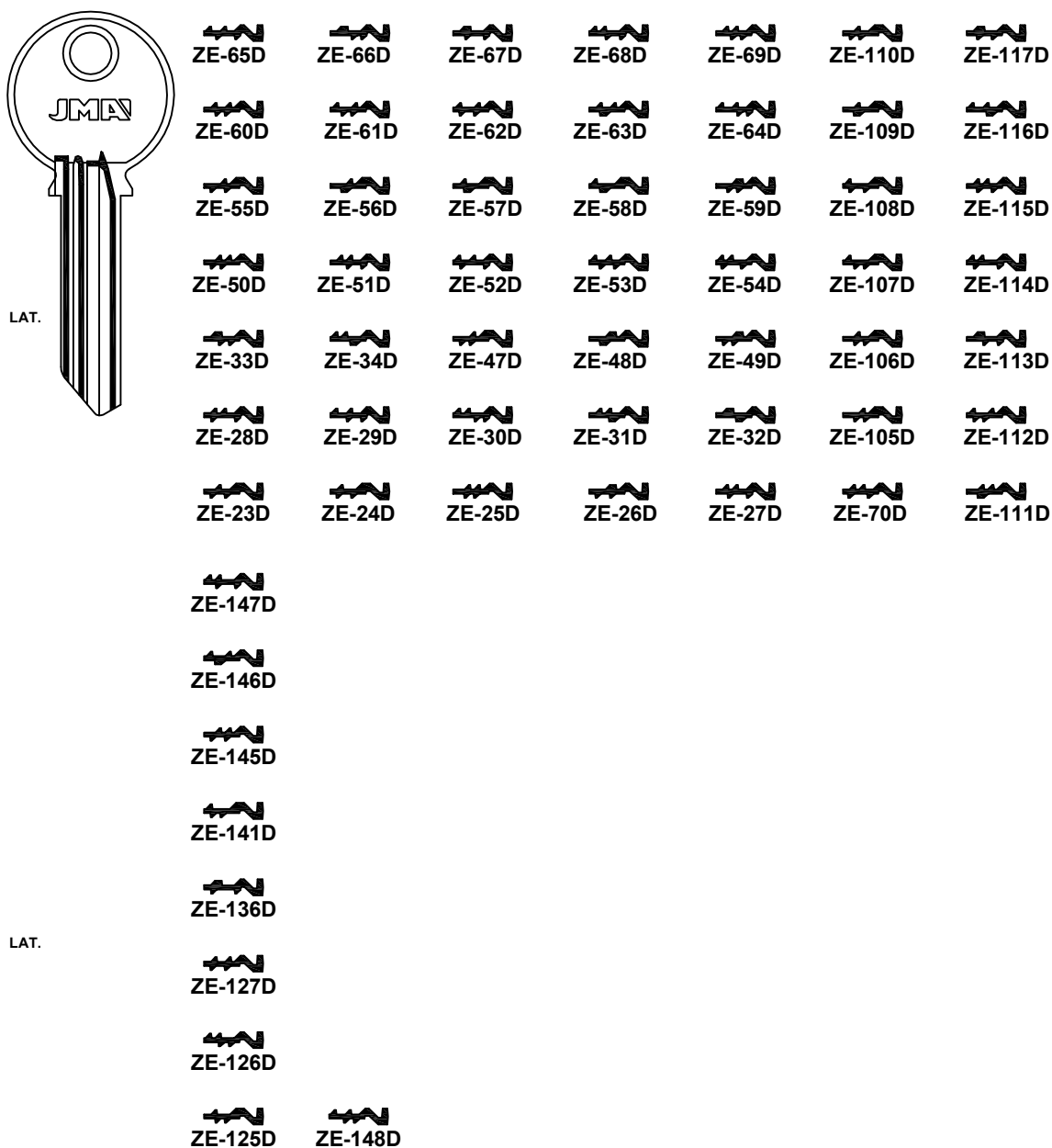

FOR: IKON®

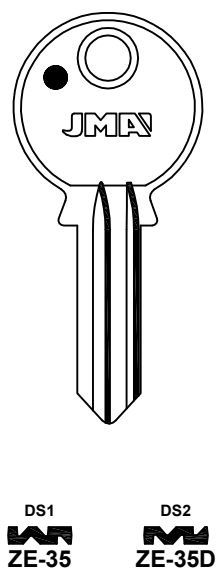

FOR: IKON®

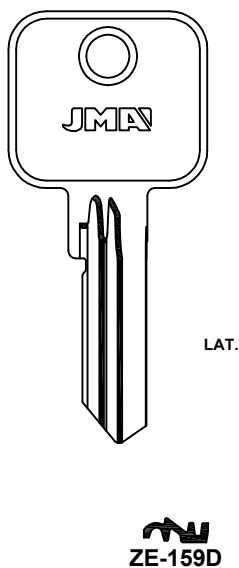

PERFIL Z SERIE 400

FOR: ILCO®

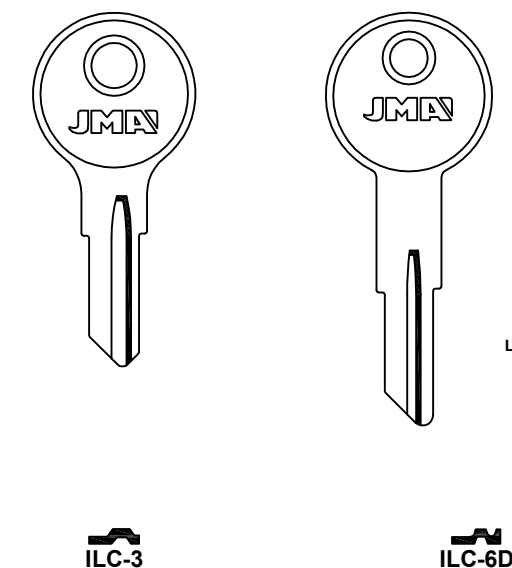

FOR: ILLINOIS®

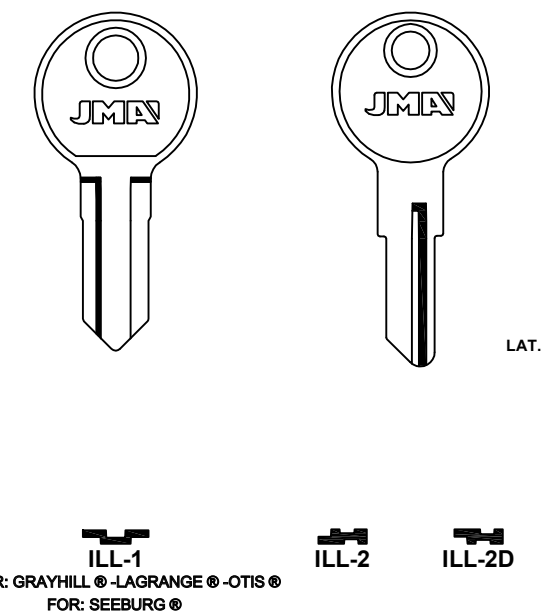

FOR: ILS®

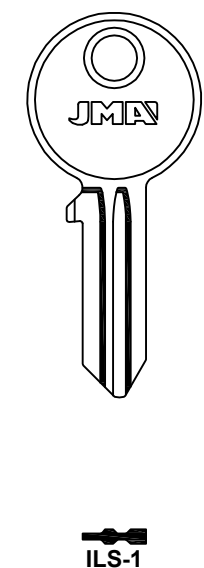

FOR: IMB®

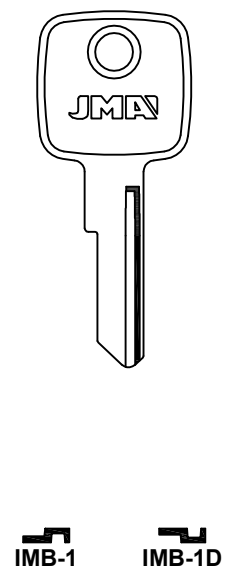

FOR: INGERSOLL®

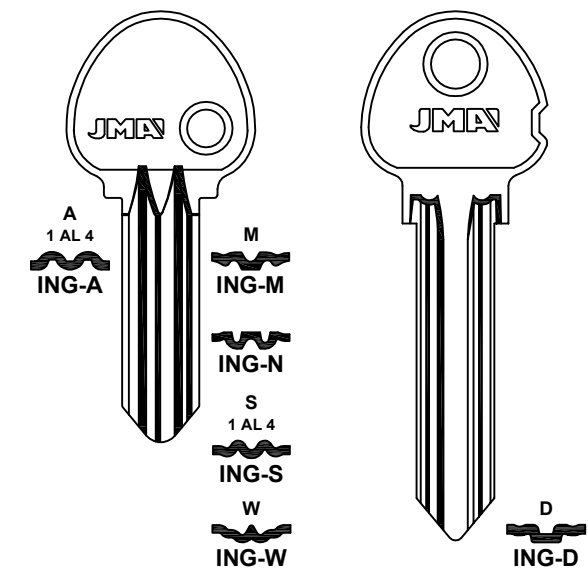

FOR: INT®

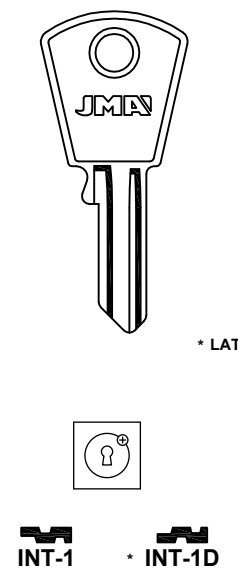

Concerning the marks and commercial denominations see legal warning.  
 Concerniente a las marcas y denominaciones comerciales ver aviso legal.  
 Marka eta izendapen komertzialiei dagokienez, ikus lege-oharra.  
 Concernant les marques et denominations commerciales voir la note dans l'index.

**JMA**® Opening the future

**JMA**® Opening the future

Beziehen auf die marke und handelsname sehen sie die notiz im Impressum.  
 Relativamente às marcas e denominações comerciais, ver aviso legal.  
 Jeśli chodzi o znaki i nazwy handlowe, patrz Informacje prawne.

FOR: ISEO®

ALU. • ALU. • WColor

WColor

1 AL 5  
IS-11 IS-1D

....1-2000  
Y....1-2000  
0 AL 8  
IS-21 IS-2D

IS-31 IS-3D

F5  
IS-3D

FOR: TESA®

FOR: ISEO®

F3 IS-15

IS-16D

F6  
VBE.....000001-014970  
A/Z A/Z A/Z.....1-48568  
IS-17D

IS-21D

FOR: ISEO SILVER®

FOR: IVANA®

IV-1

IV-2D

IV-3D

FOR: ISUZU®

LAT.

ISU-5

FOR: ITO®

ITO-1D

FOR: JARDI®

JAR-11 JAR-1D

JAR-21 JAR-2D

JAR-3 JAR-6 JAR-6D

FOR: JARDI®

JAR-4D JAR-5I JAR-5D

FOR: JINLONG®

JIN-1D

FOR: JIP®

JIP-11 JIP-1D

FOR: JIS®

ALU. FSH. JIS-1D

FOR: JIS®

ALU. ALP.

JIS-21 JIS-31 JIS-3D JIS-4.P

FOR: SEMEL®

FOR: JOMA®

JOM-1D

FOR: JOVI®

JO-1

FOR: JOWIL®

FOR:  
ESZ®  
FHUR®  
GTV®  
JÜNGST®  
MERCUR®  
OSKO®  
PANTHER®  
TIEFENTHAL®  
TRITON®  
VOKO®  
WEPA®

JWL-1D JWL-3D JWL-4D JWL-9 JWL-9D JWL-2D JWL-5 JWL-6 JWL-7D

FOR: GTV®

Concerning the marks and commercial denominations see legal warning.  
 Concerniente a las marcas y denominaciones comerciales ver aviso legal.  
 Marka eta izendapen komertzialiei dagokienez, ikus lege-oharra.  
 Concernant les marques et dénominations commerciales voir la note dans l'index.

**JMA®** Opening the future

**JMA®** Opening the future

Beziehen auf die Marke und Handelsname sehen Sie die Notiz im Impressum.  
 Relativamente às marcas e denominações comerciais, ver aviso legal.  
 Jeśli chodzi o znaki i nazwy handlowe, patrz Informacje prawne.



FOR: JOWIL®	FOR: JPM®			
  LAT.	  	  	  	  
	FOR: ABUS®			

FOR: JPM®	FOR: JTF®			FOR: JU-JUNGINGER®
  BT  BK 	   	   	   	   D  A  B  C 

FOR: JUNGHEINRICH®	FOR: JUNIE®			FOR: JUNKUNC®
	    	     	     	 1 AL 8 
	FOR: PEROHAUS® -US®			FOR: A.MOTORS® -BULIT® -LION®

FOR: JUNKUNC®	FOR: JUZU®	FOR: JVAL®		FOR: KABS®
  1 AL 8  		  	    	  
FOR: ALSO® -A.MOTORS® -BULIT® -LION®		FOR: P.C.® -FEB®		FOR: P.C.® -FEB®

FOR: KALE®				
FOR: FAC® -GAON® -AMIG® -TURSAN®				

FOR: KALUGA®	FOR: KAP®	FOR: KAZAN®		
 	  X  C 		 KN 	

Concerning the marks and commercial denominations see legal warning.  
 Concerniente a las marcas y denominaciones comerciales ver aviso legal.  
 Marka eta izendapen komertzialiei dagokienez, ikus lege-oharra.  
 Concernant les marques et dénominations commerciales voir la note dans l'index.

**JMA®** Opening the future

**JMA®** Opening the future

Beziehen auf die Marke und Handelsname sehen sie die Notiz im Impressum.  
 Relativamente às marcas e denominações comerciais, ver aviso legal.  
 Jeśli chodzi o znaki i nazwy handlowe, patrz Informacje prawne.

FOR: KAZAN®



KAZ-4 KAZ-5 KAZ-5D KAZ-6 KAZ-7

FOR: KENWORTH®

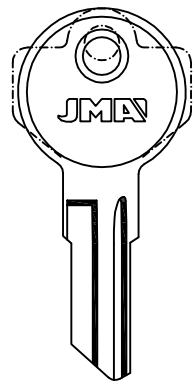

C....  
250-499  
1701-1950  
KEN-1 KEN-1D

FOR: BASCO®-BRIGGS&STRATTON®-YALE®

FOR: KREMENCHUG®

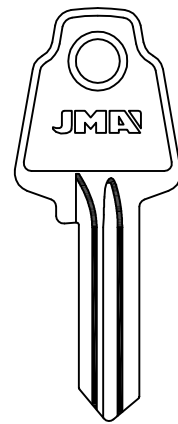

KRE-1D

FOR: KWIKSET®

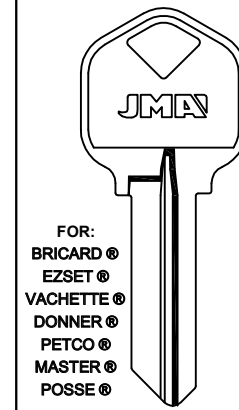

FOR:  
BRICARD®  
EZSET®  
VACHETTE®  
DONNER®  
PETCO®  
MASTER®  
POSSE®

1 AL 7  
KWI-1

FOR: BRICARD®-EZSET®-VACHETTE®

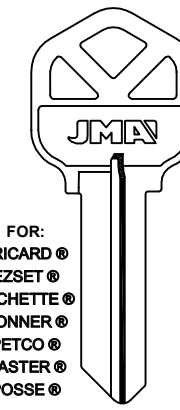

FOR:  
BRICARD®  
EZSET®  
VACHETTE®  
DONNER®  
PETCO®  
MASTER®  
POSSE®

1 AL 7  
KWI-1K

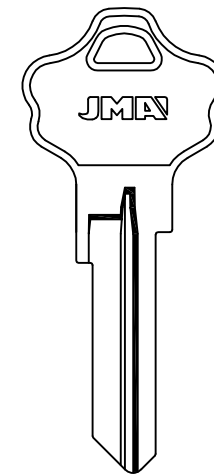

KWI-2D

FOR: TITAN®

LAT.

FOR: KYNNARPS®

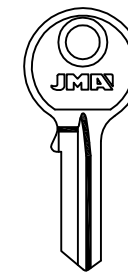

KNA-1D

FOR: KJV®

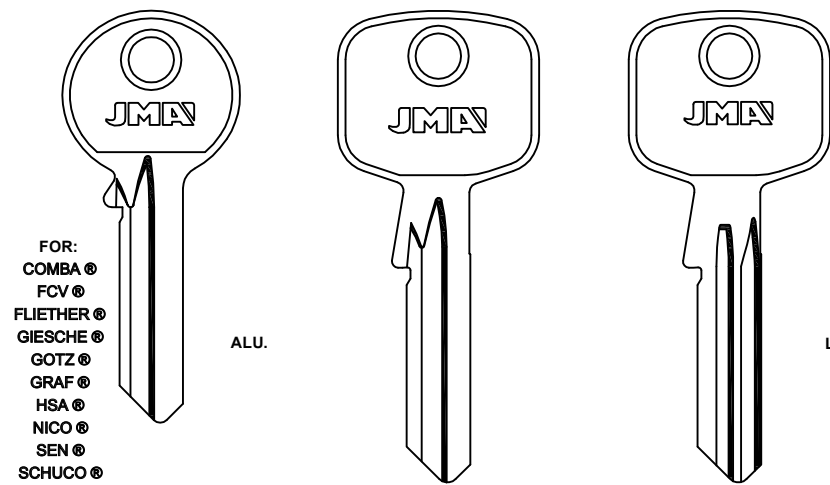

FOR:  
COMBA®  
FCV®  
FLIETHER®  
GIESCHE®  
GOTZ®  
GRAF®  
HSA®  
NICO®  
SEN®  
SCHUCO®

ALU.

LAT.

KJV-1 KJV-2 KJV-3

FOR: COMBA®-FCV®-FLIETHER®-GIESCHE®  
FOR: GOTZ®-GRAF®-HSA®-NICO®-SCHUCO®-SEN®

FOR: KICHINEV®

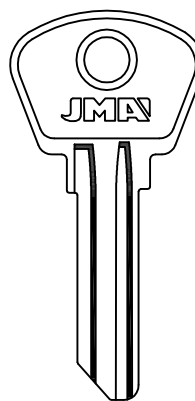

KIC-1

- KJV-O
- KJV-N
- KJV-M
- KJV-L
- KJV-F
- KJV-E
- KJV-D
- KJV-C

FOR: LAFONTE®

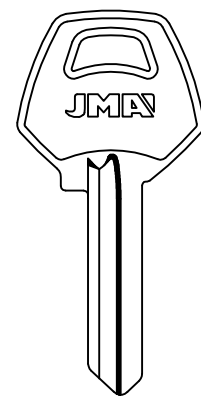

LAF-1D

FOR: LAPERCHE®

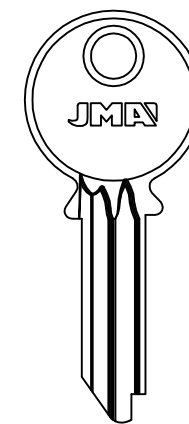

DM  
LAP-1

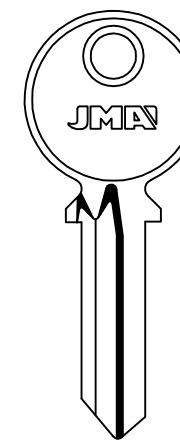

LAP-2D

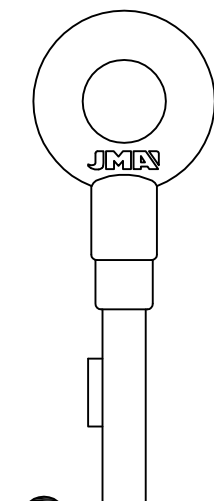

LAP-2E

LAT.

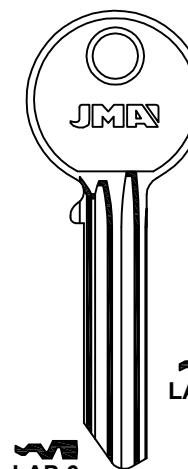

LAP-3D

LAX  
LAP-7D

LAP-6

LAP-3I

LAP  
LAP-3D

FOR: GEMM®-RONIS®

FOR: KIFERM®

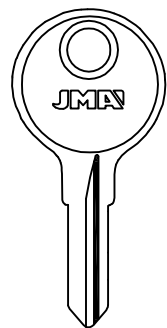

KIF-1

FOR: KIROVMACH®

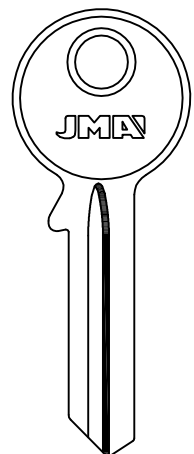

KIR-1D

FOR: KP®

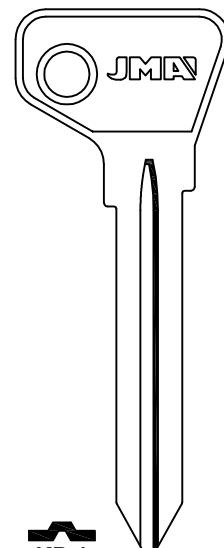

KP-1

FOR: KRAMATORSK®

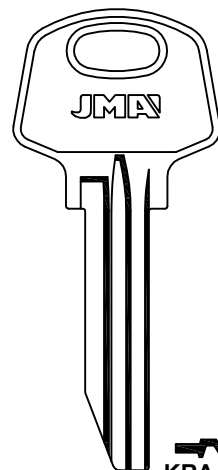

KRA-1D

KRA-2

FOR: LAPERCHE®

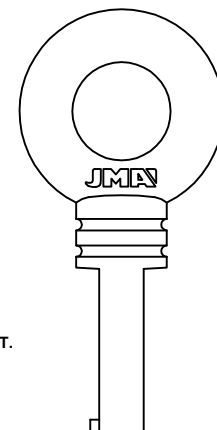

LAT.

LAP-3E

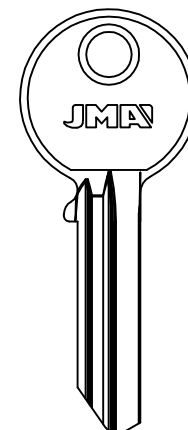

LAP-5D

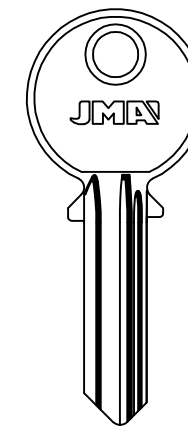

LAP-9

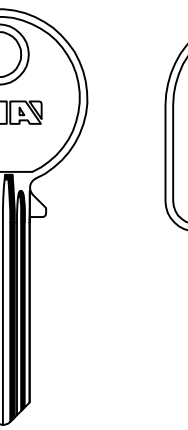

LAP-9D

FOR: GEMM®-RONIS®

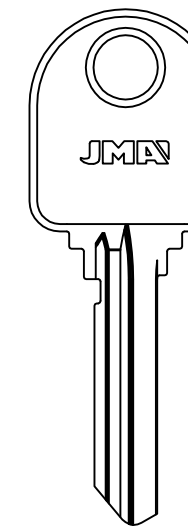

S  
LAP-28D

LAT  
LAP-29D

LAV  
LAP-30D

LAR  
LAP-34D

FOR: GEMM®-RONIS®

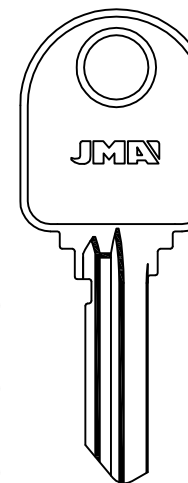

S  
LAP-42D

X  
LAP-43D

T  
LAP-44D

V  
LAP-45D

R  
LAP-46D

FOR: GEMM®-RONIS®

Concerning the marks and commercial denominations see legal warning.  
Concerniente a las marcas y denominaciones comerciales ver aviso legal.  
Marka eta izendapen komertzialiei dagokienez, ikus lege-oharra.  
Concernant les marques et dénominations commerciales voir la note dans l'index.

FOR: LAPERCHE®

- ADA  
LAP-53
- BEA  
LAP-57
- ADD  
LAP-71
- BDC  
LAP-88
- AEB  
LAP-93
- BFB  
LAP-98

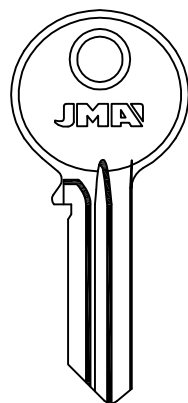
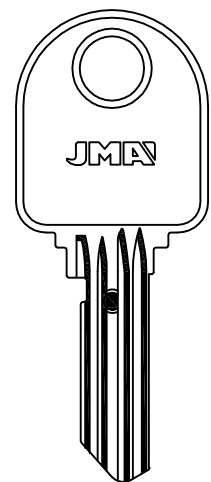

LAP-96D

FOR: VACHETTE®

FOR: LAPORTE®

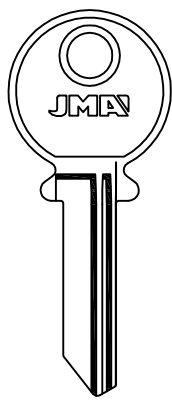

LPO-1

FOR: LAPORTE®

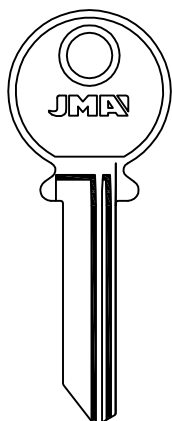

LPO-2

FOR: LAPORTE®

FOR: LAS®

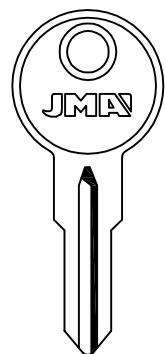

AX  
001-224  
LAS-AX/L

FOR: ATAL® - HEFELE® - KIFERM® - RENZ® FOR: DUBOIS® - KIFERM® - PJ® - PK® FOR: ATAL® - JU® - KIFERM® - METEOR® - RENZ®

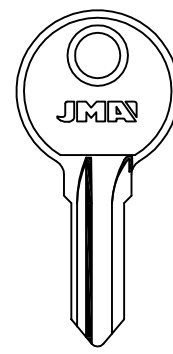

R  
001-224  
LAS-R

FOR: LAS®

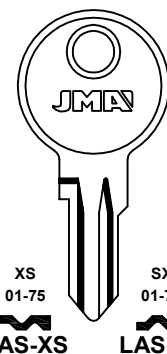

XS  
01-75  
LAS-XS

FOR: LAS®

FOR: LASBOLAGET®

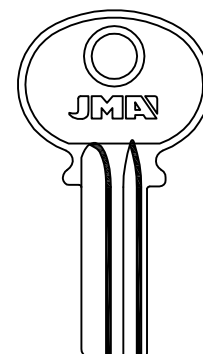

LASB-1

LASB-2

LASB-3D

FOR: LASBOLAGET®

FOR: LEGALLAIS®

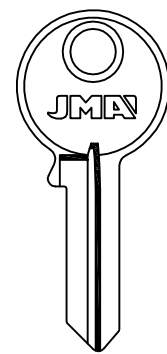

LEA-1D

FOR: LEGALLAIS®

FOR: LARK®

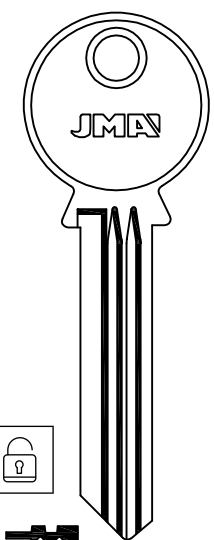

LAR-11

FOR: LARK®

FOR: LAS®

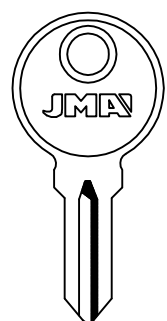

AX  
001-224  
LAS-AX

EX  
LAS-1D

FOR: ATAL® - HEFELE® - KIFERM® - RENZ®

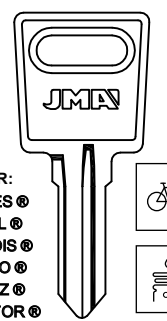

FOR: ABBES®  
ATAL®  
DUBOIS®  
ORDO®  
RENZ®  
STRAFOR®  
RONIS®

FM  
LAS-2

FM  
001-400  
501-550  
LAS-4

LAS-4D

FOR: LAS®

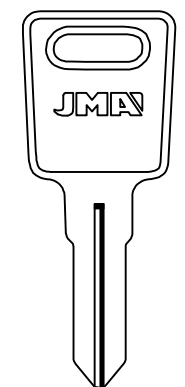

\* LAT.

LS  
LAS-8

L  
LAS-9

FOR: ABBES® - ORDO®

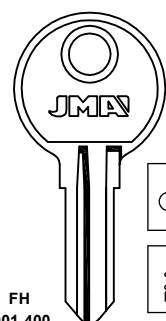

FH  
001-400  
501-550  
LAS-3

H  
LAS-5

U  
LAS-U

FOR: KIFERM®

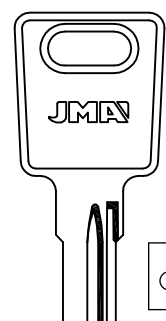

TA  
LAS-6

RM  
0001-2000  
KT  
3001-4000  
LAS-KT

TK  
4001-5000  
LAS-TK

FOR: RONIS® - EURO LOCKS®  
FOR: ATAL® - KIFERM® - MARCADET®

FOR: LAS®

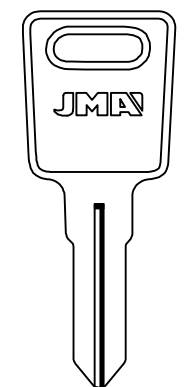

PR  
LAS-10

FOR: MARCADET®

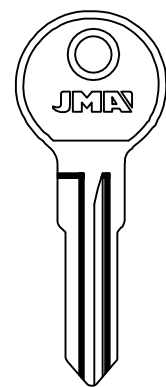

A...1-650  
LAS-11D

FOR: ATAL® - KIFERM® - RENZ®

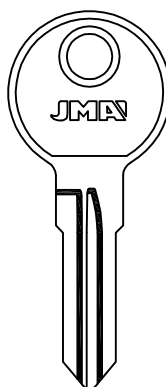

LAS-12D

FOR: ATAL® - KIFERM® - RENZ®

FOR: LAS®

V  
001-224  
LAS-V

Y  
001-224  
LAS-Y

SX  
01-75  
LAS-SX

TX  
01-75  
LAS-TX

XY  
01-75  
LAS-XY

FOR: LEGALLAIS®

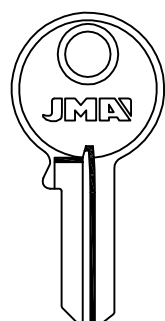

LEA-2D

FOR: LEGALLAIS®

FOR: LEGGE®

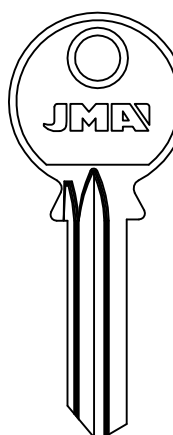

1 AL 7  
LEG-1D

FOR: LEGGE®

FOR: LINCE®

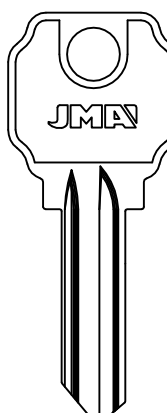

A  
LIN-11

FOR: LINCE®

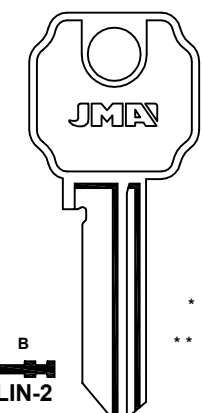

B  
LIN-2

C  
LIN-3I

R  
LIN-15I

FOR: LINCE®

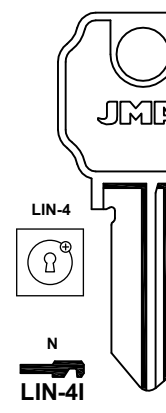

N  
LIN-4I

C  
LIN-3D

R  
LIN-15D

FOR: LINCE®

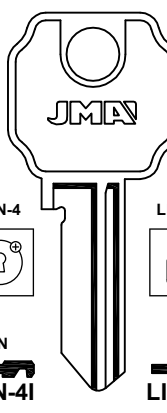

N  
LIN-14I

C  
LIN-14D

U (A)  
LIN-20D

FOR: LINCE®

FOR: LINCE®

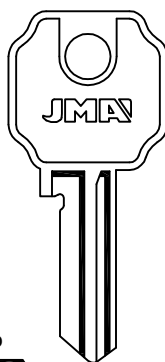

D  
LIN-5I

T  
LIN-12I

D1  
LIN-18

FOR: LINCE®

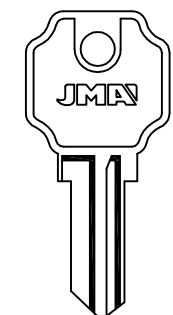

D  
LIN-5D

T  
LIN-12D

D1  
LIN-18D

FOR: LINCE®

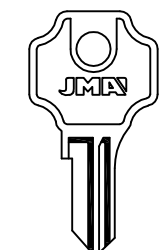

E  
LIN-6I

E  
LIN-6D

FOR: LINCE®

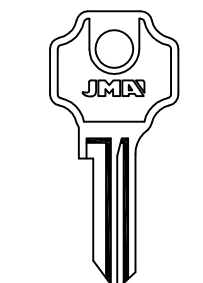

F  
LIN-7I

FOR: LINCE®

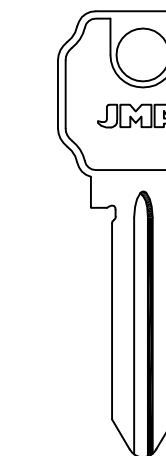

J  
LIN-8I

FOR: LINCE®

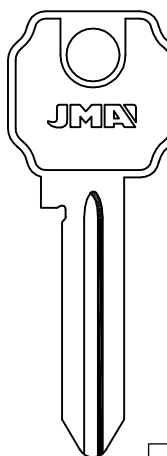

K  
LIN-9

FOR: LINCE®

Concerning the marks and commercial denominations see legal warning.  
Concerniente a las marcas y denominaciones comerciales ver aviso legal.  
Marka eta izendapen komertzialiei dagokienez, ikus lege-oharra.  
Concernant les marques et denominations commerciales voir la note dans l'index.

**JMA** Opening the future

**JMA** Opening the future

Beziehen auf die marke und handelsname sehen sie die notiz im Impressum.  
Relativamente às marcas e denominações comerciais, ver aviso legal.  
Jeśli chodzi o znaki i nazwy handlowe, patrz Informacje prawne.

**JMA** Opening the future K01 / 69



FOR: LINCE®

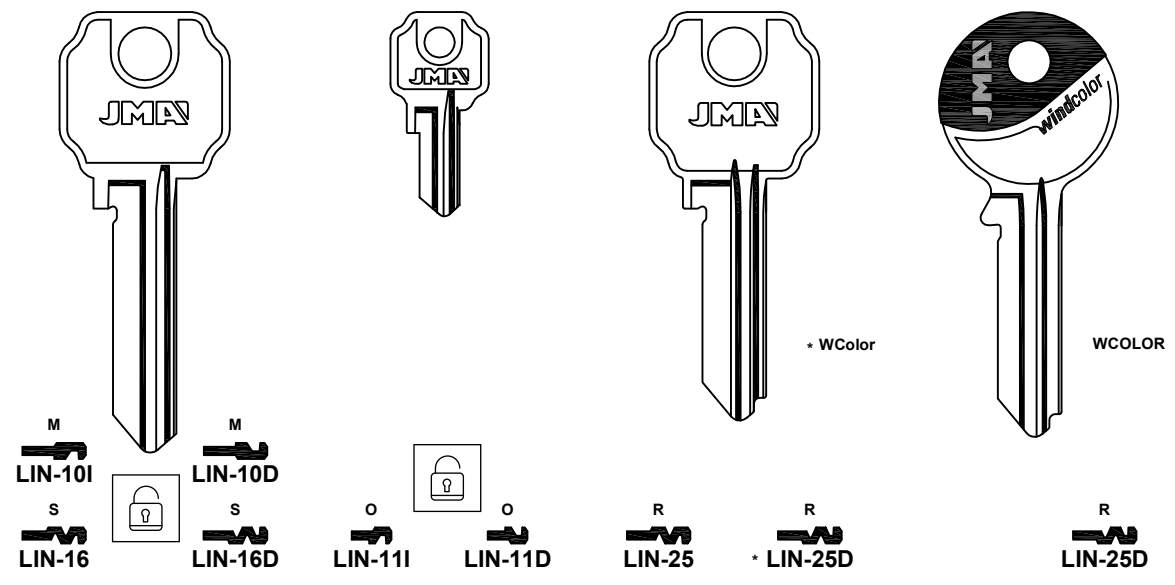

FOR: LIPS®

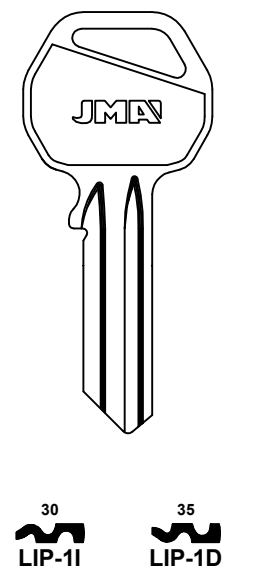

FOR: LOB®

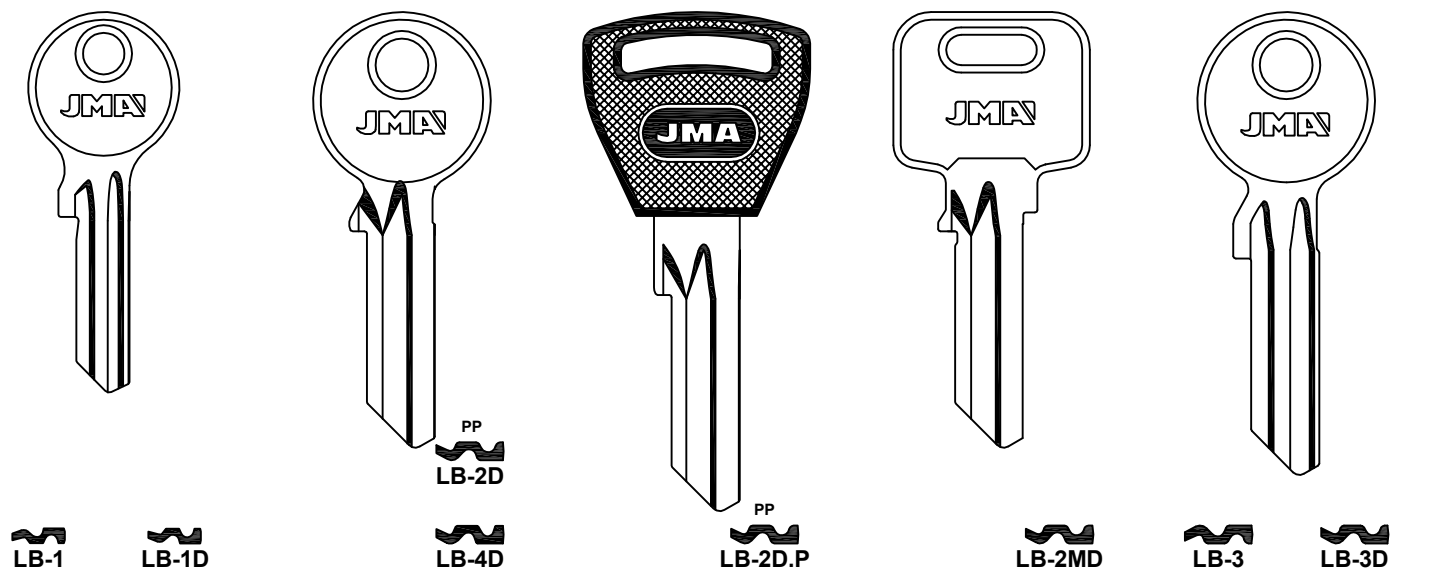

FOR: LIPS®

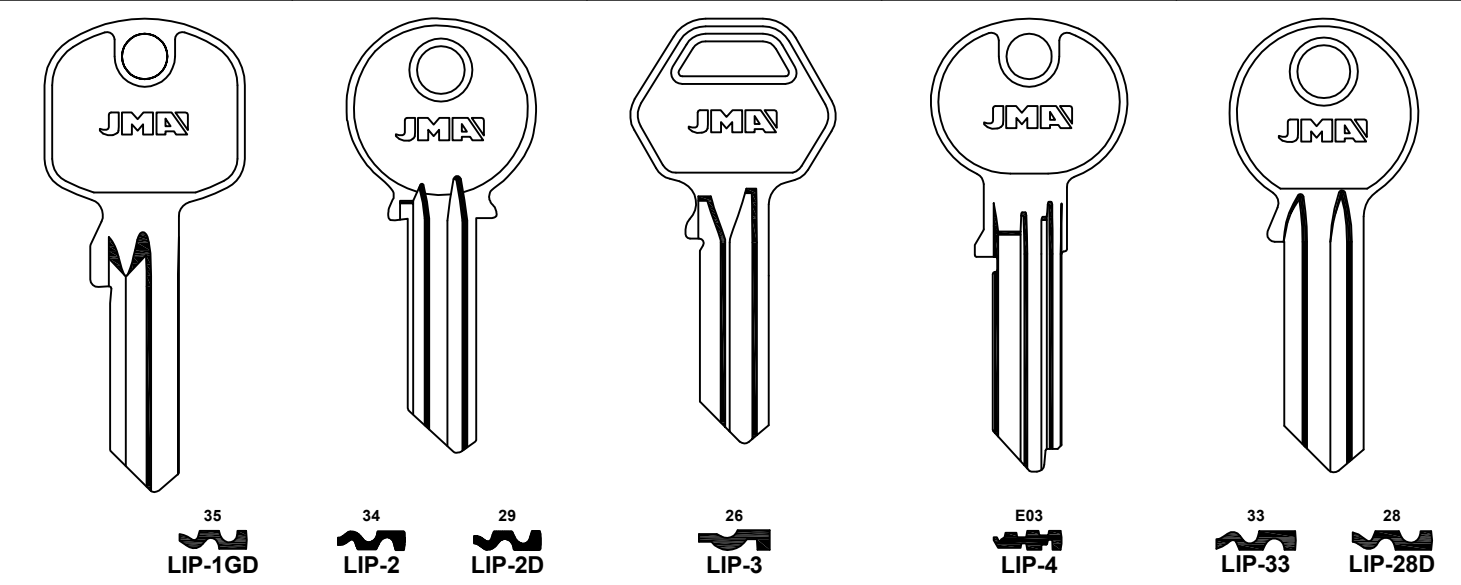

FOR: LOB®

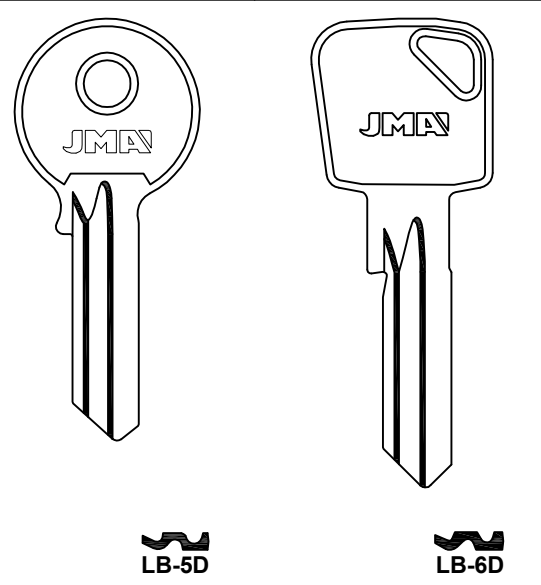

FOR: LOCK®

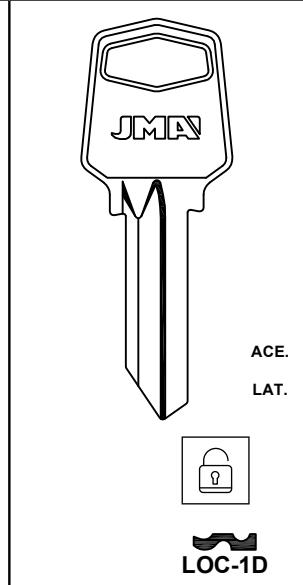

FOR: LOCKWOOD®

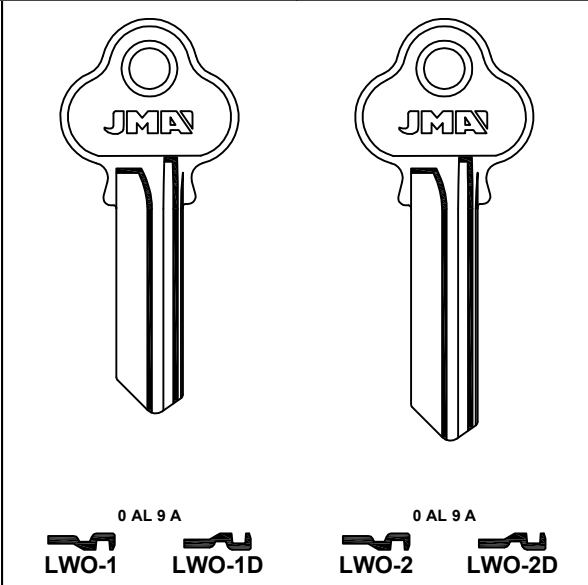

FOR: LITTO®

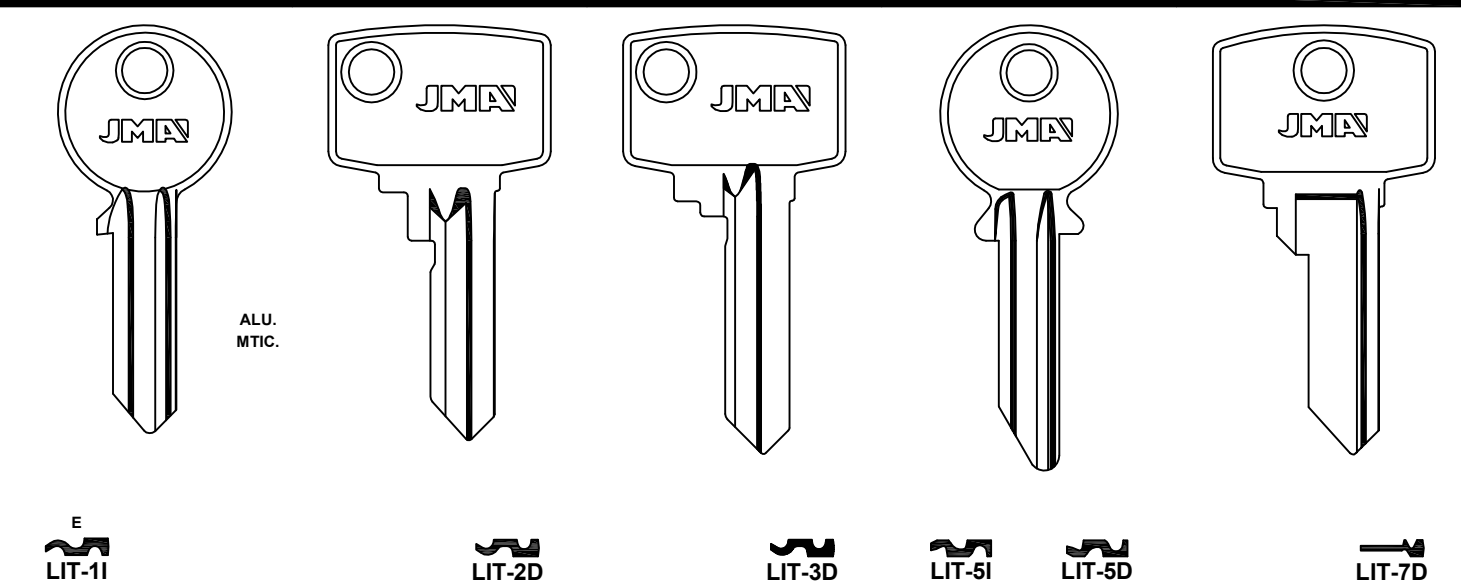

FOR: LOCKWOOD®

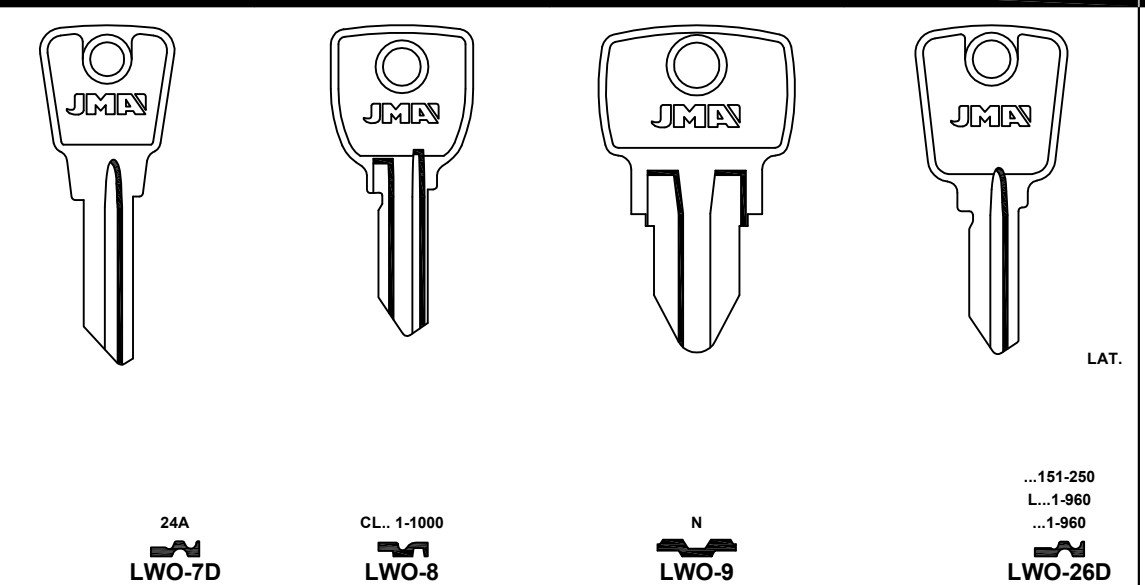

FOR: LOGO®

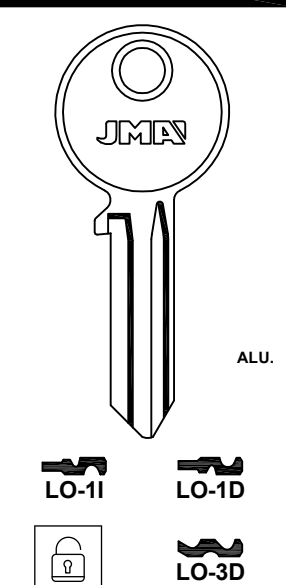

Concerning the marks and commercial denominations see legal warning.  
 Concerniente a las marcas y denominaciones comerciales ver aviso legal.  
 Marka eta izendapen komertzialiei dagokienez, ikus lege-oharra.  
 Concernant les marques et dénominations commerciales voir la note dans l'index.

**JMA** Opening the future

**JMA** Opening the future

Beziehen auf die marke und handelsname sehen sie die notiz im Impressum.  
 Relativamente às marcas e denominações comerciais, ver aviso legal.  
 Jeśli chodzi o znaki i nazwy handlowe, patrz Informacje prawne.

**K01** / 71

FOR: LOGO ®

FOR: LOWE & FLETCHER ®

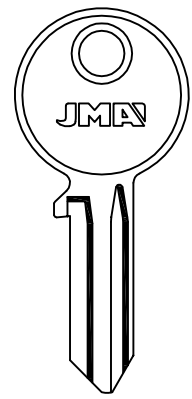

LO-21 LO-2D



FOR: CISA ®

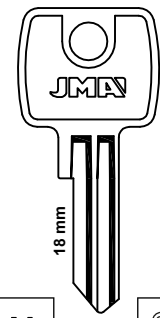

90...1-200  
...1-400  
91...201-275  
GH...1-4000  
SS...1-400  
91...276-350



LF-11 LF-1D

FOR: CEM ® -EURO LOCKS ® -UNION ®

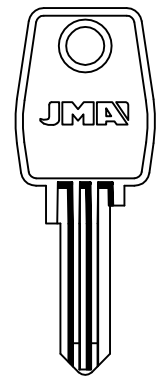

95001-97000  
97001-99000



LF-2



LF-12 LF-12D

FOR: DOBLE SAFE ® -EURO LOCKS ®

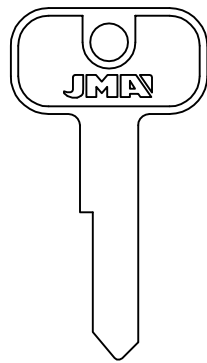

RL-RM  
801-952



LF-3

FOR: STREBOR ®

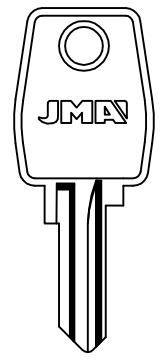

LF-4I

FOR: EURO LOCKS ®

FOR: LOWE & FLETCHER ®

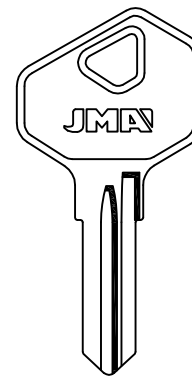

19...1-420  
...17001-19000  
...7001-9000



LF-20

FOR: B&D ® -BRIGGS & STRATTON ®

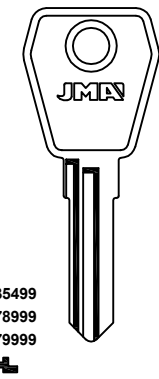

...35000-35499  
...78000-78999  
...79000-79999



LF-21

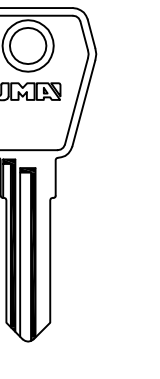

LF-33D

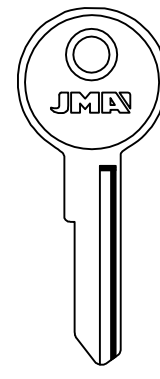

LF-22

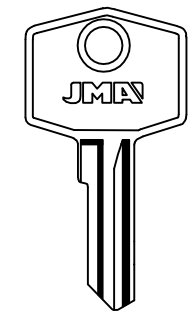

LF-23

FOR: ULTRA ®

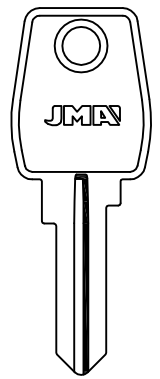

LF-24

FOR: DOBLE SAFE ® -EURO LOCKS ®

FOR: LOWE & FLETCHER ®

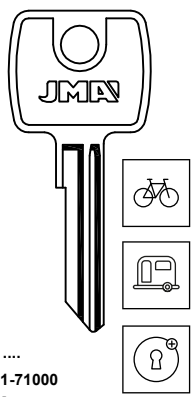

70001-71000  
M...  
70001-71000



LF-5 LF-5D

FOR: TELFORD ®

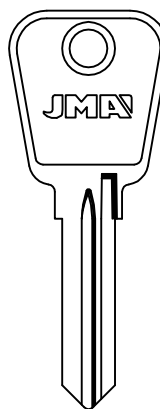

66001-67200 81001-87000



LF-7 LF-7D

FOR: FORD EUROPA ®

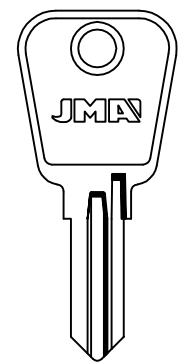

93...201-400  
...93901-94000



LF-8 LF-8D

FOR: EURO LOCKS ® -MIBRA ® -UTZ ®

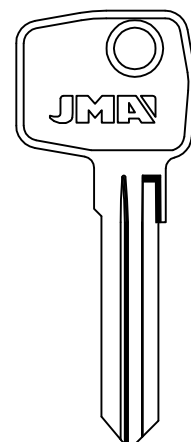

93...201-400  
...93901-94000

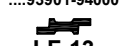

LF-13 LF-13D

FOR: MIBRA ® -UTZ ®

FOR: LOWE & FLETCHER ®

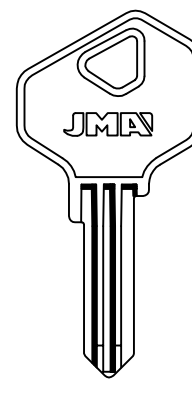

V..1-88



LF-25

14001-14088



LF-40

FOR: EURO LOCKS ®

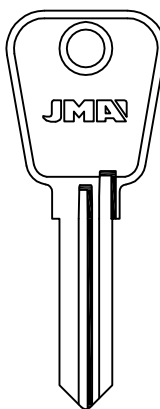

LF-26

FOR: EURO LOCKS ®

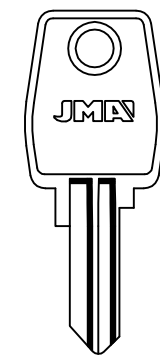

LF-27

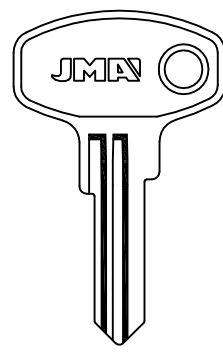

LF-28

FOR: EURO LOCKS ®

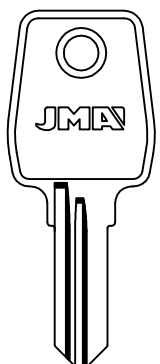

93...401-900  
...90901-90975

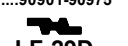

LF-29D

FOR: EURO LOCKS ®

FOR: LOWE & FLETCHER ®

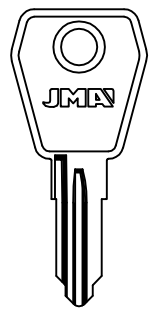

LF-14D

FOR: EURO LOCKS ®

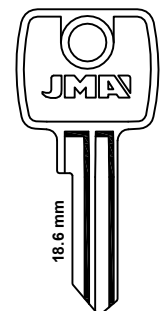

60... 001-200  
60... 001-200  
90... 001-200  
...1-400  
GHM...1-155  
M...1-400  
RV...1-400  
RVM...1-400  
SP...1-400  
99...1-400



LF-15

FFE  
001-100



LF-17

FOR: CEM ® -EURO LOCKS ® -ULTRA ® -UNION ®

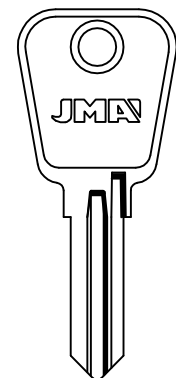
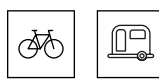

LF-16

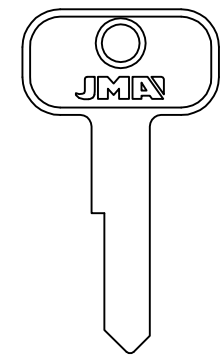

LF-18D

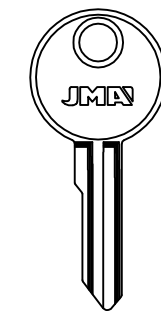

LF-19

FOR: LOWE & FLETCHER ®

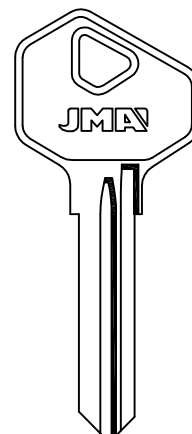

09...1-900  
29...1-478



LF-30

FOR: EURO LOCKS ®

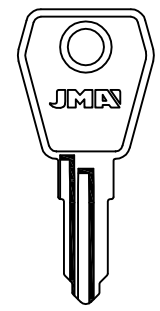

LF-31

FOR: EURO LOCKS ®

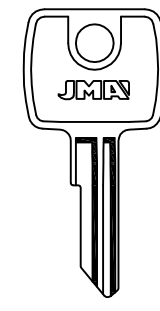

LF-34

FOR: EURO LOCKS ®

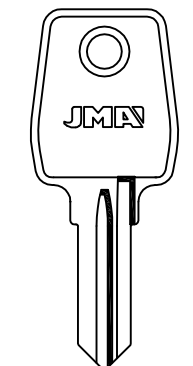

R...201-600  
...9001-9494



LF-35

FOR: EURO LOCKS ®

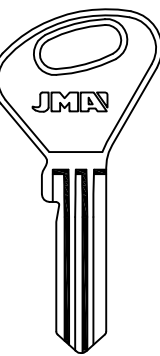

LF-36

FOR: EURO LOCKS ®

Concerning the marks and commercial denominations see legal warning.  
Concarniente a las marcas y denominaciones comerciales ver aviso legal.  
Marka eta izendapen komertzialiei dagokienez, ikus lege-oharra.  
Concernant les marques et denominations commerciales voir la note dans l'index.

FOR: LOWE & FLETCHER®

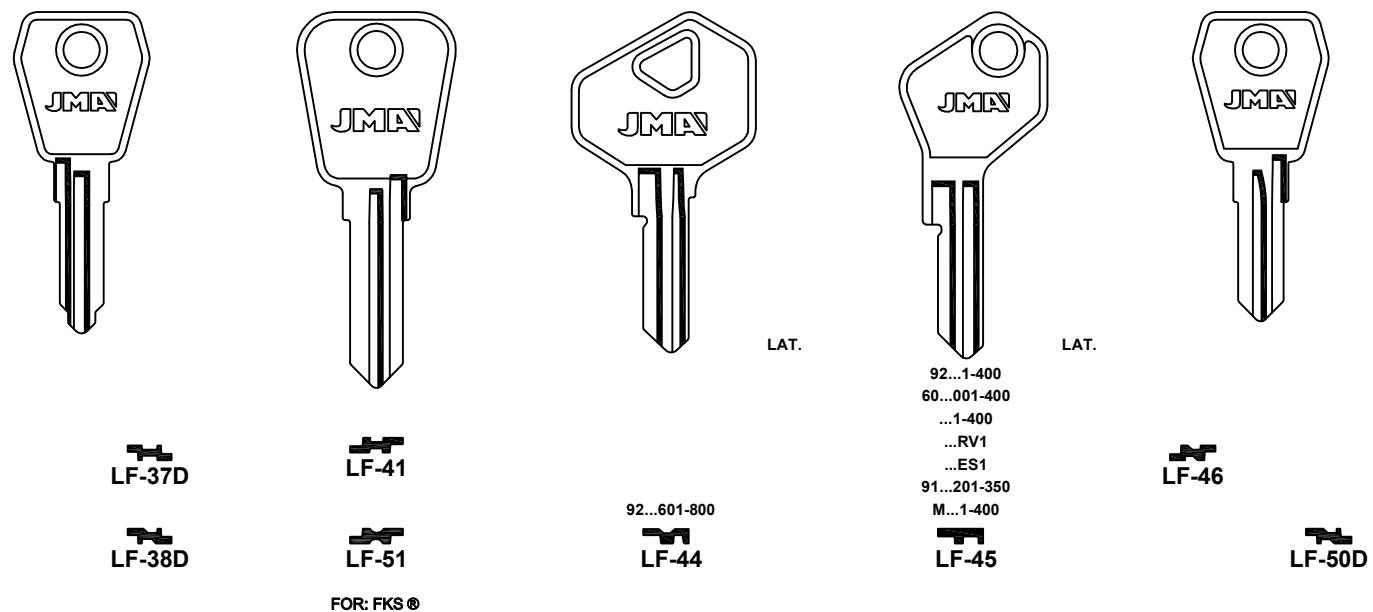

FOR: MASTER®

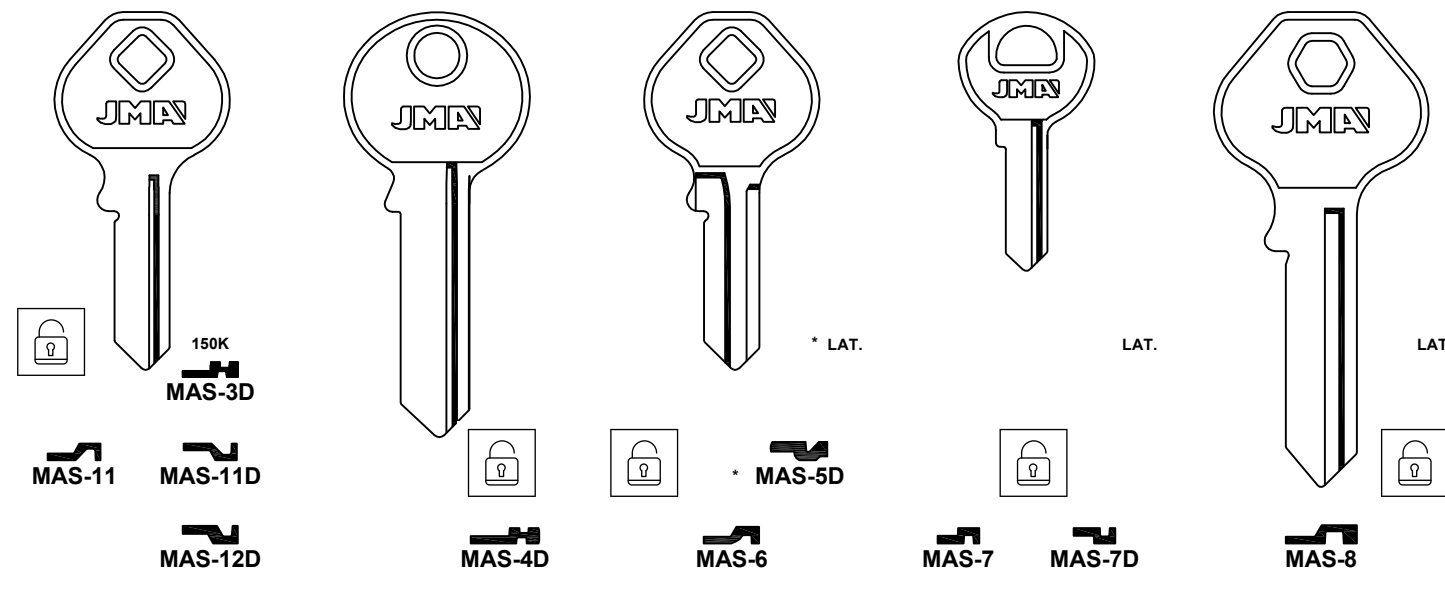

FOR: LUCKY®

FOR: LUMA®

FOR: MARIANI®

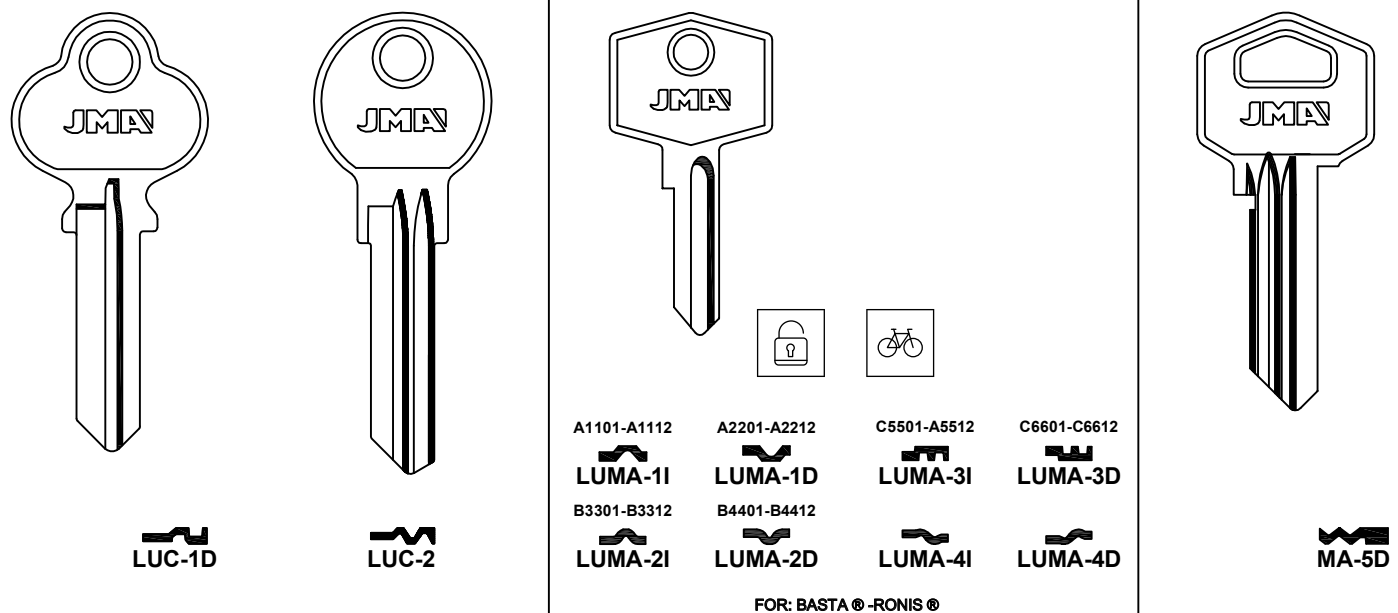

FOR: MASTER®

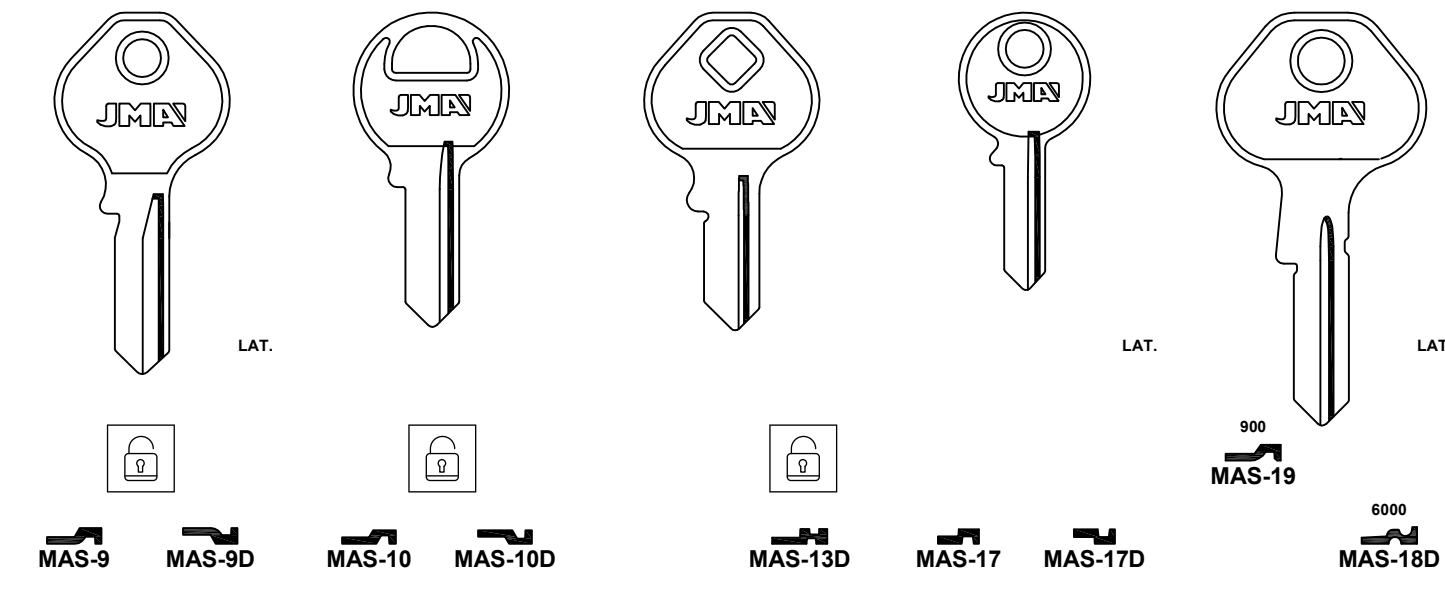

FOR: MARQUES®

FOR: MASTER®

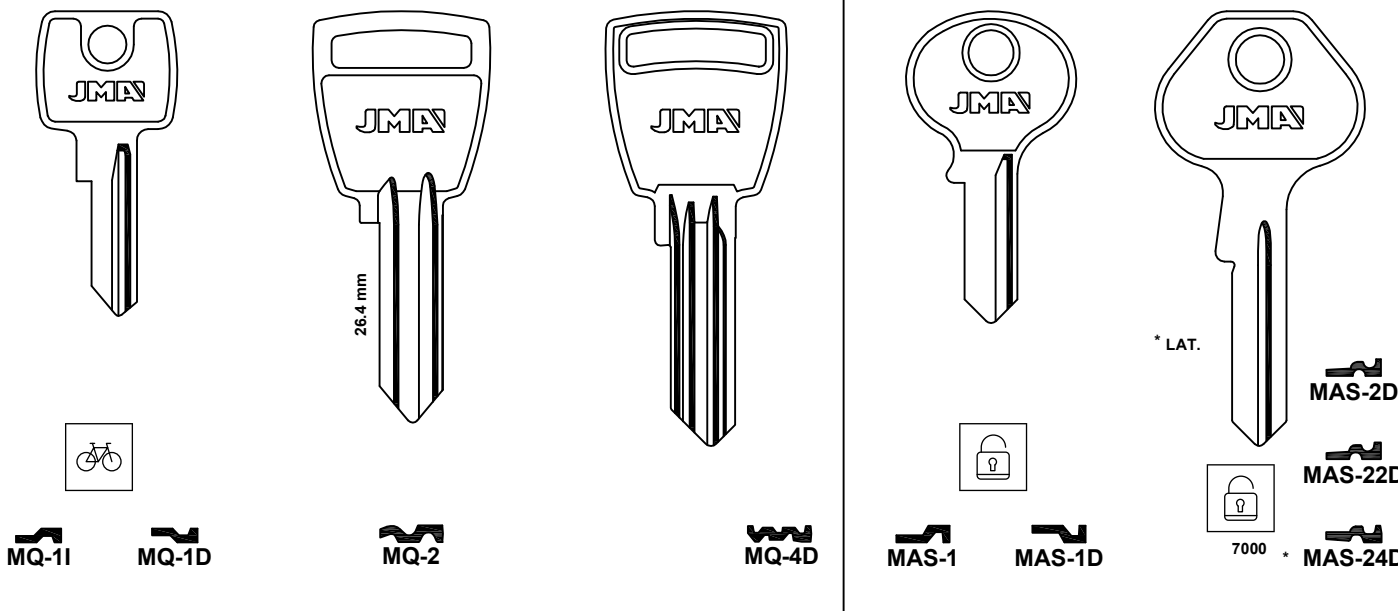

FOR: MASTER®

FOR: MAUER®

FOR: MAXUS®

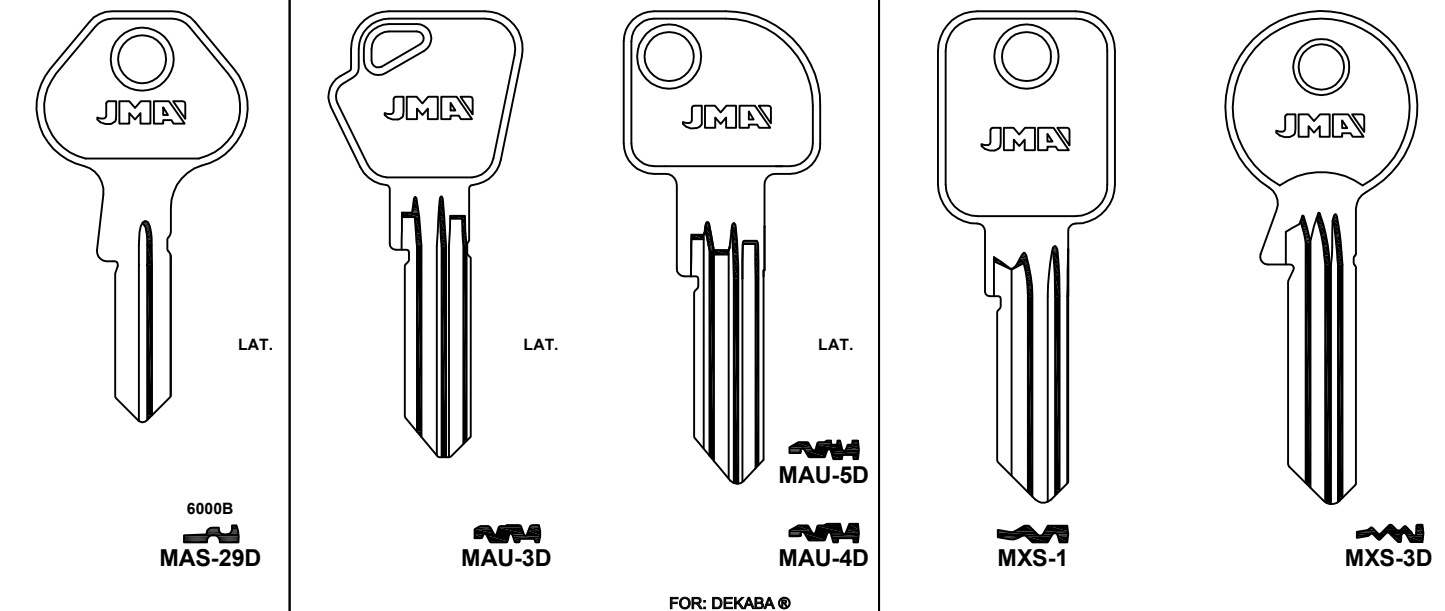

FOR: DEKABA®

Concerning the marks and commercial denominations see legal warning.  
 Concerniente a las marcas y denominaciones comerciales ver aviso legal.  
 Marka eta izendapen komertzialiei dagokienez, ikus lege-oharra.  
 Concernant les marques et dénominations commerciales voir la note dans l'index.

**JMA**® Opening the future

**JMA**® Opening the future

Beziehen auf die marke und handelsname sehen sie die notiz im Impressum.  
 Relativamente às marcas e denominações comerciais, ver aviso legal.  
 Jeśli chodzi o znaki i nazwy handlowe, patrz Informacje prawne.



**FOR: MCL®**

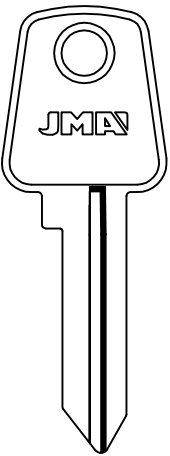

**MCL-1D**

**FOR: MCM®**

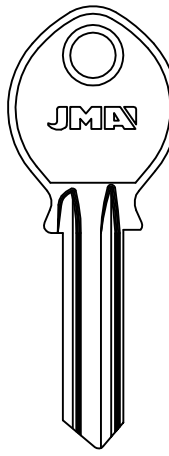

**MCM-1**

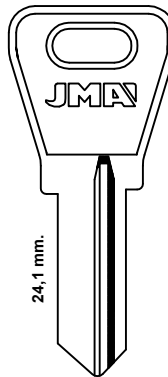

24,1 mm.  
**MCM-2I**



**MCM-2D**

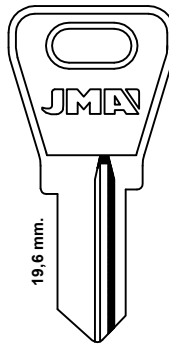

19,6 mm.  
**MCM-3I**



**MCM-3D**

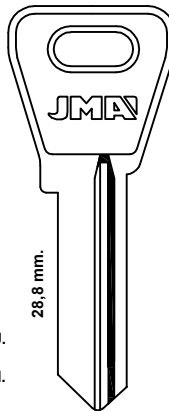

28,8 mm.  
\* ALU.  
\* FSH.  
**MCM-4I**



**MCM-4D**



**MCM-4EC**

FOR: ESAFE®-K+K®

**FOR: MCM®**

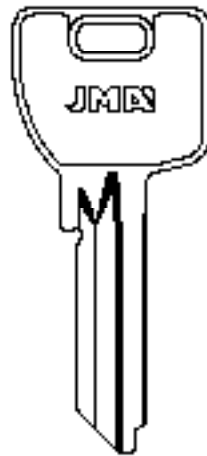

**MCM-30D**

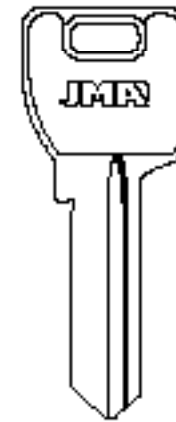

**MCM-31**

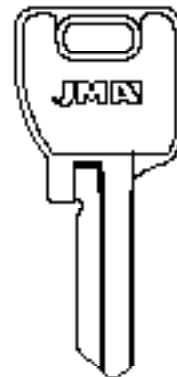

**MCM-31D**



**MCM-32D**



**MCM-33**



**MCM-35**

**FOR: MCM®**

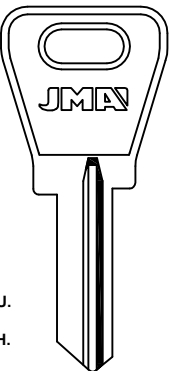

\* ALU.  
\* FSH.  
**MCM-5I**



**MCM-5D**

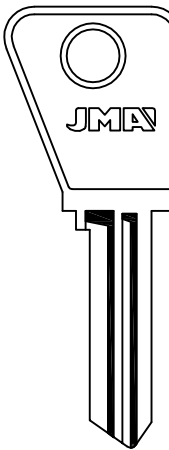

**MCM-6**

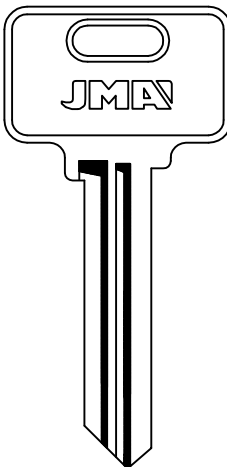

**MCM-7**

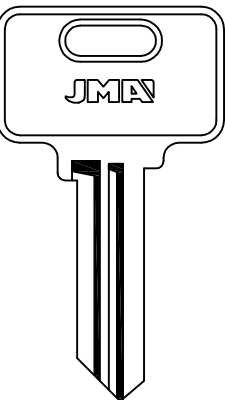

**MCM-8**

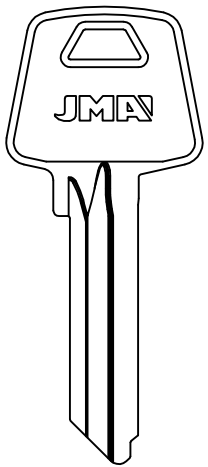

**MCM-12D**

FOR: COFER®

**FOR: ME-FA®**

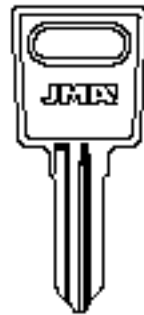

**ME-FA-1**

**FOR: MECO®**

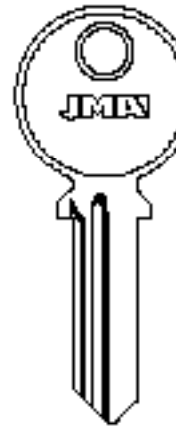

**MECO-5D**

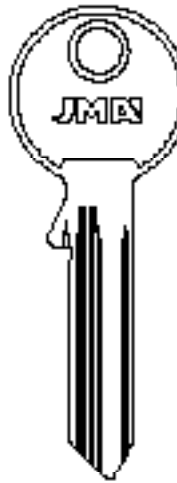

**MECO-6**

**FOR: MEDOS®**



**MEDOS-2D**



**MEDOS-1D**

**FOR: MELSMETALL®**



**MEL-1**



**MEL-4**



**MEL-4D**

**FOR: MCM®**

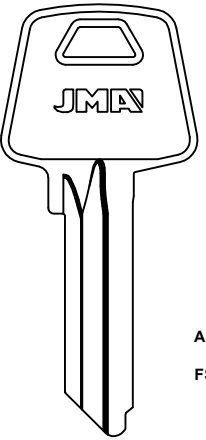

**MCM-13D**

ALU.  
FSH.

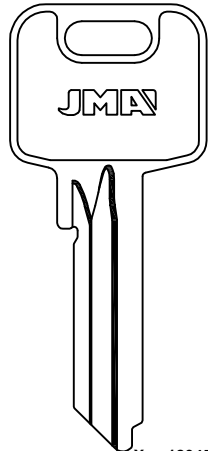

X.....1234567890  
E.....11241-79868  
E-1  
**MCM-18D**



**MCM-24B**



**MCM-24C**



**MCM-24D**



**MCM-24E**



**MCM-24F**



**MCM-26**

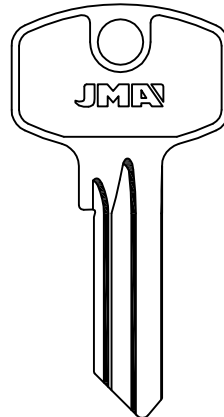

**MCM-29D**

FOR: HEGEL®

**FOR: MELSMETALL®**



**MEL-2I**



**MEL-3**

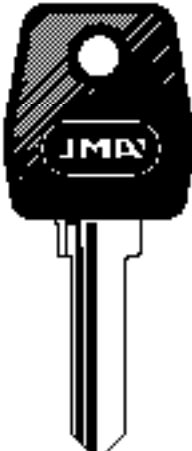

**MEL-SP**

**FOR: MERONI®**

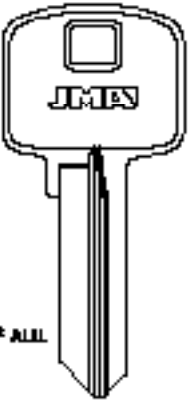

\* ALL  
**MER-1D**

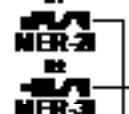

**MER-2I**



**MER-3I**



**MER-4I**



**MER-5I**



**MER-6I**

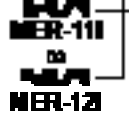

**MER-7I**

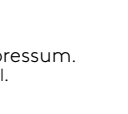

**MER-8I**



**MER-9I**



**MER-10I**



**MER-11I**

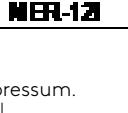

**MER-12I**



**MER-13I**



**MER-14I**

Concerning the marks and commercial denominations see legal warning.  
 Concerniente a las marcas y denominaciones comerciales ver aviso legal.  
 Marka eta izendapen komertzialiei dagokienez, ikus lege-oharra.  
 Concernant les marques et dénominations commerciales voir la note dans l'index.

FOR: MERONI ®

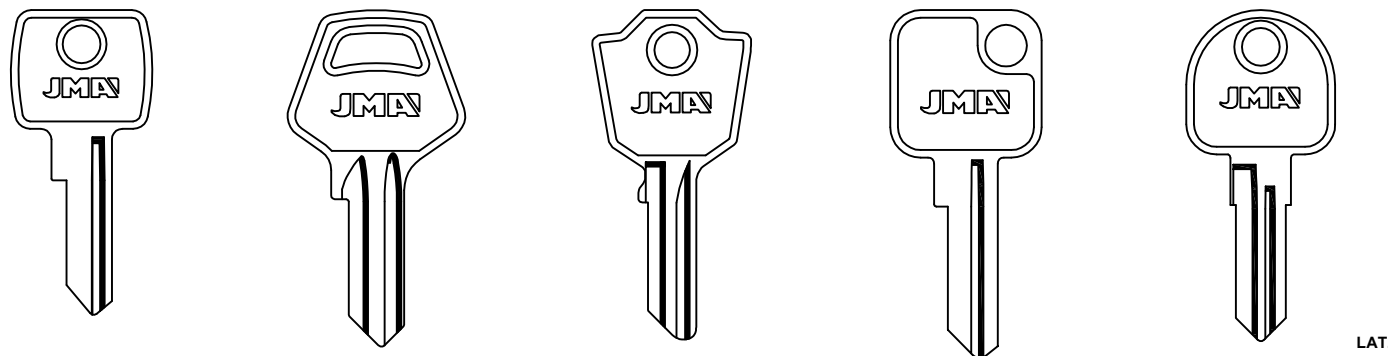

MER-15      1001-1500  
MER-16      MER-16D  
MER-17      G...3001-3480  
MER-18      G...0-480  
MER-19D      ...3001-3480

FOR: LAMA ®

FOR: LAMA ®

FOR: PREMI ® -APRI ®

FOR: MILA ®

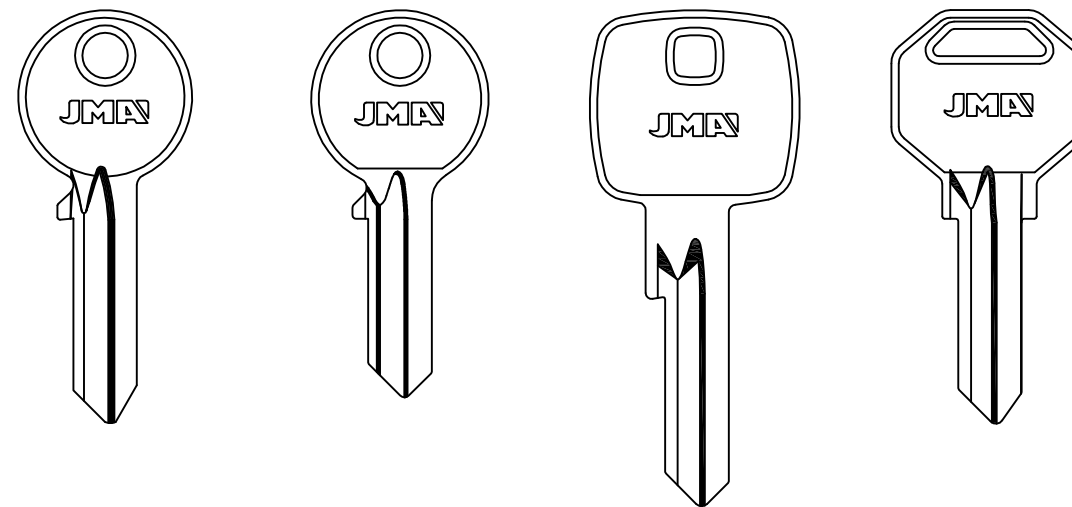

MI-2D      MI-3D      MI-4D      MI-5D

FOR: TRINITY ®

FOR: MILES ®

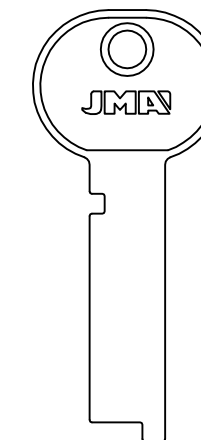

MIL-1

FOR: MI

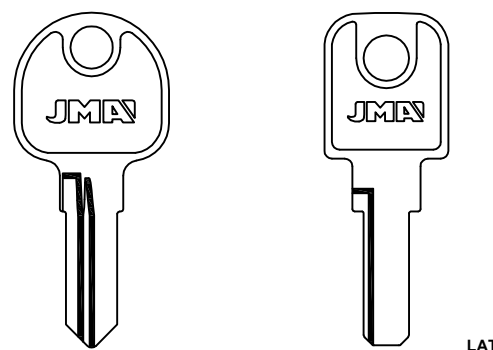

CC  
MER-20D  
CD  
MER-21D

MER-22D

FOR: METAL ®

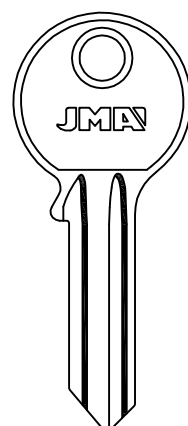

MTL-1      MTL-1D

FOR: METALUX ®

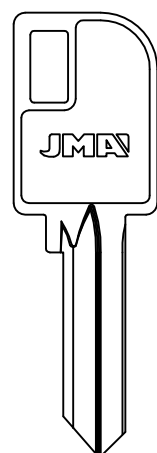

MET-2D

FOR: CAS ® -CISMA ®

FOR: METEOR ®

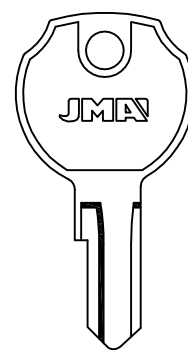

B...1-600  
G...1-600  
MTO-1

FOR: MILES ®

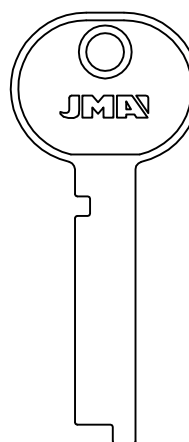

MIL-2

FOR: MING-TAY ®

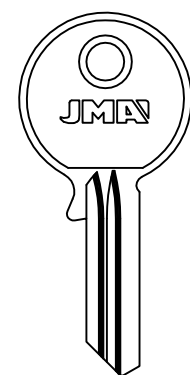

MIN-1D

FOR: MISCELLANEOUS ®

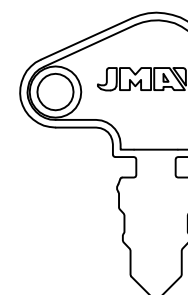

MIS-1

FOR: MIWA ®

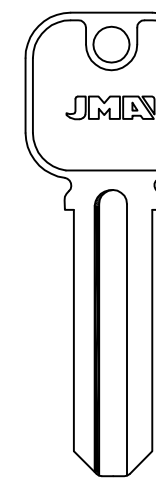

MIW-1

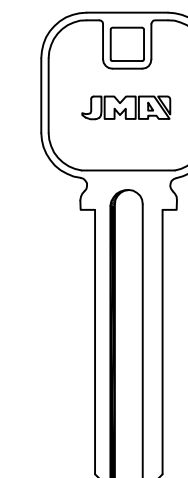

MIW-2

FOR: METIZ ®

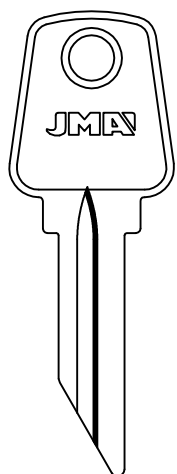

MEZ-1D

FOR: MG (MONTI) ®

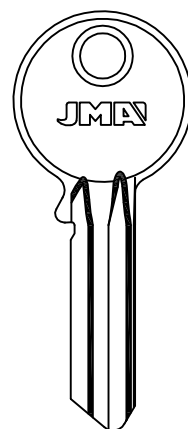

MGA-1      MGA-1D

FOR: MICHEL-SEAT ®

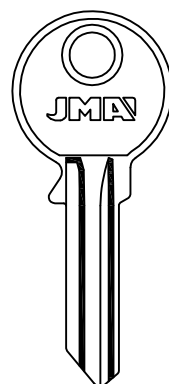

MCH-1      MCH-1D

FOR: OMR ® -POTENT ®

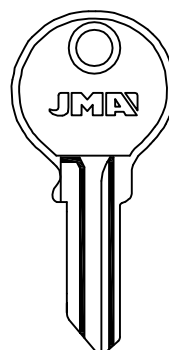

MCH-2      MCH-2D

FOR: AM ® -POTENT ®

FOR: MILA ®

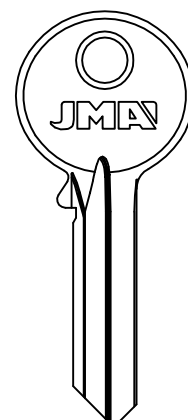

MI-1D

FOR: MIWA ®

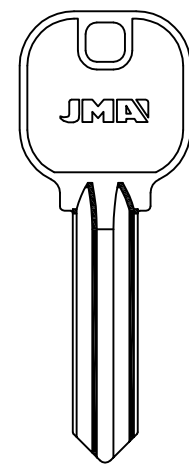

1-2-3-4  
1-2-3-4-5  
MIW-3

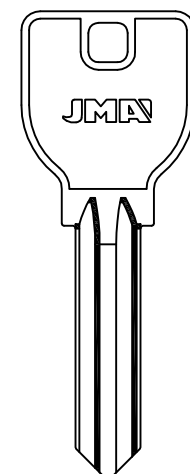

1-2-3-4  
1-2-3-4-5  
MIW-4

FOR: MLM ®

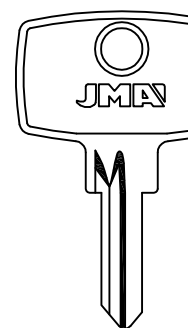

L...1-101  
L...1-222  
MLM-1D

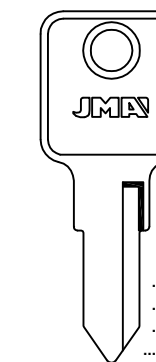

MLM-2

MLM-5

MLM-9

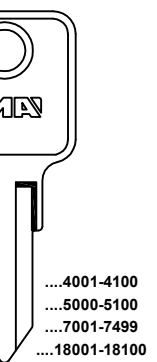

MLM-5D

FOR: DOM ® -LEHMANN ® -ORDO ® -STUV ®

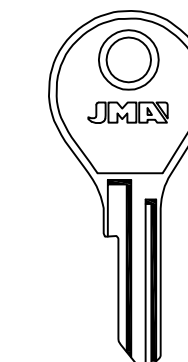

MLM-3

Concerning the marks and commercial denominations see legal warning.  
Concerniente a las marcas y denominaciones comerciales ver aviso legal.  
Marka eta izendapen komertzialiei dagokienez, ikus lege-oharra.  
Concernant les marques et denominations commerciales voir la note dans l'index.

**JMA** Opening the future

**JMA** Opening the future

Beziehen auf die marke und handelsname sehen sie die notiz im Impressum.  
Relativamente às marcas e denominações comerciais, ver aviso legal.  
Jeśli chodzi o znaki i nazwy handlowe, patrz Informacje prawne.

K01 / 79

FOR: MLM®  MLM-6  MLM-7	FOR: MOBELLA®  MBL-1  MBL-1D	FOR: MOGILEV®  MOG-1D	FOR: MON®  MON-11  MON-1D  MON-21  MON-2D	
-------------------------------------	--	-----------------------------	---	--

FOR: MSV®  MSV-1  MSV-2	FOR: MULT.LOCK®  MU-6  MU-6D	FOR: NATIONAL CABINET®  NTC-6  NTC-10D	FOR: NEMEF®  NEF-4  NEF-3
-------------------------------------	--	--	---------------------------------------

FOR: MONOBLOC®  MNO-1D FOR: FO®	FOR: MOSRENTGUEN®  MR-1  MR-2  MR-3		
--	---	--	--

FOR: NOVA®  NO-1 FOR: ABUS® -TOP®	FOR: NOXXA®  NOX-1	FOR: OCARIZ®  OCA-1D  OCA-2D	FOR: OCTAVO M.®  8M-1D	FOR: OFITA®  OF-1
--	--------------------------	--	------------------------------	-------------------------

FOR: MOTTURA®  MT-AG  MT-CG  MT-EG  MT-GG  MT-AG.P  MT-CG.P  MT-EG.P  MT-DG.P  MT-GG.P		FOR: M.P. PLODARI®  MP-11  MP-1D	FOR: MSM®  MSM-2D
--	--	--	-------------------------

FOR: OFITA®  OF-2	FOR: OJMAR®  OJ-1D  OJ-21  OJ-31  OJ-3D  OJ-71  OJ-4D			
-------------------------	---	--	--	--

Concerning the marks and commercial denominations see legal warning.  
 Concerniente a las marcas y denominaciones comerciales ver aviso legal.  
 Marka eta izendapen komertzialiei dagokienez, ikus lege-oharra.  
 Concernant les marques et dénominations commerciales voir la note dans l'index.

**JMA®** Opening the future

**JMA®** Opening the future

Beziehen auf die marke und handelsname sehen sie die notiz im Impressum.  
 Relativamente às marcas e denominações comerciais, ver aviso legal.  
 Jeśli chodzi o znaki i nazwy handlowe, patrz Informacje prawne.



FOR: OJMAR®

OJ-5I OJ-6I OJ-6D OJ-J OJ-K OJ-L OJ-M OJ-9D

FOR: HERO® -KEMEN® -RS®

FOR: OJMAR®

OJ-10 OJ-11 OJ-12 OJ-13 OJ-14 OJ-15 OJ-16 OJ-17 OJ-18.P OJ-19

FOR: BURG® -HRG® -ISKU® -KEMEN® -MOFLEX® -SISO® -STUMPF METALL® FOR: BURG®

FOR: OJMAR® FOR: OLIVA® FOR: OLIVETTI® FOR: OMA® FOR: OMEC®

OJ-21D OL-5D OLIV-1 OA-1 OMC-1D

FOR: FERMABLOCK® -PB® -PREFER® FOR: C.A.R.S.®

FOR: OMEC® FOR: OMIV® FOR: O.M.R.®

OMC-2D OMC-5D OMC-6D OMI-1 OMI-1D OM-1

FOR: CIB® -STV® FOR: MICHEL SEAT®

FOR: ORDO® FOR: ORION-NOVOX® FOR: ORO® FOR: ORSHA® FOR: PADO®

OR-1I ON-1I ON-1D ORO-1D ORK-1D PAD-1D

FOR: DECAYEUX®

FOR: PADO® FOR: PAPAIZ®

PAD-2D PAD-3 PAD-3D PAP-1 PAP-2 PAP-3

Concerning the marks and commercial denominations see legal warning.  
 Concerniente a las marcas y denominaciones comerciales ver aviso legal.  
 Marka eta izendapen komertzialiei dagokienez, ikus lege-oharra.  
 Concernant les marques et dénominations commerciales voir la note dans l'index.

**JMA**® Opening the future

**JMA**® Opening the future

Beziehen auf die marke und handelsname sehen sie die notiz im Impressum.  
 Relativamente às marcas e denominações comerciais, ver aviso legal.  
 Jeśli chodzi o znaki i nazwy handlowe, patrz Informacje prawne.

FOR: PAPAIZ®

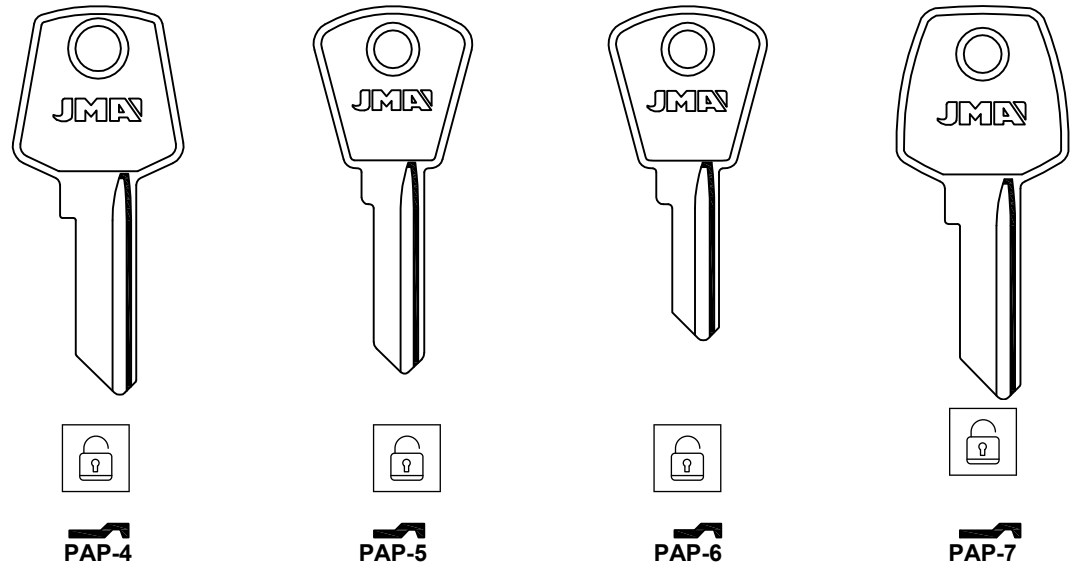

FOR: P.C.®

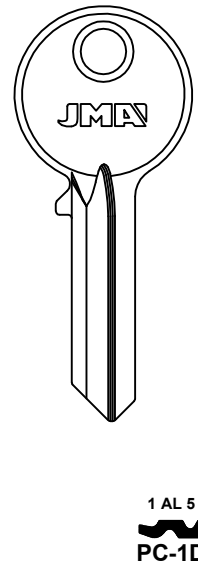

FOR: ETNA® - FEB® - FPB® - FRAL® - SANTOS®

FOR: PFAFFENHAIN®

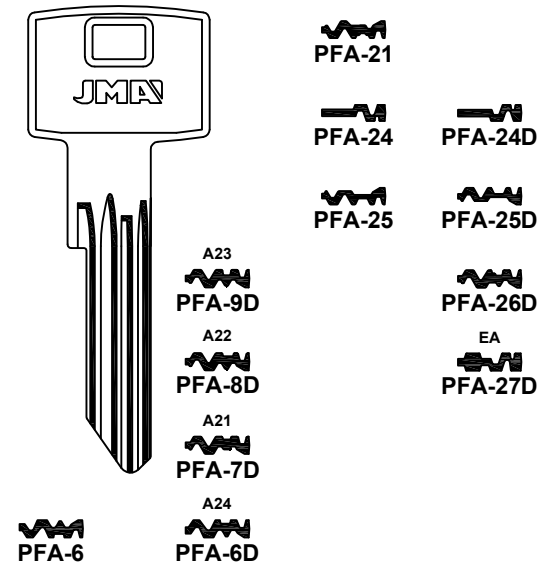

FOR: PHILLIPS®

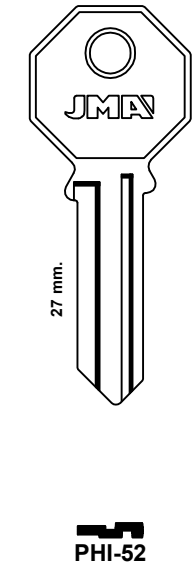

FOR: PHOENIX®

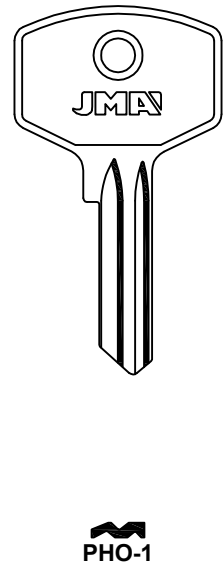

FOR: POLLUX®

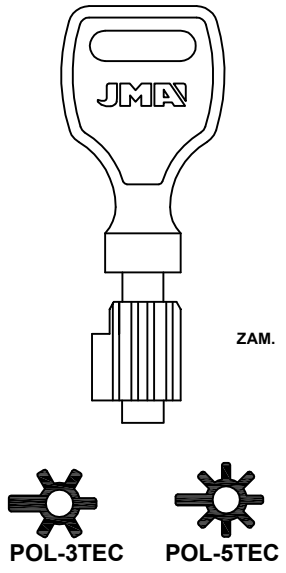

FOR: P.C.®

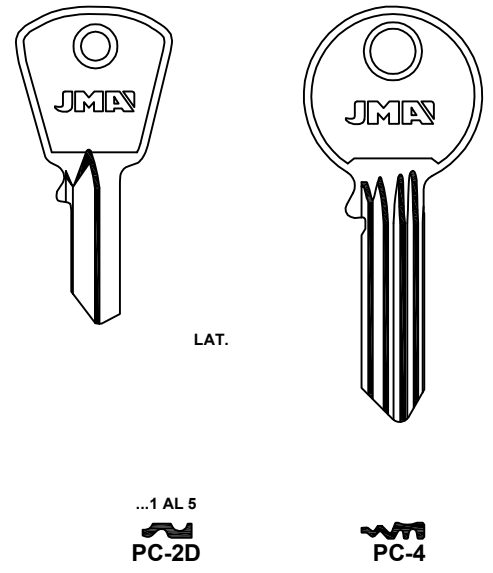

FOR: PENZMASH®

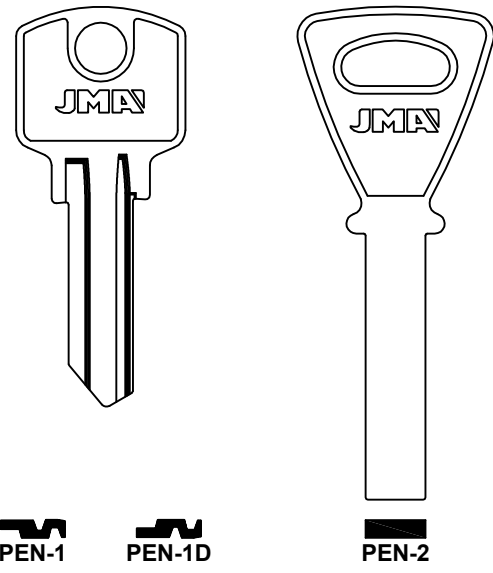

FOR: PETROZAVODSK®

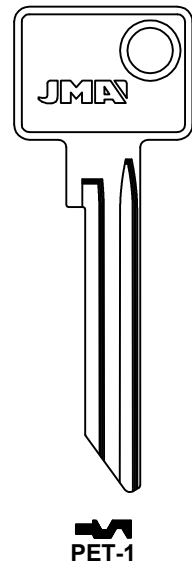

FOR: POLLUX®

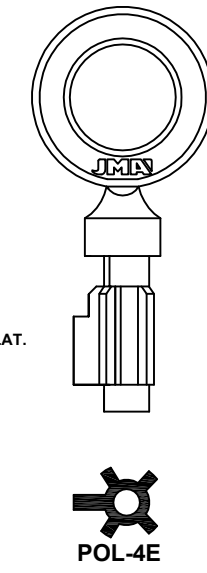

FOR: PREFER®

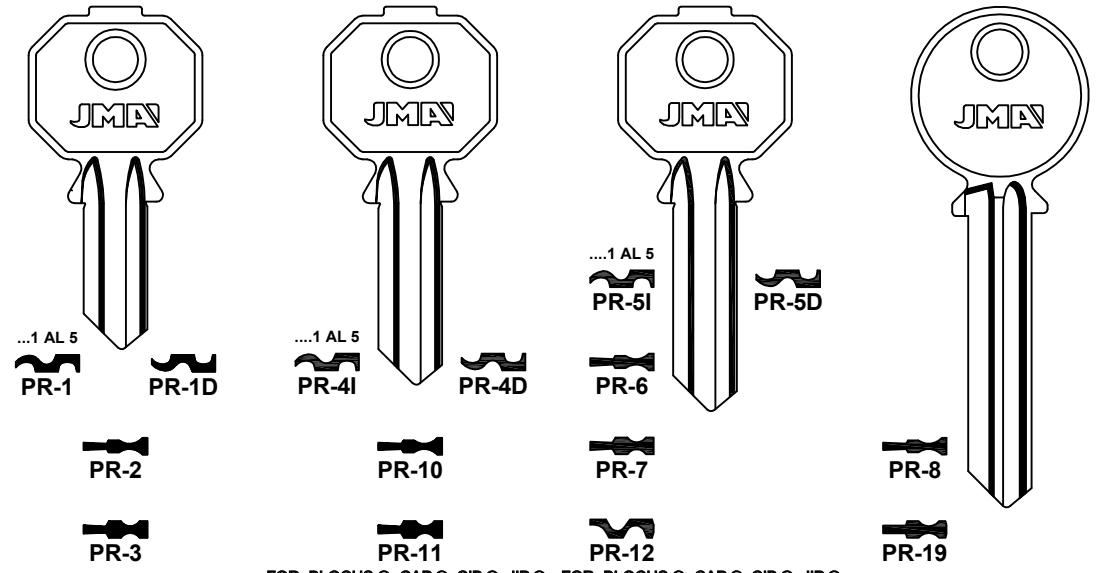

FOR: PFAFFENHAIN®

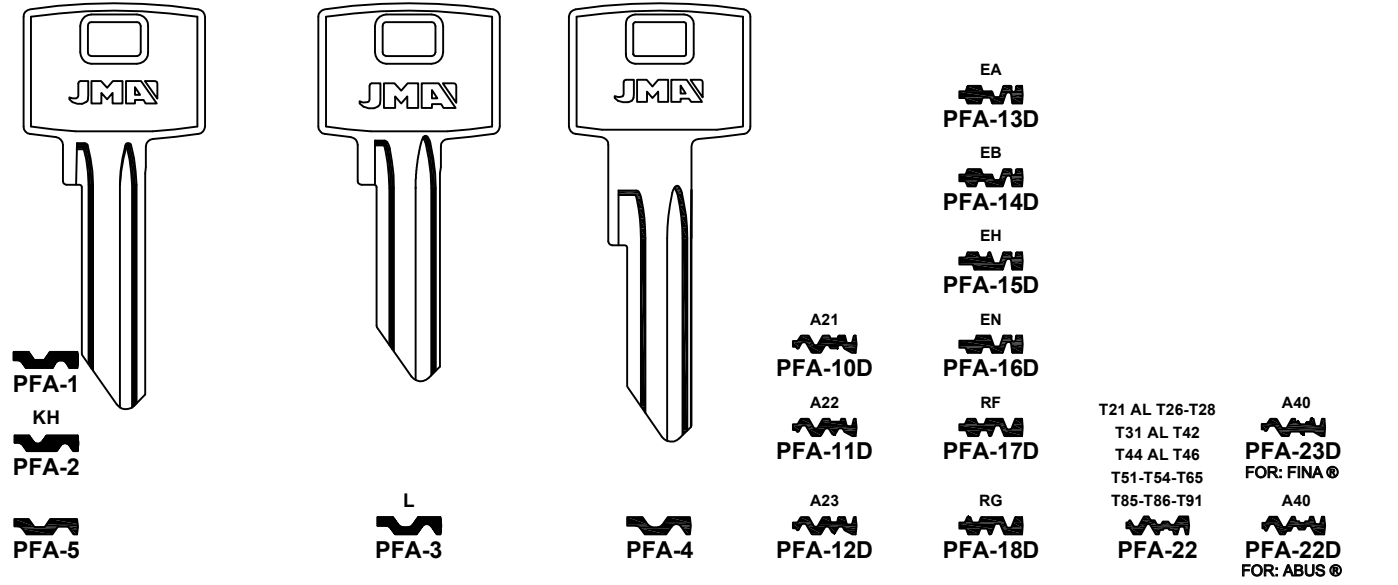

FOR: PREFER®

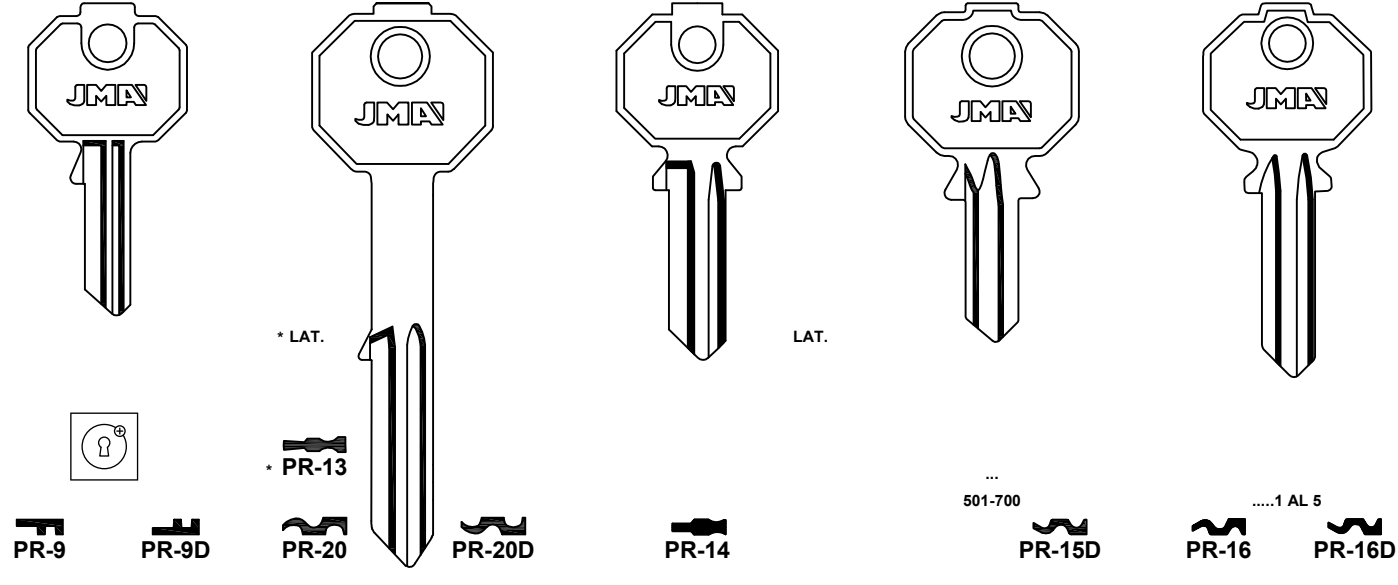

Concerning the marks and commercial denominations see legal warning.  
 Concerniente a las marcas y denominaciones comerciales ver aviso legal.  
 Marka eta izendapen komertzialiei dagokienez, ikus lege-oharra.  
 Concernant les marques et denominations commerciales voir la note dans l'index.



Beziehen auf die marke und handelsname sehen sie die notiz im Impressum.  
 Relativamente às marcas e denominações comerciais, ver aviso legal.  
 Jeśli chodzi o znaki i nazwy handlowe, patrz Informacje prawne.



FOR: RONIS®

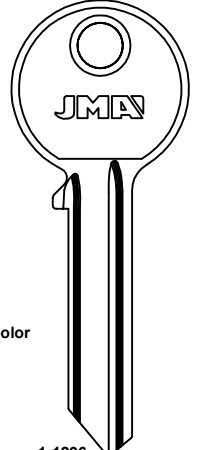

WColor

.....1-1296  
.....0 AL 9 AL 0  
.....1 AL 9

RO-24I RO-24D

FOR: ANTA® - LAPERCH® - SESA®

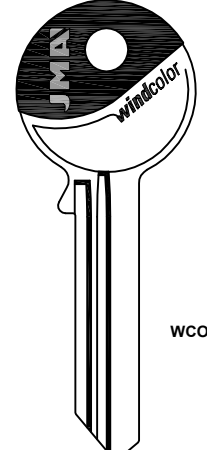

WColor

FM  
RO-25I RO-25D  
FOR: LAPERCH®



FL  
RO-26I RO-26D  
FOR: LAPERCH®



FK  
RO-27I RO-27D  
FOR: LAPERCH®

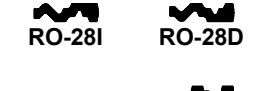

RO-28I RO-28D



RO-29I RO-29D

FOR: FTH®

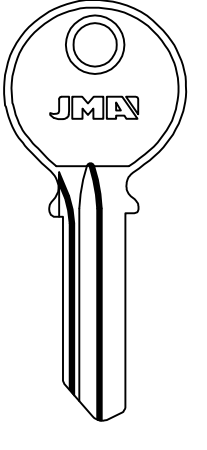

FOR: SOLOR®

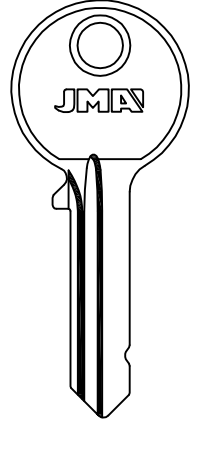

FOR: CATOR®

FOR: RONIS®

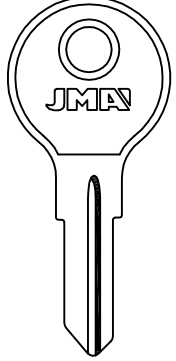

RO-36D

FOR: JD®

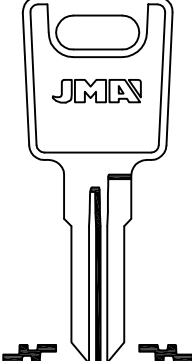

RO-37I RO-37D

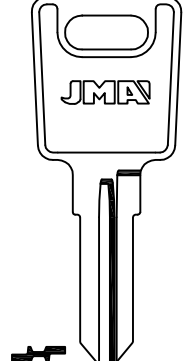

RO-39I RO-39D

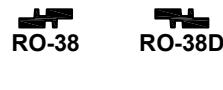

RO-38I RO-38D

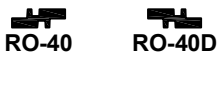

RO-40I RO-40D



RO-41I RO-41D



RO-42I RO-42D

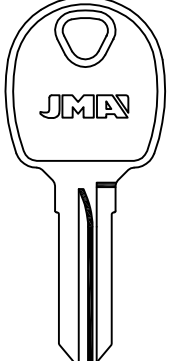

RO-43I RO-43D



RO-46I RO-46D

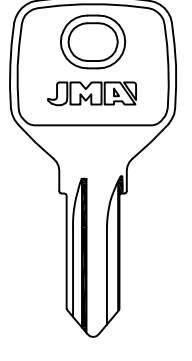

CA  
RO-44D

FOR: RONIS®

FOR: ROYAL®

FOR: RUKO®

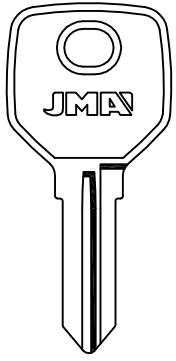

RO-45

FOR: STUV® - FOR: WSS®

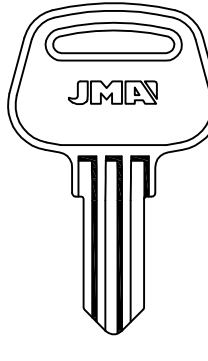

ROY-1

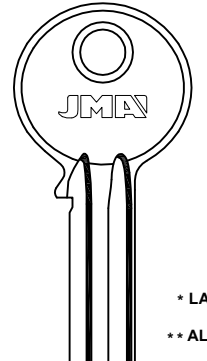

RU-1 \*\* RU-1D

FOR: DIFA®

\* LAT.  
\*\* ALU.  
\*\*\* WColor

.....1 AL 8  
.....1 AL 9  
.....1 AL 9 AL 0 A-B  
.....0 AL 9 A AL M  
S.....1 AL 9



RU-21 RU-2D



RU-3D RU-4D



RU-10D \* RU-19D



RU-TL

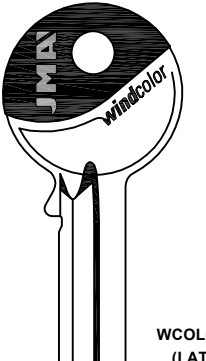

WColor (LAT.)

.....1 AL 8  
.....1 AL 9  
.....1 AL 9 AL 0 A-B  
.....0 AL 9 A AL M  
S.....1 AL 9

RU-1D

FOR: DIFA®

FOR: RUKO®

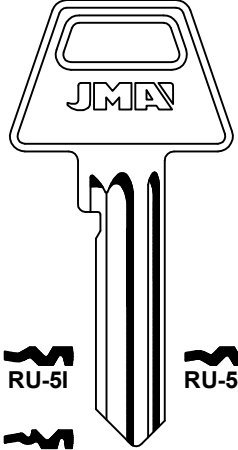

RU-5I RU-5D



RU-6I RU-6D



RU-9I RU-9D



SKB  
RU-11D



RU-12D



RU-14D



RU-15



RU-K RU-KD



RU-L



RU-M



RU-7D



FOR: ASSA®



FOR: ASSA®



FOR: ASSA®



FOR: ASSA®



FOR: ASSA®



FOR: ASSA®

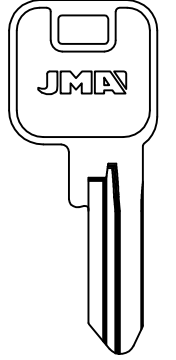

FOR: ASSA®



.....  
1 AL 9 A AL C  
RU-8D



GK  
RU-GK7



GL  
RU-GL7



GM  
RU-GM7



GS  
RU-GS7

FOR: RUKO®

FOR: RUSSIA®

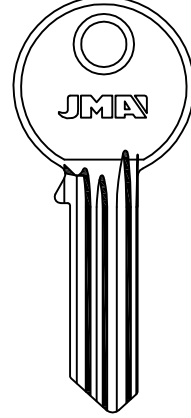

GC  
RU-GC



HNR  
RU-16D



GM  
RU-GM



GK  
RU-GK  
GL  
RU-GL



GS  
RU-GS

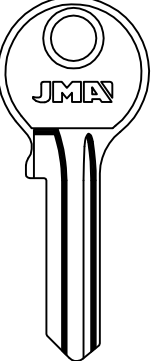

RSS-1

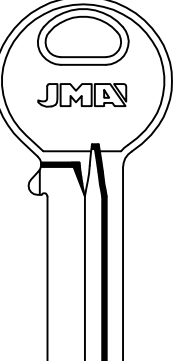

RSS-2D

FOR: RUSSIA®

FOR: RUSSWIN®

FOR: SABT®

FOR: SAM®

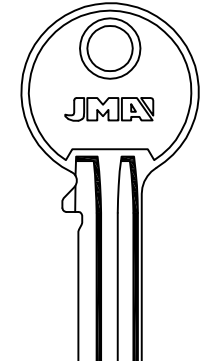

RSS-3 RSS-3D

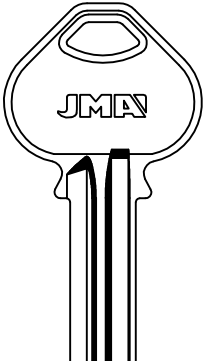

RUS-1

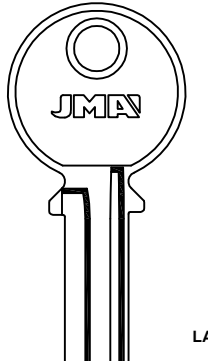

RUS-2

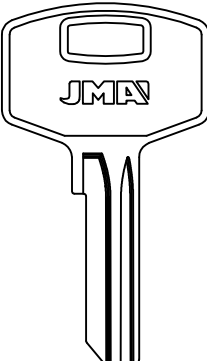

SABT-1

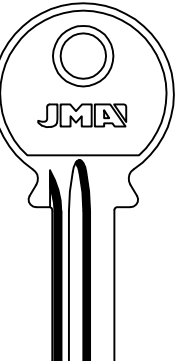

SAM-1D

Concerning the marks and commercial denominations see legal warning.  
Concerniente a las marcas y denominaciones comerciales ver aviso legal.  
Marka eta izendapen komertzialiei dagokienez, ikus lege-oharra.  
Concernant les marques et dénominations commerciales voir la note dans l'index.

**JMA**® Opening the future

**JMA**® Opening the future

Beziehen auf die Marke und Handelsname sehen sie die Notiz im Impressum.  
Relativamente às marcas e denominações comerciais, ver aviso legal.  
Jeśli chodzi o znaki i nazwy handlowe, patrz Informacje prawne.



**FOR: SAM®**

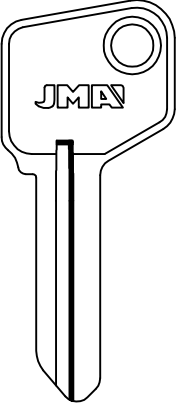

**SAM-2D**

**FOR: SAMSONITE®**

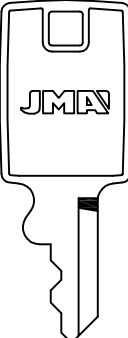

**SA-1**

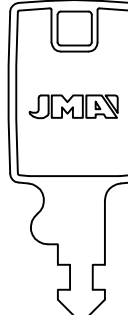

**SA-1D**

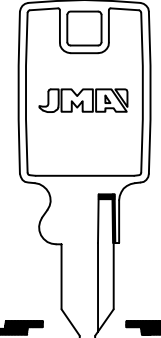

**SA-3I**

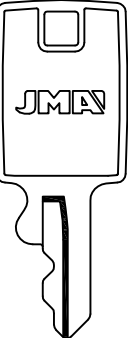

**SA-3D**

SE 041  
SE 052  
SE 083  
SE 124  
SE 165  
SE 186

**SA-4**



**SA-5D**

**FOR: SCHLAGE®**

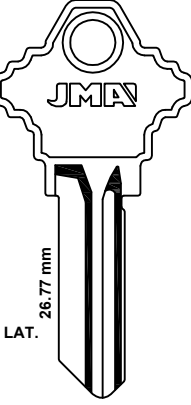

LAT. 26.77 mm

SLG-3  
CE  
SLG-13  
E  
SLG-11  
EF  
SLG-15  
F  
SLG-12  
FG  
SLG-21  
G  
SLG-22

H  
SLG-23

J  
SLG-24

K  
SLG-25

L  
SLG-14

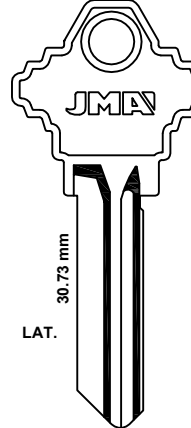

LAT. 30.73 mm

SLG-4  
CE  
SLG-8  
E  
SLG-5  
EF  
SLG-10  
F  
SLG-9  
FG  
SLG-19  
G  
SLG-18

H  
SLG-16

J  
SLG-17

K  
SLG-20

L  
SLG-6  
ACE.

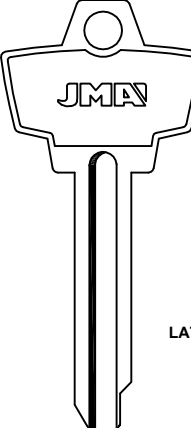

LAT.

A  
SLG-7

**FOR: SARGENT®**

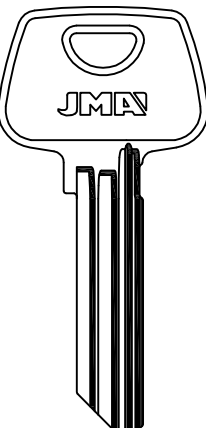

**SAR-1**

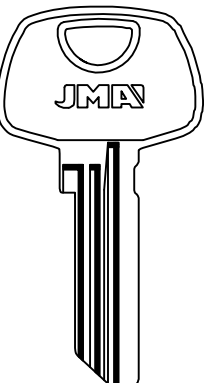

**SAR-1D**

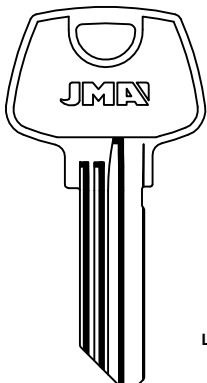

**SAR-2D**

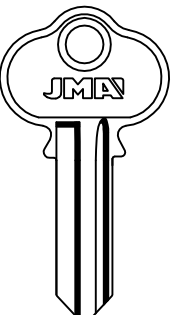

**SAR-3D**

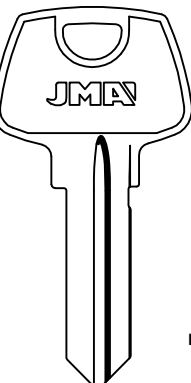

**SAR-4**

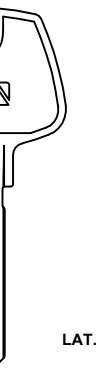

**SAR-4D**

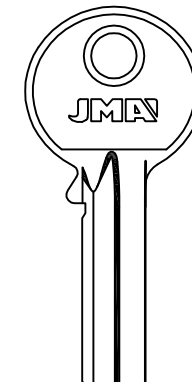

**SAR-5D**

LN  
RN  
S  
1 AL 9

FOR: BRICARD® -SHOWA®

**FOR: SCHLECHTENDAHL®**

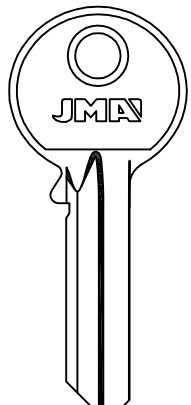

**SCH-1D**

**FOR: SCHUCO®**

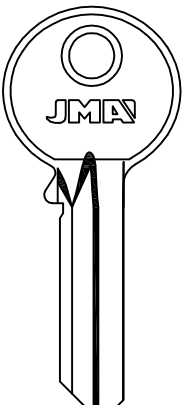

**SCC-1D**

**FOR: SELECT®**

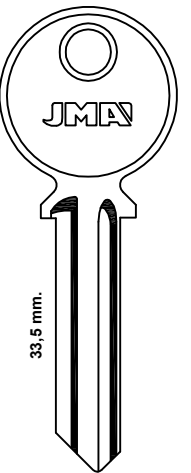

**SEL-1I**

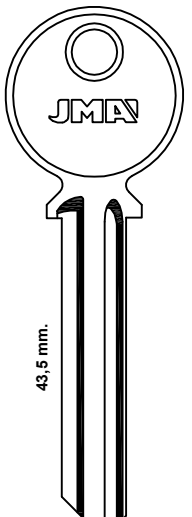

**SEL-1D**

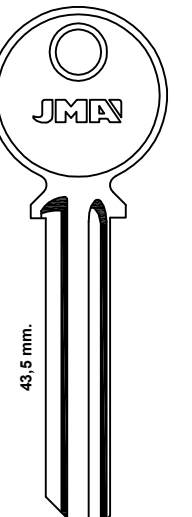

**SEL-2I**

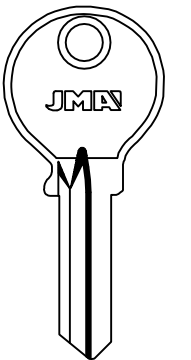

**SEL-2D**

**SEL-3D**

33.5 mm.  
43.5 mm.

FOR: CASI® -HUTRA® -NORDWEST®

**FOR: SARGENT®**

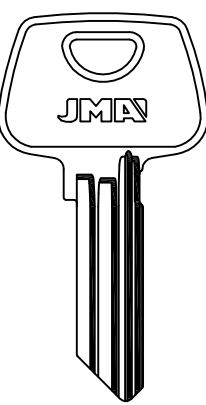

**SAR-6**

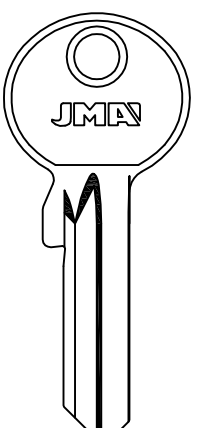

**SAR-6D**

**FOR: SATURN®**

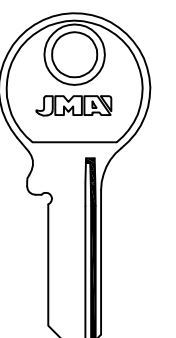

**SAT-1D**

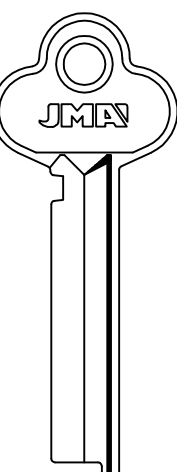

**SAT-2**

**FOR: SCHÄRER®**

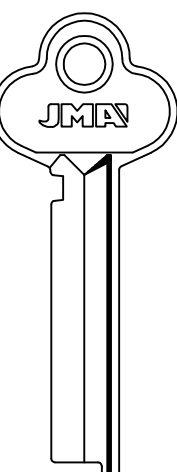

**SHR-1**

**FOR: SCHLAGE®**

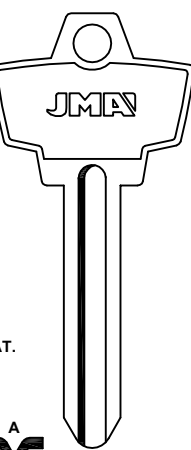

**SLG-1**



**SLG-2**

LAT.  
LAT.  
A  
W

FOR: EPO®

**FOR: SELECT®**

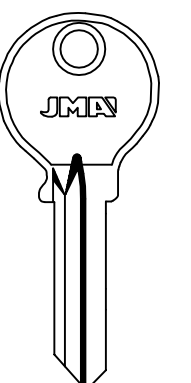

**SEL-4D**

**FOR: SELIVANOVSK®**

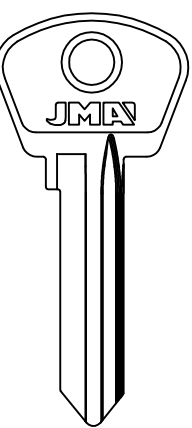

**SL-1**

**FOR: SENTRY SAFE®**

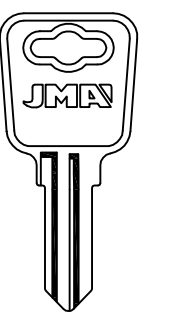

**SEN-1D**

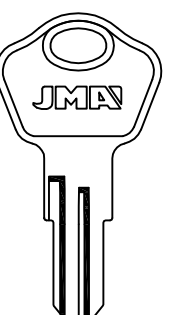

**SEN-2D**

**FOR: SERRETA®**

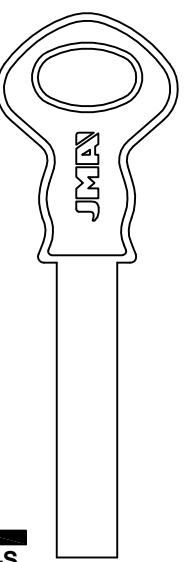

**7-S**

LAT.  
LAT.

Concerning the marks and commercial denominations see legal warning.  
 Concerniente a las marcas y denominaciones comerciales ver aviso legal.  
 Marka eta izendapen komertzialiei dagokienez, ikus lege-oharra.  
 Concernant les marques et dénominations commerciales voir la note dans l'index.

**JMA®** Opening the future

**JMA®** Opening the future

Beziehen auf die Marke und Handelsname sehen Sie die Notiz im Impressum.  
 Relativamente às marcas e denominações comerciais, ver aviso legal.  
 Jeśli chodzi o znaki i nazwy handlowe, patrz Informacje prawne.

FOR: SHANGAI®  SHA-1 FOR: CINA®	FOR: SHAW®  SH-11 FOR: HTV®-VAUGHN®-YALE®	FOR: SHAW WALKER®  SWL-1 FOR: STORWALL®	FOR: SHILUTE®  SHI-1, SHI-1D, SHI-2D, SHI-3D FOR: SHILUTE®	FOR: SIDESE®  SID-1, SID-2 57.60, 57 ZAM. FOR: SIDESE®
--	--	--	---	---

FOR: SIMECA®  SM-1, SM-2, SM-3, SM-3D, SM-4, SM-4D FOR: GUTLER®-KATE®-ORBA®, FOR: SIAM®-SIMATIC®			FOR: SIS®  SIS-1, SIS-2, SIS-6, SIS-6D, SIS-7D FOR: FEL®, FOR: UTZ®-ZENITH®	
---	--	--	--	--

FOR: SIS®  SIS-3, SIS-4D, SIS-5D, SIS-8, SIS-8D, SIS-9, SIS-9D FOR: LÁSBOLAGET®				
--	--	--	--	--

FOR: SISO®  SSO-1, SSO-2 FOR: EVERGOOD®-JOMA®	FOR: SJL®  SJL-1	FOR: SOFER®  SOF-1, SOF-2 FOR: SIL®	FOR: SOFI SONAFI®  MQ-2, SOFI-1, SOFI-1D, SOFI-2I, SOFI-2D FOR: SOBINCO®, FOR: MARC®
--	------------------------	--	---

FOR: SOFI SONAFI®  SOFI-3I, SOFI-4, SOFI-4D, SOFI-5, SOFI-6 FOR: SOBINCO®, FOR: SOBINCO®			FOR: SOLER®  SOL-1 90 mm	FOR: SOPRANO®  SOP-1D
---	--	--	-----------------------------------	-----------------------------

FOR: SOS®  SOS-1D, SOS-2D, SOS-3, SOS-4D, SOS-5 FOR: SOS®				
--	--	--	--	--

Concerning the marks and commercial denominations see legal warning.  
 Concerniente a las marcas y denominaciones comerciales ver aviso legal.  
 Marka eta izendapen komertzialiei dagokienez, ikus lege-oharra.  
 Concernant les marques et dénominations commerciales voir la note dans l'index.



Beziehen auf die marke und handelsname sehen sie die notiz im Impressum.  
 Relativamente às marcas e denominações comerciais, ver aviso legal.  
 Jeśli chodzi o znaki i nazwy handlowe, patrz Informacje prawne.

FOR: SQUIRE & S.®

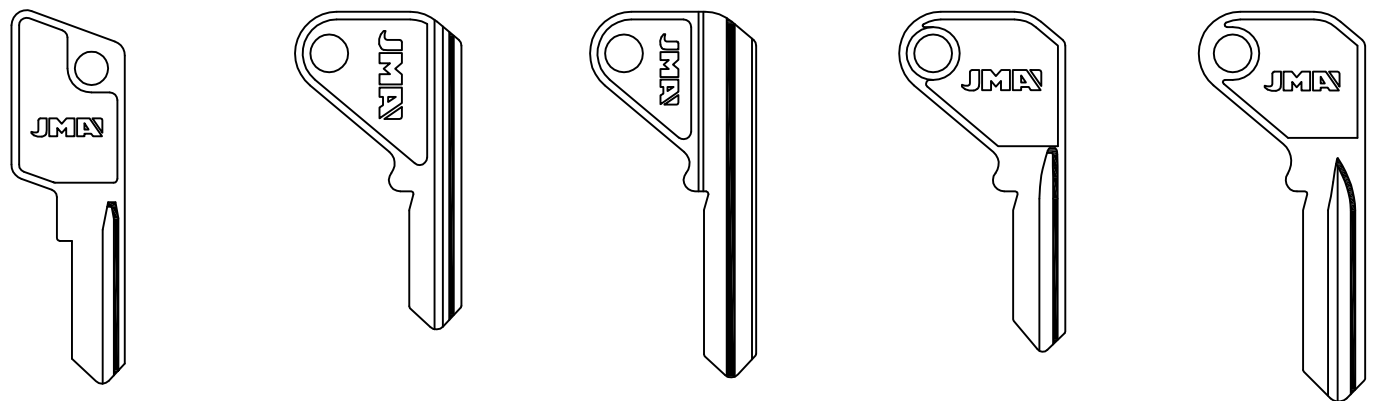

SQ-1 SQ-2 SQ-3D SQ-4 SQ-5D

FOR: SQUIRE & S.®



SQ-6 SQ-7 SQ-8D

FOR: STA-LOCK®

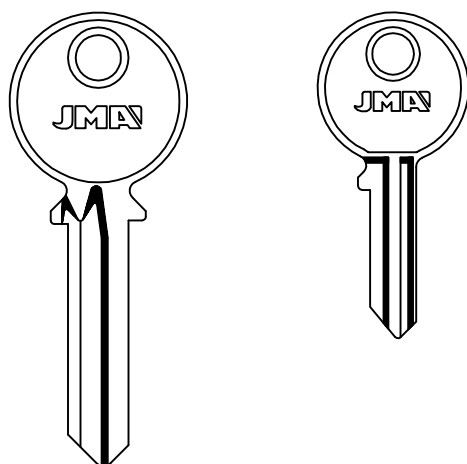

STL-1D STL-2I  
FOR: SECURE® FOR: SECURE®

FOR: STAR®

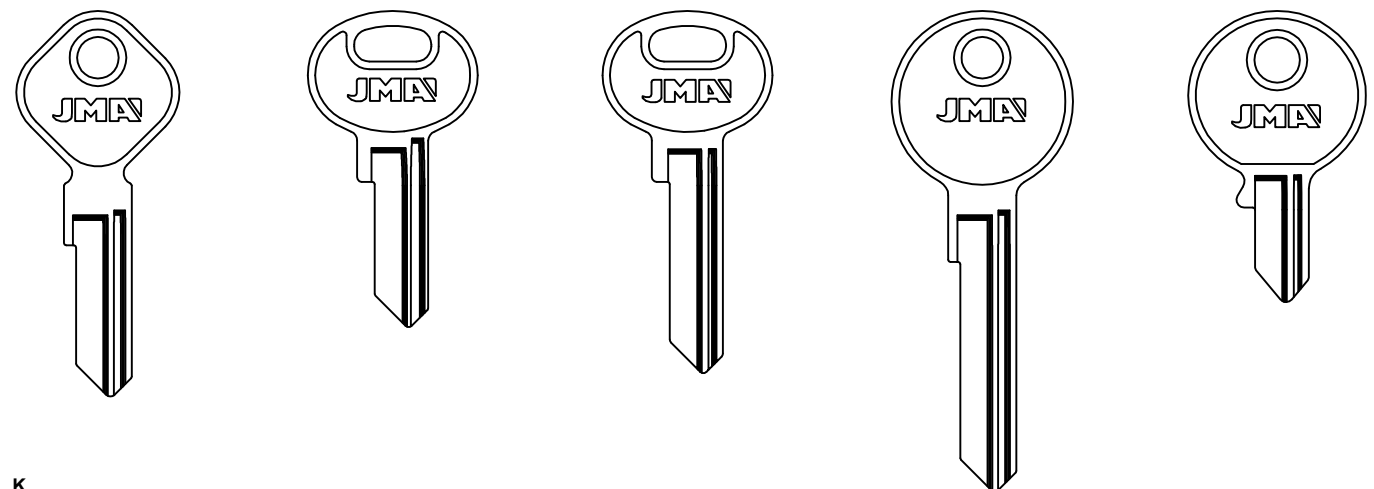

K... 1-1600  
STA-1 STA-1D STA-2 STA-2D STA-3 STA-3D STA-4 STA-4D STA-5 STA-5D

FOR: STARLET®

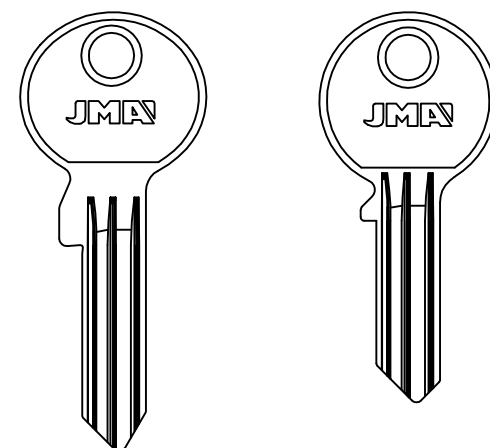

ST-1I ST-2

FOR: STEKLOMASH®

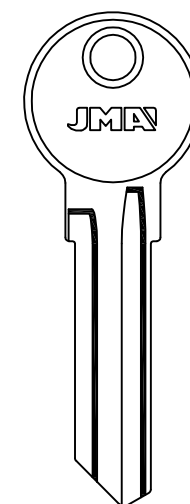

STK-1

FOR: STEM®

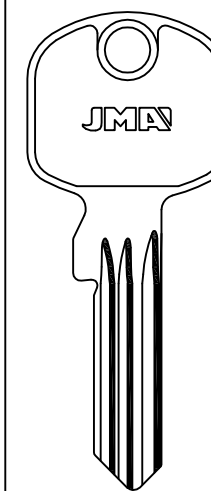

STE-1

- STE-8D
- STE-7
- STE-6
- STE-5D
- STE-4
- STE-3
- STE-2D
- STE-14D
- STE-13D
- STE-12
- STE-11
- STE-10
- STE-9D

FOR: GE GE®

FOR: STERLING®

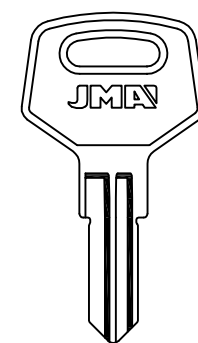

STG-1

FOR: STREBOR®

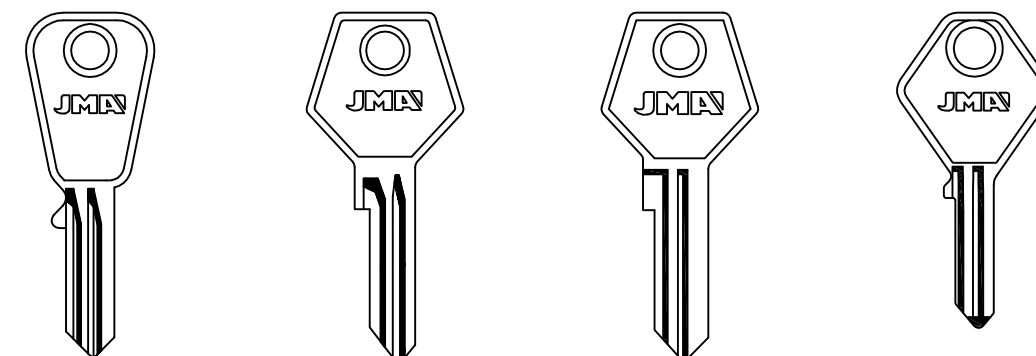

STR-1 STR-2 STR-4 STR-5  
TS...300-369 FOR: INNOCENTI®-TAYLOR®  
S..1-70

FOR: STS®

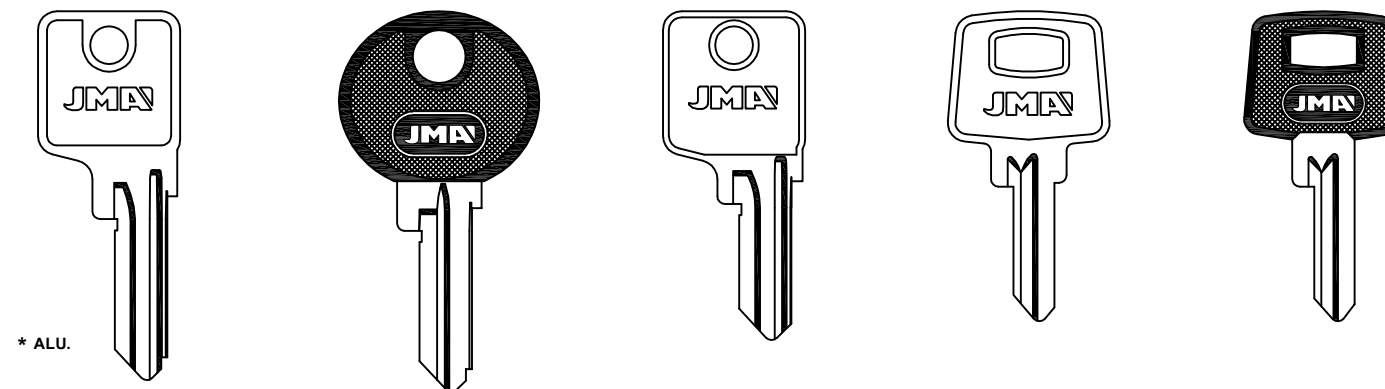

\* ALU.  
STS-1I \* STS-1D STS-28 STS-1D.P STS-3I STS-3D STS-4D STS-4D.P

FOR: SEMEL®

FOR: BTV®

FOR: BTV®

Concerning the marks and commercial denominations see legal warning.  
Concerniente a las marcas y denominaciones comerciales ver aviso legal.  
Marka eta izendapen komertzialiei dagokienez, ikus lege-oharra.  
Concernant les marques et denominations commerciales voir la note dans l'index.

**JMA**® Opening the future

**JMA**® Opening the future

Beziehen auf die marke und handelsname sehen sie die notiz im Impressum.  
Relativamente às marcas e denominações comerciais, ver aviso legal.  
Jeśli chodzi o znaki i nazwy handlowe, patrz Informacje prawne.

FOR: STS®

FOR: STUBLINA®

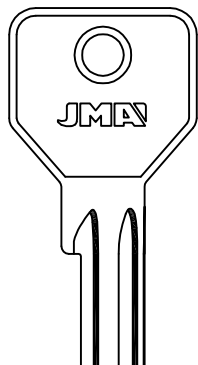
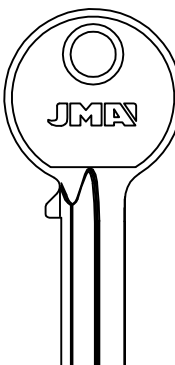
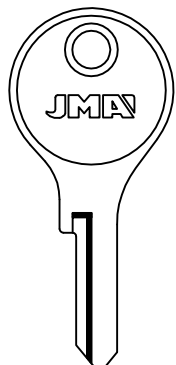
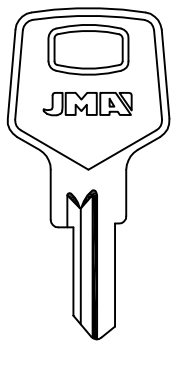
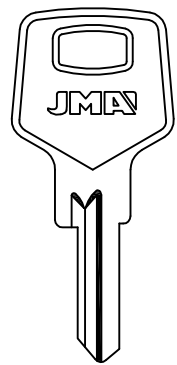

STS-6D

FOR: BTV®



STS-7D

FOR: BTV®



STS-12D

FOR: DAD®



STS-21D



STB-2



STB-2D

FOR: TALLINN®

FOR: TAYLOR®

FOR: TECHNO®

FOR: TECON®

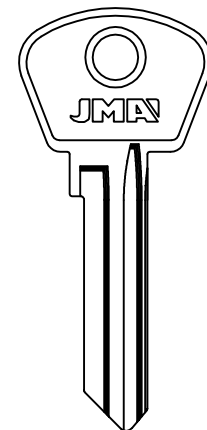

TAL-2

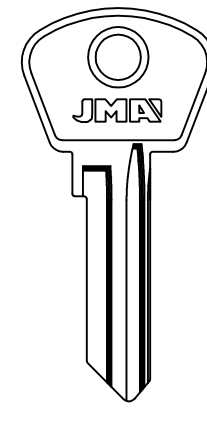

TAL-3

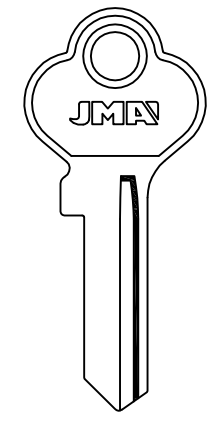

TAY-1

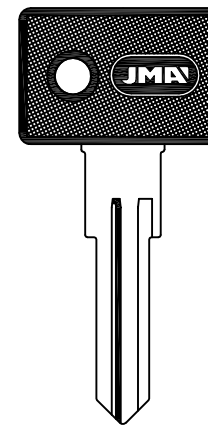

TCH-1.P



TCH-1D.P

FOR: ET.POWER®  
FOR: STARRY LOCK®-STHALEX®

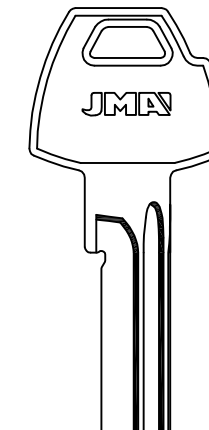

TC5



TC-2

FOR: STUMPF®

FOR: STUV®

FOR: SUREX®

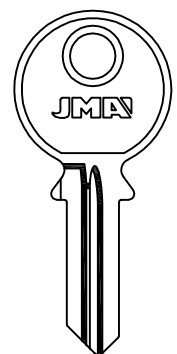

STF-1

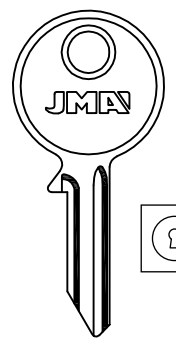

1F...201-278  
1F...Z201-278  
1F...X201-278

STUV-11

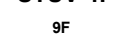

STUV-3

FOR: DOM®-MLM®

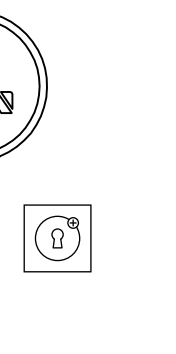

2F...  
201-278

STUV-1D



STUV-2

FOR: DOM®-MLM®

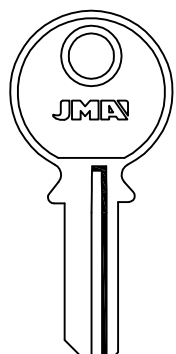

STUV-2

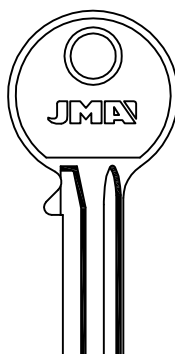

SR-1

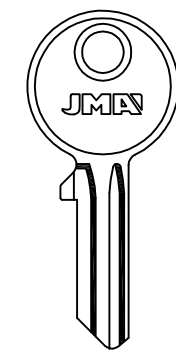

SR-2

FOR: ATLAS®

FOR: TEICOCIL®

FOR: TEKA®

FOR: TEM®

FOR: TESA®

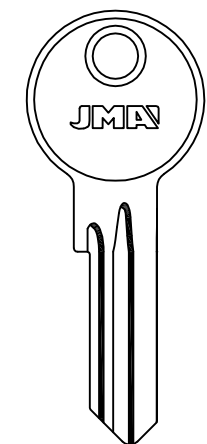

TEI-1D

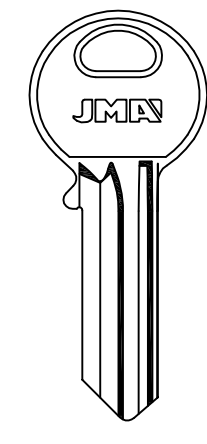

20104  
TK-2I

FOR: ASSA®-ERMEX®-LM®



20004  
TK-2D

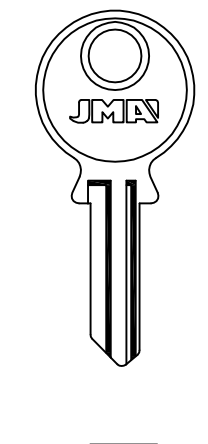

TEM-I35



TEM-D35

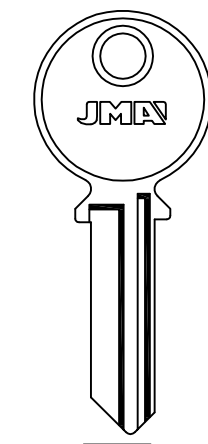

TEM-I55

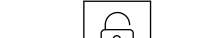

TEM-D55

FOR: CORSA®

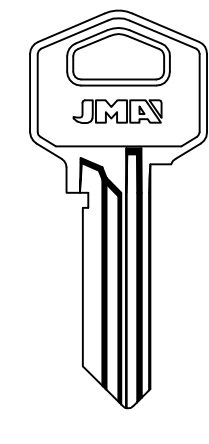

T  
TE-1I



TE-1D

FOR: SUREX®

FOR: TAITO®

FOR: TALLINN®

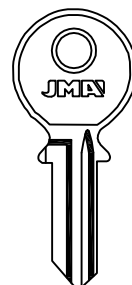

SR-3

FOR: ATLAS®-EUROP®-MATTEY®

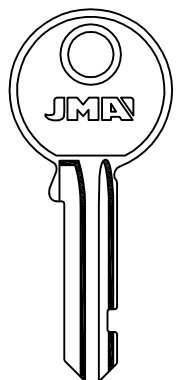

SR-4

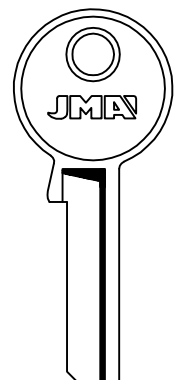

TAI-1

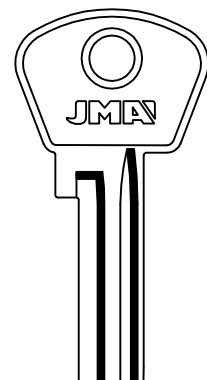

TAL-1



TAL-1D

FOR: TALLINN®

FOR: TESA®

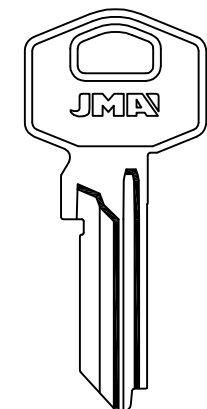

T  
TE-3

FOR: MR®

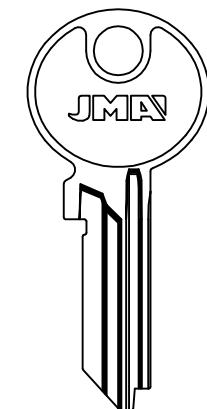

TE-4

FOR: IFOS®

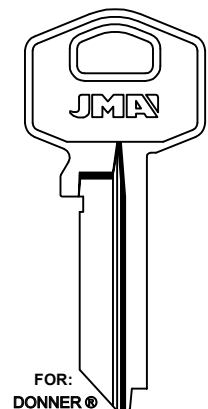

FOR:  
DONNER®  
ESCO®  
FORTRESS®  
GAINSBOROUGH®  
HARLOC®  
KAWE®  
MASTERCRAFT®  
TAYMOR®

K  
.....  
0 AL 9  
.....  
AIZ 1 AL 9

TE-7D

TE-7D

TE-7D

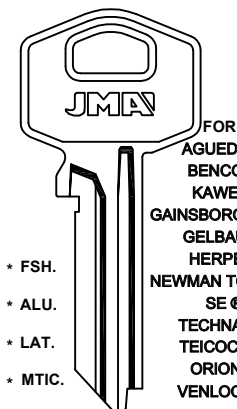

\* FSH.  
\* ALU.  
\* LAT.  
\* MTIC.  
\* WColor

TE-8I

T.....  
0 AL 9

TE-8DKT1

TE-8DKT1

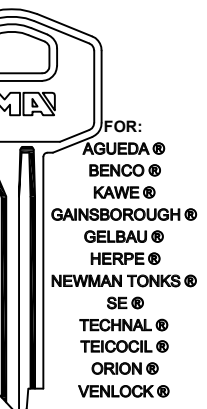

FOR:  
AGUEDA®  
BENCO®  
KAWE®  
GAINSBOROUGH®  
GELBAU®  
HERPE®  
NEWMAN TONKS®  
SE®  
TECHNAL®  
TEICOCIL®  
ORION®  
VENLOCK®

TE-8D

TE-8D

TE-8DKT1

TE-8DKT1

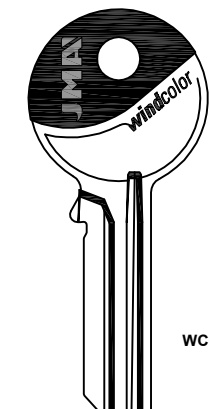

T.....  
0 AL 9

TE-8I

TE-8I

TE-8I

WColor

Concerning the marks and commercial denominations see legal warning.  
Concerniente a las marcas y denominaciones comerciales ver aviso legal.  
Marka eta izendapen komertzialiei dagokienez, ikus lege-oharra.  
Concernant les marques et denominations commerciales voir la note dans l'index.

**JMA** Opening the future

**JMA** Opening the future

Beziehen auf die marke und handelsname sehen sie die notiz im Impressum.  
Relativamente às marcas e denominações comerciais, ver aviso legal.  
Jeśli chodzi o znaki i nazwy handlowe, patrz Informacje prawne.

K01 / 97



**FOR: TESA®**

FOR:  
BURGHOWT®  
CC®  
DJC®  
ESAFE®  
IFOS®  
INSTALL®  
LUXOR®  
METALCHIMEX®  
METALUX®  
SES®  
SOS®

TE-9D

TE-10I    TE-11D    TE-23    TE-28

**FOR: TH®**

TH-1

H.R.S.-TRUMPH

**FOR: TITAN®**

TIT-2    TIT-10    TIT-19D    TIT-2GD    TIT-2D

TIT-3    TIT-4    TIT-5

FOR: FTH® -VACHETTE®

**FOR: TICINO®**

TI-1    TI-1D

FOR: BERLOTTI®

**FOR: TIFON®**

TIF-1D    TIF-2D    TIF-15/20    TIF-25D

**FOR: TITAN®**

ALU.

TIT-8D    TIT-8GI    TIT-8GD    TIT-9    TIT-9D    TIT-11D    TIT-12D    TIT-13

TECH 5+  
FOR: TECHPRO® - VBH®

FOR: LAMA®

...251-300

FOR: PICARDIE®

**FOR: TIFON®**

TIF-30D    TIF-40D    TIF-50/60

**FOR: TIGRIS®**

TIG-1D

**FOR: TITAN®**

TIT-1D

FOR: HILLMANN® -PAYKAN®

**FOR: TITAN®**

TIT-15    TIT-16D    TIT-15D    TIT-17    TIT-25    TIT-24

FOR: PICARDIE®

**FOR: T-KEY®**

TKY-1

**FOR: TOK WINKHAUS®**

TOK-2    TOK-2D

FOR: TRELOCK®

Concerning the marks and commercial denominations see legal warning.  
 Concerniente a las marcas y denominaciones comerciales ver aviso legal.  
 Marka eta izendapen komertzialiei dagokienez, ikus lege-oharra.  
 Concernant les marques et dénominations commerciales voir la note dans l'index.

**JMA®** Opening the future

**JMA®** Opening the future

Beziehen auf die Marke und Handelsname sehen Sie die Notiz im Impressum.  
 Relativamente às marcas e denominações comerciais, ver aviso legal.  
 Jeśli chodzi o znaki i nazwy handlowe, patrz Informacje prawne.

FOR: TOK WINKHAUS®

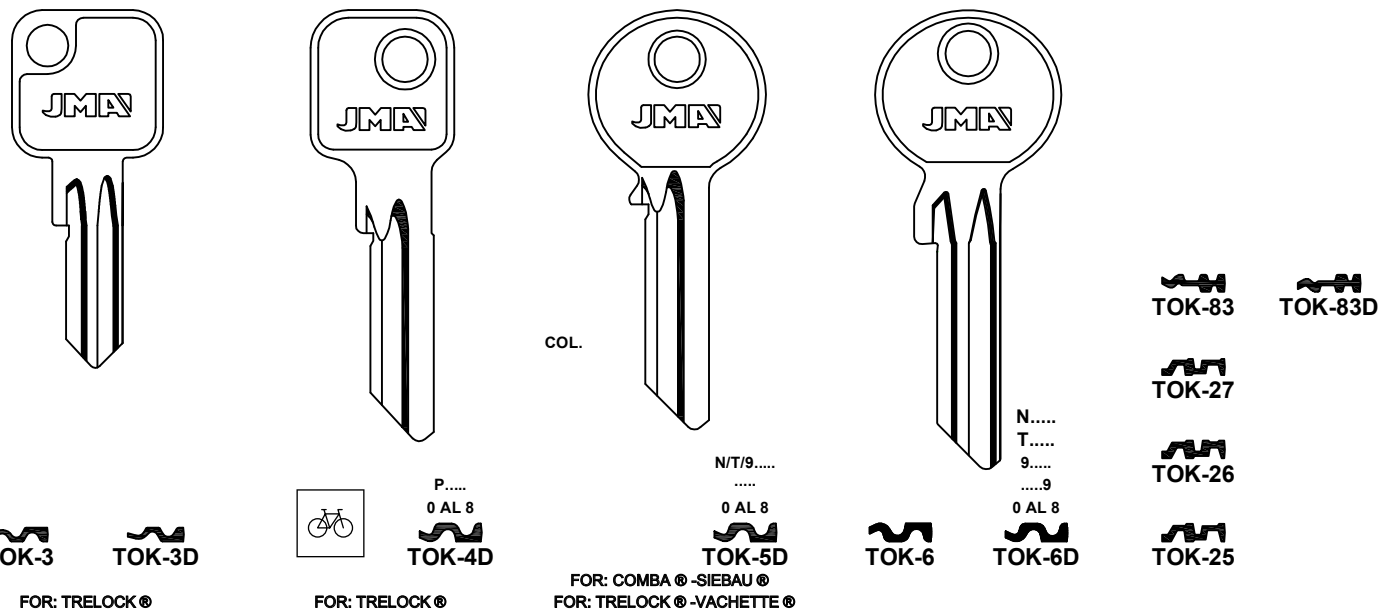

FOR: TOK WINKHAUS®

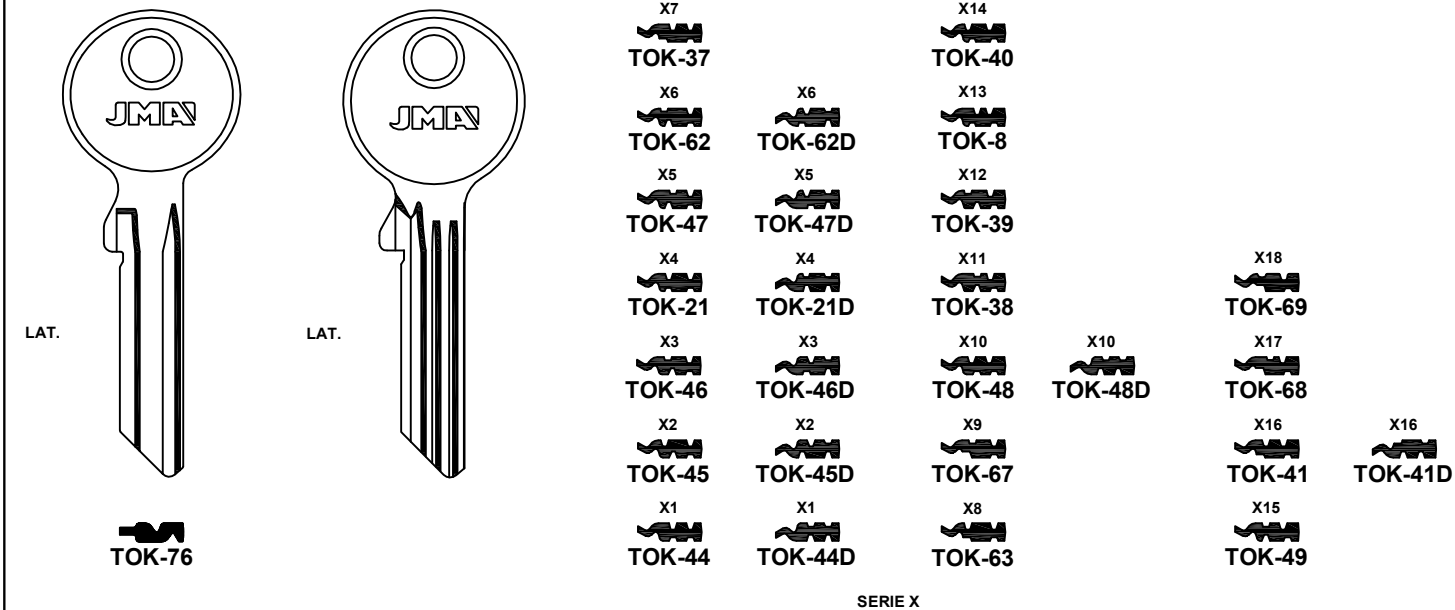

FOR: TOK WINKHAUS®

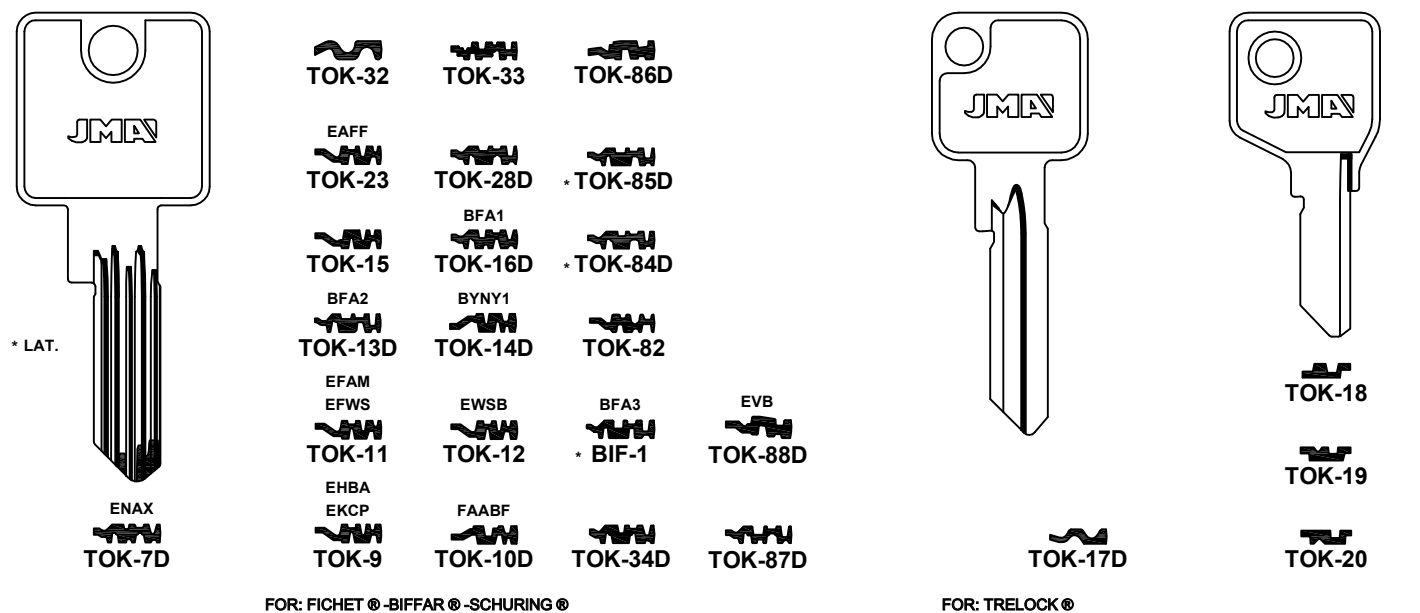

FOR: TOK WINKHAUS®

FOR: TOMSK®

FOR: TOP®

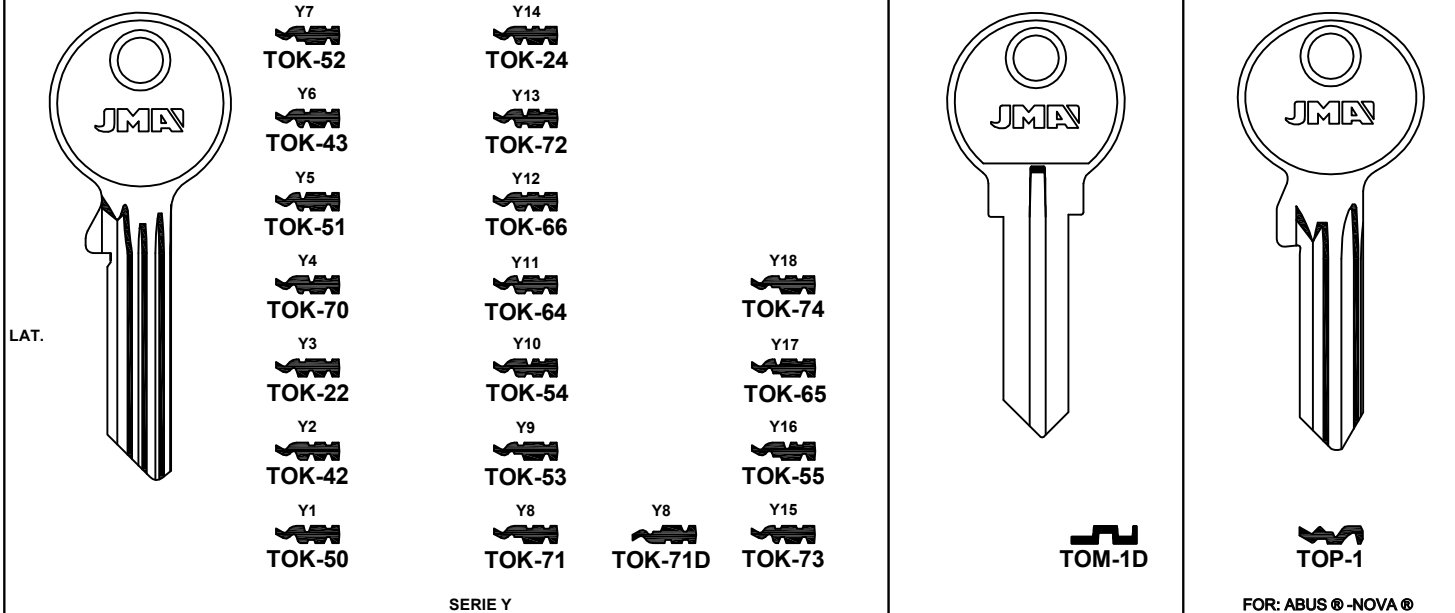

FOR: TOK WINKHAUS®

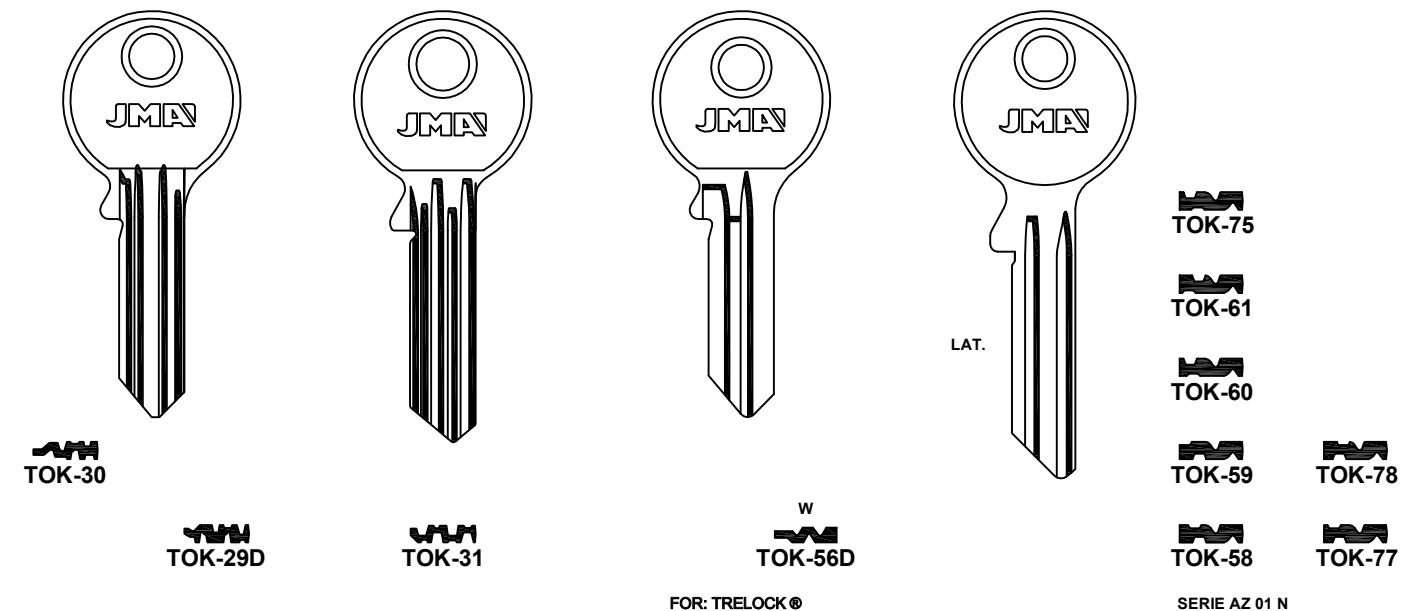

FOR: TOUCH®

FOR: TOVER®

FOR: TRAVEX®

FOR: TRELOCK®

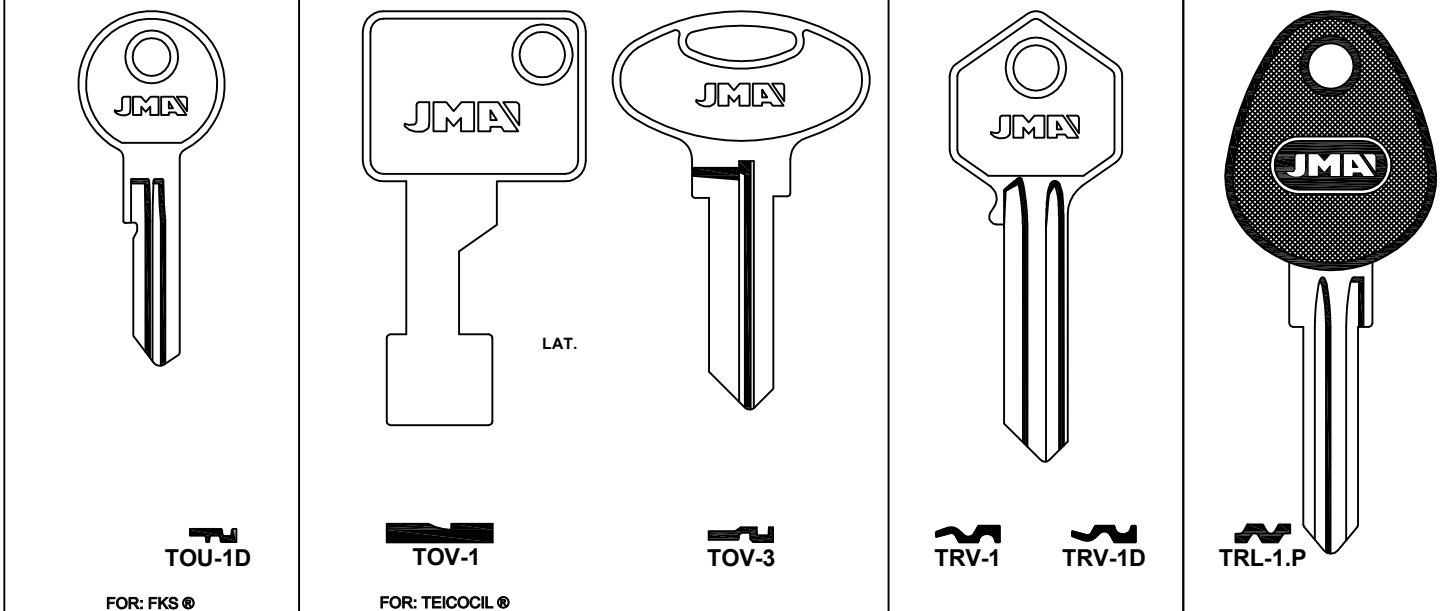

Concerning the marks and commercial denominations see legal warning.  
 Concerniente a las marcas y denominaciones comerciales ver aviso legal.  
 Marka eta izendapen komertzialiei dagokienez, ikus lege-oharra.  
 Concernant les marques et denominations commerciales voir la note dans l'index.

**JMA** Opening the future

**JMA** Opening the future

Beziehen auf die marke und handelsname sehen sie die notiz im Impressum.  
 Relativamente às marcas e denominações comerciais, ver aviso legal.  
 Jeśli chodzi o znaki i nazwy handlowe, patrz Informacje prawne.

FOR: TRELOCK®

FOR: HAMPTON®

FOR: TRI STAR®

FOR: TRI-CIRCLE®

FOR: TRIMARK®

FOR: TRI-CIRCLE®

FOR: MARK®

FOR: ELEPHANT®

FOR: TRIO-VING®

FOR: TRIO®

FOR: TRI-CIRCLE®

FOR: TRIO-VING®

FOR: JOLI SAFE®

Concerning the marks and commercial denominations see legal warning.  
 Concerniente a las marcas y denominaciones comerciales ver aviso legal.  
 Marka eta izendapen komertzialiei dagokienez, ikus lege-oharra.  
 Concernant les marques et dénominations commerciales voir la note dans l'index.



Beziehen auf die marke und handelsname sehen sie die notiz im Impressum.  
 Relativamente às marcas e denominações comerciais, ver aviso legal.  
 Jeśli chodzi o znaki i nazwy handlowe, patrz Informacje prawne.







FOR: UNION®

503 UN-28I	581 UN-35I	901 UN-35D	UN-8I	UN-8D	UN-9I	UN-9D
574 UN-29I	582 UN-36I	902 UN-36D				
575 UN-30I	583 UN-37I	903 UN-37D				
576 UN-31I	584 UN-38I	904 UN-38D				
577 UN-32I	585 UN-39I	905 UN-39D				
578 UN-33I	586 UN-40I	906 UN-40D				
579 UN-34I	587 UN-41I	907 UN-41D				
	588 UN-42I	908 UN-42D				
	589 UN-43I	909 UN-43D				

FOR: UNION®

UN-10I	UN-10D	UN-45D	UN-46D	UN-47	UN-FK	UN-FS
		FOR: ONIUM®	FOR: JAGUAR®-VAUXHALL®	FOR: WBH®		

UNIVERSAL

TX-3D	TX-12	TX-13D	U-1I	U-1D	U-2I	U-2D
FOR: EURO SPEC®	FOR: FLOK®	FOR: EURO SPEC®			FOR: TECNO®	

UNIVERSAL

U-3I	U-3D	U-4I	U-4D	U-4AI	U-4AD	U-4GD	U-4JI	U-4JD
------	------	------	------	-------	-------	-------	-------	-------

UNIVERSAL

U-4TI	U-4TD	U-5I	U-5D	U-5I	U-5D	U-5AI	U-5AD	U-5BI	U-5BD
		FOR: ESAFE®-SIL®	FOR: ESAFE®-SIL®						

UNIVERSAL

U-5CI	U-5CD	U-5DI	U-5DD	U-5EI	U-5ED	U-5FI	U-5FD	U-5GD
-------	-------	-------	-------	-------	-------	-------	-------	-------

Concerning the marks and commercial denominations see legal warning.  
 Concerniente a las marcas y denominaciones comerciales ver aviso legal.  
 Marka eta izendapen komertzialiei dagokienez, ikus lege-oharra.  
 Concernant les marques et dénominations commerciales voir la note dans l'index.

**JMA** Opening the future

**JMA** Opening the future

Beziehen auf die Marke und Handelsname sehen Sie die Notiz im Impressum.  
 Relativamente às marcas e denominações comerciais, ver aviso legal.  
 Jeśli chodzi o znaki i nazwy handlowe, patrz Informacje prawne.

UNIVERSAL

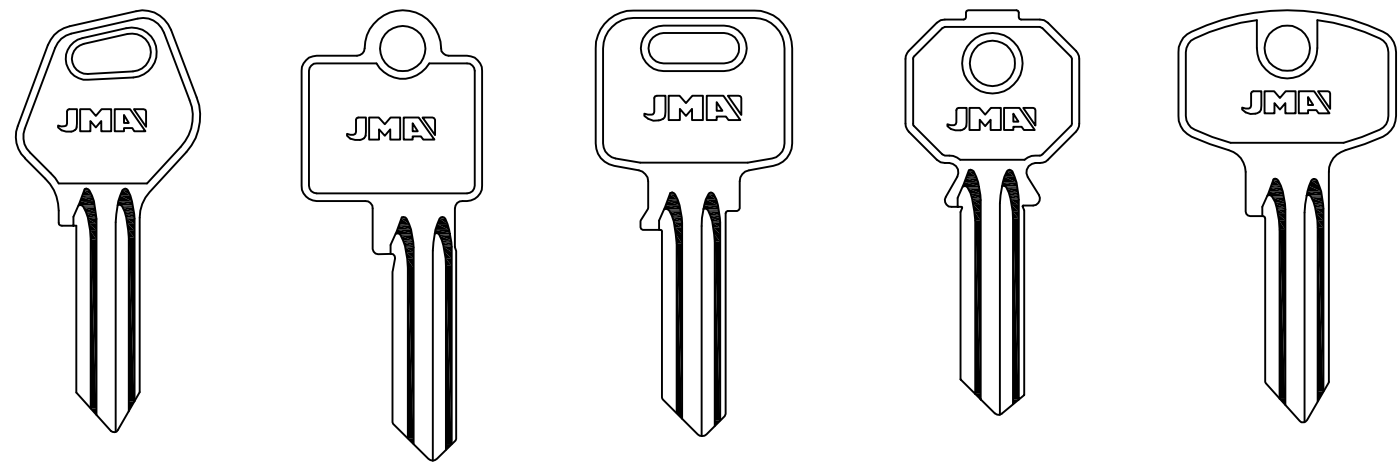

U-5JI U-5JD U-5KI U-5KD U-5MI U-5MD U-5PI U-5PD U-5QI U-5QD

UNIVERSAL

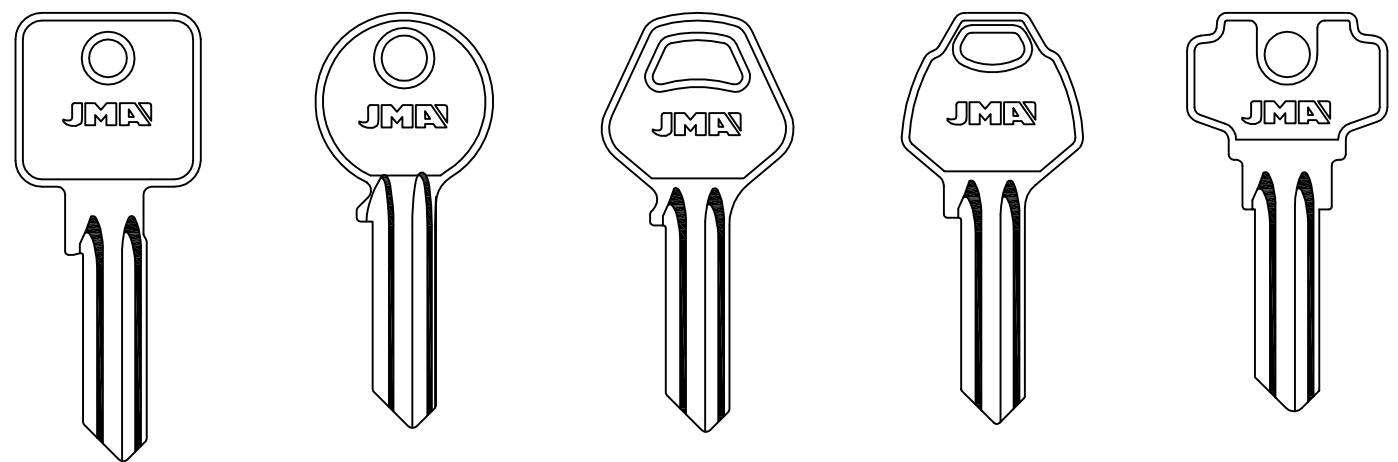

U-5SI U-5SD U-5SP U-5DSP U-5TI U-5TD U-5VI U-5VD U-5XI U-5XD

UNIVERSAL

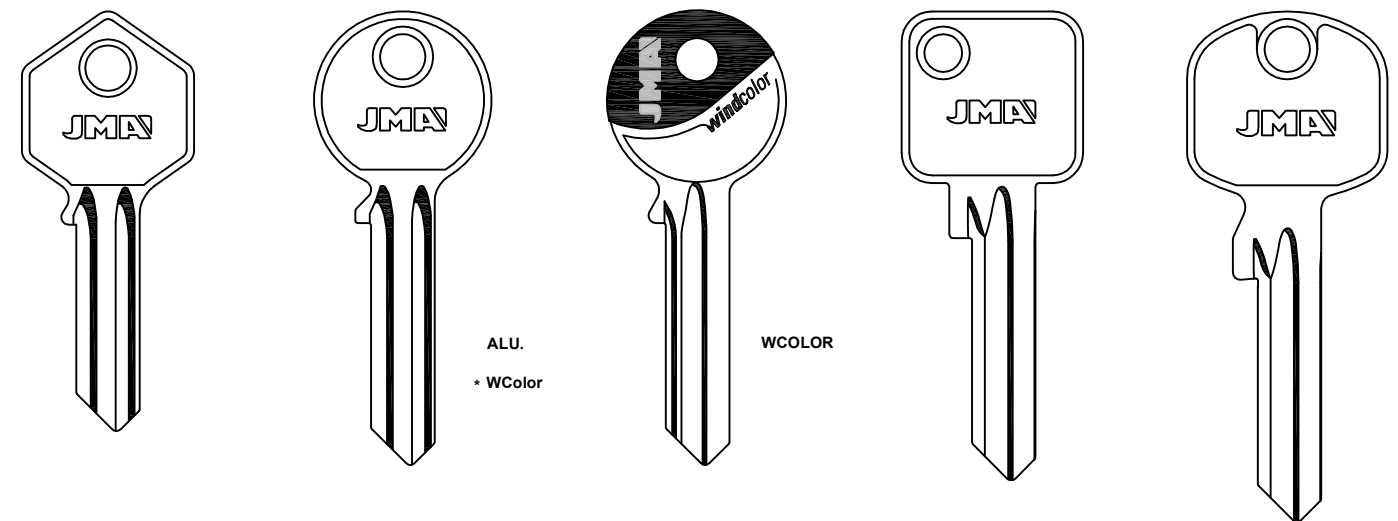

U-5YI U-5YD U-6I U-6D U-6BD U-6GD

UNIVERSAL

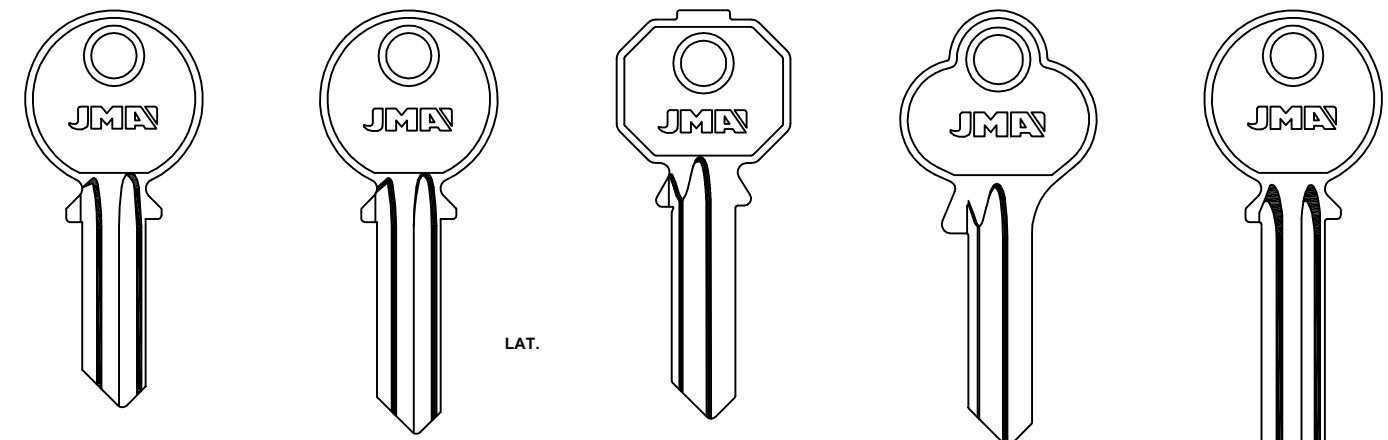

U-7 U-7D U-8 U-8D U-8PD U-8TD U-9 U-9D

UNIVERSAL

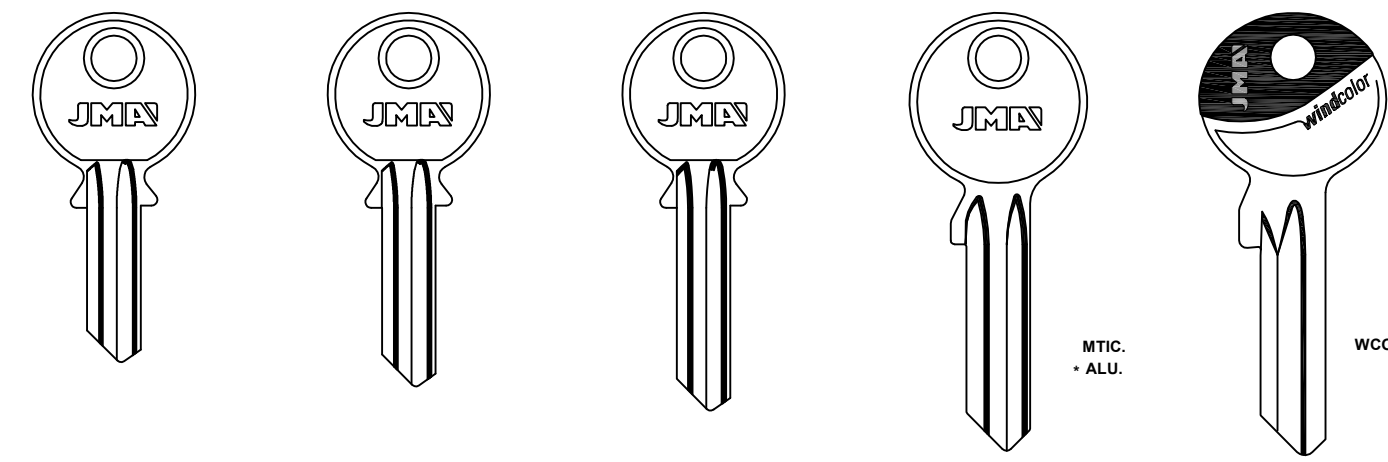

U-10I U-10D U-13I U-13D U-14I U-14D U-15 U-15D U-15D

FOR: GIESSE TVO-3D

TVO-2D

UNIVERSAL

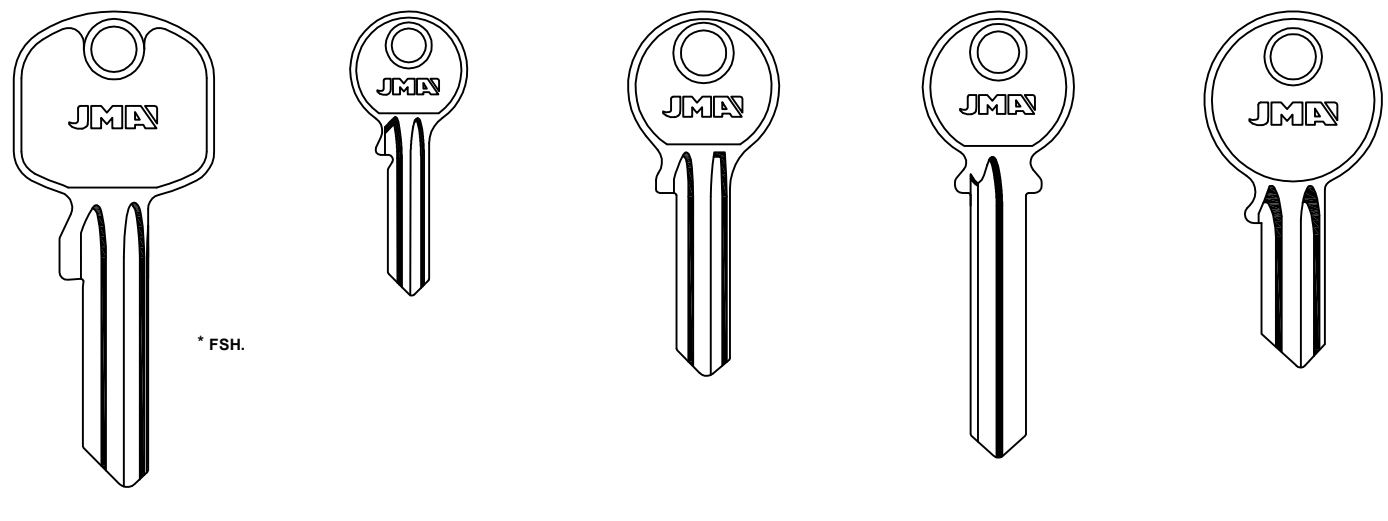

U-15GI U-15GD U-16 U-16D U-17 U-17D U-18D U-19 U-19D

TVO-4D

FOR: CISA LOGO

Concerning the marks and commercial denominations see legal warning.  
 Concerniente a las marcas y denominaciones comerciales ver aviso legal.  
 Marka eta izendapen komertzialiei dagokienez, ikus lege-oharra.  
 Concernant les marques et denominations commerciales voir la note dans l'index.

**JMA** Opening the future

**JMA** Opening the future

Beziehen auf die marke und handelsname sehen sie die notiz im Impressum.  
 Relativamente às marcas e denominações comerciais, ver aviso legal.  
 Jeśli chodzi o znaki i nazwy handlowe, patrz Informacje prawne.

UNIVERSAL

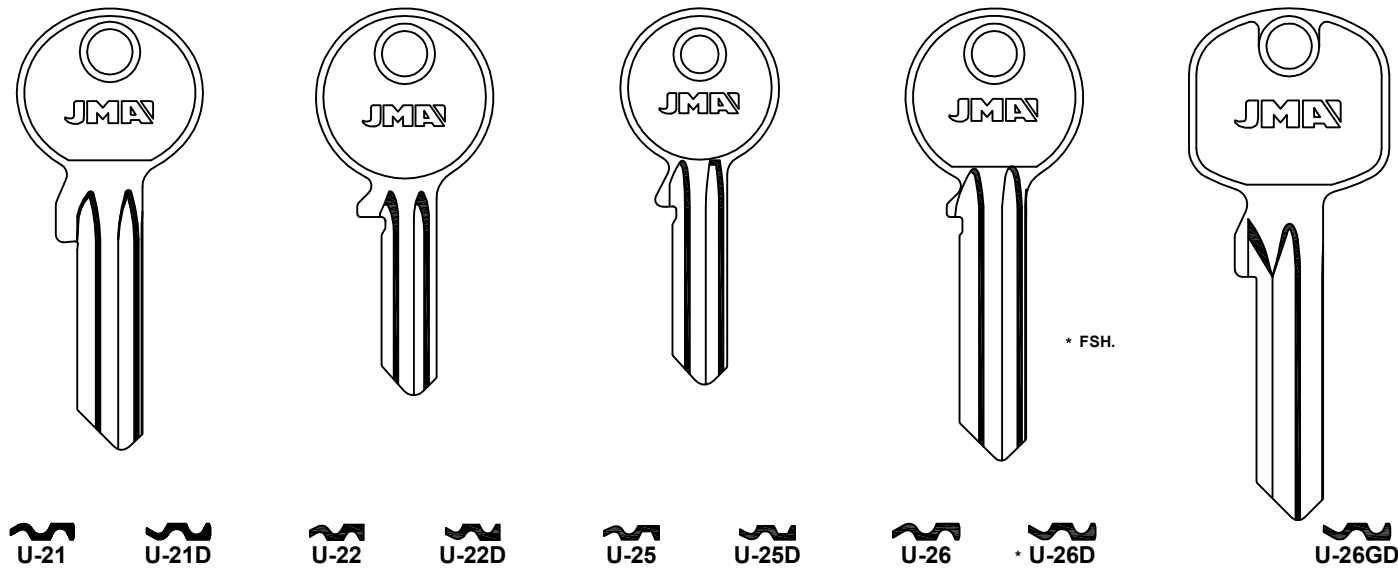

FOR: URBIS®

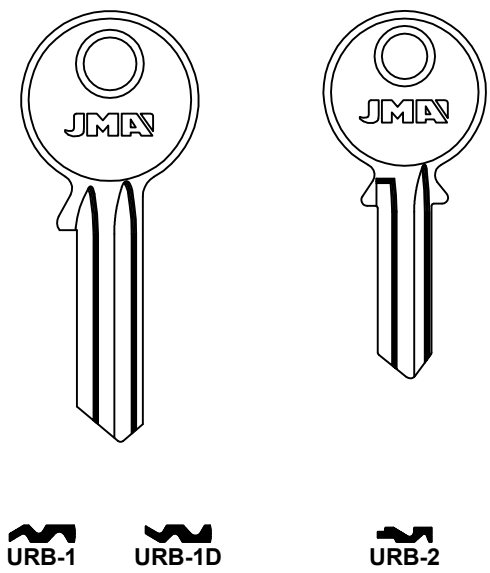

FOR: URKO®

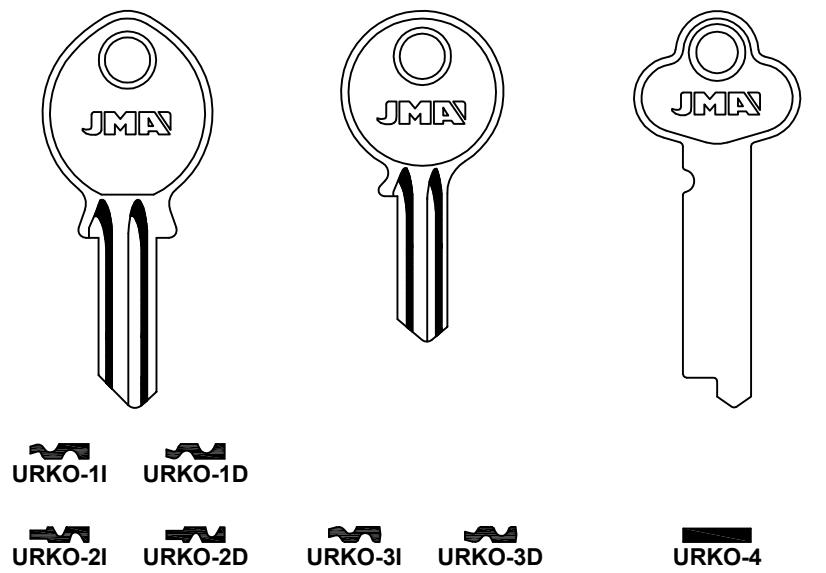

FOR: VACHETTE®

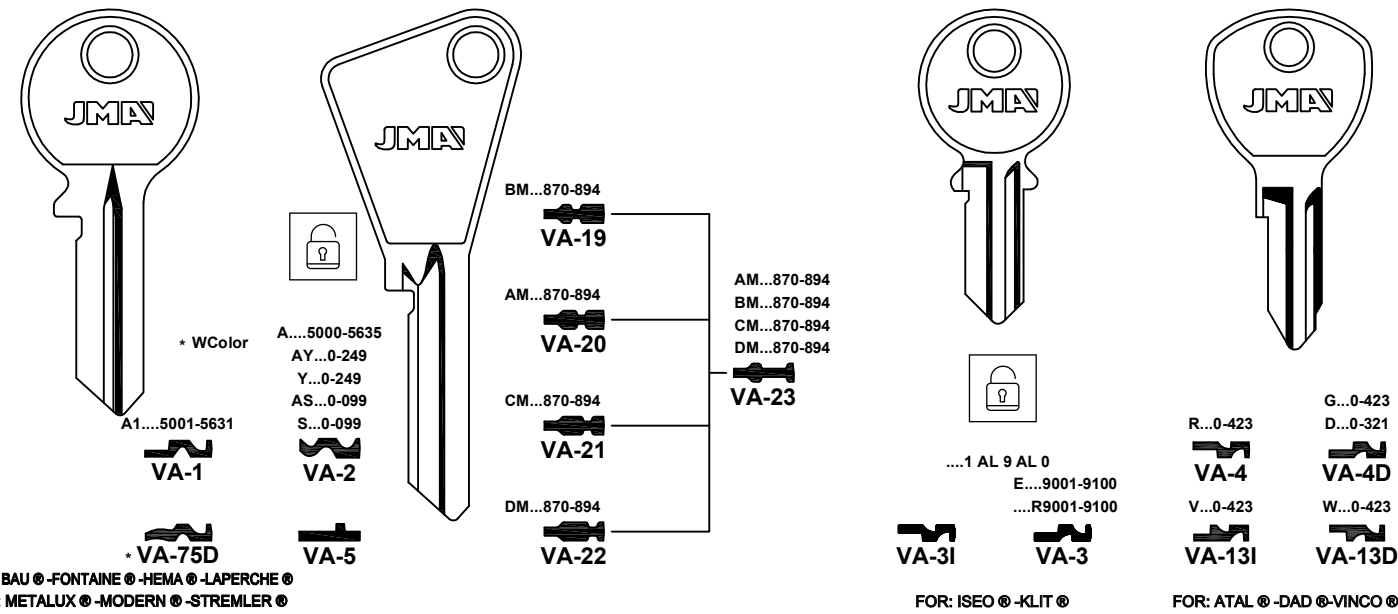

FOR: VACHETTE®

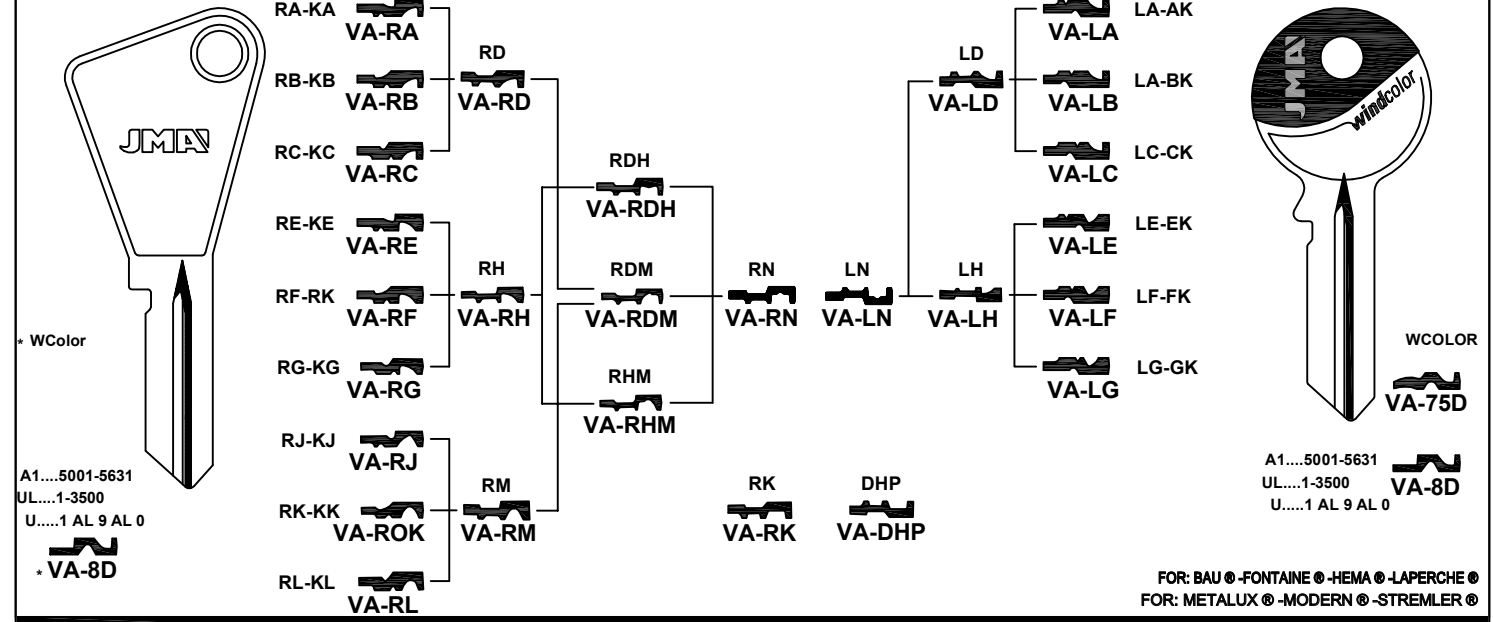

FOR: VACHETTE®

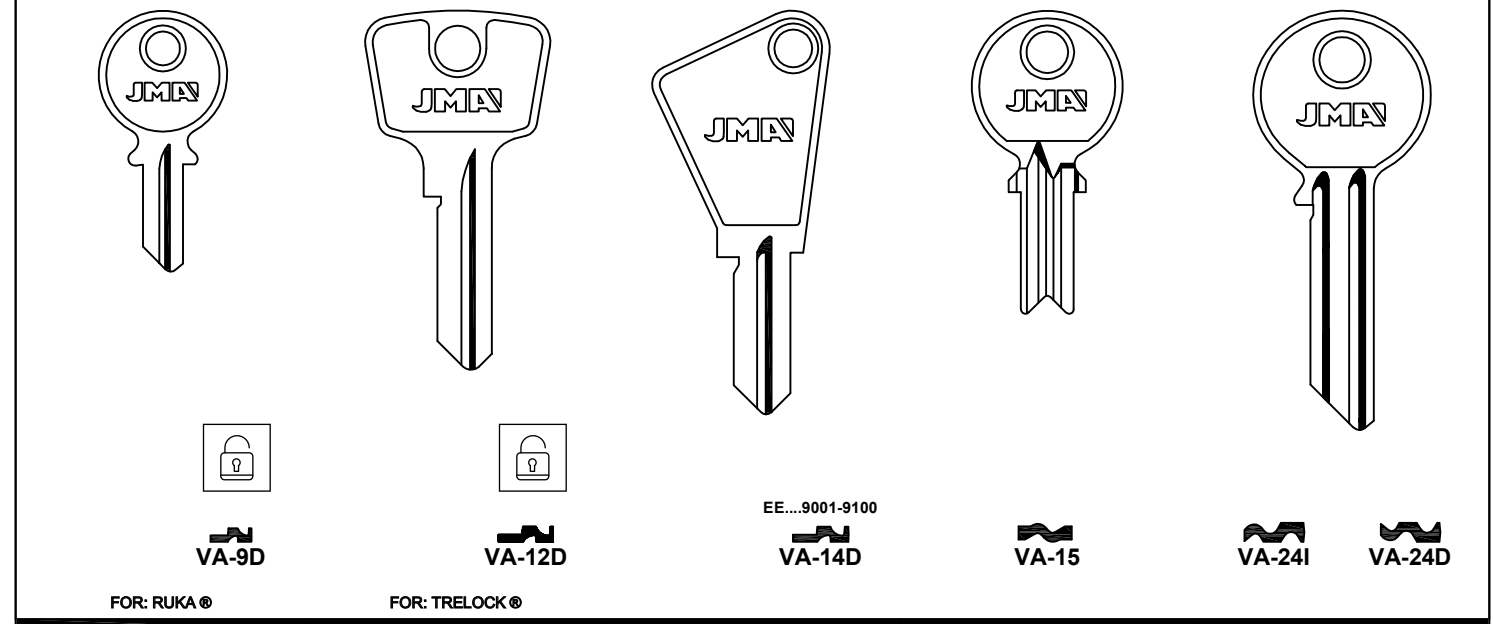

FOR: VACHETTE®

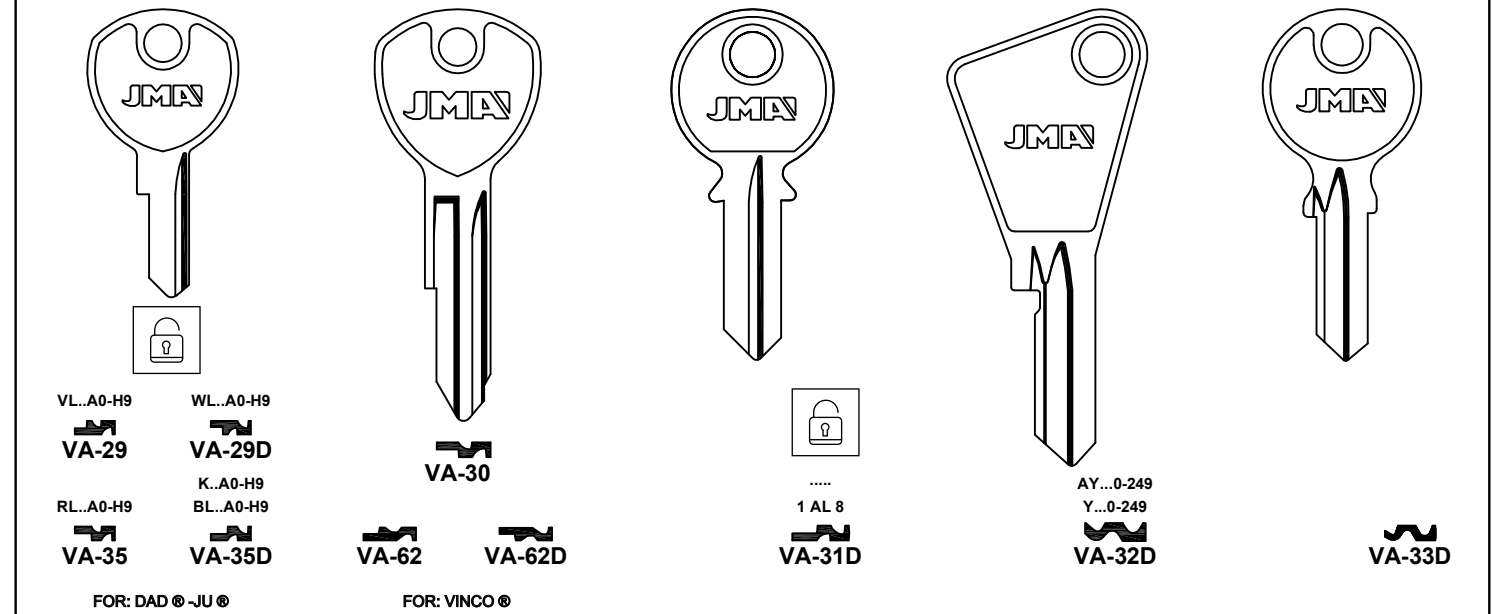

Concerning the marks and commercial denominations see legal warning.  
 Concerniente a las marcas y denominaciones comerciales ver aviso legal.  
 Marka eta izendapen komertzialiei dagokienez, ikus lege-oharra.  
 Concernant les marques et denominations commerciales voir la note dans l'index.

**JMA** Opening the future

**JMA** Opening the future

Beziehen auf die marke und handelsname sehen sie die notiz im Impressum.  
 Relativamente às marcas e denominações comerciais, ver aviso legal.  
 Jeśli chodzi o znaki i nazwy handlowe, patrz Informacje prawne.

FOR: VACHETTE®

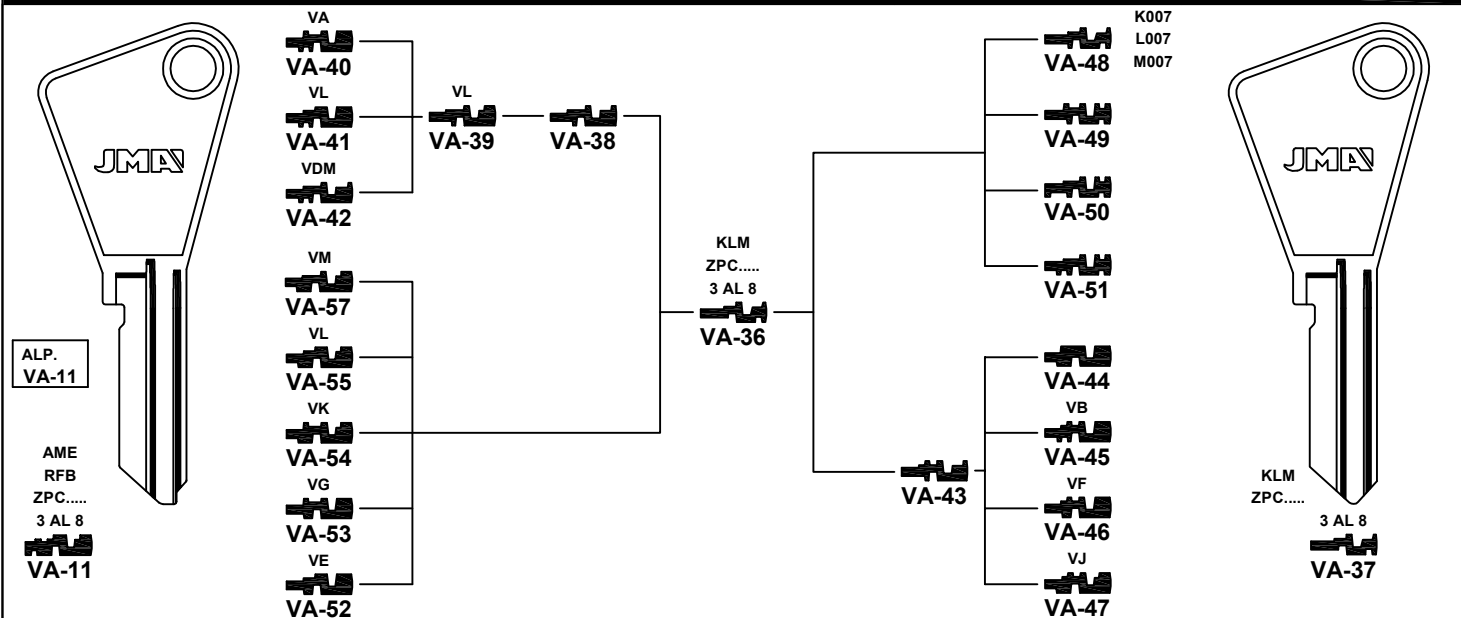

FOR: VACHETTE®

VARIOS

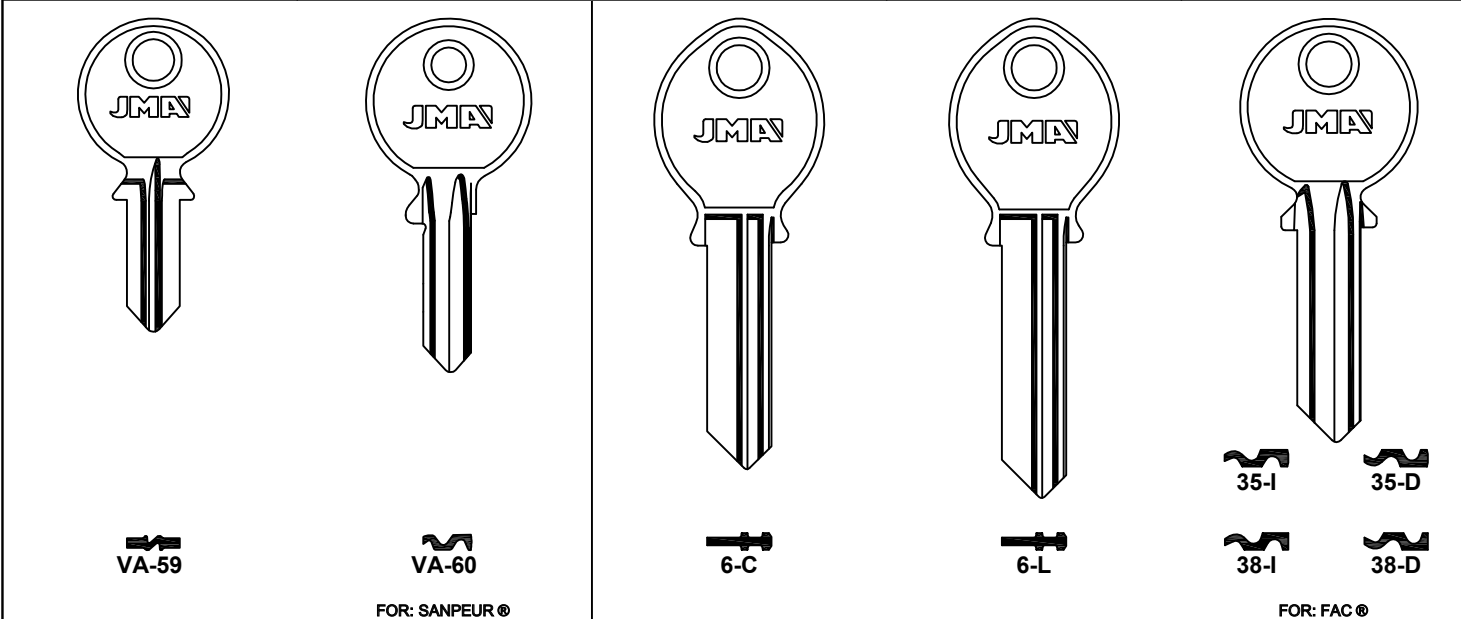

VARIOS

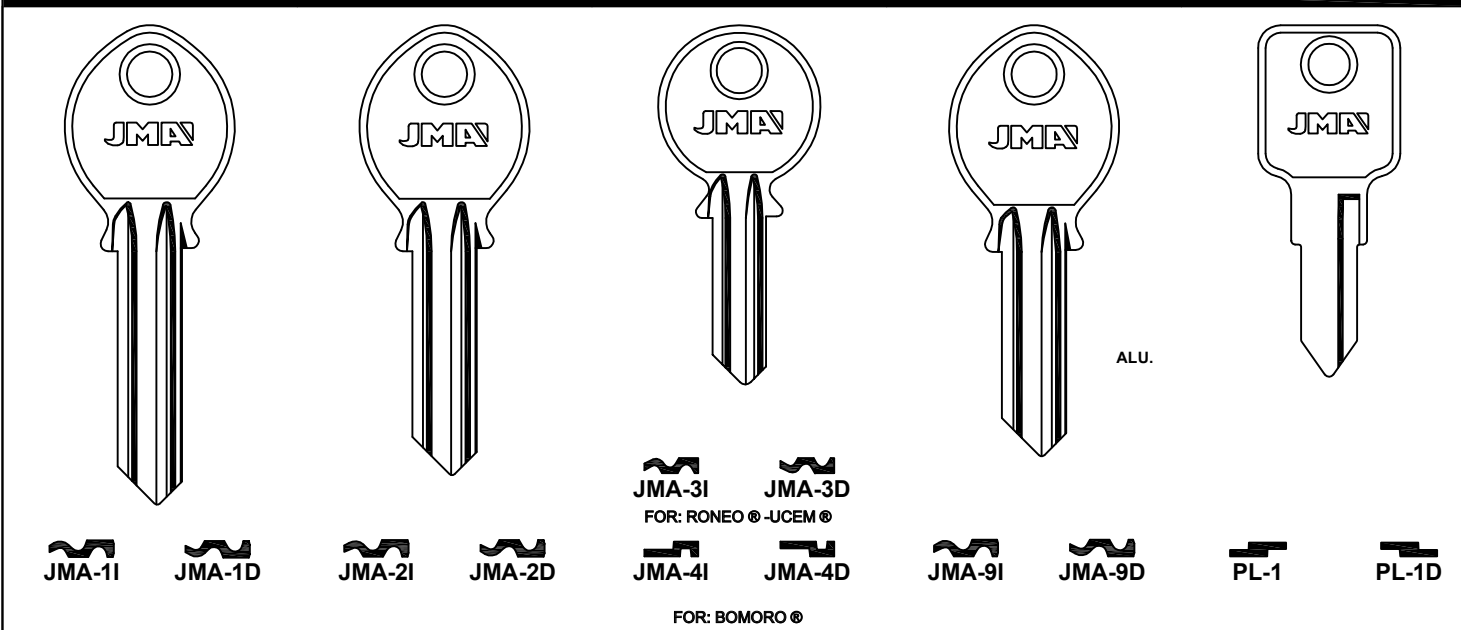

FOR: VBH®

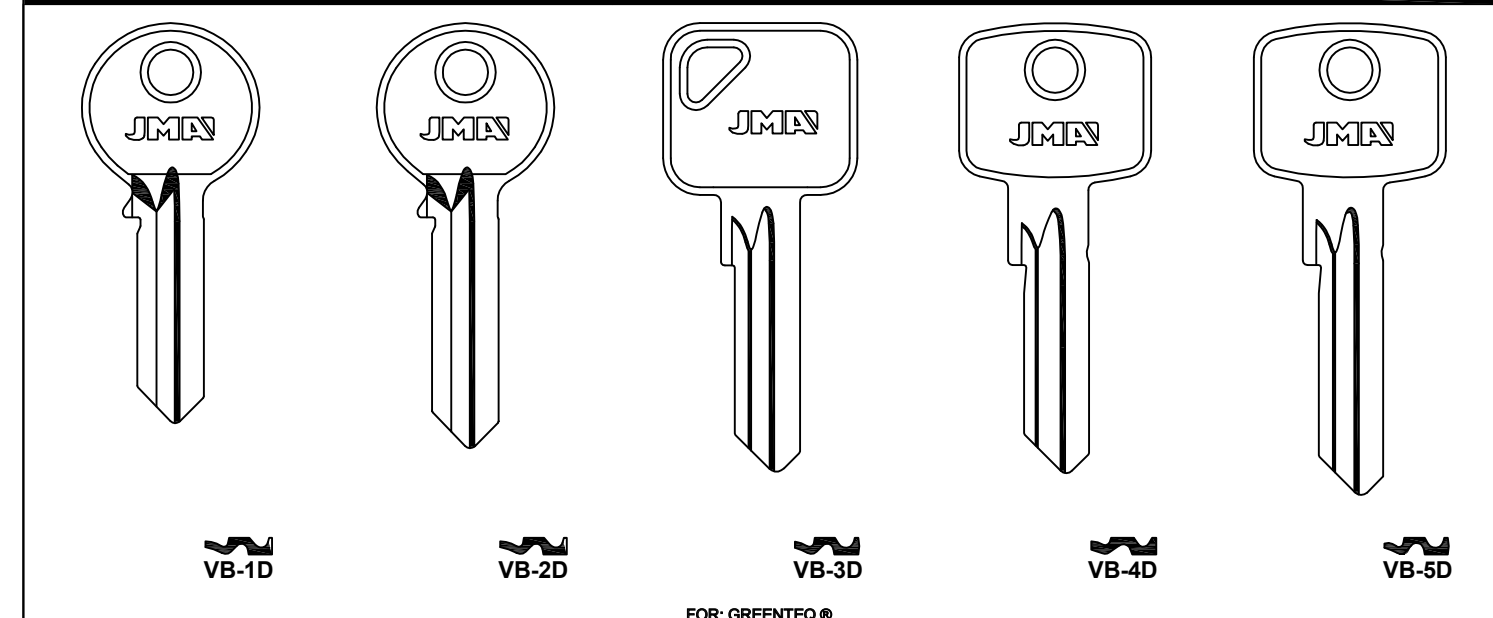

FOR: VEGA®

FOR: VENDI®

FOR: VGF VILLATORE®

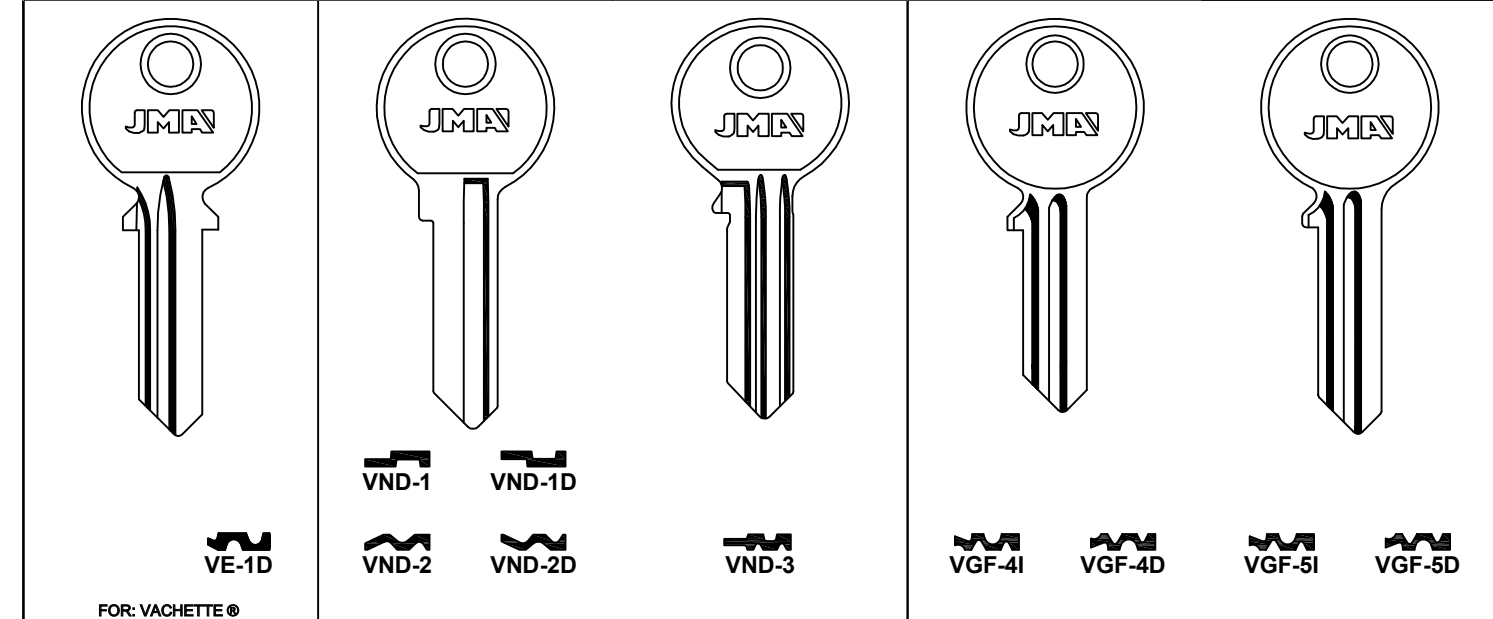

FOR: VING®

FOR: VIRO®

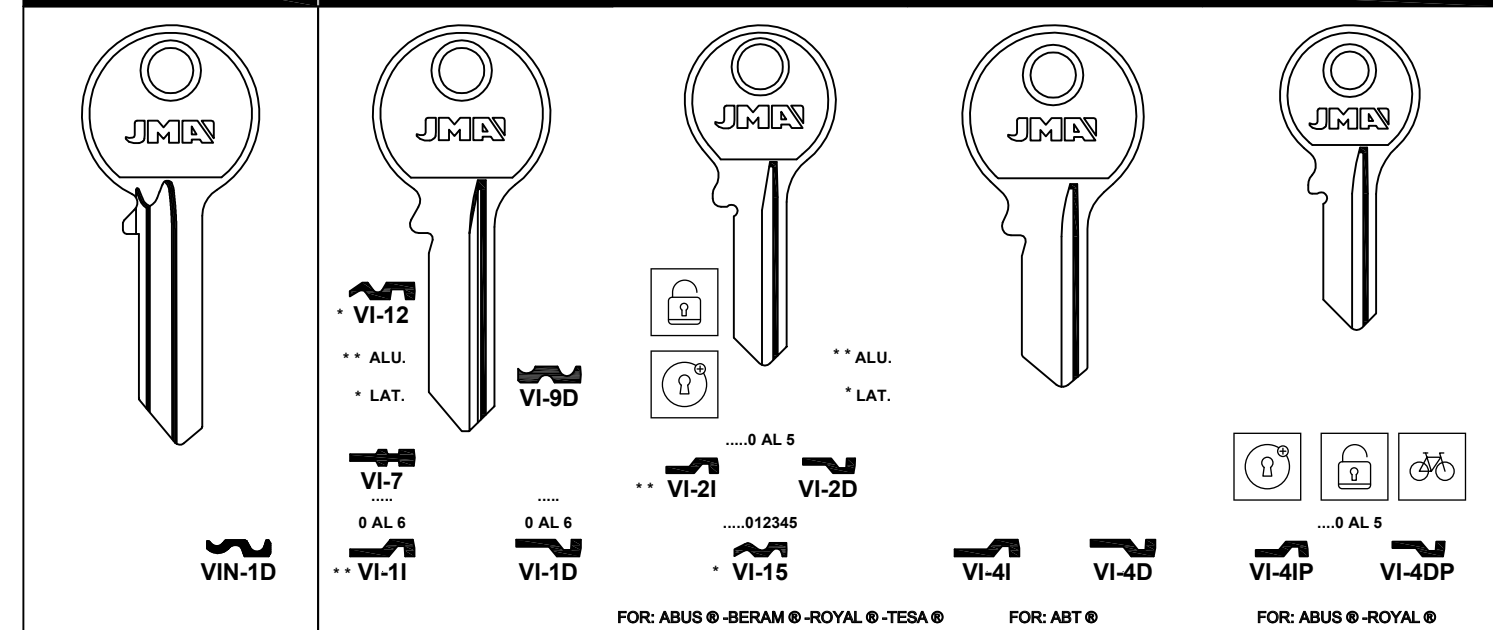

Concerning the marks and commercial denominations see legal warning.  
 Concerniente a las marcas y denominaciones comerciales ver aviso legal.  
 Marka eta izendapen komertzialiei dagokienez, ikus lege-oharra.  
 Concernant les marques et dénominations commerciales voir la note dans l'index.

**JMA** Opening the future

**JMA** Opening the future

Beziehen auf die marke und handelsname sehen sie die notiz im Impressum.  
 Relativamente às marcas e denominações comerciais, ver aviso legal.  
 Jeśli chodzi o znaki i nazwy handlowe, patrz Informacje prawne.



FOR: VIRO®

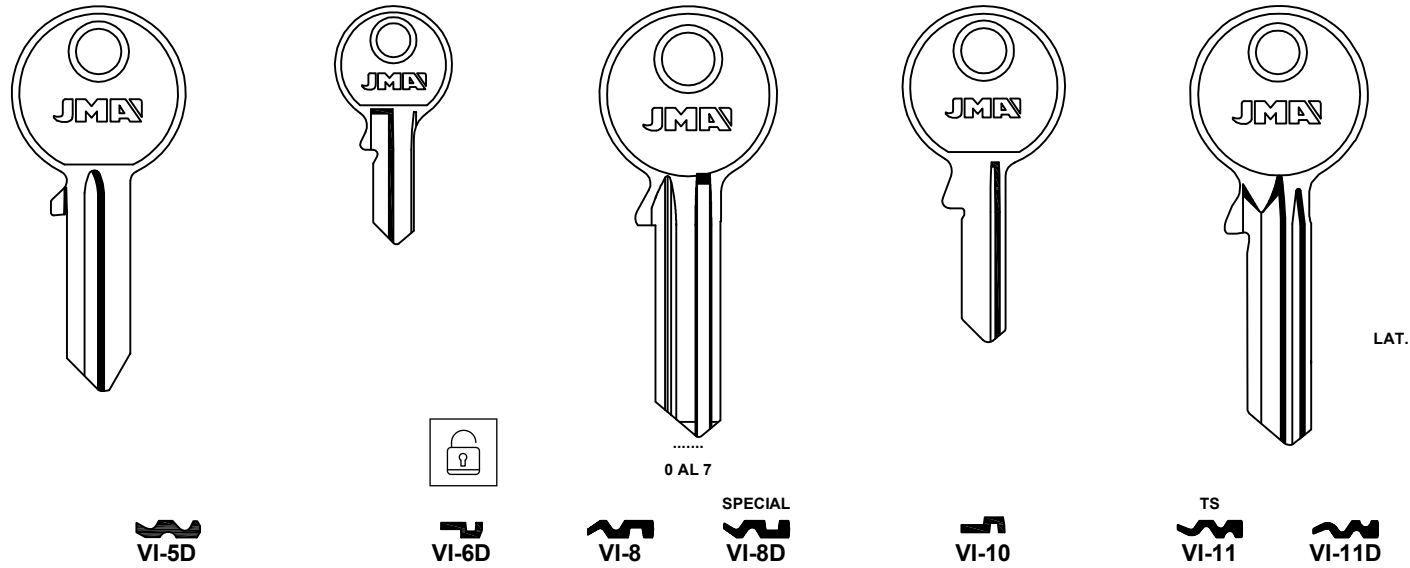

FOR: ABT®      FOR: ABUS®-BURG®      0 AL 7      SPECIAL VI-8D      VI-10      TS VI-11      VI-11D

FOR: VIRO®

FOR: VOLGOGRAD®

FOR: VOLKOVYSK®

FOR: WALLY®

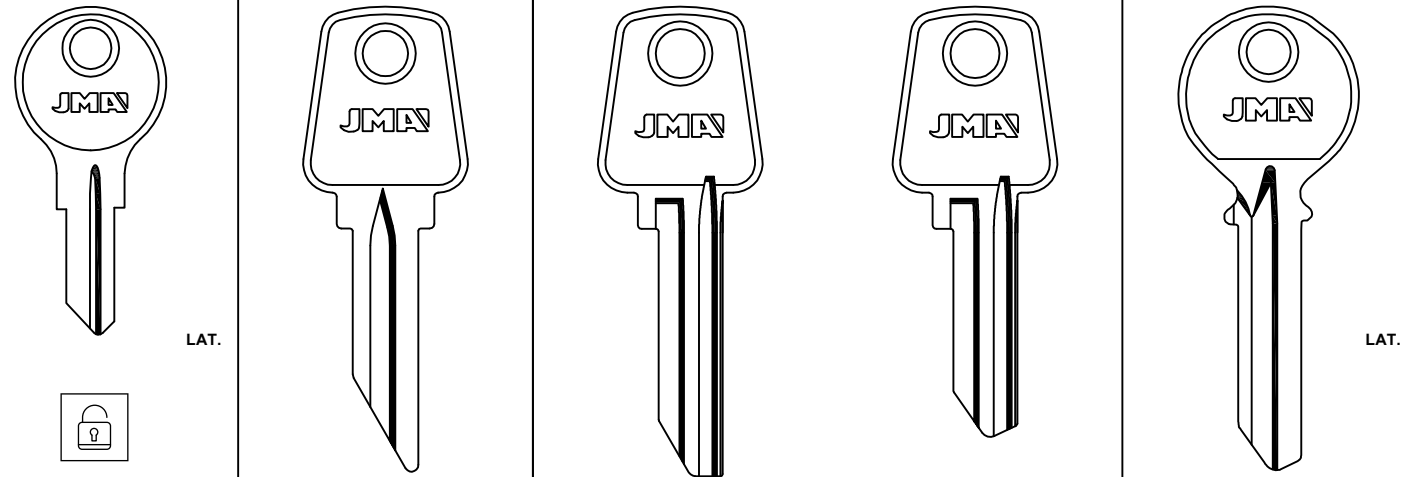

FOR: FAI®      VI-16D      VG-1D      VLK-1      VLK-2      WA-1D

FOR: WALLY®

FOR: WALRUS®

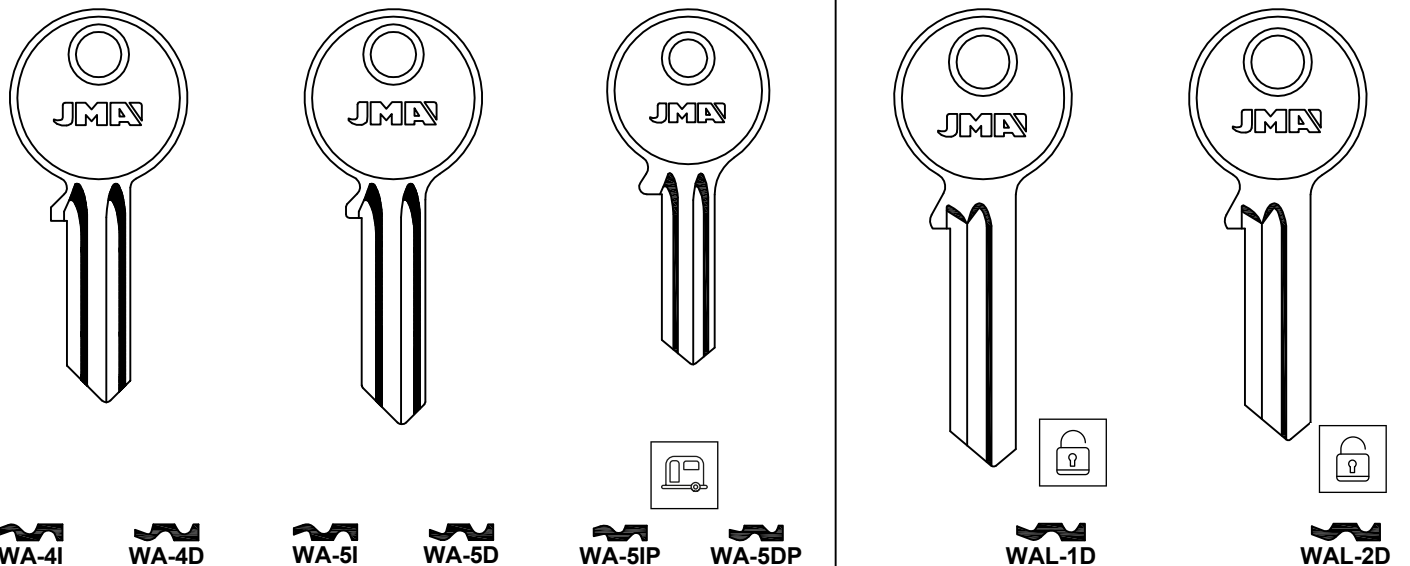

WA-4I      WA-4D      WA-5I      WA-5D      WA-5IP      WA-5DP      WAL-1D      WAL-2D      FOR: MOREAUX®

FOR: WEBER®

FOR: WEBSTER®

FOR: WEISER®

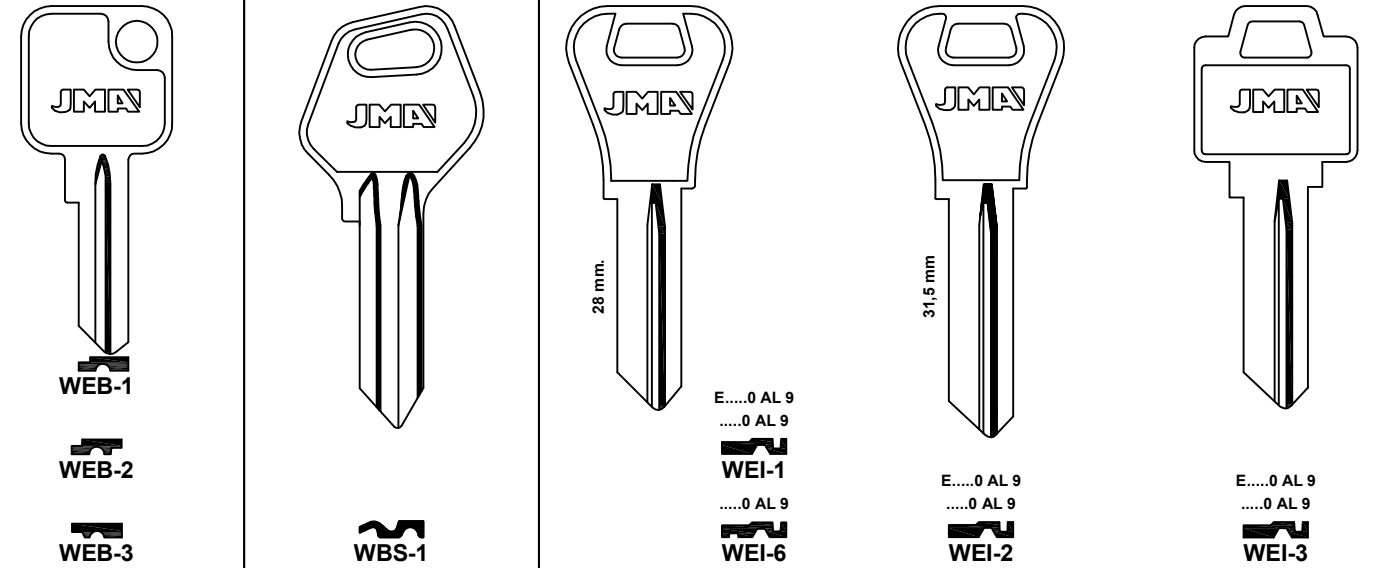

FOR: WECO®      FOR: KAWE®      FOR: FALCON®-FICHET®      FOR: IDEAL SECURITY®

FOR: WEISER®

FOR: WELKA®

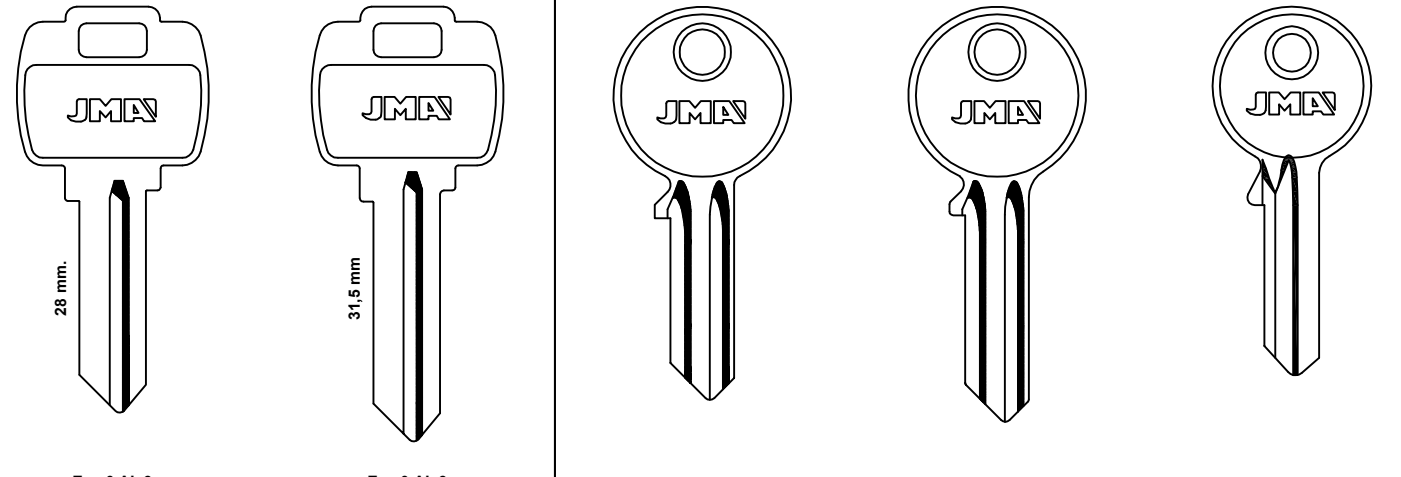

FOR: FALCON®      FOR: FALCON®      WE-4I      WE-4D      WE-5I      WE-5D      WE-6D

FOR: WESLOCK®

FOR: WEST LOCK®

FOR: WHITCO®

FOR: WILKA®

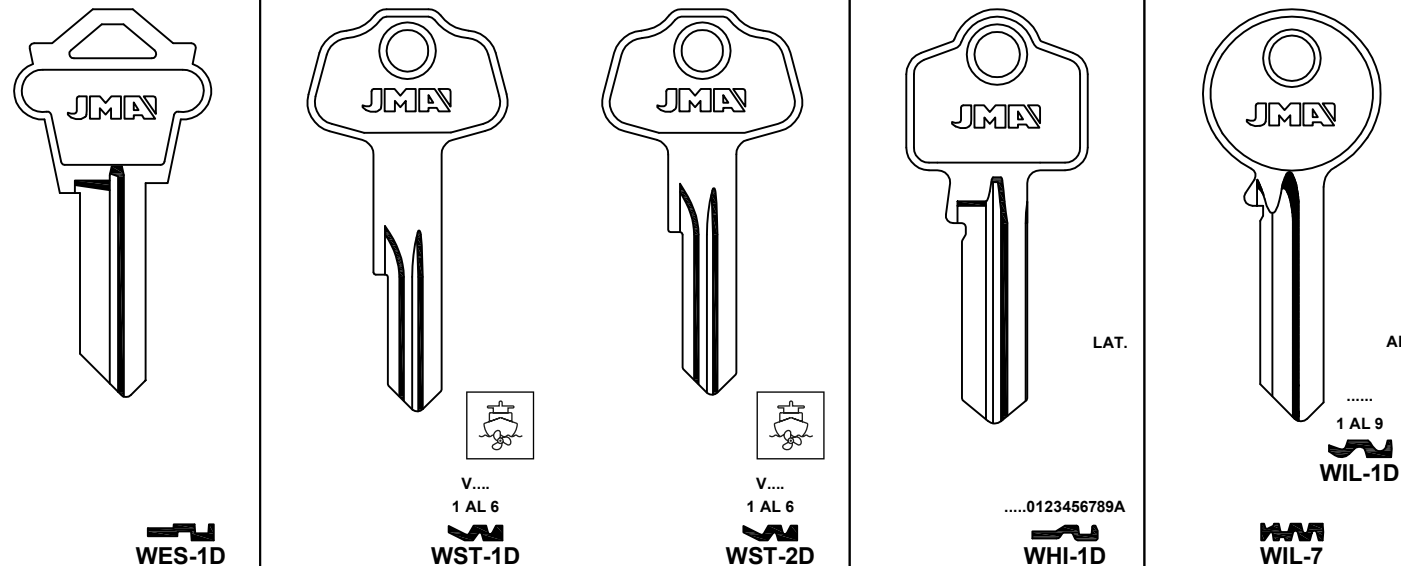

WES-1D      V... 1 AL 6 WST-1D      V... 1 AL 6 WST-2D      .....0123456789A WHI-1D      ..... 1 AL 9 WIL-7      FOR: JORE®-WIGRO®

Concerning the marks and commercial denominations see legal warning.  
 Concerniente a las marcas y denominaciones comerciales ver aviso legal.  
 Marka eta izendapen komertzialiei dagokienez, ikus lege-oharra.  
 Concernant les marques et dénominations commerciales voir la note dans l'index.

FOR: WILKA®

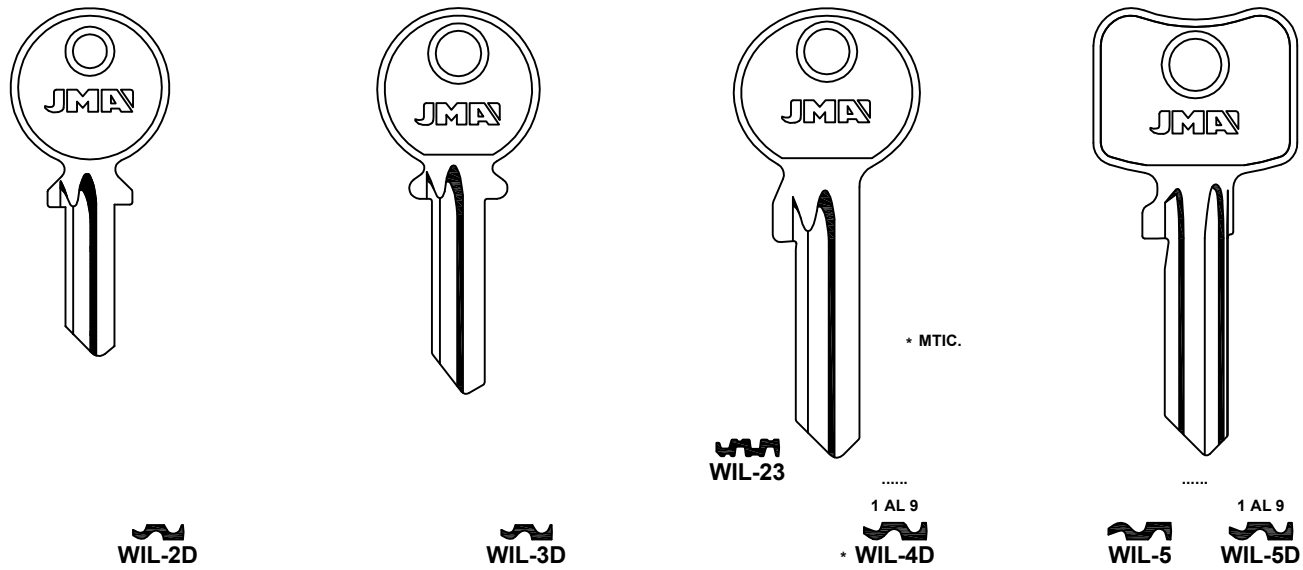

WIL-2D

WIL-3D

WIL-23

1 AL 9  
WIL-4D

WIL-5

1 AL 9  
WIL-5D

FOR: CFP®-GBS®

FOR: JORE®-WIGRO®

FOR: WILKA®

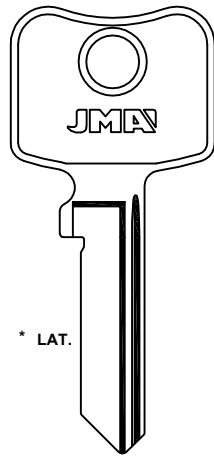

\* LAT.



FOR: WILKA®

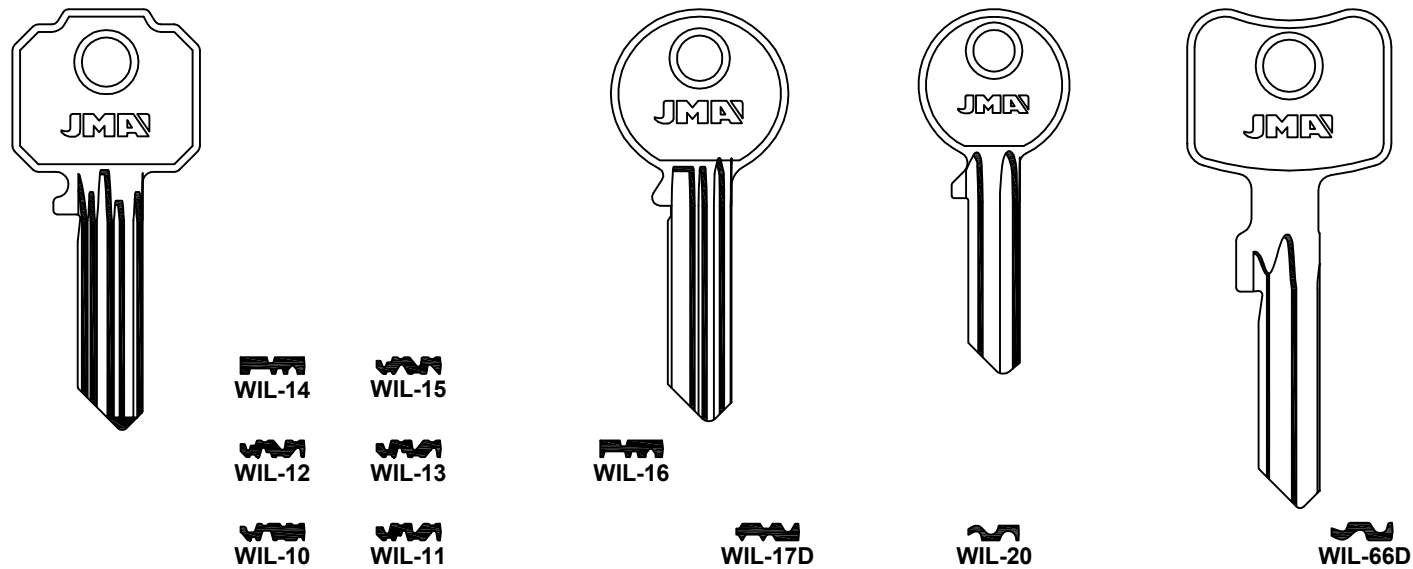

WIL-14

WIL-15

WIL-12

WIL-13

WIL-16

WIL-10

WIL-11

WIL-17D

WIL-20

WIL-66D

FOR: BIFFAR®-BEFA®

FOR: WINKHAUS®

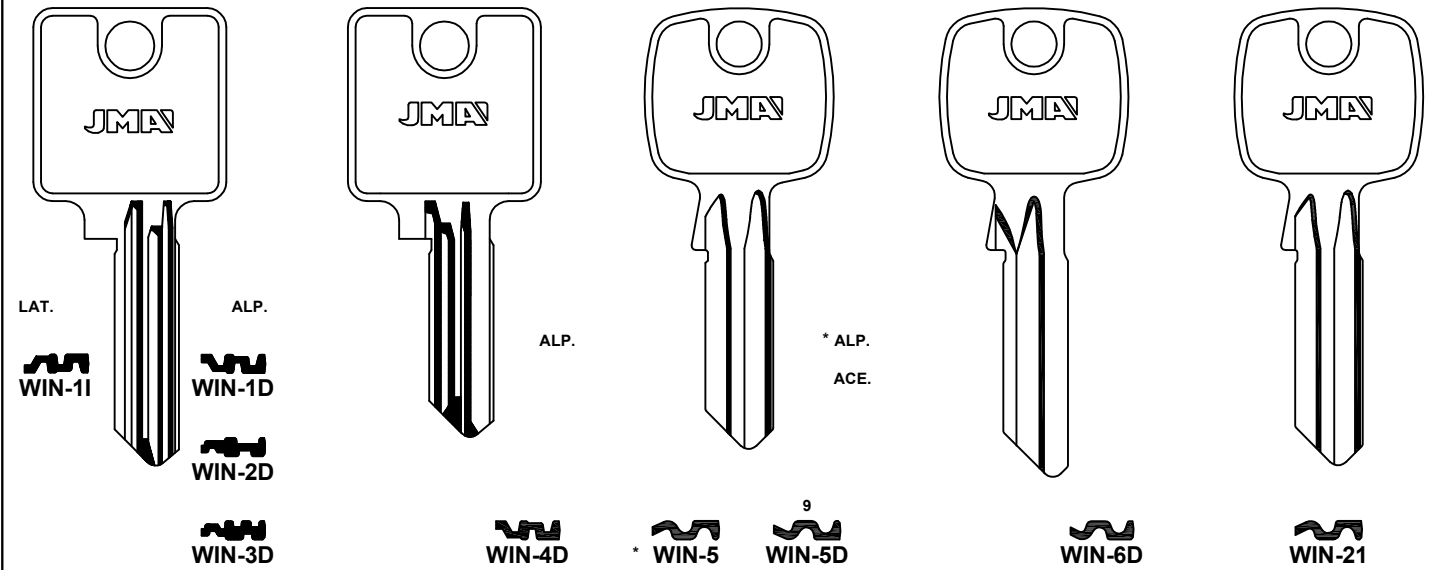

LAT.

WIN-11

ALP.

WIN-1D

WIN-2D

ALP.

WIN-3D

WIN-4D

\* ALP.

ACE.

WIN-5

9  
WIN-5D

WIN-6D

WIN-21

FOR: AZBE®

FOR: AZBE®

FOR: WINKHAUS®

FOR: WINLOCK®

FOR: WIREROPE®

FOR: WMS®

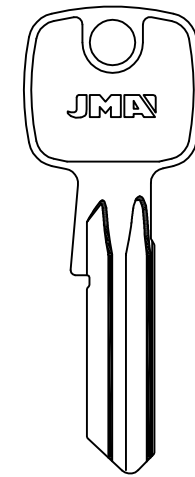

WIN-22

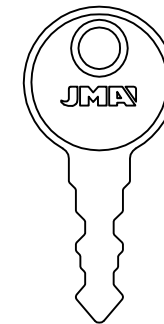

WNC-1

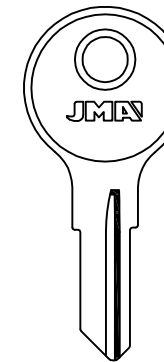

WIR-1

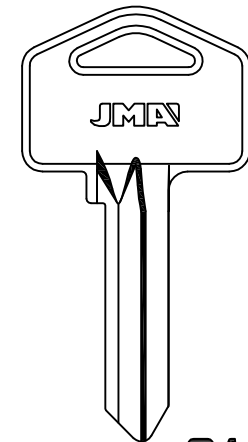

WM-1D

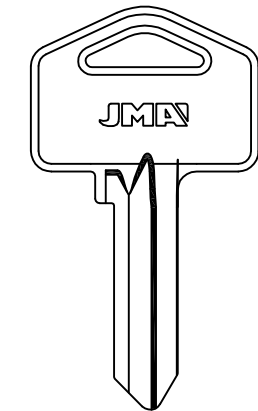

WM-2D

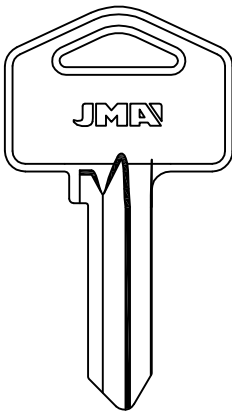

WM-3D

FOR: WMS®

FOR: WT®

FOR: YALE®

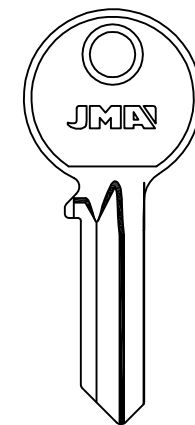

WM-4D

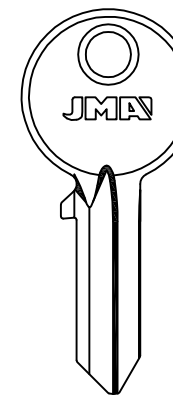

WM-5D

FOR: I.R.®-TITUS®

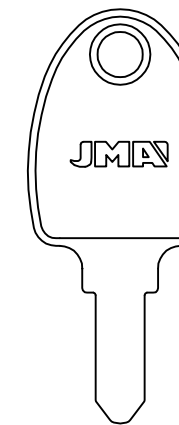

WT-1

LAT.

ALU.

ALU.

YA-1I

YA-1D

.....0 AL 9

YA-32D

FOR: WALE®

YA-2I

YA-2D

.....0 AL 9

YA-2I

YA-2D

Concerning the marks and commercial denominations see legal warning.  
 Concerniente a las marcas y denominaciones comerciales ver aviso legal.  
 Marka eta izendapen komertzialiei dagokienez, ikus lege-oharra.  
 Concernant les marques et denominations commerciales voir la note dans l'index.

FOR: YALE®

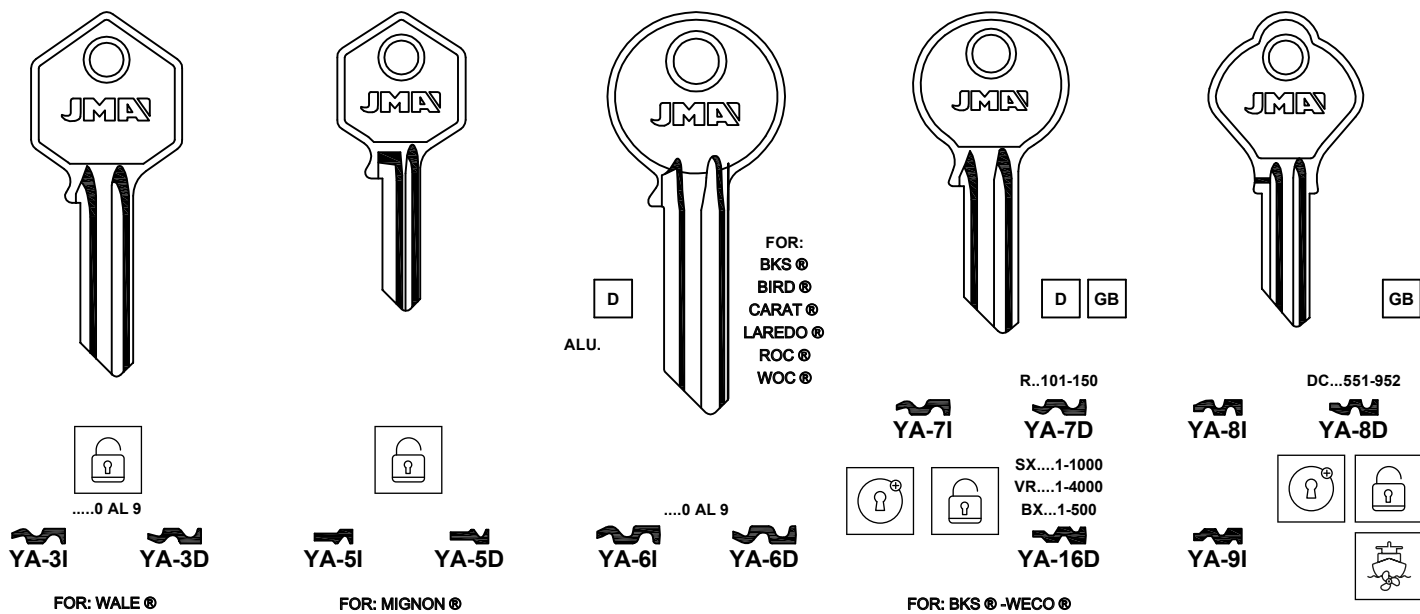

FOR: YALE®

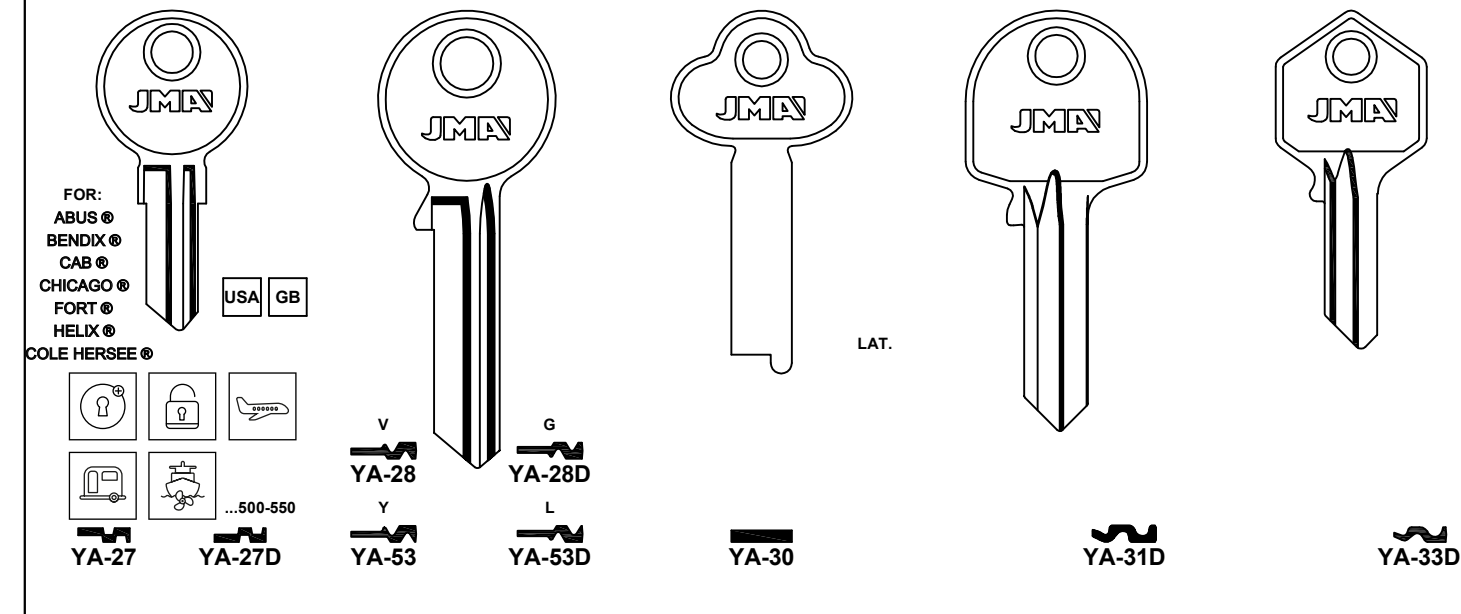

FOR: YALE®

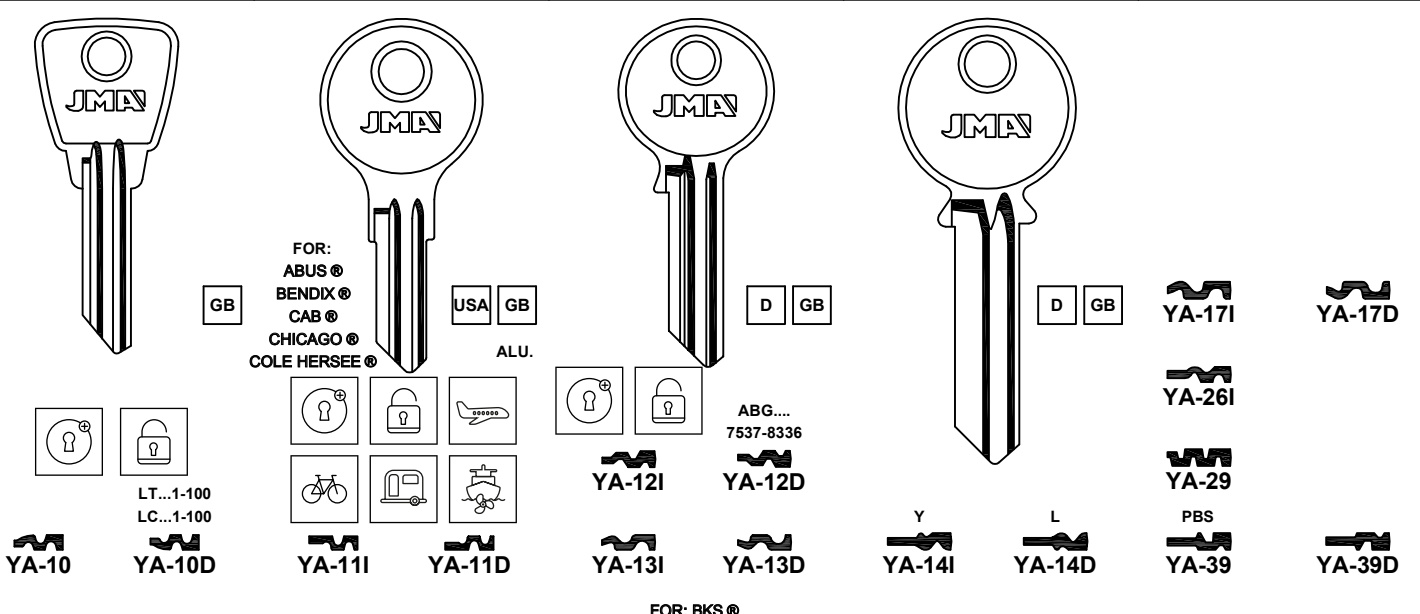

FOR: YALE®

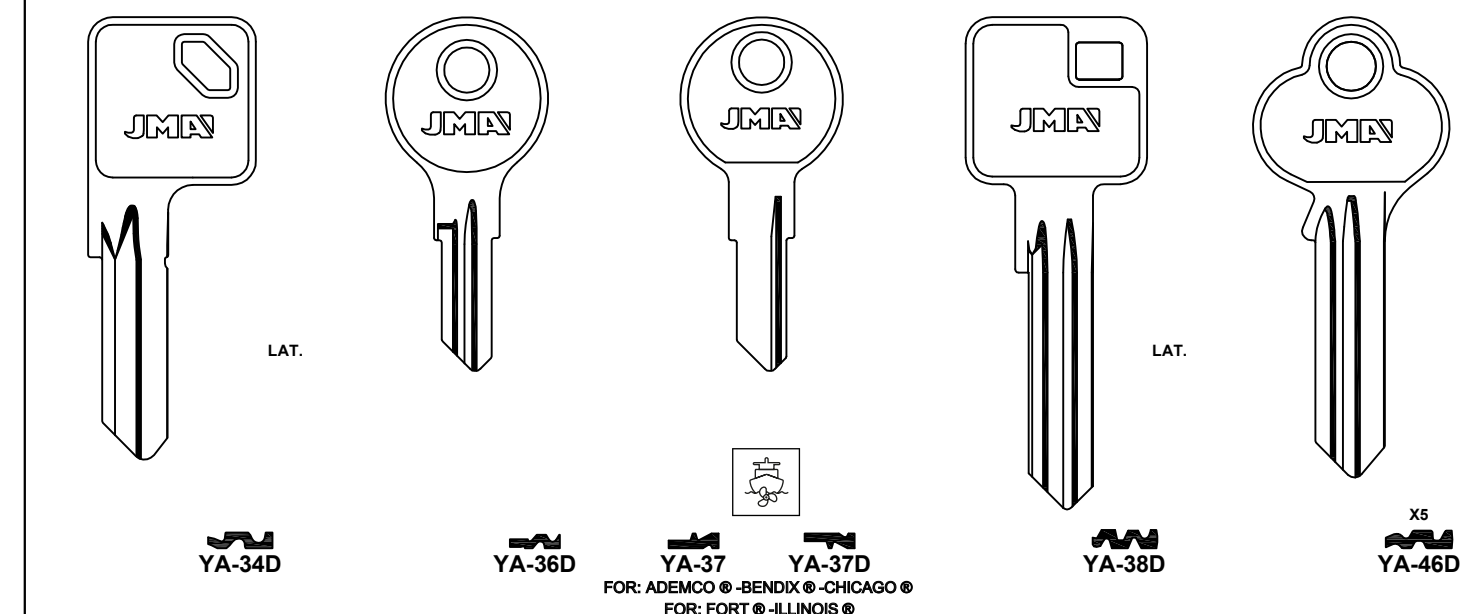

FOR: YALE®

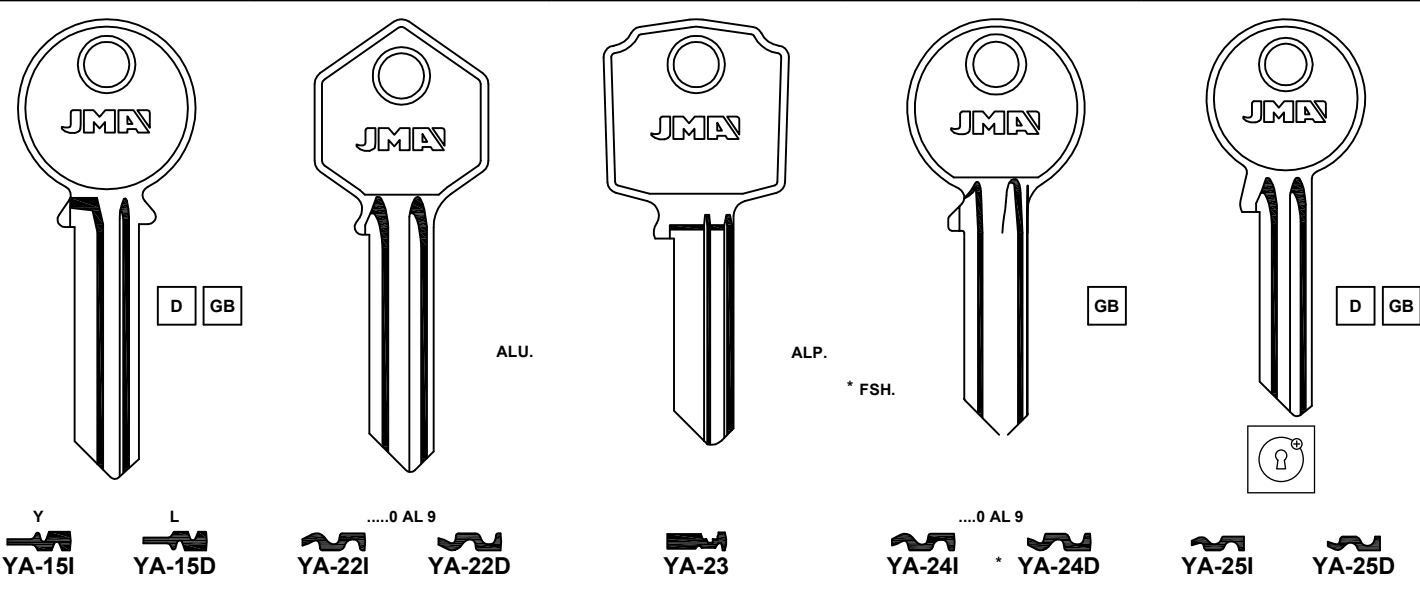

FOR: YALE®

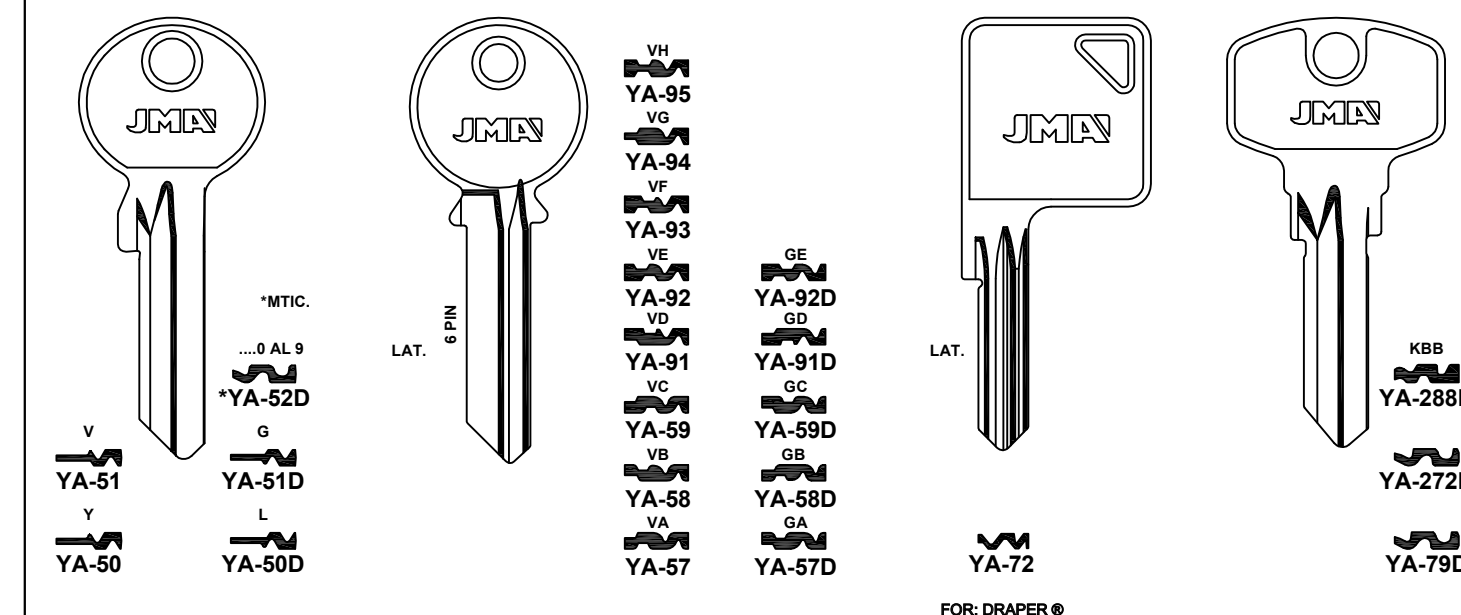

Concerning the marks and commercial denominations see legal warning.  
 Concerniente a las marcas y denominaciones comerciales ver aviso legal.  
 Marka eta izendapen komertzialiei dagokienez, ikus lege-oharra.  
 Concernant les marques et denominations commerciales voir la note dans l'index.



Beziehen auf die marke und handelsname sehen sie die notiz im Impressum.  
 Relativamente às marcas e denominações comerciais, ver aviso legal.  
 Jeśli chodzi o znaki i nazwy handlowe, patrz Informacje prawne.

FOR: YALE®

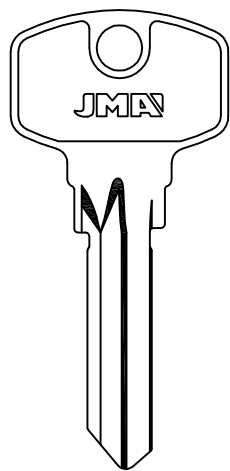

YA-85D

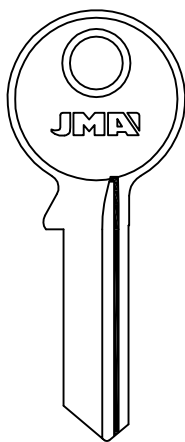

YA-88

FOR: ASSA ABLOY®

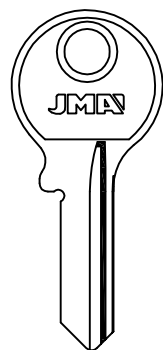

YA-89

FOR: ASSA ABLOY®

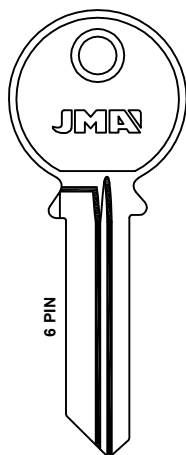

- LG YA-103D
- LF YA-102D
- LE YA-101D
- LD YA-100D
- LC YA-99D
- LB YA-98D
- LA YA-97D



LAT.

6 PIN

FOR: YALE®

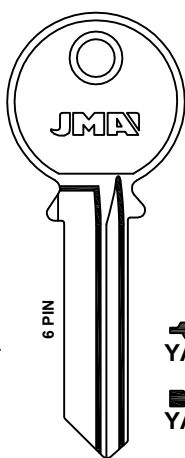

- YG YA-113
- YF YA-112
- YE YA-111
- YB YA-108

FOR: BKS®

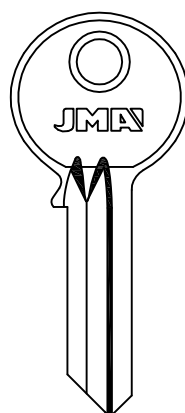

YA-142D

FOR: BKS®

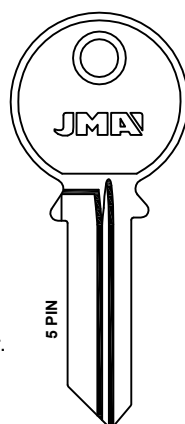

YA-186D

FOR: BKS®

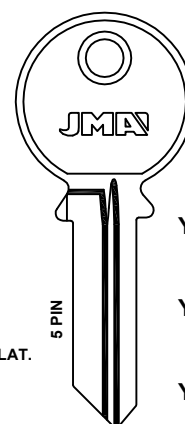

- LG YA-212D
- LE YA-210D
- LD YA-209D
- LC YA-208D
- LA YA-206D

LAT.

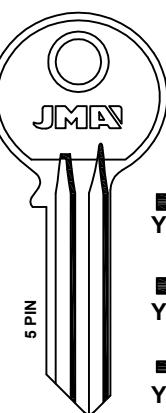

- VF YA-221
- VE YA-220
- VD YA-219
- VB YA-217
- VA YA-216

FOR: BKS®

FOR: YALE®

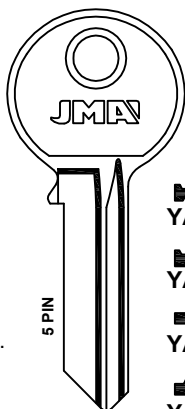

- YH YA-232
- YE YA-229
- YD YA-228
- YC YA-227
- YB YA-226
- YA YA-225

FOR: BKS®

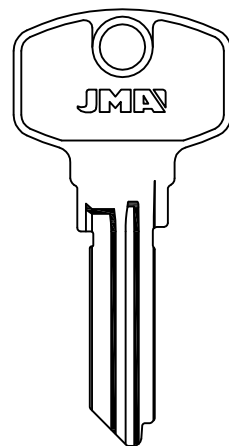

YA-273D

KTM

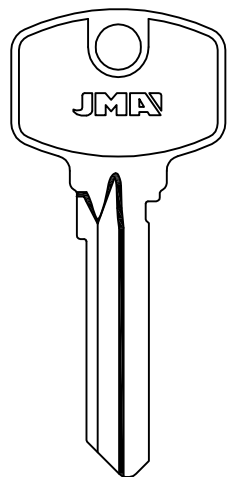

YA-287D

KBA

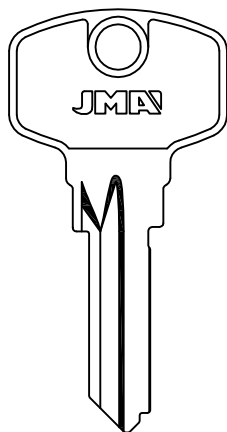

YA-300D

YL5-30D

FOR: YETI®

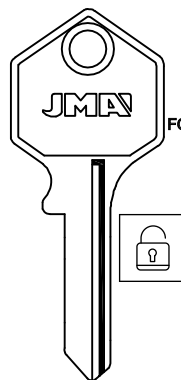

YET-1

YET-14

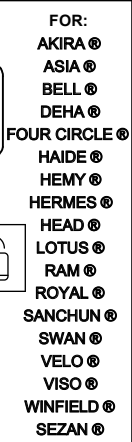

YET-1D

YET-14D

- FOR: AKIRA® ASIA® BELL® DEHA®
- FOUR CIRCLE® HAIDE® HEMY® HERMES® HEAD® LOTUS® RAM® ROYAL® SANCHUN® SWAN® VELO® VISO® WINFIELD® SEZAN®

FOR: YETI®

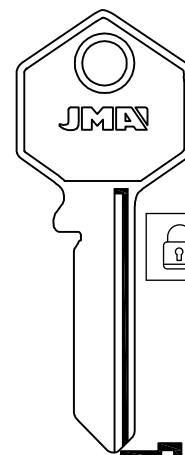

YET-2

YET-16

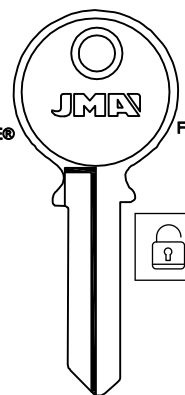

- FOR: AKIRA® ASIA® BELL® DEHA®
- FOUR CIRCLE® HAIDE® HEMY® HERMES® HEAD® LOTUS® RAM® ROYAL® SANCHUN® SWAN® VELO® VISO® WINFIELD® SEZAN®

YET-2D

YET-15

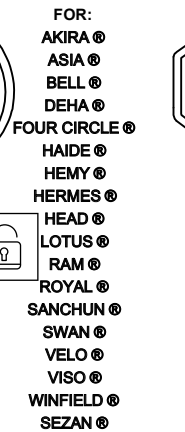

YET-3D

YET-4

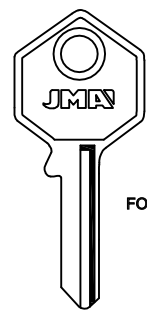

YET-4

YET-4D

- FOR: AKIRA® ASIA® BELL® DEHA®
- FOUR CIRCLE® HAIDE® HEMY® HERMES® HEAD® LOTUS® RAM® ROYAL® SANCHUN® SWAN® VELO® VISO® WINFIELD® SEZAN®

\* LAT.

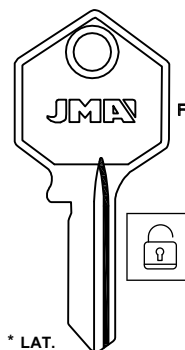

YET-5

YET-6

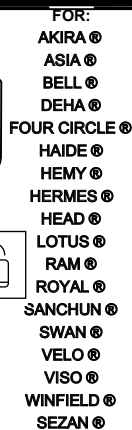

YET-5D

YET-6D

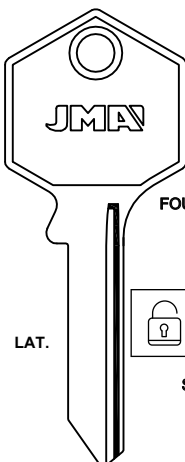

YET-7

YET-7D

- FOR: AKIRA® ASIA® BELL® DEHA®
- FOUR CIRCLE® HAIDE® HEMY® HERMES® HEAD® LOTUS® RAM® ROYAL® SANCHUN® SWAN® VELO® VISO® WINFIELD® SEZAN®

FOR: YETI®

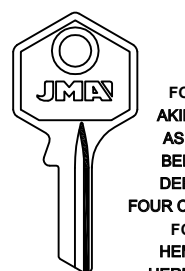

YET-8

YET-8D



YET-9

YET-9D

- FOR: AKIRA® ASIA® BELL® DEHA®
- FOUR CIRCLE® HAIDE® HEMY® HERMES® HEAD® LOTUS® RAM® ROYAL® SANCHUN® SWAN® VELO® VISO® WINFIELD® SEZAN®

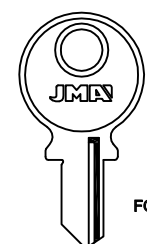

YET-10

YET-10D

- FOR: AKIRA® ASIA® BELL® DEHA®
- FOUR CIRCLE® HAIDE® HEMY® HERMES® HEAD® LOTUS® RAM® ROYAL® SANCHUN® SWAN® VELO® VISO® WINFIELD® SEZAN®

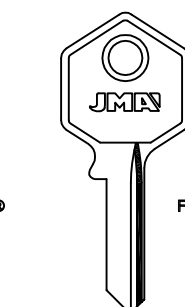

YET-11

YET-11D

- FOR: AKIRA® ASIA® BELL® DEHA®
- FOUR CIRCLE® HAIDE® HEMY® HERMES® HEAD® LOTUS® RAM® ROYAL® SANCHUN® SWAN® VELO® VISO® WINFIELD® SEZAN®

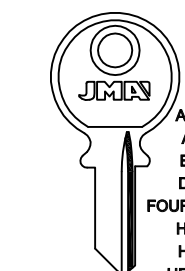

YET-12

YET-12

- FOR: AKIRA® ASIA® BELL® DEHA®
- FOUR CIRCLE® HAIDE® HEMY® HERMES® HEAD® LOTUS® RAM® ROYAL® SANCHUN® SWAN® VELO® VISO® WINFIELD® SEZAN®

FOR: YETI®

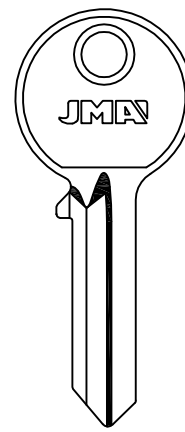

YET-17D

AD500

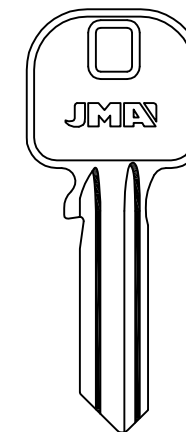

YET-18

AD195

YET-18D

FOR: LOB® -EXPRES® -YARDENI® -YARD®

FOR: LOB®

FOR: YUN HUAN®

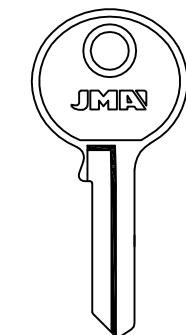

YUH-1D

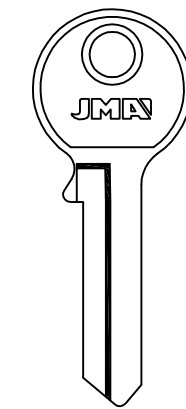

YUH-2D

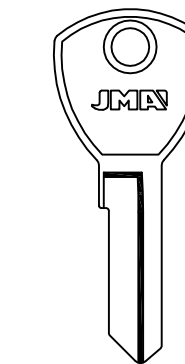









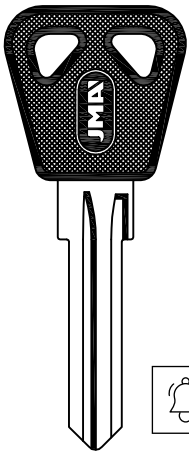
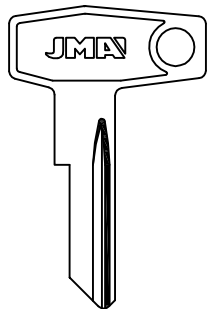
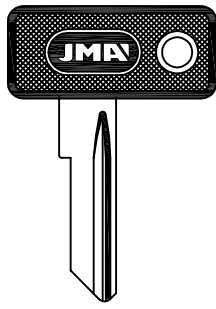
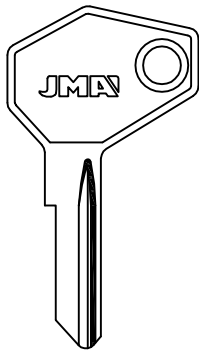
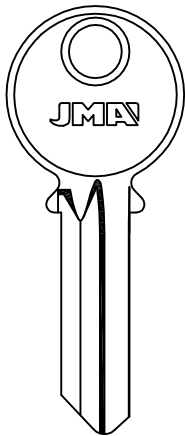

YUH-3D

Concerning the marks and commercial denominations see legal warning.  
 Concerniente a las marcas y denominaciones comerciales ver aviso legal.  
 Marka eta izendapen komertzialiei dagokienez, ikus lege-oharra.  
 Concernant les marques et denominations commerciales voir la note dans l'index.





FOR: YWS®	FOR: ZADI®			FOR: ZENI®
				
				
	....1-1625 ....5001-6278 E...1-710	....1-1625 ....5001-6278 E...1-710	....1-1625 ....5001-6278 E...1-710	
				
FOR: ABUS®	FOR: BRETER®	FOR: BRETER®	FOR: BRETER®	



## DIMPLE KEYS

Llaves de puntos  
Puntuen giltzak

Clés à points  
Bohrmuldenschlüssel

Chaves de pontos  
Klucze nawiercane

Concerning the marks and commercial denominations see legal warning.  
Concerniente a las marcas y denominaciones comerciales ver aviso legal.  
Marka eta izendapen komertzialiei dagokienez, ikus lege-oharra.  
Concernant les marques et dénominations commerciales voir la note dans l'index.



**FOR: ABC®**

ALP. ALP.

FOR: BAGEM®

**FOR: ABUS®**

LAT. LAT. LAT. LAT. LAT. LAT.

EC 75

EXTRA CLASSE

FOR: CISA® -BRICARD®

**FOR: AGB®**

LAT. LAT. LAT. LAT. LAT. LAT.

FOR: SCUDO®

SCUDO 5000

SCUDO 5000

SCUDO 5000

SCUDO 5000

SCUDO 5000

**FOR: AHRAM®**

LAT. LAT.

**FOR: ABUS®**

LAT. LAT. LAT.

EC550

D20

EC-S

**FOR: AGA®**

LAT. LAT.

FOR: COLOMENCA® -FB®

FOR: SERRALLER® -TERCA®

FOR: COLLBAIX®

**FOR: AMIG®**

LAT. LAT. LAT. LAT. LAT. LAT. LAT.

5000

2500

18080

10000E / 10580

MOD.10000

FOR: GMB®

4900

ORIGINAL PLASTIC

**FOR: AGA®**

LAT. LAT. LAT. LAT. LAT. LAT. LAT. LAT. LAT. LAT.

FOR: CASAS®

**FOR: AMIG®**

LAT.

MOD.20000

ORIGINAL PLASTIC

**FOR: APECS®**

LAT. LAT. LAT. LAT. LAT.

FOR: APEX® -APEKS®

FOR: AMIG® -BYP® -C.V.C.®

FOR: FTH® -APEX® -APEKS®

FOR: APEX® -APEKS®

FOR: APEX® -APEKS®

DIAMOND

Concerning the marks and commercial denominations see legal warning.  
 Concerniente a las marcas y denominaciones comerciales ver aviso legal.  
 Marka eta izendapen komertzialiei dagokienez, ikus lege-oharra.  
 Concernant les marques et denominations commerciales voir la note dans l'index.

**JMA®** Opening the future

**JMA®** Opening the future

Beziehen auf die Marke und Handelsname sehen Sie die Notiz im Impressum.  
 Relativamente às marcas e denominações comerciais, ver aviso legal.  
 Jeśli chodzi o znaki i nazwy handlowe, patrz Informacje prawne.



**FOR: ASHICO®**

ASH-2

LAT.

**FOR: AXA®**

DEFENDER

AX-7.P

AX-2.P

VICTORY

AX-5D.P1

DEFENDER

AX-2.P1

AX-6

FOR: BUFFO®

**FOR: AZBE®**

AZ-8D

FOR: IFAM®

**FOR: BEY®**

BEY-1D

LAT.

BEY-2D

LAT.

FOR: WALE®

**FOR: BÖRKEY®**

BKY-1

LAT.

BKY-2

LAT.

FOR: PHILLIPS® -YALTRES®

FOR: PHILLIPS® -YALTRES®

**FOR: BRICARD®**

BRI-16

LAT.

**FOR: AZBE®**

HSE - A14

AZ-40

HSE - A13

AZ-39

ALP.  
\* LAT.

HS7

AZ-29

HS2

2... 3...

AZ-12

HS4 - HS7

J... I...

AZ-9

AZ-9D

FOR: CAVERS® -CENTURION® -ZAIN®

**FOR: BAGEM®**

BAG-1

ALP.

**FOR: BRICARD®**

BRI-25

LAT.

BRI-26

BRI-27

BRI-28

BRI-29

BRI-30

BRI-31

BRI-33

BRI-34

LAT.

FOR: STANDERS®

**FOR: BRISANT®**

BRN-2D

BRN-1D

LAT.

FOR: ULTION® -FEDERAL® -HUGO®

**FOR: BAODEAN®**

BDA-1

LAT.

FOR: BTV®

**FOR: BASI®**

BAI-8D

LAT.

FOR: GEVY® -SATURN® -AMIG®

FOR: LEGALLAIS®

BAI-9D

LAT.

FOR: TOVER®

BAI-13D

LAT.

CX

BAT-1D

LAT.

UNITE-5600

**FOR: BULAT®**

BUL-1

LAT.

FOR: FTH® - THIRARD®

**FOR: BURG®**

BUR-43

BUR-33

LAT.

FOR: BURG WACHTER®

BUR-41

LAT.

FOR: BURG WACHTER®

**FOR: CAYS®**

CAY-2

LAT.

FOR: ISEO®

**FOR: CES®**

CE-114

LAT.

Concerning the marks and commercial denominations see legal warning.  
 Concerniente a las marcas y denominaciones comerciales ver aviso legal.  
 Marka eta izendapen komertzialiei dagokienez, ikus lege-oharra.  
 Concernant les marques et denominations commerciales voir la note dans l'index.

**JMA®** Opening the future

**JMA®** Opening the future

Beziehen auf die Marke und Handelsname sehen Sie die Notiz im Impressum.  
 Relativamente às marcas e denominações comerciais, ver aviso legal.  
 Jeśli chodzi o znaki i nazwy handlowe, patrz Informacje prawne.



**FOR: CHUBB®**

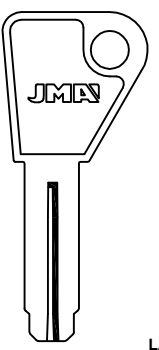

FOR: AVA® -CHUBB®

**FOR: CISA®**

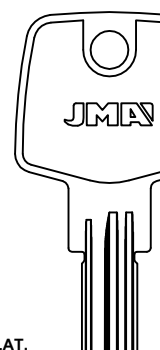

LAT. 7.35  
2.35  
CI-14

A/AZIZA/Z.....  
000001-030198

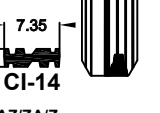

CI-17

**FOR: ABUS® -ASTRAL® -BRICARD®**

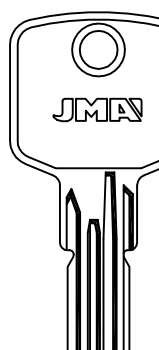

LAT. 8.2  
2.85  
CI-21



CI-25



CI-26



CI-30



CI-31



CI-32



CI-33



CI-35



CI-56



CI-59



CI-60



CI-67



CI-81



CI-73



CI-72



CI-71



8.2  
2.85  
CI-48

**FOR: ABUS® -GERDA®**

**FOR: DEKABA®**

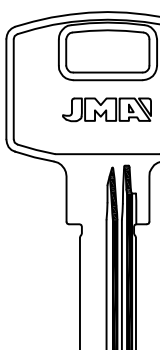

LAT. 7.2  
2.5  
DEK-4

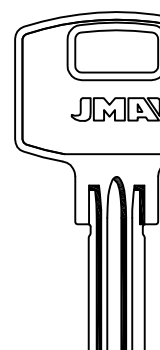

FOR: MAUER®



LAT. C42  
8.6  
2.5  
DEK-16

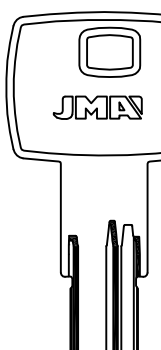

LAT. 8.65  
2.3  
DEK-17

**FOR: DELCA®**

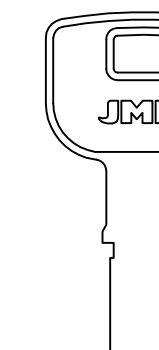

LAT. 9  
2.4  
DLC-2



FOR: GEVY®

**FOR: CISA®**

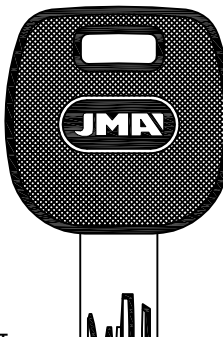

LAT. CI-77.P



CI-76.P



CI-75.P



CI-73.P

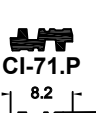

CI-72.P



CI-71.P



8.2  
2.85  
CI-48.P

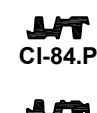

CI-84.P

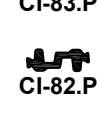

CI-83.P

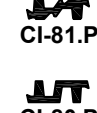

CI-82.P



CI-81.P



CI-80.P



CI-79.P



CI-78.P

**FOR: ABUS®**

**FOR: CORBIN®**

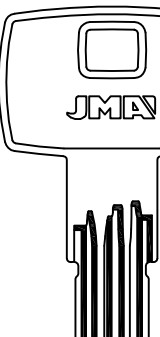

LAT. 9.4  
2.9  
COR-37

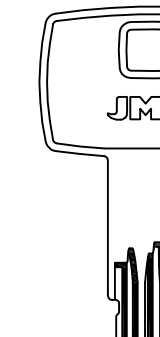

LAT. 9.4  
2.9  
COR-77

**FOR: IFAM®**

**FOR: DELCA®**

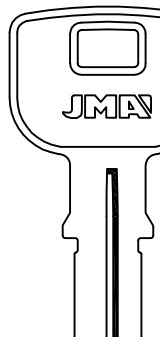

LAT. 9  
2.45  
DLC-3

**FOR: DELTA®**

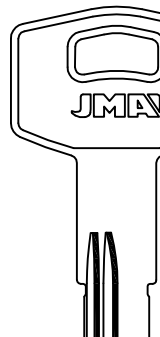

LAT. 8.6  
2.3  
DLT-1D

**FOR: DIERRE®**

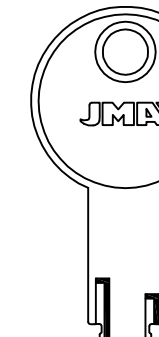

LAT. 6.8  
2.57  
DR-1

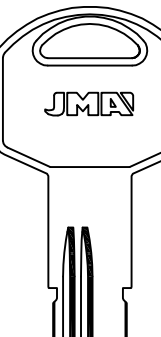

LAT. 9.7  
AS6  
2.8  
DR-2D

**FOR: ATRA®**

**FOR: DOM®**

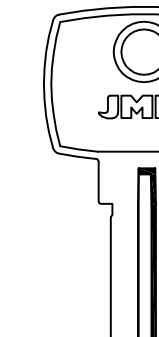

LAT. 8.82  
2.2  
DOM-17I

**FOR: CORBIN® -EMHART®**

**FOR: CVL®**

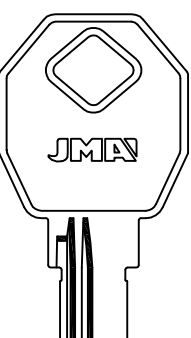

LAT. 8.7  
8.9  
2.4  
CVL-9D

**FOR: DAF®**

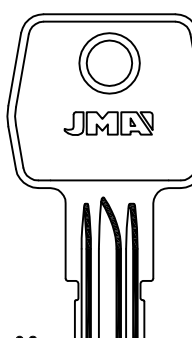

LAT. 9.2  
2.8  
DAF-2



FOR: CARDO®



FOR: CARDO®

**FOR: DASS®**

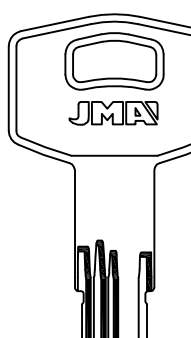

LAT. 8.7  
H2.3  
2.3  
DAS-1D

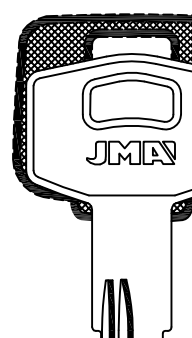

LAT. 8.6  
2.3  
DLT-1D

**FOR: DEKABA®**

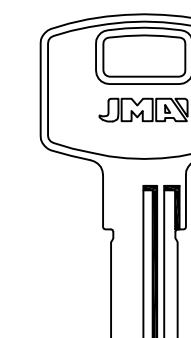

LAT. 8.4  
2.45  
DEK-3

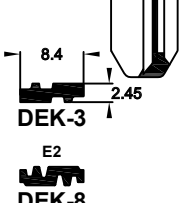

E2  
DEK-8

**FOR: MAUER® -M&D® -ROTO®**

**FOR: DOM®**

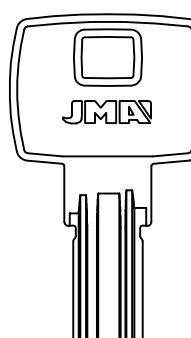

ALP. 8.9  
2.1  
DOM-22

**FOR: ARCU®**

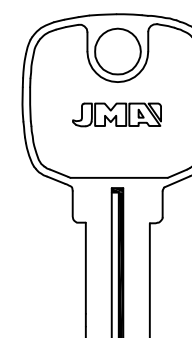

ALP. 8.4  
2.4  
DOM-30

**FOR: MOREAUX®**

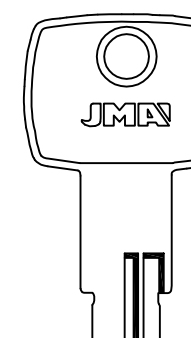

LAT. 8.9  
IX 5  
2.35  
DOM-31

**FOR: CORBIN® -EMHART®**

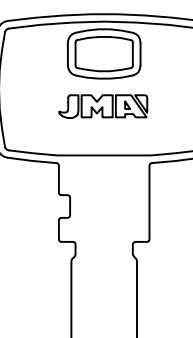

ALP. 8.5  
2.3  
DOM-32

**FOR: CORBIN® -EMHART®**

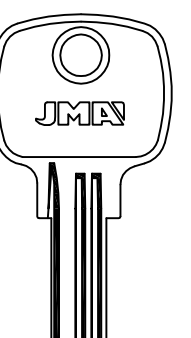

LAT. 7.1  
2Y  
2  
DOM-33

Concerning the marks and commercial denominations see legal warning.  
 Concerniente a las marcas y denominaciones comerciales ver aviso legal.  
 Marka eta izendapen komertzialiei dagokienez, ikus lege-oharra.  
 Concernant les marques et dénominations commerciales voir la note dans l'index.

**JMA®** Opening the future

**JMA®** Opening the future

Beziehen auf die Marke und Handelsname sehen Sie die Notiz im Impressum.  
 Relativamente às marcas e denominações comerciais, ver aviso legal.  
 Jeśli chodzi o znaki i nazwy handlowe, patrz Informacje prawne.





**FOR: DOM®**

ALP. LAT. LAT. ALP. ALP.

DOM-34: 7.35, 2.05  
DOM-39: 7.1, 2.3  
DOM-43: 7.1, 2.3  
DOM-56D: 9.4, 2.3  
DOM-63D: 9.4, 2.3  
DOM-B1: 9, 2.5  
DOM-B2: 9, 2.5  
DOM-B6: 9, 4.1

FOR: CORBIN®-STS®

**FOR: DOMUS®** **FOR: ELZETT®** **FOR: EUROLOCKS®** **FOR: EZCURRA®**

LAT. LAT. LAT. LAT. ALP. LAT. ALP. LAT. LAT.

DO-3: 7, 2.2  
DO-4: 7, 2.2  
ELZ-10: 8.9, 2.8  
ELZ-10D: 8.9, 2.8  
ELZ-13: 9.4, 2.85  
EU-12: 7.6, 2.9  
EZ-DS10: 7.45, 2.3  
EZ-DS10E: 7.45, 2.3  
TD-25: 8.5, 2.35

FOR: HOBBY®-HYMER®

**FOR: EZCURRA®** **FOR: FAC®**

LAT. WColor (LAT.) ALP. LAT. LAT.

EZ-DS15: 7.45, 2.3  
EZ-DS15R: 7.45, 2.3  
FAC-19: 8.6, 2.3  
FAC-23: 8.9, 2.35  
FAC-24: 8.9, 2.35

**FOR: FAC®** **FOR: FAVOUR®** **FOR: FAYN®** **FOR: FCV®** **FOR: FERONERIA®**

LAT. LAT. LAT. LAT. LAT.

FAC-25: 8.6, 2.3  
FAV-1D: 8.8, 2.35  
FAV-2: 8.8, 2.35  
FAY-1D: 8.35, 2.25  
FV-3: 8.9, 2.75  
FER-2D: 8.6, 2.4

FOR: TEICOCIL®

FOR: KFV®-VBH®

FOR: VF (VEROFER)®

**FOR: F.F.®** **FOR: FTH®**

LAT. ALP. ALP. LAT. LAT.

FF-13: 9.4, 2.7  
TD-7: 8.6, 2.85  
TD-16: 8.85, 2.95  
TD-23: 7.9, 2.95  
TD-30: 8.6, 2.35

FOR: FACCHINETTI®

FOR: CODEM®-TOVER®-YALTRES®-VACHETTE®

FOR: IFAM®-KARO®-THIRARD®

FOR: ATLANTIC®

FOR: THIRARD®

**FOR: FTH®** **FOR: GERDA®** **FOR: GEVY®**

LAT. LAT. LAT. LAT. LAT.

TD-26D: 8.7, 2.35  
TD-29: 8.65, 2.8  
GDA-1.P: 8.66, 2.8  
GDA-4D: 8.7, 2.45  
GEV-3D: 8.9, 2.8

FOR: SP®-THIRARD®

FOR: THIRARD®

FOR: MOTTURA®

Concerning the marks and commercial denominations see legal warning.  
 Concerniente a las marcas y denominaciones comerciales ver aviso legal.  
 Marka eta izendapen komertzialiei dagokienez, ikus lege-oharra.  
 Concernant les marques et dénominations commerciales voir la note dans l'index.

**JMA®** Opening the future

**JMA®** Opening the future

Beziehen auf die Marke und Handelsname sehen Sie die Notiz im Impressum.  
 Relativamente às marcas e denominações comerciais, ver aviso legal.  
 Jeśli chodzi o znaki i nazwy handlowe, patrz Informacje prawne.

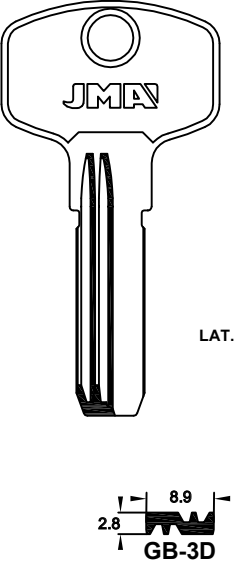
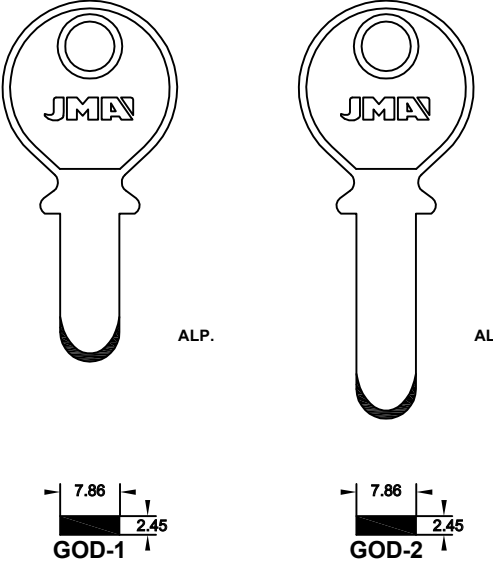
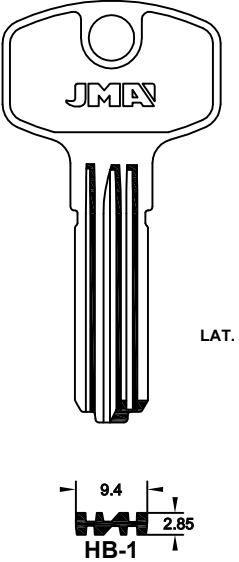
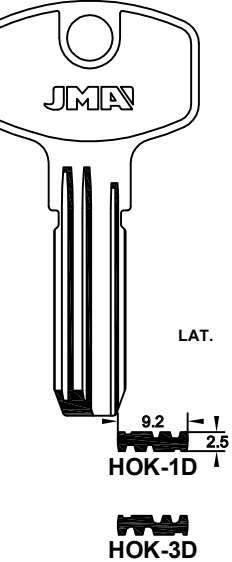

<p>FOR: GMB®</p>  <p>LAT.</p> <p>GB-3D</p>	<p>FOR: GODREJ®</p>  <p>ALP.</p> <p>GOD-1</p> <p>GOD-2</p>	<p>FOR: HB®</p>  <p>LAT.</p> <p>HB-1</p>	<p>FOR: HOK®</p>  <p>LAT.</p> <p>HOK-1D</p> <p>HOK-3D</p>
		FOR: LEGALLAIS®	FOR: MEGA®

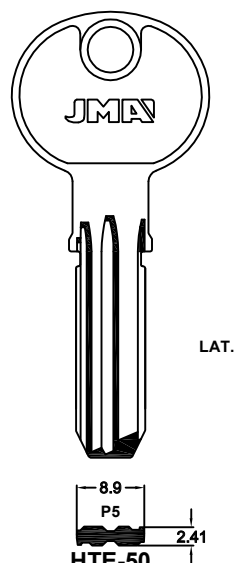
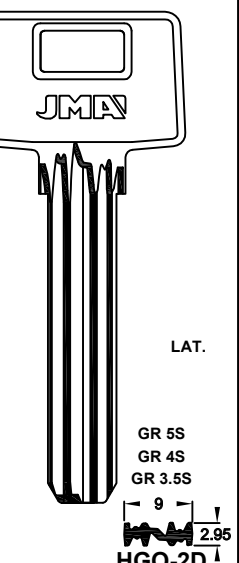
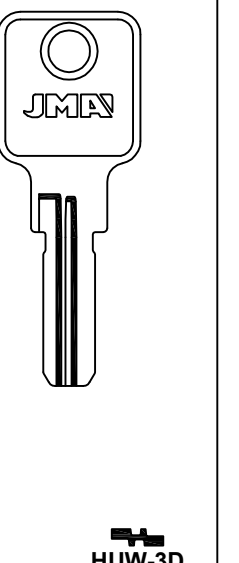
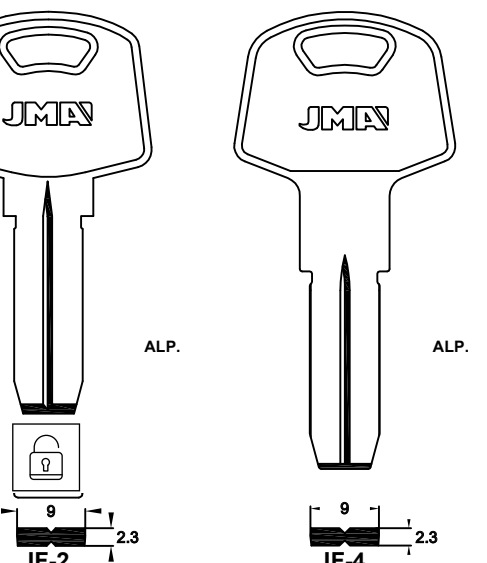
<p>FOR: HTEC®</p>  <p>LAT.</p> <p>HTE-50</p>	<p>FOR: HUGO®</p>  <p>LAT.</p> <p>HGO-2D</p>	<p>FOR: HUWIL®</p>  <p>LAT.</p> <p>HUW-3D</p>	<p>FOR: IFAM®</p>  <p>ALP.</p> <p>IF-2</p> <p>IF-4</p>	
FOR: THT® -TESA®			FOR: CEKA® - HeFELE® FOR: MAUSER® -SCHERF®	

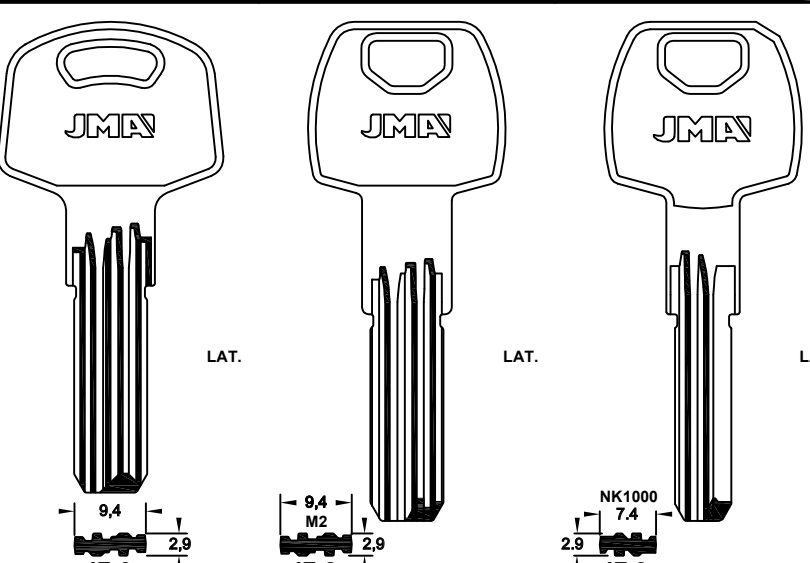
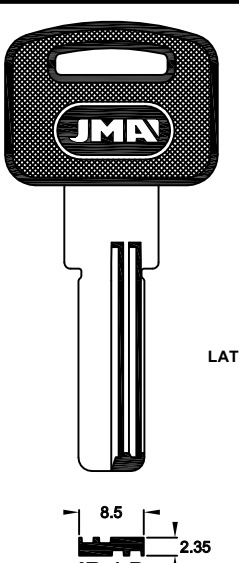
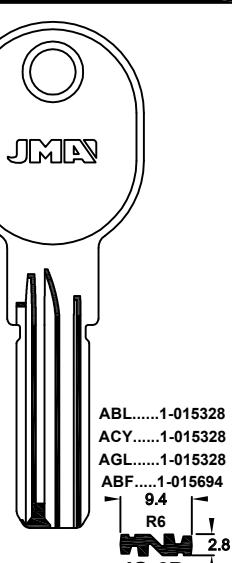
<p>FOR: IFAM®</p>  <p>LAT.</p> <p>IF-6</p> <p>IF-8</p> <p>IF-9</p>	<p>FOR: IR®</p>  <p>LAT.</p> <p>IR-1.P</p>	<p>FOR: ISEO®</p>  <p>LAT.</p> <p>IS-6D</p>
	FOR: BYP® -IFAM®	FOR: MD® -VACHETTE®

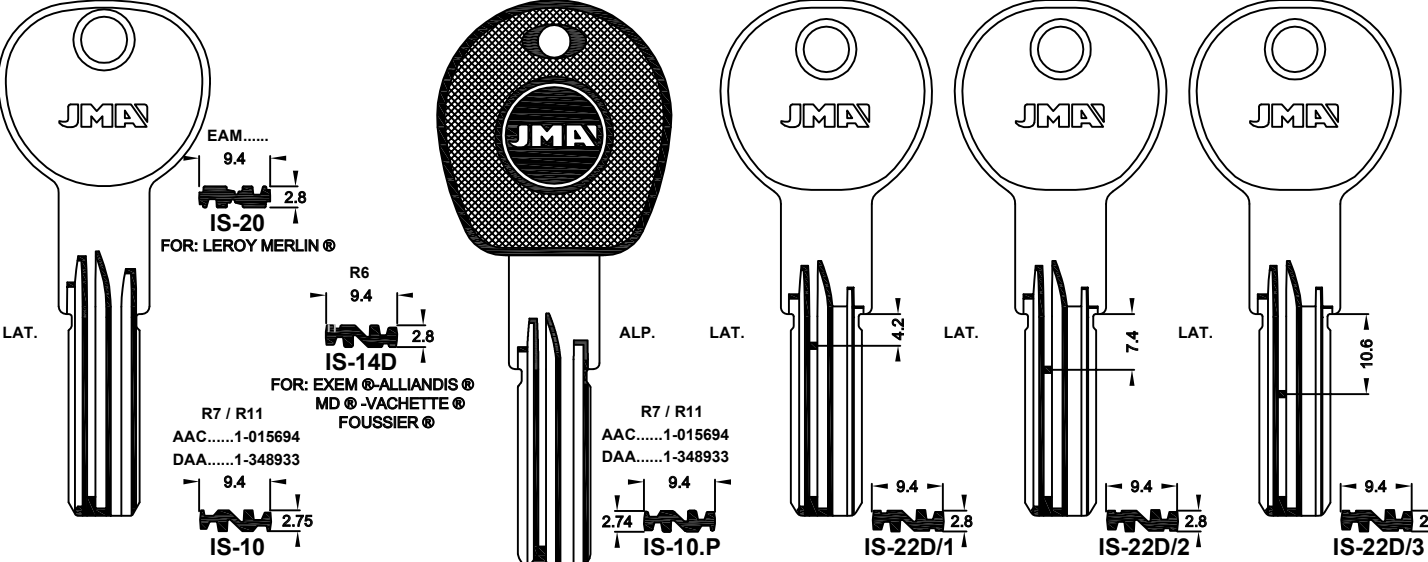
<p>FOR: ISEO®</p>  <p>LAT.</p> <p>IS-20</p> <p>IS-14D</p> <p>IS-10</p> <p>IS-10.P</p> <p>IS-22D/1</p> <p>IS-22D/2</p> <p>IS-22D/3</p>				
FOR: LEROY MERLIN®		FOR: EXEM® -ALLIANDIS® MD® -VACHETTE® FOUSSIER®		FOR: ATRA®
FOR: ATRA® -GERDA®		FOR: GERA®		

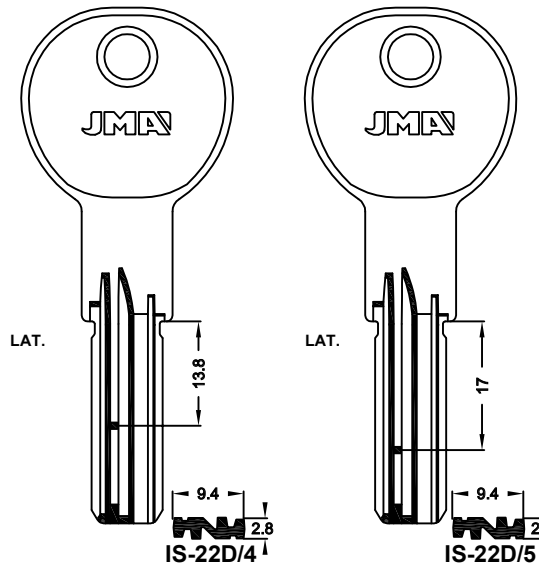
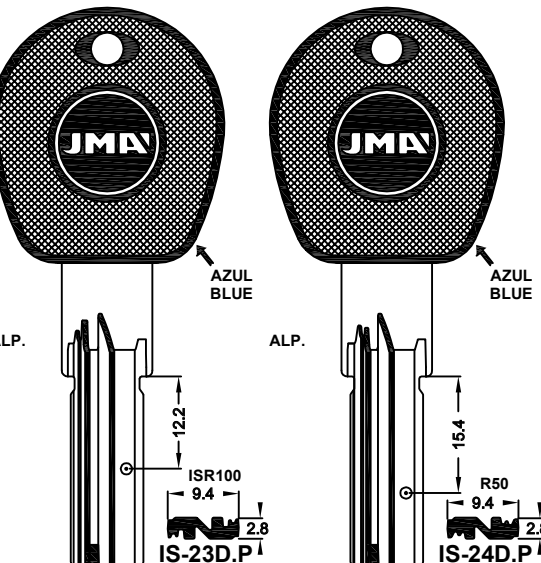
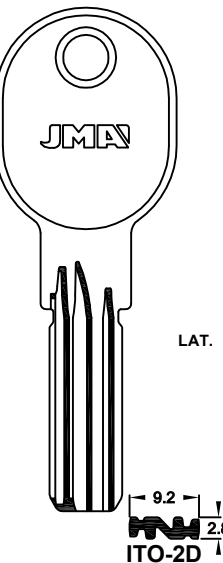
<p>FOR: ISEO®</p>  <p>LAT.</p> <p>IS-22D/4</p> <p>IS-22D/5</p>		<p>FOR: ISEO®</p>  <p>ALP.</p> <p>IS-23D.P</p> <p>IS-24D.P</p>		<p>FOR: ITO®</p>  <p>LAT.</p> <p>ITO-2D</p>
		FOR: DIERRE® - ATRA®		

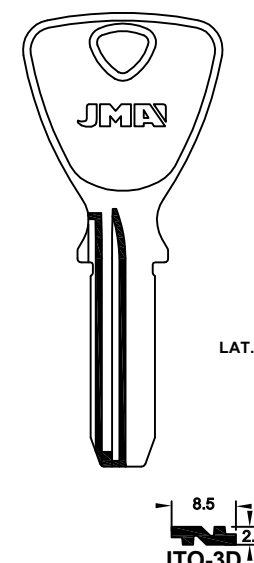
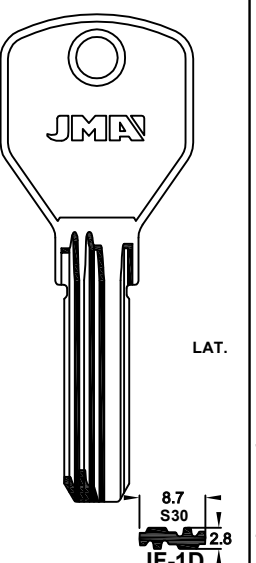
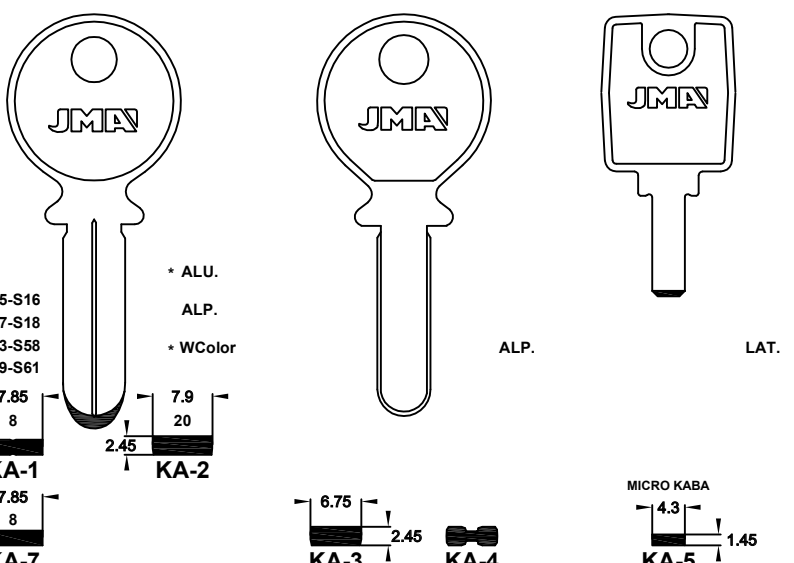
<p>FOR: ITO®</p>  <p>LAT.</p> <p>ITO-3D</p>	<p>FOR: JNF®</p>  <p>LAT.</p> <p>JF-1D</p>	<p>FOR: KABA®</p>  <p>LAT.</p> <p>KA-1</p> <p>KA-2</p> <p>KA-3</p> <p>KA-4</p> <p>KA-5</p>		
		FOR: LÁSBOLAGET®		
		FOR: GEMINI®		

Concerning the marks and commercial denominations see legal warning.  
 Concerniente a las marcas y denominaciones comerciales ver aviso legal.  
 Marka eta izendapen komertzialiei dagokienez, ikus lege-oharra.  
 Concernant les marques et dénominations commerciales voir la note dans l'index.

**JMA** Opening the future

**JMA** Opening the future

Beziehen auf die Marke und Handelsname sehen Sie die Notiz im Impressum.  
 Relativamente às marcas e denominações comerciais, ver aviso legal.  
 Jeśli chodzi o znaki i nazwy handlowe, patrz Informacje prawne.



FOR: KABA®

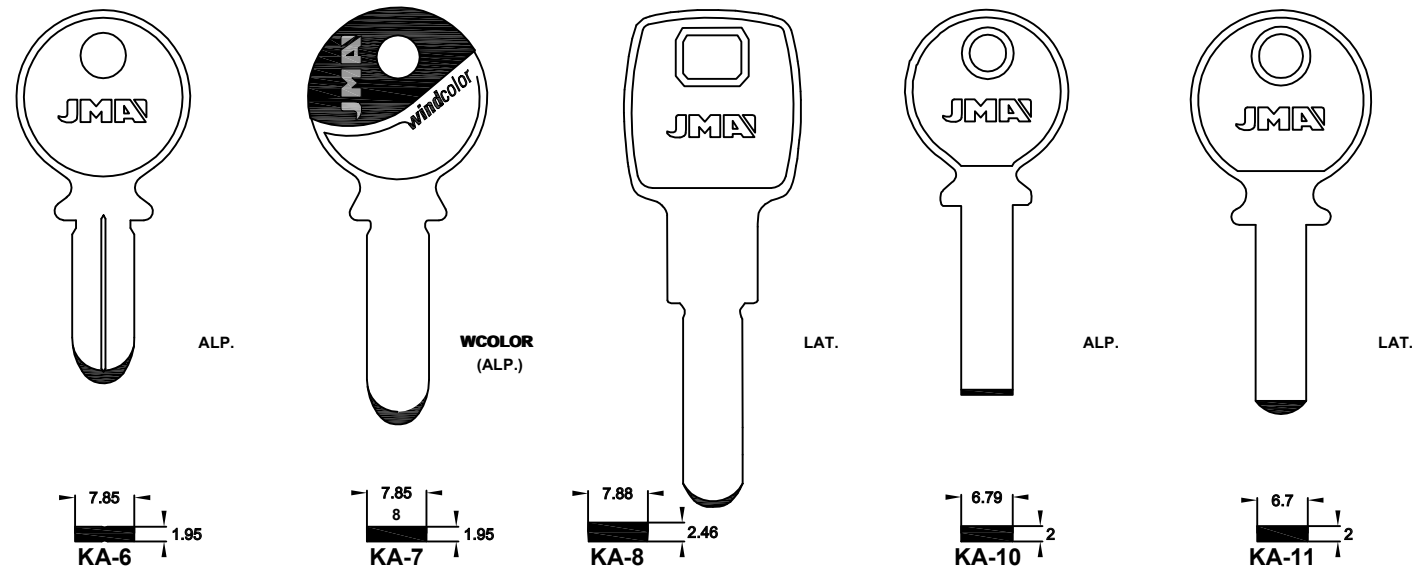

FOR: LASBOLAGET®

FOR: KALE®

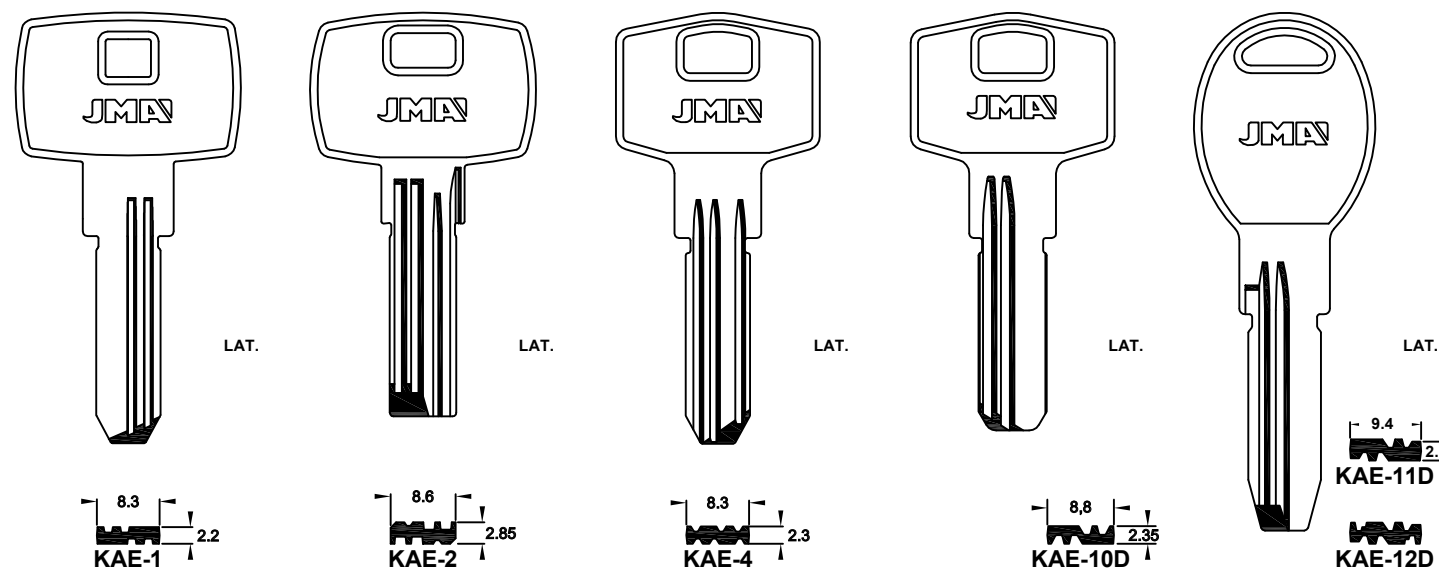

FOR: JIS®

FOR: FAC®-ROTO®

FOR: KALE®

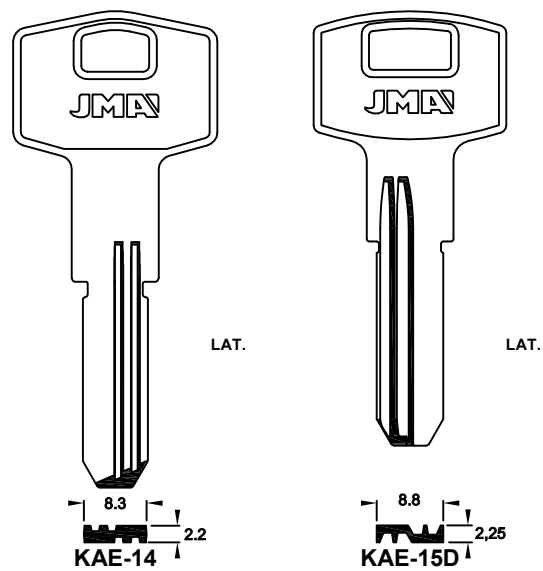

FOR: KESO®

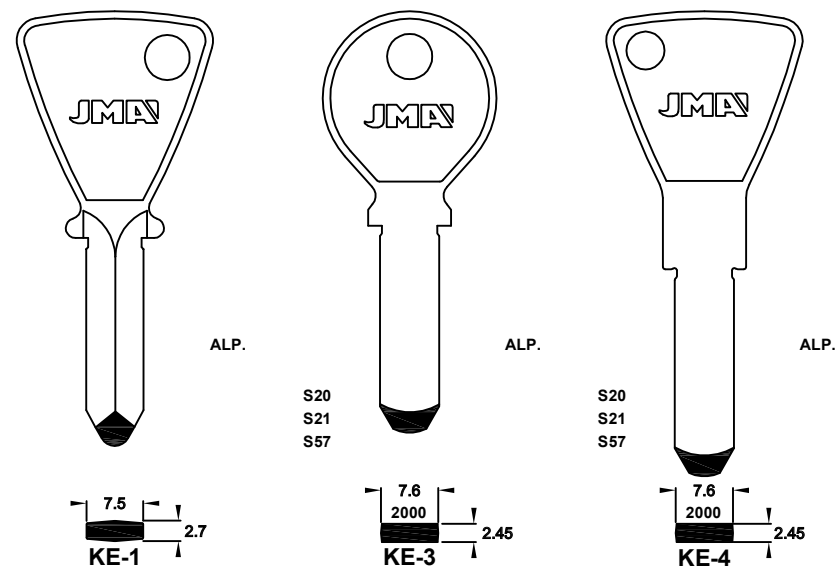

FOR: JPM®

FOR: KESO®

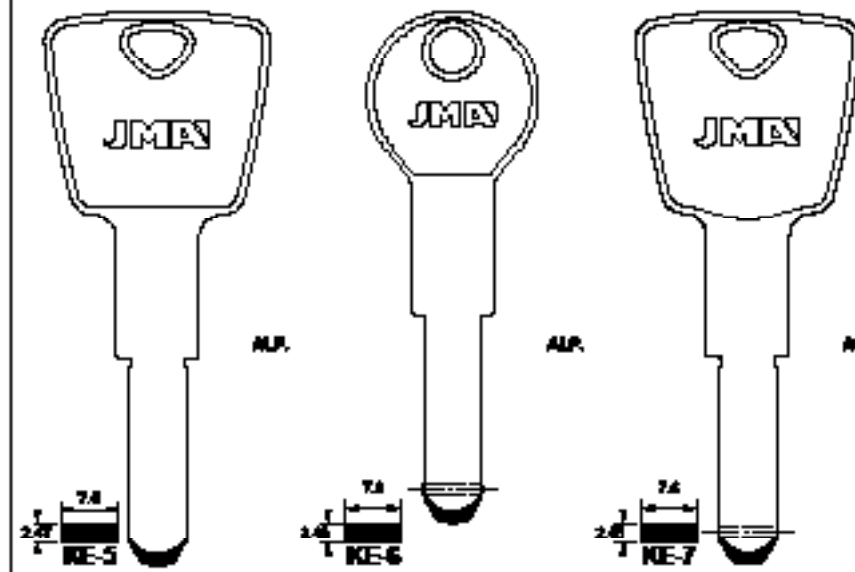

FOR: LAPERCHE®

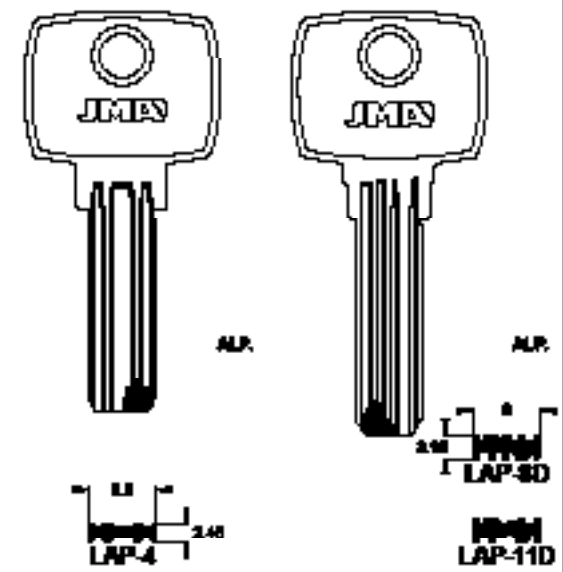

FOR: LAPERCHE®

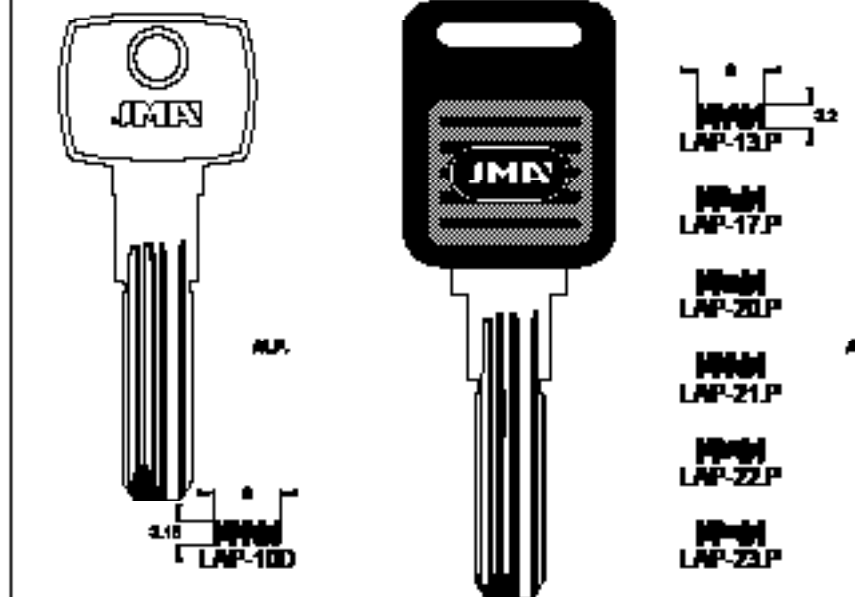

FOR: LINCE®

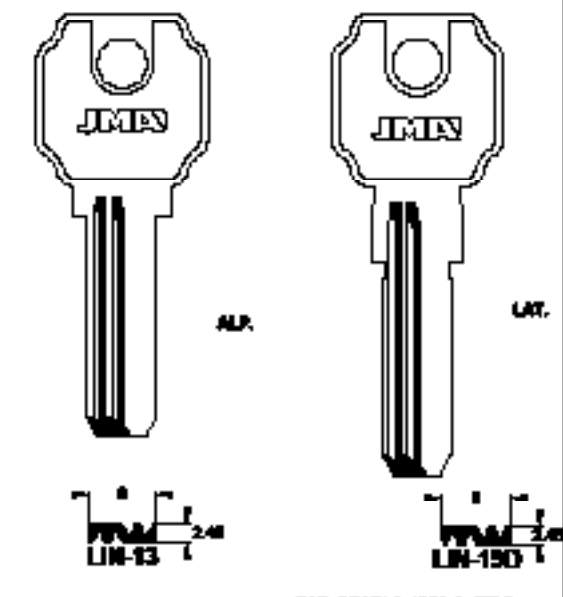

FOR: GRAN®-JMA®-SIB®

FOR: LINCE®

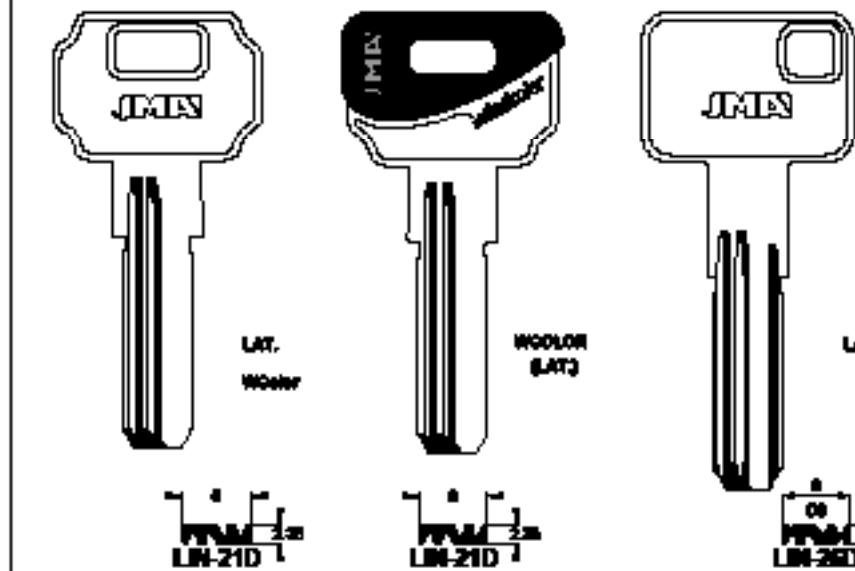

FOR: LT®

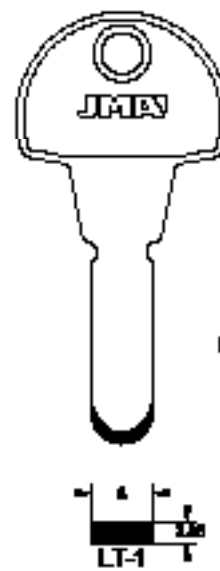

FOR: MAGNUM®

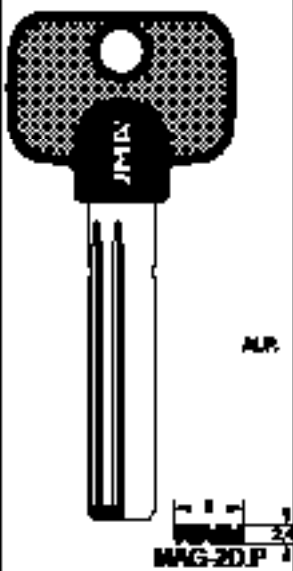

Concerning the marks and commercial denominations see legal warning.  
 Concerniente a las marcas y denominaciones comerciales ver aviso legal.  
 Marka eta izendapen komertzialiei dagokienez, ikus lege-oharra.  
 Concernant les marques et dénominations commerciales voir la note dans l'index.

**JMA** Opening the future

**JMA** Opening the future

Beziehen auf die Marke und Handelsname sehen Sie die Notiz im Impressum.  
 Relativamente às marcas e denominações comerciais, ver aviso legal.  
 Jeśli chodzi o znaki i nazwy handlowe, patrz Informacje prawne.



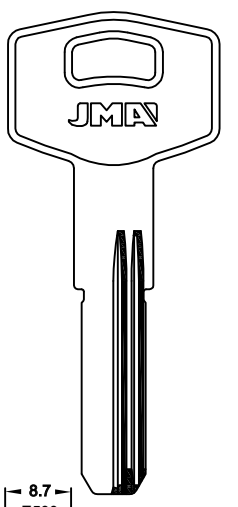
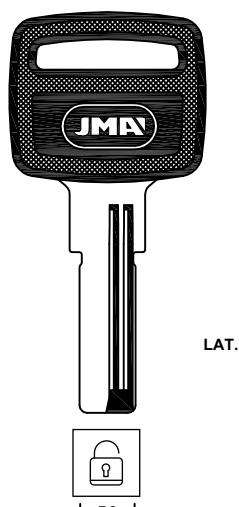
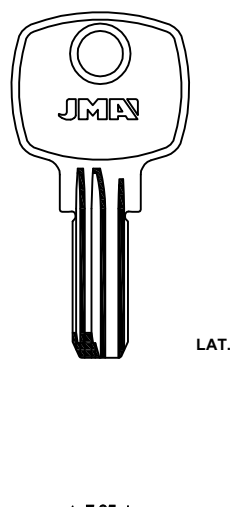
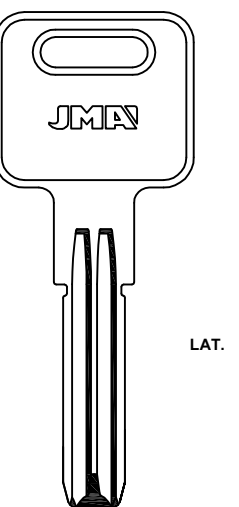

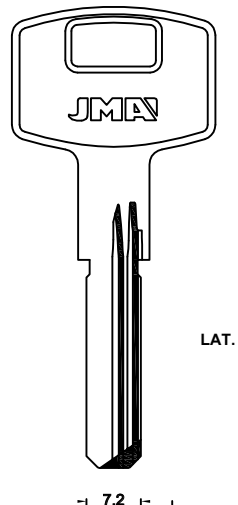
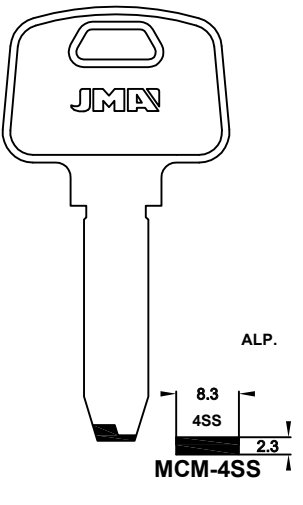
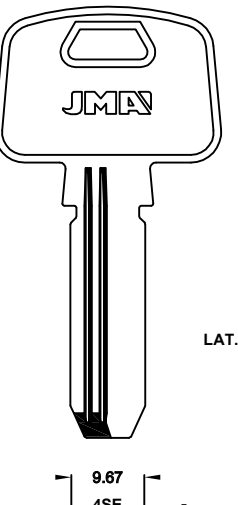
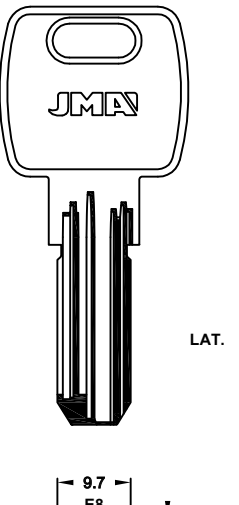
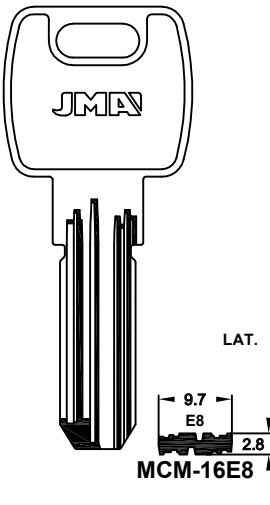

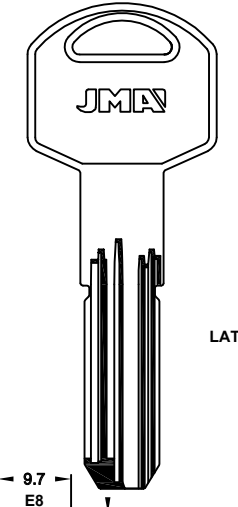
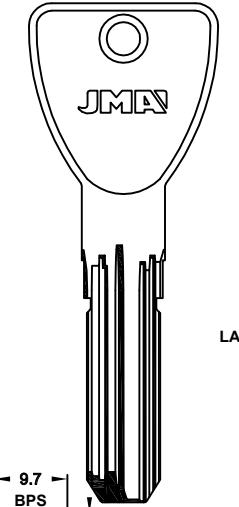
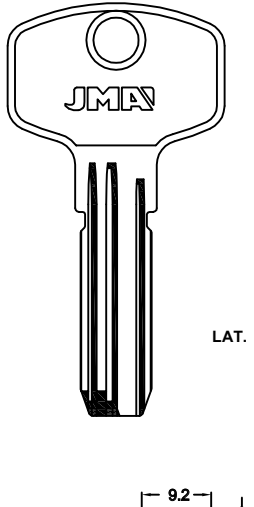
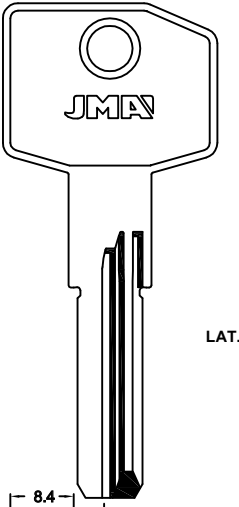
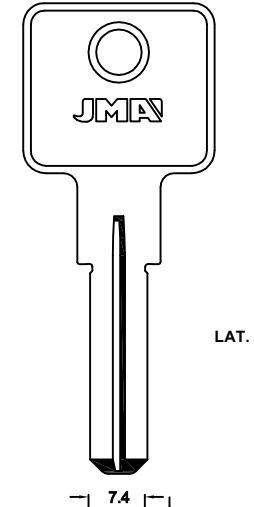
<p><b>FOR: MARQUES®</b></p>  <p>MQ-3</p> <p>790 E500 796</p> <p>FOR: AGC®-MARC®-RODES®</p>	<p><b>FOR: MASTER®</b></p>  <p>MAS-15.P</p>	<p><b>FOR: MASTER LOCK®</b></p>  <p>MASL-1</p>	<p><b>FOR: MAUER®</b></p>  <p>MAU-1</p>
---	---	--	--

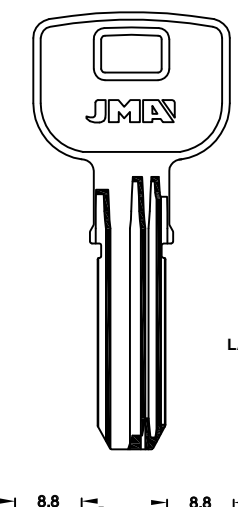
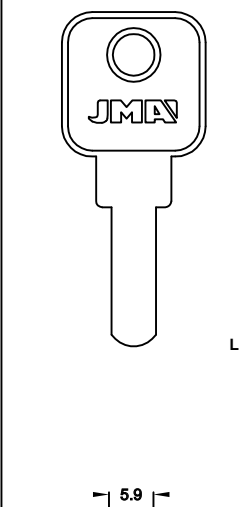
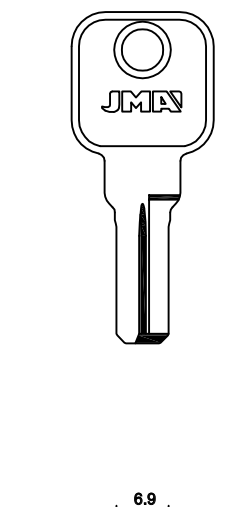
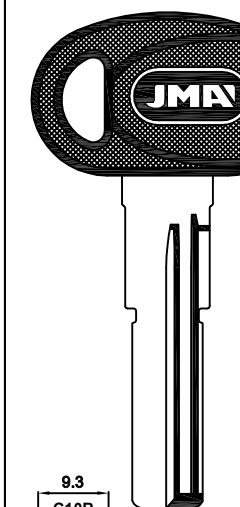
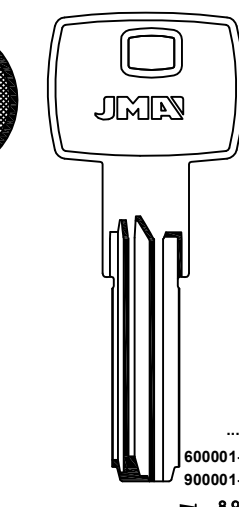
<p><b>FOR: MAUER®</b></p>  <p>MAU-2</p>	<p><b>FOR: MCM®</b></p>  <p>MCM-4SS</p> <p>FOR: LOB®-YETI®</p>  <p>MCM-10</p> <p>FOR: ESAFE®-TROMER®</p>  <p>MCM-15E8</p>  <p>MCM-21D</p> <p>FOR: DIERRE®-GERDA®</p>			
--	---	--	--	--

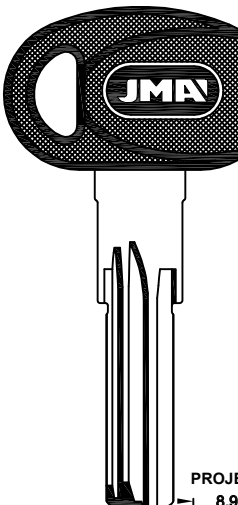
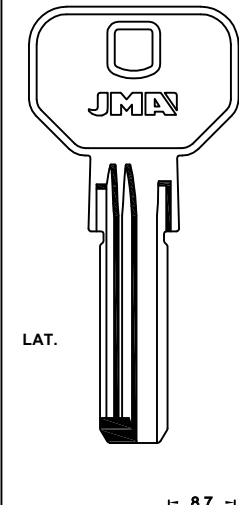
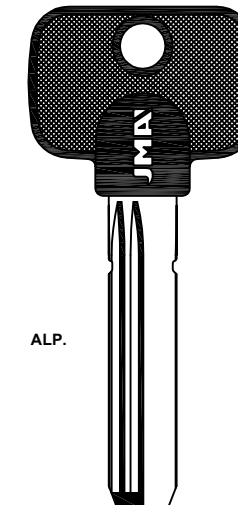
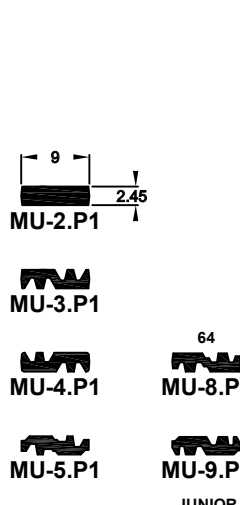
<p><b>FOR: MCM®</b></p>  <p>MCM-27</p> <p>FOR: GERDA®</p>	<p><b>FOR: MCM®</b></p>  <p>MCM-45</p>	<p><b>FOR: MEGA®</b></p>  <p>MEG-1D</p> <p>FOR: HOK®</p>	<p><b>FOR: MG (MONTI)®</b></p>  <p>MGA-2</p> <p>FOR: TROMER®</p>	<p><b>FOR: MG (MONTI)®</b></p>  <p>MGA-3</p>
---	---	---	--	---

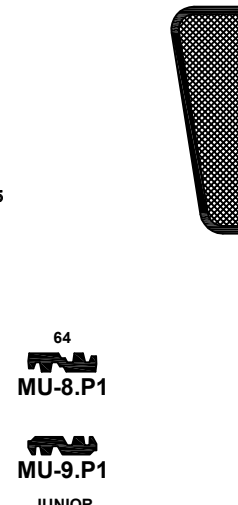
<p><b>FOR: MHA®</b></p>  <p>MH-1</p> <p>FOR: TOP LOCK®</p>	<p><b>FOR: MLM®</b></p>  <p>MLM-4</p>	<p><b>FOR: MLM®</b></p>  <p>MLM-8</p> <p>FOR: LEHMANN®</p>	<p><b>FOR: MOTTURA®</b></p>  <p>MT-1.P</p> <p>600001-613040 900001-902780</p>	<p><b>FOR: MOTTURA®</b></p>  <p>MT-2D</p> <p>FOR: GEVY®-STV®</p>
--	---	--	---	--

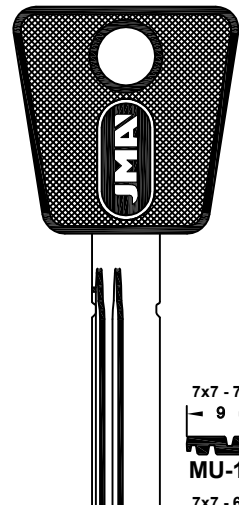
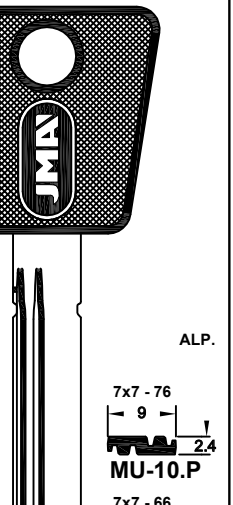
<p><b>FOR: MOTTURA®</b></p>  <p>MU-2.P1</p>	<p><b>FOR: MSM®</b></p>  <p>MSM-1D</p>	<p><b>FOR: MUL.T.LOCK®</b></p>  <p>MU-3.P1</p>  <p>MU-4.P1</p>  <p>MU-5.P1</p>  <p>MU-7.P1</p>  <p>MU-8.P1</p>  <p>MU-9.P1</p>  <p>MU-11.P1</p> <p>FOR: GAMMA®</p>			<p><b>FOR: MUL.T.LOCK®</b></p>  <p>MU-10.P</p>  <p>MU-16.P</p>
---	--	--	--	--	--

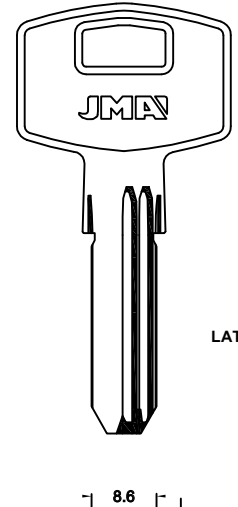
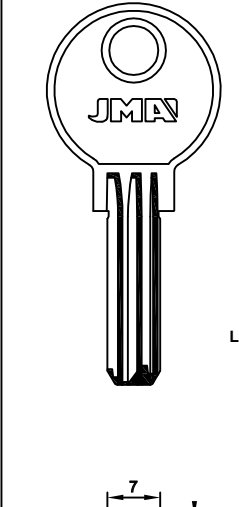
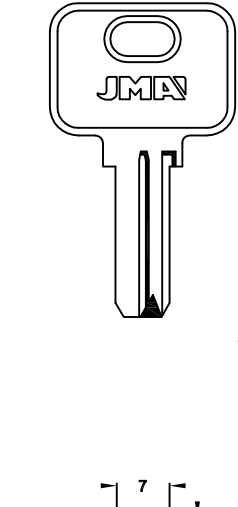
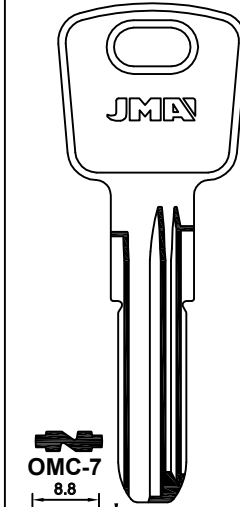
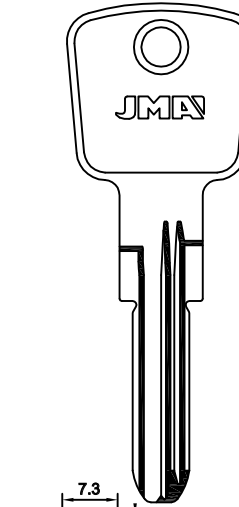
<p><b>FOR: NOORI®</b></p>  <p>NOR-1</p> <p>FOR: IBFM®</p>	<p><b>FOR: OJMAR®</b></p>  <p>OJ-20/4</p>	<p><b>FOR: OJMAR®</b></p>  <p>OJ-Q</p>	<p><b>FOR: OMEC®</b></p>  <p>OMC-7</p> <p>FOR: SANTOS®-CAIB®-IPAR®</p>	<p><b>FOR: OMEC®</b></p>  <p>OMC-4</p> <p>FOR: IMPAR®</p>
--	--	---	---	--

Concerning the marks and commercial denominations see legal warning.  
 Concerniente a las marcas y denominaciones comerciales ver aviso legal.  
 Marka eta izendapen komertzialiei dagokienez, ikus lege-oharra.  
 Concernant les marques et dénominations commerciales voir la note dans l'index.

**JMA®** Opening the future

**JMA®** Opening the future

Beziehen auf die marke und handelsname sehen sie die notiz im Impressum.  
 Relativamente às marcas e denominações comerciais, ver aviso legal.  
 Jeśli chodzi o znaki i nazwy handlowe, patrz Informacje prawne.





FOR: PICARD®  LAT. PIC-10	FOR: POTENT®  LAT. PTN-10 PTN-20 PTN-30 PTN-40			FOR: PREFER®  LAT. PR-21 PR-22
------------------------------------	--	--	--	--

FOR: STS®  ALP. STS-01 STS-14 STS-15 STS-16 STS-17 STS-18 STS-19 STS-20 STS-21 STS-22 STS-23 STS-24 STS-25				
---	--	--	--	--

FOR: ROSSETTI®  LAT. ROSE-1	FOR: SEA®  ALP. SEA-1 SEA-2		FOR: SECUREMME®  LAT. SEC-1 SEC-2 SEC-3 SEC-4LP	
--------------------------------------	---	--	---	--

FOR: STS®  LAT. STS-26	FOR: TARONI®  LAT. TRD-1 TRD-10	FOR: TECON®  LAT. TC-1 TC-3	FOR: TECSESA®  ALP. TEC-2
---------------------------------	---	---	------------------------------------

FOR: SECURITAL®  SAL. SCR-1	FOR: SERRALLER®  LAT. SER-30	FOR: SPIDER®  LAT. SPI-1 SPI-10	FOR: STANDERS®  LAT. STN-10	FOR: STS®  ALP. STS-35 STS-38
--------------------------------------	---------------------------------------	---	--------------------------------------	---

FOR: TESA®  ALP. WOLOR (LAT) LAT. TESA-10 TESA-11 TESA-12 TESA-13 TESA-14				
--	--	--	--	--

Concerning the marks and commercial denominations see legal warning.  
 Concerniente a las marcas y denominaciones comerciales ver aviso legal.  
 Marka eta izendapen komertzialiei dagokienez, ikus lege-oharra.  
 Concernant les marques et dénominations commerciales voir la note dans l'index.



Beziehen auf die marke und handelsname sehen sie die notiz im Impressum.  
 Relativamente às marcas e denominações comerciais, ver aviso legal.  
 Jeśli chodzi o znaki i nazwy handlowe, patrz Informacje prawne.

**FOR: TESA®**

ALP. ALP.

TE-T80  
TE-T80EH  
TE-T80SC  
TE-T82

FOR: ESAFE® - STS® - TOPLOCK® - YEMAR®

**FOR: TITAN®**

LAT. LAT. LAT. LAT.

TIT-6  
TIT-21  
TIT-22  
TIT-23  
TIT-27

FOR: CR® - DECAEUX® - IMPAR®  
FOR: UCER®  
FOR: HERACLES®

**FOR: UCER®**

ALP. ALP. LAT. LAT. ALP.

UCER-8D.P  
UCER-13D  
UCER-17D  
UCER-20D  
UCER-21

FOR: PH®  
FOR: REMOCON®

**FOR: TITAN®**

LAT.

TIT-26

FOR: BASI® - METALUX®

**FOR: T-KEY®**

LAT.

TKY-2  
TKY-3

FOR: BAILING LOCK® - LOB®

**FOR: TOVER®**

ALP. ALP. ALP. \* LAT.

TOV-2  
TOV-4  
TOV-5  
TOV-8D

FOR: TROMER®

**FOR: UCER®**

LAT.

UCER-22D

**UNIVERSAL**

LAT. LAT. LAT. LAT.

TX-1  
TX-2  
TX-17  
TX-22

FOR: ISEO® - GERDA®

**FOR: URBIS®**

LAT.

URB-3D  
URB-4D

FOR: BANE SEKULIC®

**FOR: TOVER®**

LAT. LAT.

TOV-6  
TOV-7

**FOR: UCER®**

ALP. LAT. WColor (LAT.)

UCER-51  
UCER-5D  
UCER-8D  
UCER-8D'

FOR: PENT®  
FOR: DEBEAURAIN®  
FOR: ESAFE®  
FOR: ISEO®  
FOR: ND®  
FOR: YEMAR®

**FOR: VACHETTE®**

ALP. ALP. ALP. LAT. ALP.

VA-25  
VA-26  
VA-27  
VA-28  
VA-56  
VA-58  
VA-70  
VA-91

FOR: RADIAL®  
FOR: RADIAL®  
FOR: RADIAL®  
NEW VER. 1998

Concerning the marks and commercial denominations see legal warning.  
 Concerniente a las marcas y denominaciones comerciales ver aviso legal.  
 Marka eta izendapen komertzialiei dagokienez, ikus lege-oharra.  
 Concernant les marques et denominations commerciales voir la note dans l'index.



Beziehen auf die marke und handelsname sehen sie die notiz im Impressum.  
 Relativamente às marcas e denominações comerciais, ver aviso legal.  
 Jeśli chodzi o znaki i nazwy handlowe, patrz Informacje prawne.

<p>FOR: VIRO®</p> <p>LAT.</p> <p>8.75 2.9 VI-14</p> <p>FOR: EURO-PRO®</p>	<p>FOR: WANJIN®</p> <p>LAT.</p> <p>8.8 2.2 WAN-1D</p> <p>FOR: HOOPLY®</p>	<p>FOR: WILKA®</p> <p>LAT.</p> <p>2.55 9 WIL-22</p> <p>SERIE 3600</p>	<p>FOR: YALE®</p> <p>LAT.</p> <p>7.35 2.35 YA-65</p> <p>FOR: MASTER®</p>
---	---	---	--

FOR: YARDENI®			FOR: YETI®
<p>ALP.</p> <p>8.85 2.45 YAR-1</p>	<p>LAT.</p> <p>8.9 2.45 YAR-2</p>	<p>LAT.</p> <p>8.9 2.45 YAR-3</p>	<p>LAT.</p> <p>YAR-4D</p>
			<p>LAT.</p> <p>8.8 2.5 YET-19D</p> <p>FOR: LOB®</p>

FOR: YALE®

<p>LAT.</p> <p>9.37 2.85 YA-81</p>	<p>LAT.</p> <p>8.6 3 YA-280D</p>	<p>LAT.</p> <p>H 9 2.4 YA-281D</p>	<p>LAT.</p> <p>1000 8.8 2.8 YA-282</p>
--	--	--	--

FOR: YALE®

<p>LAT.</p> <p>9 2.8 YA-283D</p>	<p>LAT.</p> <p>2100 9 2.5 YA-286D</p>	<p>LAT.</p> <p>D PB 8.9 2.5 YA-301D</p>	<p>LAT.</p> <p>WG 8.3 2.8 YA-306</p>
--	---	---	--

Concerning the marks and commercial denominations see legal warning.  
 Concerniente a las marcas y denominaciones comerciales ver aviso legal.  
 Marka eta izendapen komertzialiei dagokienez, ikus lege-oharra.  
 Concernant les marques et dénominations commerciales voir la note dans l'index.



Beziehen auf die marke und handelsname sehen sie die notiz im Impressum.  
 Relativamente às marcas e denominações comerciais, ver aviso legal.  
 Jeśli chodzi o znaki i nazwy handlowe, patrz Informacje prawne.





## TUBULAR KEYS

Llaves tubulares  
Hodi formako giltzak

Clés tubulaires  
Stiftzylinderschlüssel

Chaves tubulares  
Klucze rurkowe



FOR: ABSA®

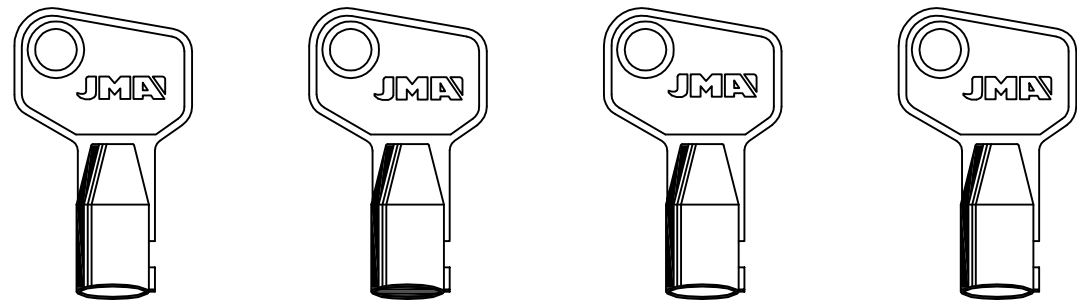

ZAM.

ZAM.

ZAM.

ZAM.

LAT.



AB-1T

FOR: KEYA®

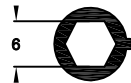

AB-2T

FOR: KEYA®-TOY®

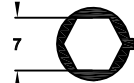

AB-3T

FOR: KEYA®

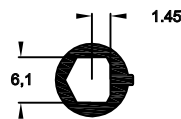

AB-4T

FOR: KEYA®



AGA-1T

FOR: AGA®

FOR: P&C I.®

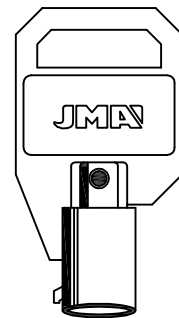

PCI-1T

FOR: P.C.®

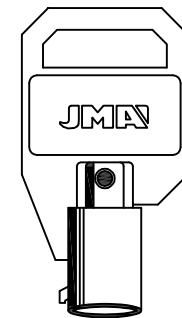

PC-1T

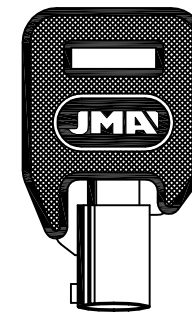

PC-3T.P

FOR: TSAG®

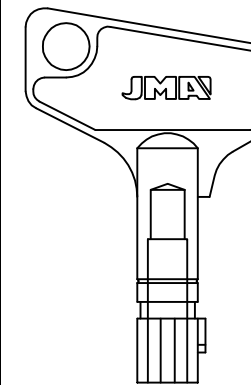

SAG-1T

FOR: AGA®

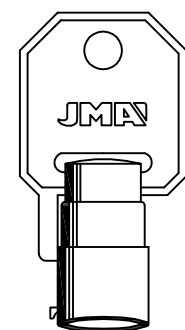

LAT.



AGA-2T

FOR: BARRIER®

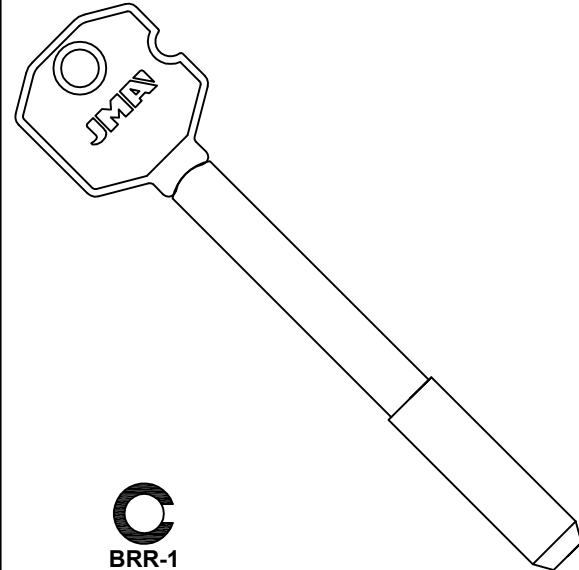

BRR-1

FOR: BILMA®

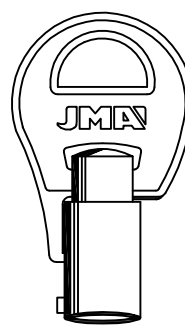

LAT.



BIL-1T

FOR: CHICAGO®

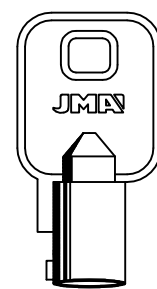

LAT.



CHI-1T

FOR: ACE®-ADEMCO®-AGA®-ALPHA®  
FOR: EURO LOCKS®-FORT®-GELM®-L&F®

FOR: INCECA®

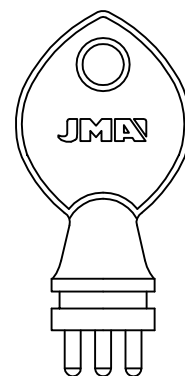

LAT.

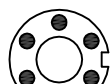

INCE-1E

FOR: LYF®

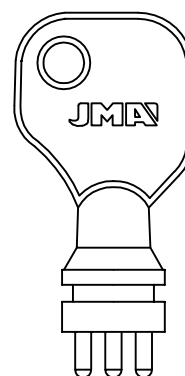

LAT.



INCE-2E

FOR: MERONI®

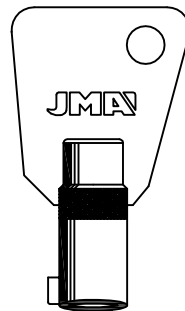

LAT.



LYF-2T

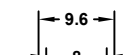
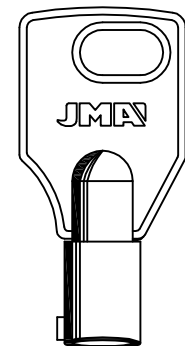

MER-1T

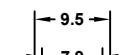
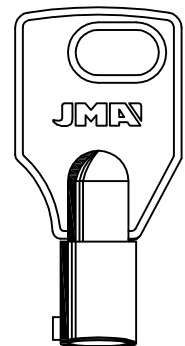

MER-3T

Concerning the marks and commercial denominations see legal warning.

Concerniente a las marcas y denominaciones comerciales ver aviso legal.

Marka eta izendapen komertzialei dagokienez, ikus lege-oharra.

Concernant les marques et dénominations commerciales voir la note dans l'index.





## VEHICLE KEYS

Llaves de vehículos  
Ibilgailuen giltzak

Clés de voitures  
Fahrzeugschlüssel

Chaves de automóveis  
Klucze do pojazdów

FOR: VARIOUS

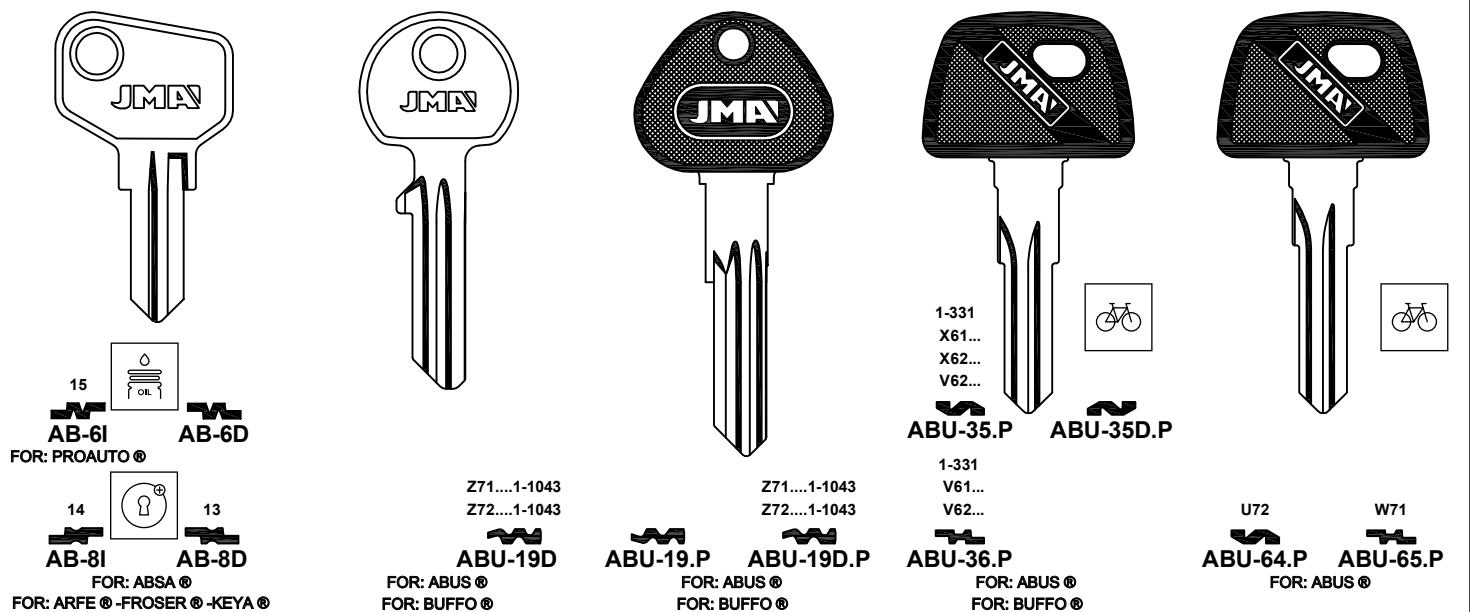

FOR: VARIOUS

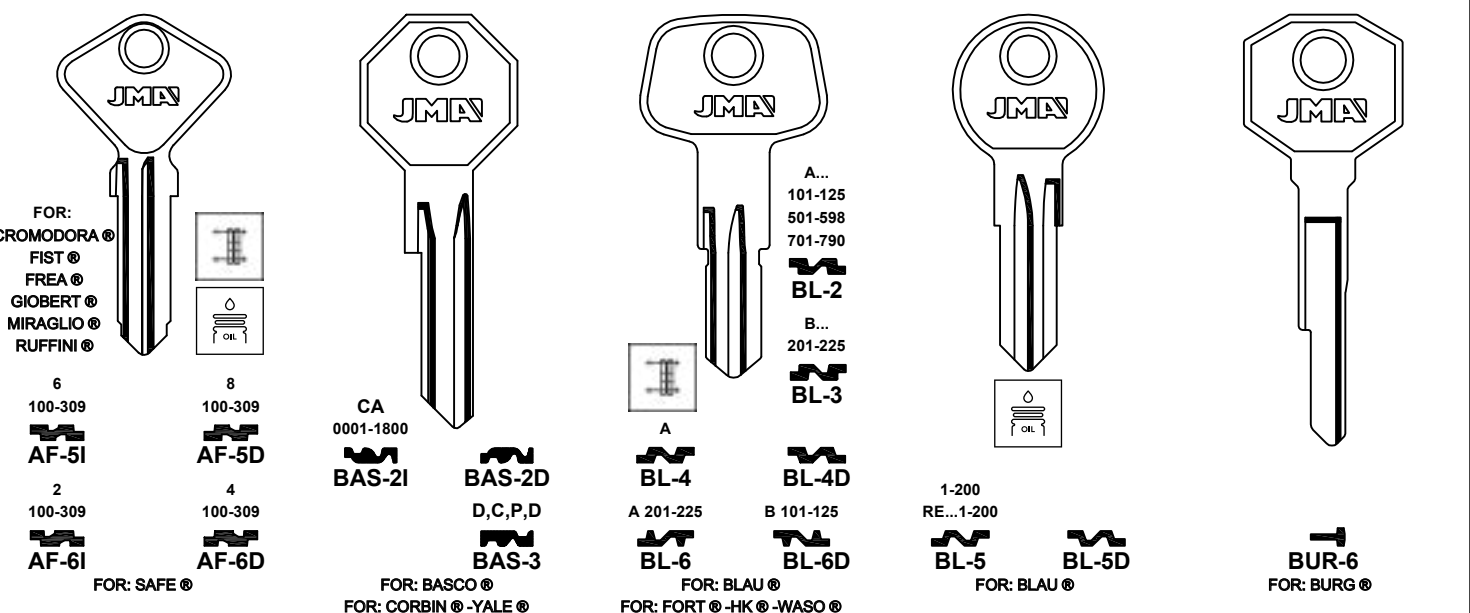

FOR: VARIOUS

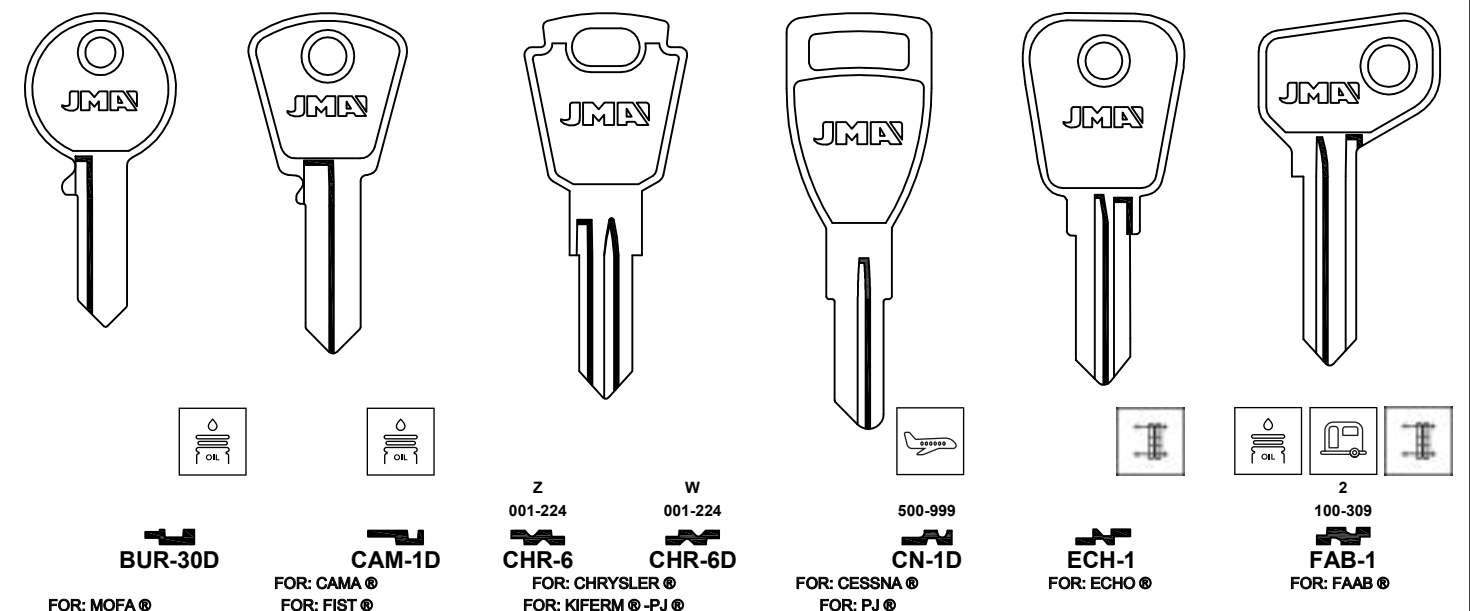

FOR: VARIOUS

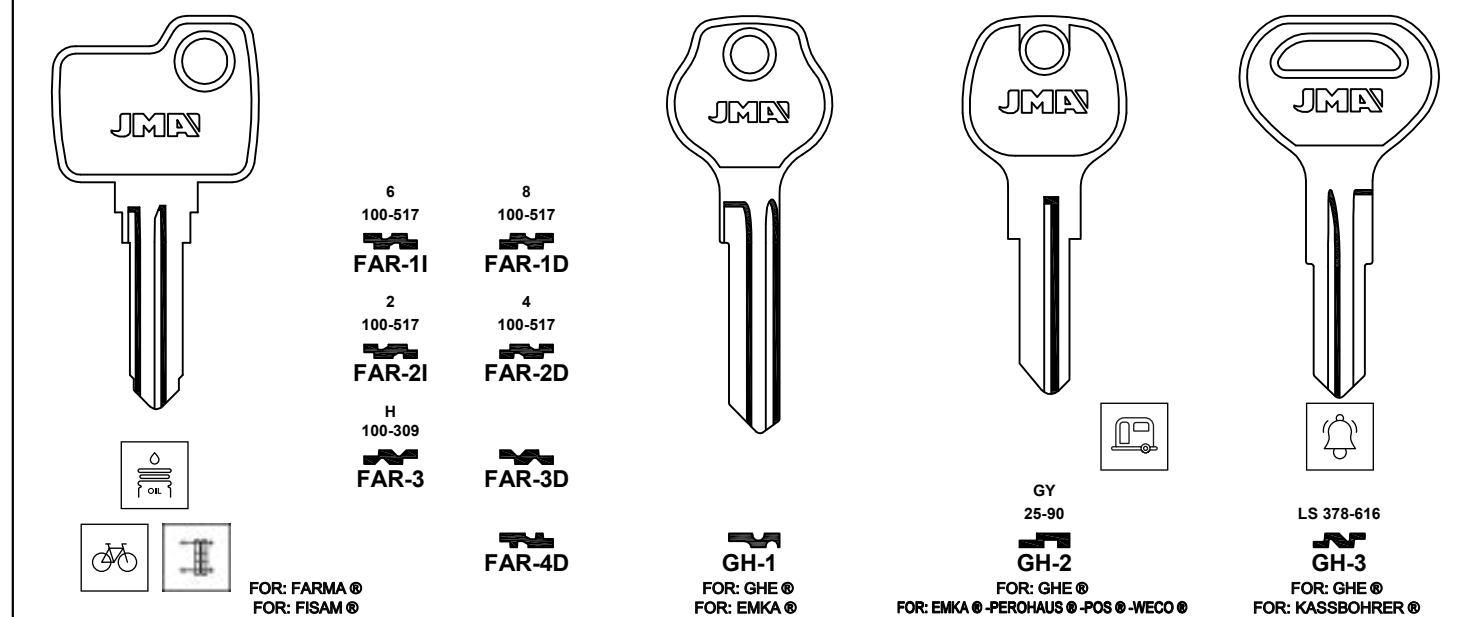

FOR: VARIOUS

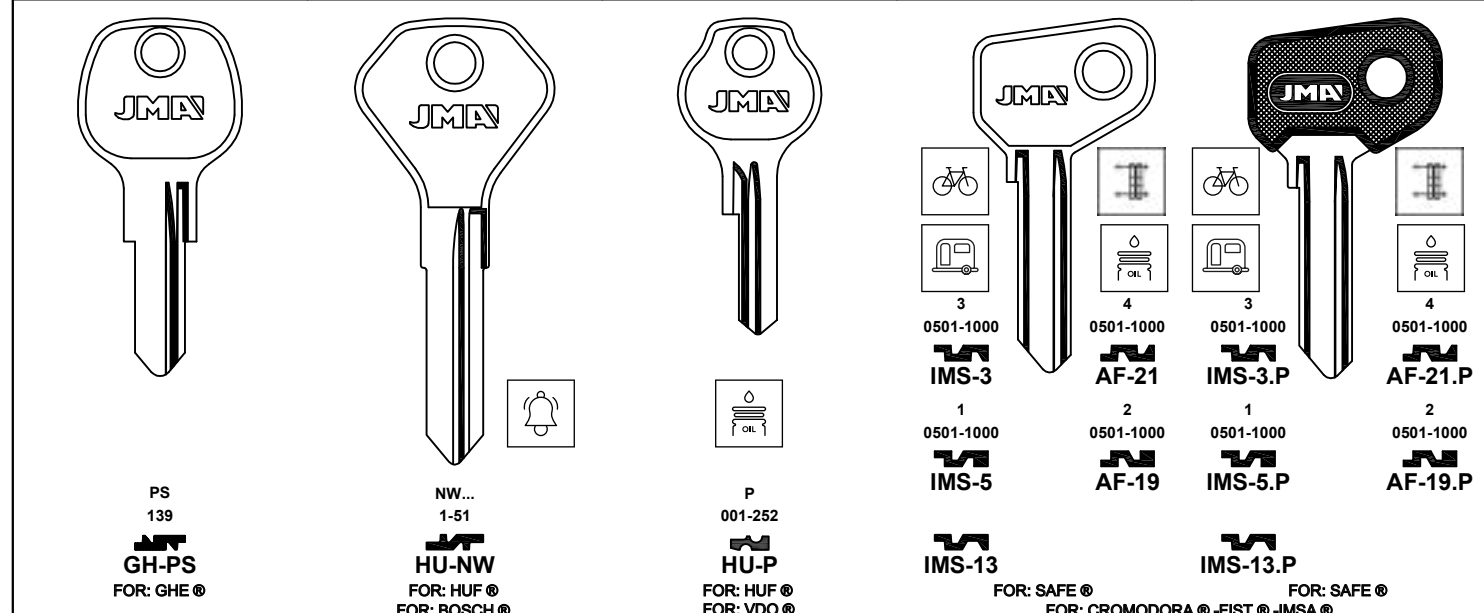

FOR: VARIOUS

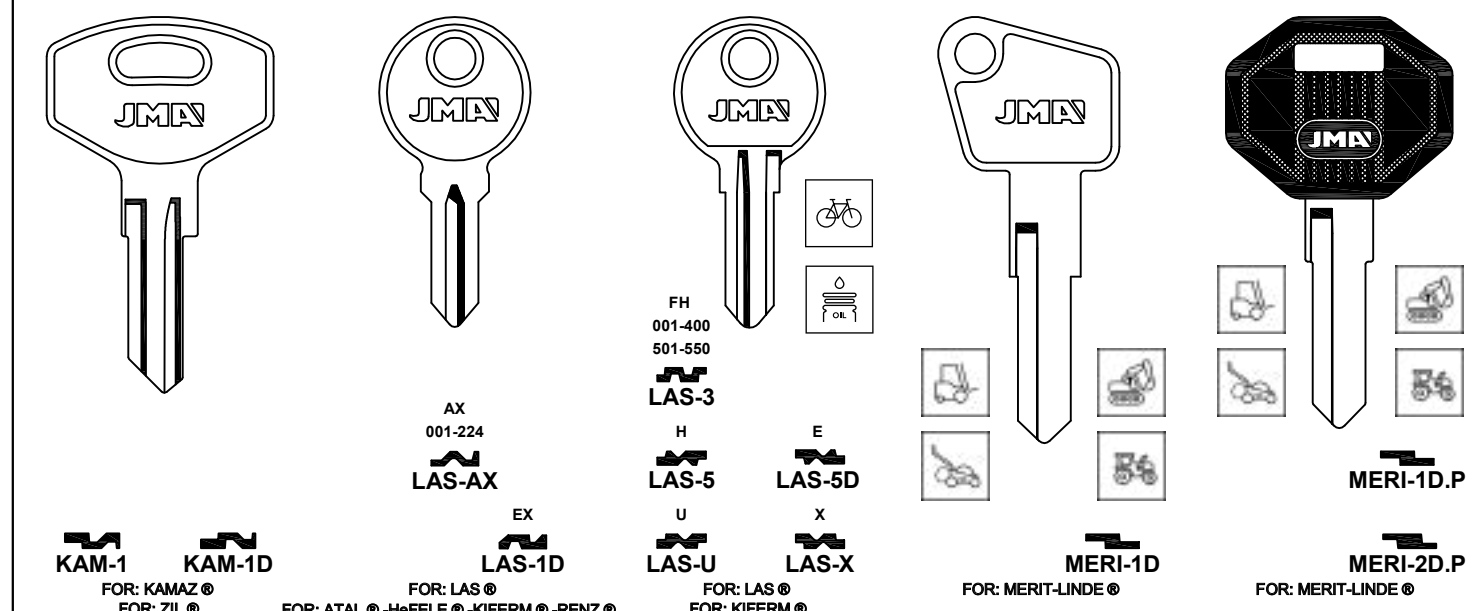

Concerning the marks and commercial denominations see legal warning.  
 Concerniente a las marcas y denominaciones comerciales ver aviso legal.  
 Marka eta izendapen komertzialiei dagokienez, ikus lege-oharra.  
 Concernant les marques et denominations commerciales voir la note dans l'index.

FOR: VARIOUS

MERI-1.P1 MERI-1D.P1  
FOR: MERIT-LINDE®

MOD-1D.P  
FOR: MONDIAL®

NE-1  
FOR: NEIMAN®  
FOR: CLAUSSOR®

NE-1D.P  
FOR: NEIMAN®  
FOR: CLAUSSOR®

NE-2  
FOR: NEIMAN®  
FOR: CLAUSSOR®

FOR: AUDI®  
HONDA®  
MG®  
ROVER®  
BEDFORD®  
FIAT IVECO®  
VOLVO®

FOR: AUDI®  
HONDA®  
MG®  
ROVER®  
BEDFORD®  
FIAT IVECO®  
VOLVO®

...2001-4949  
GM®  
...2001-3000

...2001-4949  
GM®  
...2001-3000

S,T,X,Y  
Z,R  
1-2-3-5-7

FOR: VARIOUS

NE-27  
FOR: NEIMAN®

NE-30  
FOR: NEIMAN®  
FOR: BASTA®

NE-30.P  
FOR: NEIMAN®  
FOR: BASTA®

NE-31  
FOR: NEIMAN®  
FOR: BASTA®

NE-31.P  
FOR: NEIMAN®  
FOR: BASTA®

...1/9...A/Z  
M-N-P-R-S

...1/9...A/Z  
M-N-P-R-S

5001-6278

5001-6278

FOR: VARIOUS

NE-32  
FOR: NEIMAN®  
FOR: BASTA®

NE-32.P  
FOR: NEIMAN®  
FOR: BASTA®

NE-44.P  
FOR: NEIMAN®  
FOR: CLAUSSOR®

NE-48  
FOR: NEIMAN®  
FOR: CLAUSSOR®

NE-49  
FOR: NEIMAN (RA)®

...A/Z  
B-C-D-E  
1/9...A/Z  
1/9...A/Z  
...A/Z  
B-D-E-G-H-J  
.1/9...A/Z  
.1/9...A/Z  
E-M-N-P-R

...A/Z  
A/Z...A/Z  
1 AL 7  
...A/Z  
0 AL 9

FOR: VARIOUS

NE-54.P  
FOR: NEIMAN (RA)®

NE-57  
FOR: NEIMAN®

NE-63D  
FOR: NEIMAN®

OP-1  
FOR: HUF®

M...  
1-2-3-4-5

FOR: VARIOUS

OP-BB  
FOR: HUF®

OP-CC  
FOR: HUF®

OP-DD  
FOR: HUF®

OP-FF  
FOR: HUF®

PRE-21  
FOR: PRESTA®  
FOR: LAPORTE®

SI-1D  
FOR: SISPA®  
FOR: AUTOBLOCK®

CC...501-1000  
CC...1751-2000  
CC...2501-3000

DD...501-1000  
DD...1751-2000  
DD...2501-3000

B...1-380  
BB...501-1000  
BB...1751-2000  
BB...2501-3000

EE...501-1000  
EE...1751-2000  
EE...2501-3000

FF...501-1000  
FF...1751-2000  
FF...2501-3000

...7700-7749

C3..AA-ZY  
D3..AA-HR  
J...1-544

C4..AA-ZY  
D4..AA-HR  
RO-5I  
RO-5D

...1100-1307

FOR: VARIOUS

SI-3  
FOR: SISPA®  
FOR: AUTOBLOCK®

SI-3D  
FOR: SISPA®  
FOR: AUTOBLOCK®

SI-4  
FOR: SISPA®  
FOR: AUTOBLOCK®

SI-4D  
FOR: SISPA®  
FOR: AUTOBLOCK®

SIM-1200  
FOR: ABSA®

SIX-5.P  
FOR: SIMPLEX®  
FOR: CITROEN®

STR-3  
FOR: STREBOR®  
FOR: UNION®

1...  
SI-2D

...1100-1307

8

0111111  
AL  
628888

SF...101-199  
SR...301-399  
SS...201-299  
SO...01-99

Concerning the marks and commercial denominations see legal warning.  
 Concerniente a las marcas y denominaciones comerciales ver aviso legal.  
 Marka eta izendapen komertzialiei dagokienez, ikus lege-oharra.  
 Concernant les marques et denominations commerciales voir la note dans l'index.



FOR: VARIOUS

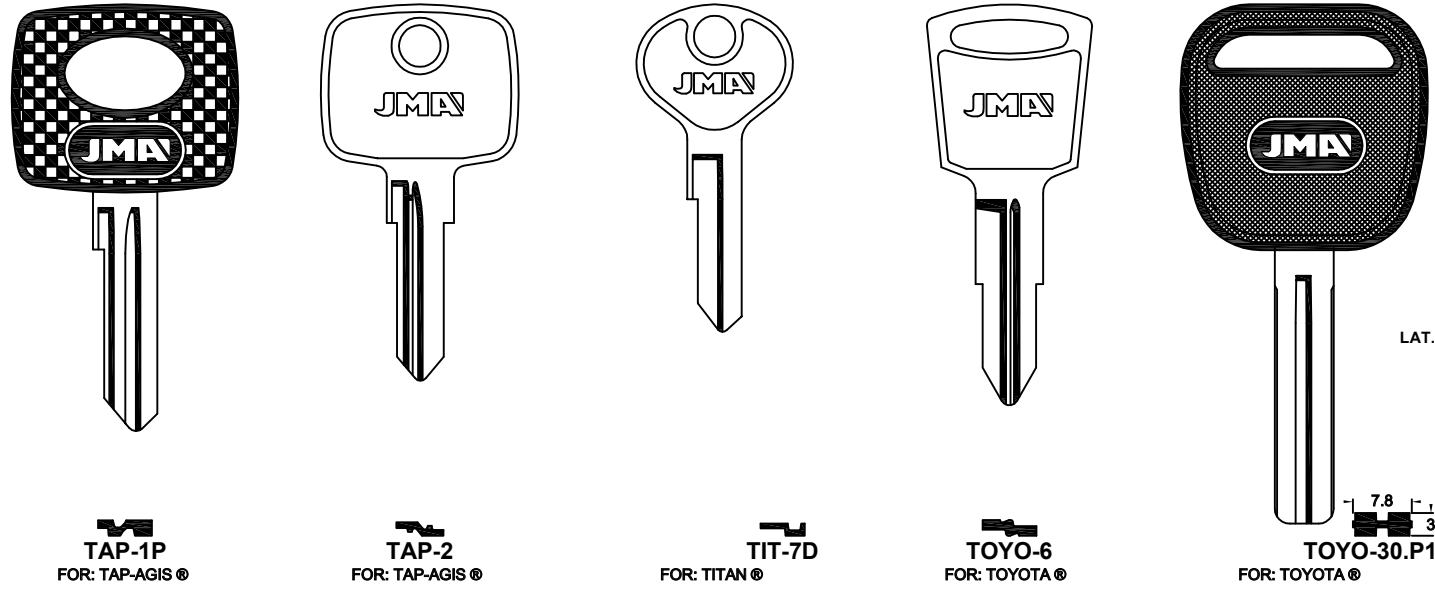

FOR: VARIOUS

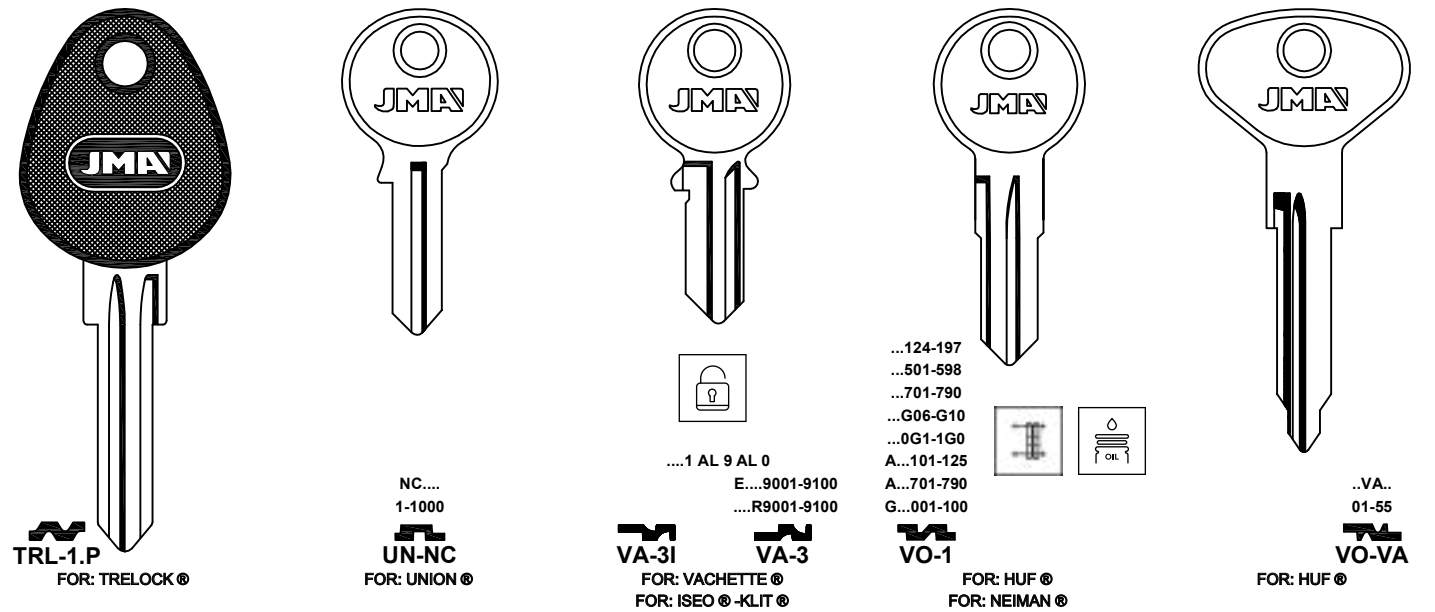

FOR: VARIOUS

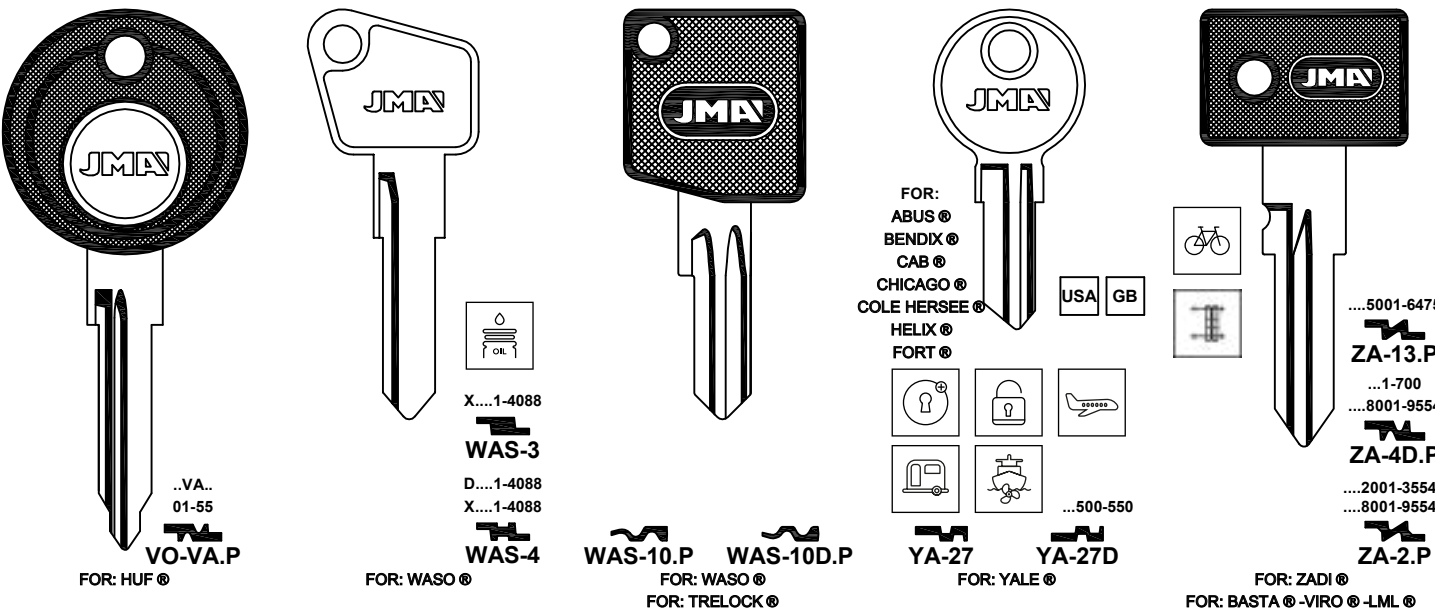

FOR: VARIOUS

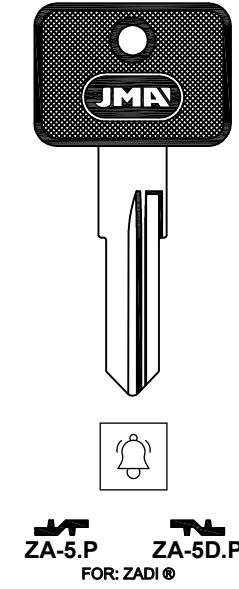

FOR: ABARTH®

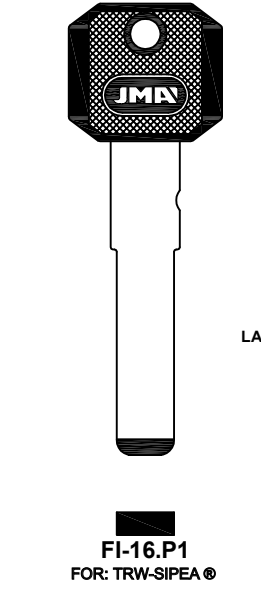

FOR: ABT®

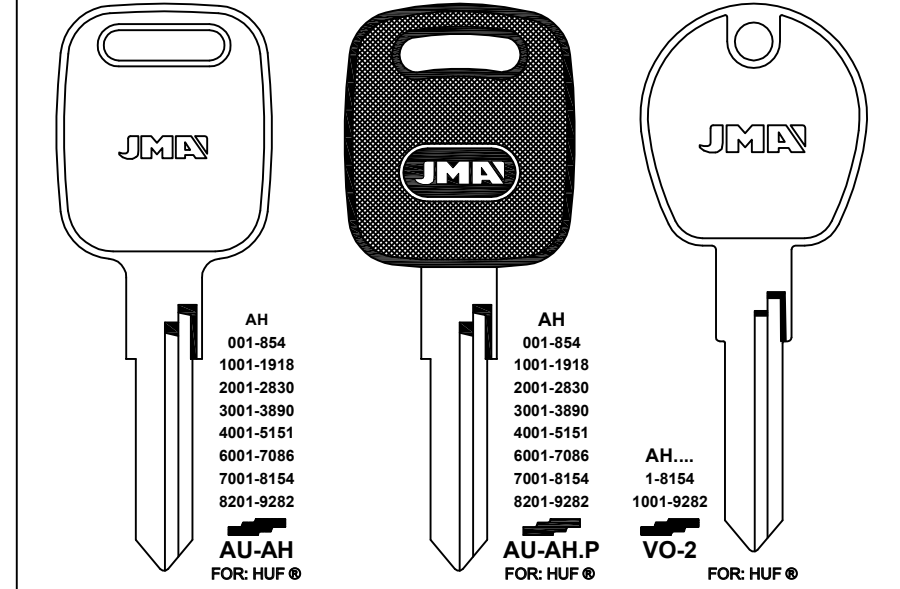

FOR: HUF®

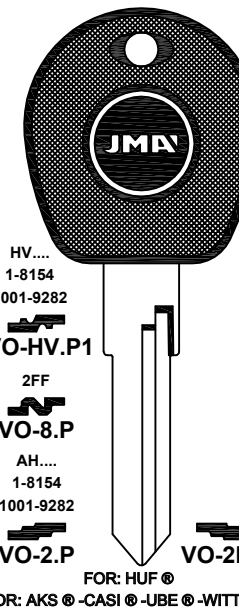

FOR: ACM®

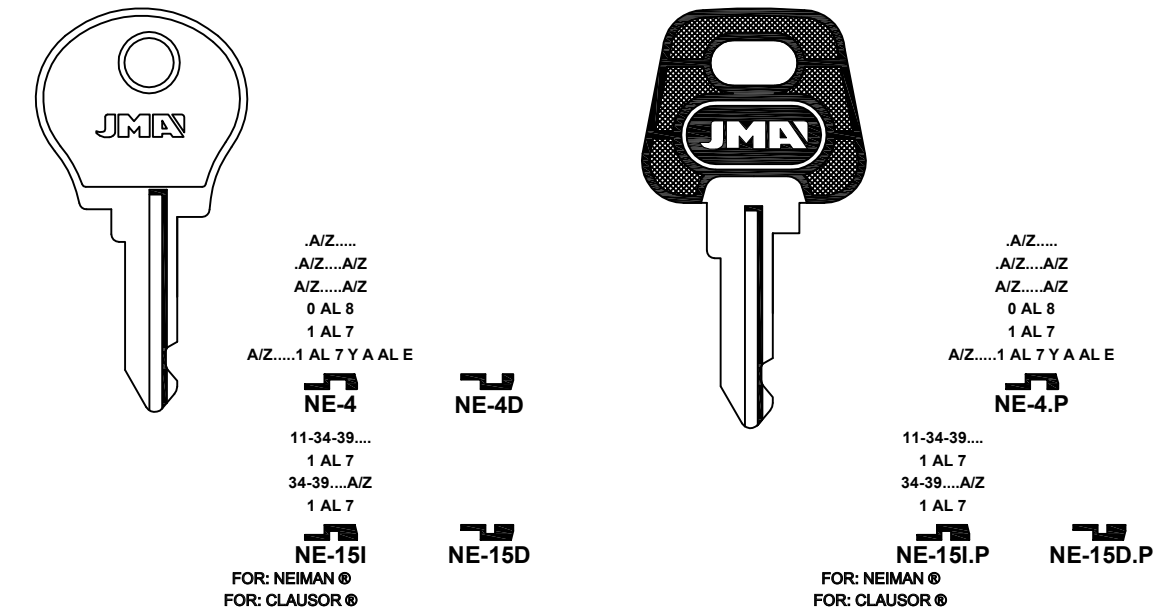

FOR: ACM®

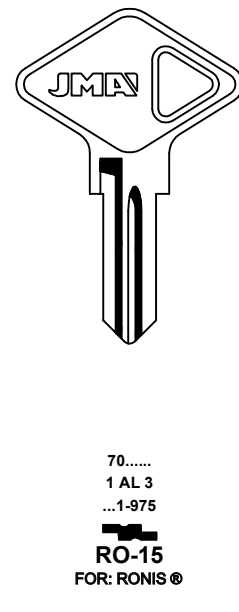

FOR: ACURA (HONDA)®

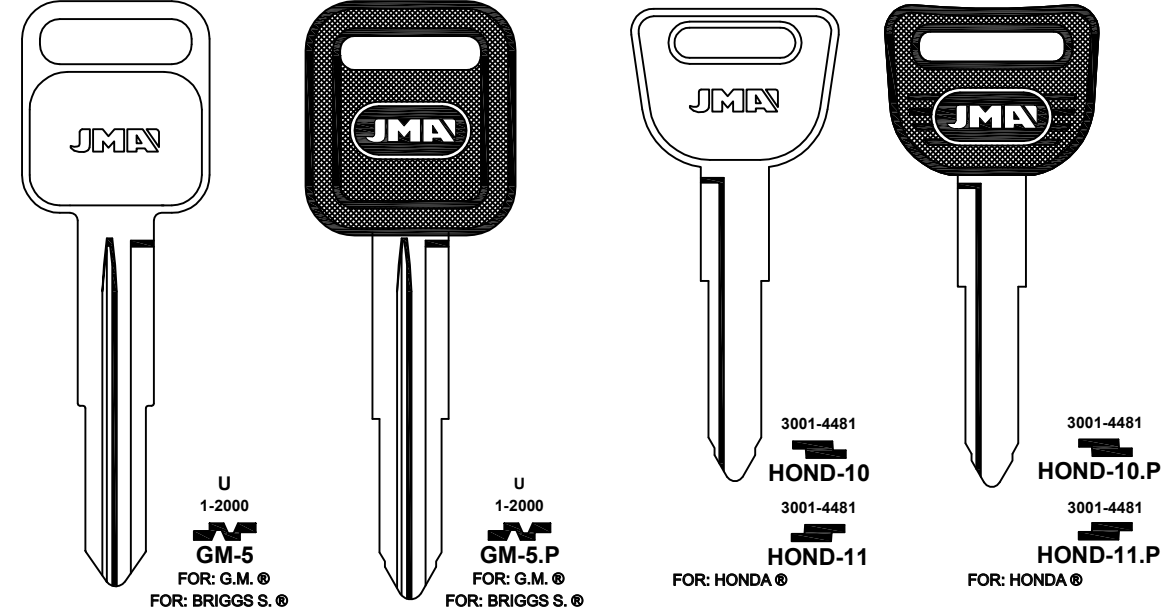

Concerning the marks and commercial denominations see legal warning.  
 Concerniente a las marcas y denominaciones comerciales ver aviso legal.  
 Marka eta izendapen komertzialiei dagokienez, ikus lege-oharra.  
 Concernant les marques et denominations commerciales voir la note dans l'index.

**JMA** Opening the future

**JMA** Opening the future

Beziehen auf die marke und handelsname sehen sie die notiz im Impressum.  
 Relativamente às marcas e denominações comerciais, ver aviso legal.  
 Jeśli chodzi o znaki i nazwy handlowe, patrz Informacje prawne.

FOR: ACURA (HONDA) ®

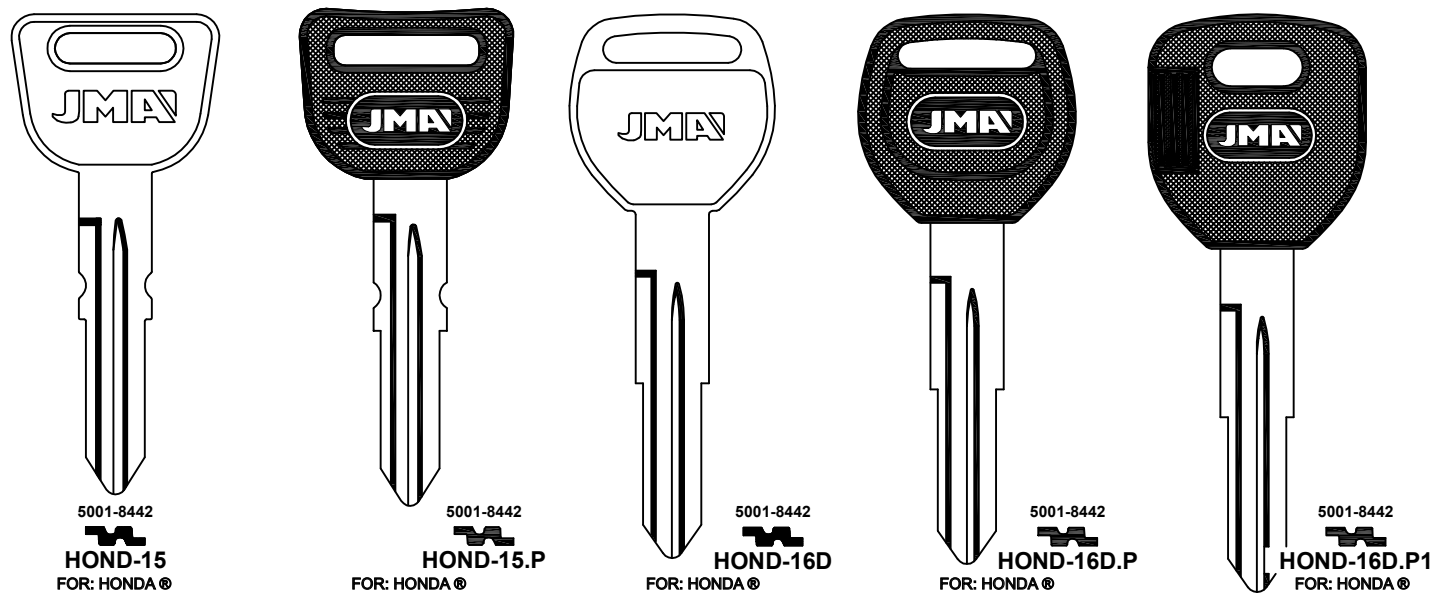

FOR: ACURA (HONDA) ®

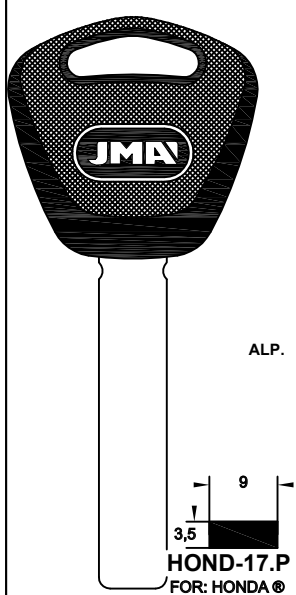

FOR: AIXAM ®

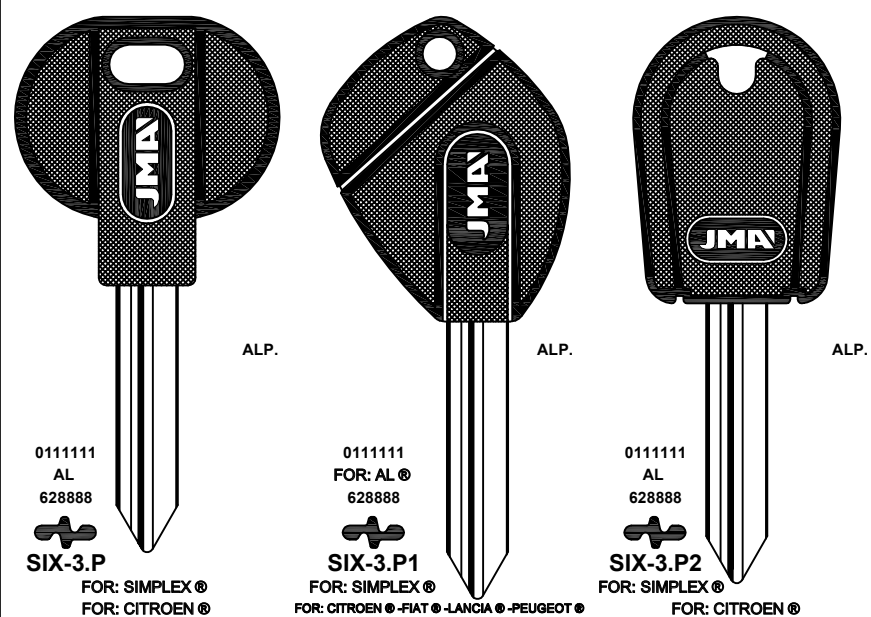

FOR: ALFA ROMEO ®

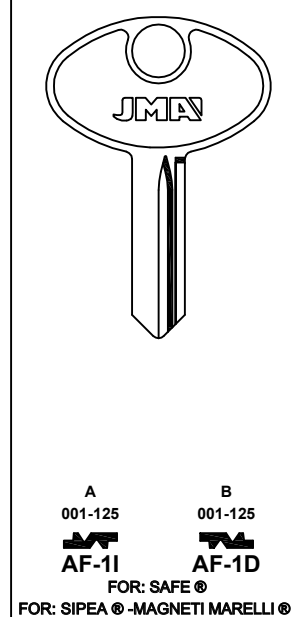

FOR: ALFA ROMEO ®

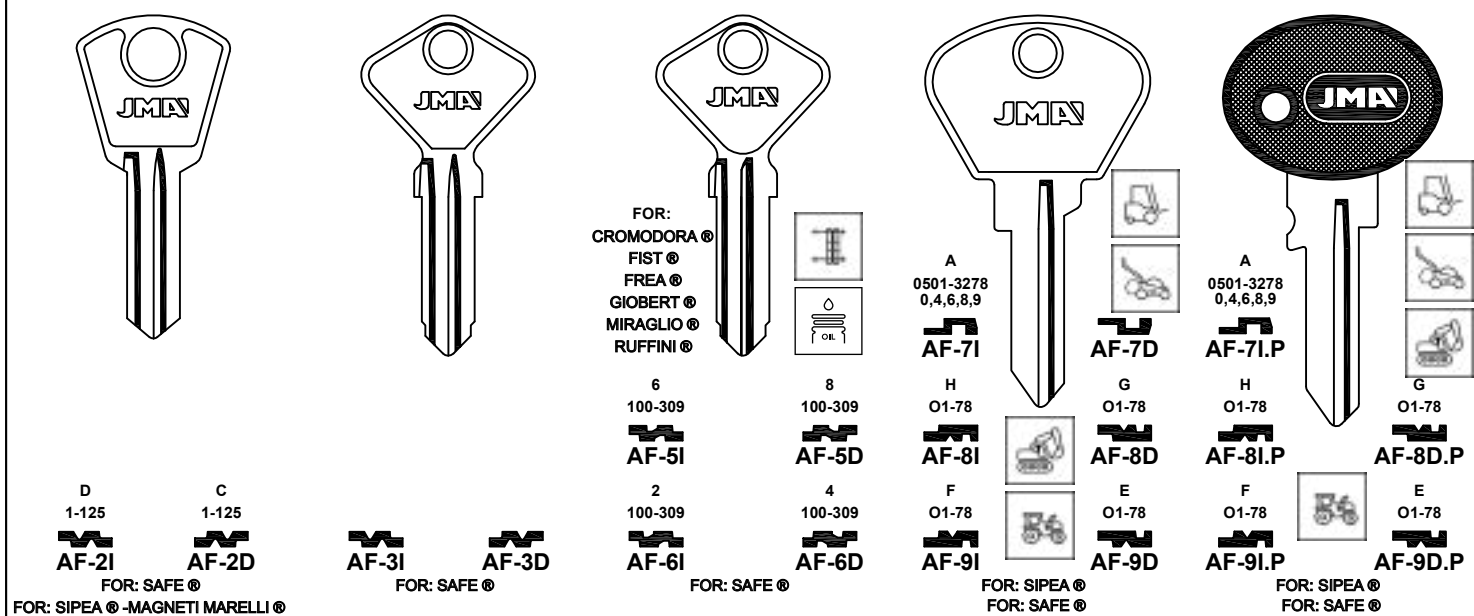

FOR: ALFA ROMEO ®

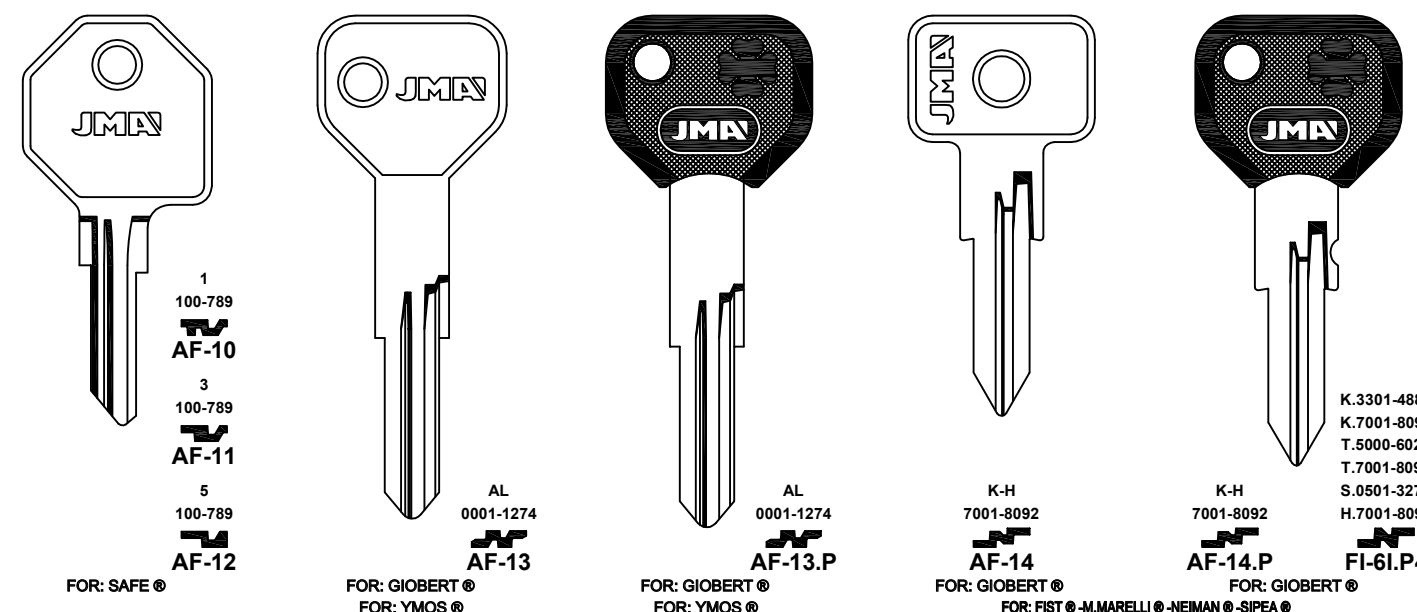

FOR: ALFA ROMEO ®

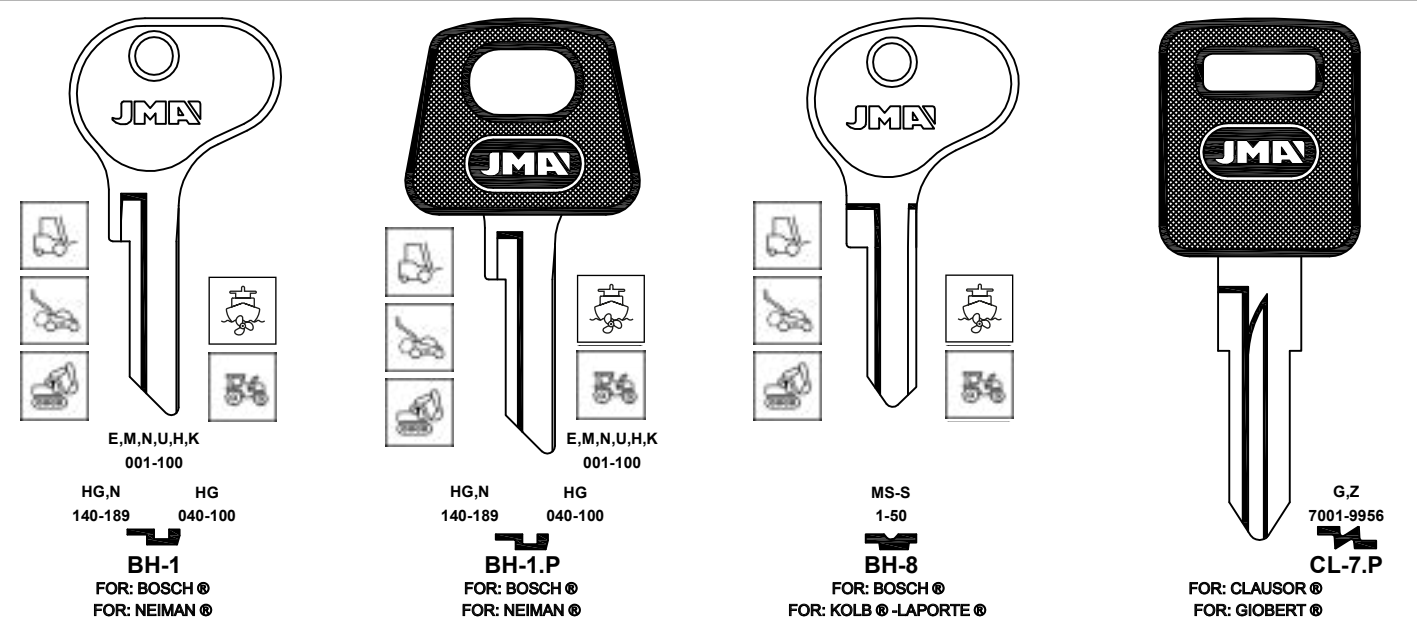

FOR: ALFA ROMEO ®

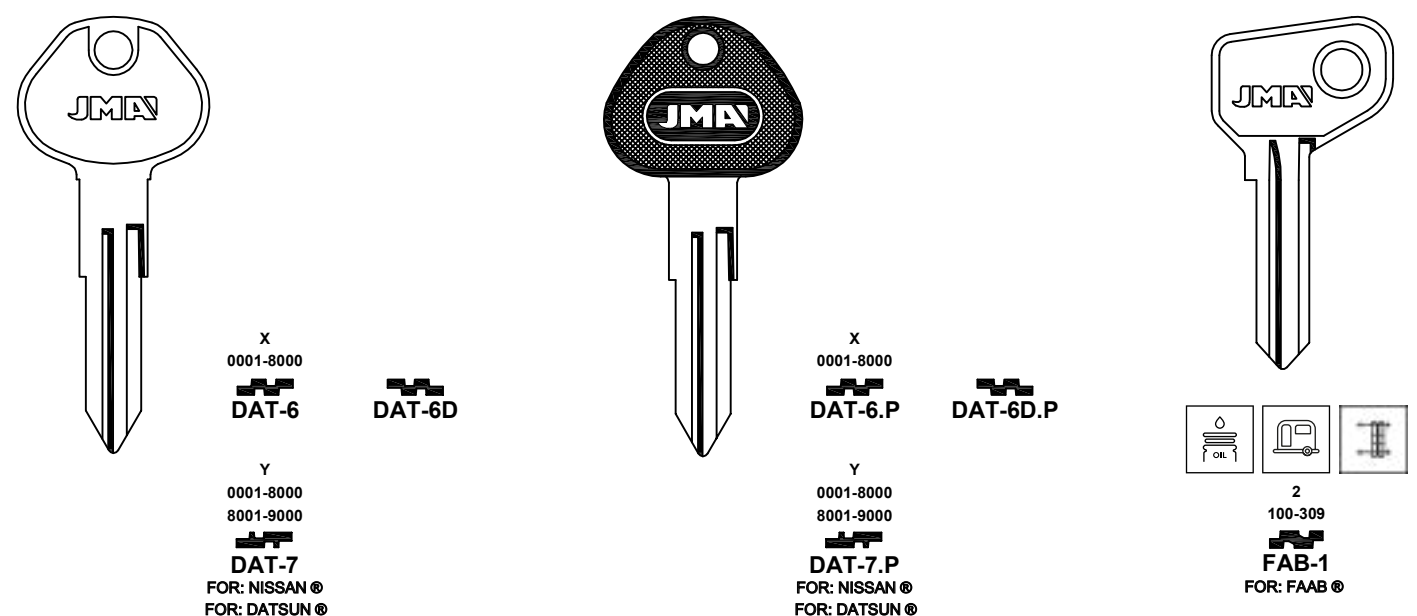

Concerning the marks and commercial denominations see legal warning.  
Concerniente a las marcas y denominaciones comerciales ver aviso legal.  
Marka eta izendapen komertzialiei dagokienez, ikus lege-oharra.  
Concernant les marques et denominations commerciales voir la note dans l'index.

**JMA** Opening the future

**JMA** Opening the future

Beziehen auf die marke und handelsname sehen sie die notiz im Impressum.  
Relativamente às marcas e denominações comerciais, ver aviso legal.  
Jeśli chodzi o znaki i nazwy handlowe, patrz Informacje prawne.



FOR: ALFA ROMEO®

**FI-3**  
 Z-GR  
 7001-9956  
**FI-2D**  
 G  
 2001-4530  
 G-Z  
 7001-9956  
**FI-3D**  
 G  
 7001-9956  
**FI-12**  
 FOR: GIOBERT®  
 FOR: YUGO ZASTAVA® -FIAT IVECO®

**FI-2D.P3**  
 Z-GR  
 7001-9956  
**FI-3D.P3**  
 G  
 2001-4530  
 G-Z  
 7001-9956  
**FI-12.P3**  
 G  
 7001-9956  
 FOR: GIOBERT®

**FI-3D.P**  
 G  
 2001-4530  
 G-Z  
 7001-9956  
**FI-3D.P1**  
 G  
 2001-4530  
 G-Z  
 7001-9956  
**FI-12.P**  
 G  
 7001-9956  
**FI-12.P1**  
 G  
 2001-4530  
 G-Z  
 7001-9956  
**FI-3D.P4**  
 G  
 2001-4530  
 G-Z  
 7001-9956  
 FOR: GIOBERT®

FOR: ALFA ROMEO®  
 CITROEN®  
 FIAT®  
 INNOCENTI®  
 LANCIA®  
 SEAT®

FOR: ALFA ROMEO®  
 FIAT IVECO®

FOR: ALFA ROMEO®

**FI-3D.P5**  
 G  
 2001-4530  
 G-Z  
 7001-9956  
 FOR: GIOBERT®

**FI-6I**  
 FOR: GIOBERT®

**FI-6I.P1**  
 K 3301-4886  
 K 7001-8092  
 T 5000-6027  
 T 7001-8092  
 S 0501-3278  
 H 7001-8092  
 FOR: GIOBERT®

**FI-6I.P2**  
 K 3301-4886  
 K 7001-8092  
 T 5000-6027  
 T 7001-8092  
 S 0501-3278  
 H 7001-8092  
 FOR: GIOBERT®

**FI-9I**  
 M  
 0001-1050  
 FOR: GIOBERT®

FOR:  
 ALFA ROMEO®  
 AUTOBIANCHI®  
 CITROEN®  
 FERRARI®  
 FIAT®  
 INNOCENTI®  
 LANCIA®  
 PEUGEOT®  
 YUGO ZASTAVA®  
 CAGIVA®  
 DUCATI®  
 FANTIC MOTOR®  
 GARELLI®  
 GILERA®

FOR:  
 FERRARI®  
 FIAT®  
 CAGIVA®

FOR: ALFA ROMEO®

**FI-9I.P**  
 M  
 0001-1050  
 FOR: GIOBERT®

**FI-13**  
 W  
 0001-9640  
 FOR: GIOBERT®

**FI-13.P**  
 W  
 0001-9640  
 FOR: GIOBERT®

**FI-13.P1**  
 W  
 0001-9640  
 FOR: GIOBERT®

**FI-13.P7**  
 W  
 0001-9640  
 FOR: GIOBERT®  
 FOR: SIPEA®

FOR: ALFA ROMEO®

**FI-14.P**  
 W  
 0001-9640  
 FOR: GIOBERT®

**FI-16.P1**  
 FOR: TRW-SIPEA®  
 FOR: GIOBERT®

**GIOB-3.P2**  
 ALP.  
 ALFA ROMEO®  
 LA FORZA®  
 LANCIA®  
 RAYTON FISSORE®  
 0001-1530  
 FOR: GIOBERT®  
 FOR: SAFE®

**IMS-3**  
 0501-1000  
**AF-21**  
 0501-1000  
**IMS-5**  
 0501-1000  
**IMS-13**  
 FOR: SAFE®  
 FOR: CROMODORA® -FIST® -IMSA®

**IMS-3.P**  
 0501-1000  
**AF-21.P**  
 0501-1000  
**IMS-5.P**  
 0501-1000  
**IMS-13.P**  
 FOR: SAFE®

FOR: GIOBERT®

FOR: ALFA ROMEO®

**NE-13**  
 .....E  
 E.....  
 N.....  
 X.....  
 1 AL 5  
 FOR: NEIMAN®

**NE-25**  
 .....A  
 .....D  
 .....F  
 1 AL 5  
 FOR: NEIMAN®

**SIP-3**  
 B.....501-3278  
 B.....0-4-6-8-9  
 FOR: SIPEA®  
 FOR: ARTEB® -CLAUSOR® -NEIMAN®

FOR: AMERICAN MOTORS®

**AMM-1**  
 FOR: AMERICAN MOT.®

**AMM-2**  
 FOR: AMERICAN MOT.®

FOR: AMERICAN MOTORS®

**BAS-1I**  
 E,D  
 225-814  
 K  
 0001-1000  
 FOR: BASCO®  
 FOR: CORBIN®

**BAS-1D**  
 8000-9499  
 FOR: CORBIN®

**BS-11**  
 N  
 1501-1700  
 NA  
 001-200  
 FOR: B & S®

**BS-2**  
 E...225-814  
 L...1-1000  
 FOR: B & S®

**BS-5**  
 D  
 225-814  
 K  
 01-1000  
 FOR: B & S®

**CHR-3**  
 .....  
 .....A/Z  
 B-C-D-E  
 1/9...A/Z  
 1/9...A/Z  
 .....A/Z  
 B-D-E-G-H-J  
 .1/9...A/Z  
 .1/9...A/Z  
 E-M-N-P-R  
 FOR: CHRYSLER®  
 FOR: CLAUSOR® -NEIMAN®

FOR:  
 A.MOTORS®  
 CITROEN®  
 MAZDA®  
 PEUGEOT®  
 RENAULT®  
 TALBOT®  
 DAF®  
 NISSAN®  
 PEGASO®

Concerning the marks and commercial denominations see legal warning.  
 Concerniente a las marcas y denominaciones comerciales ver aviso legal.  
 Marka eta izendapen komertzialiei dagokienez, ikus lege-oharra.  
 Concernant les marques et denominations commerciales voir la note dans l'index.

**JMA** Opening the future

**JMA** Opening the future

Beziehen auf die marke und handelsname sehen sie die notiz im Impressum.  
 Relativamente às marcas e denominações comerciais, ver aviso legal.  
 Jeśli chodzi o znaki i nazwy handlowe, patrz Informacje prawne.













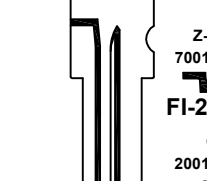
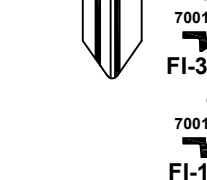
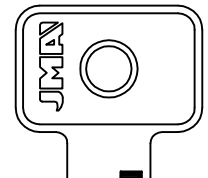
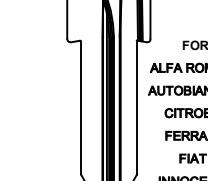
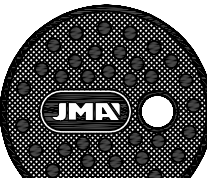
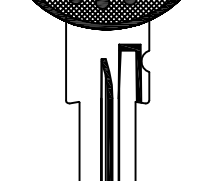
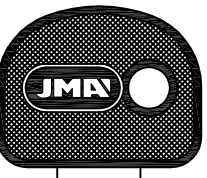
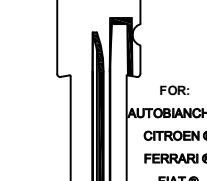
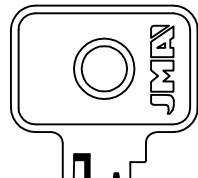
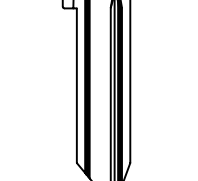





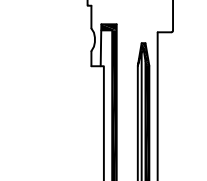
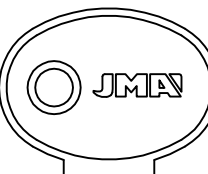
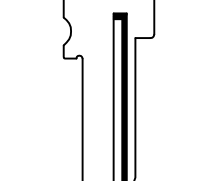

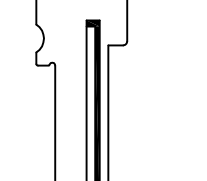
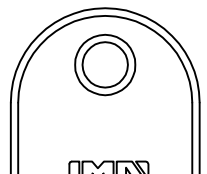
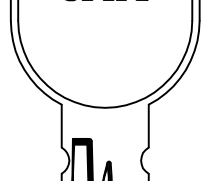
FOR: AUTOBIANCHI®

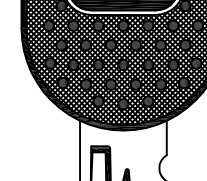
 Z-GR 7001-9956  G 2001-4530 G-Z 7001-9956  G 7001-9956 FOR: GIOBERT®	 FOR: ALFA ROMEO® AUTOBIANCHI® CITROEN® FERRARI® FIAT® INNOCENTI® LANCIA® PEUGEOT® YUGO ZASTAVA® CAGIVA® DUCATI® FANTIC MOTOR® GARELLI® GILERA® K 3301-4886 K 7001-8092 T 5000-6027 T 7001-8092 S 0501-3278 H 7001-8092  FOR: GIOBERT®	 K 3301-4886 K 7001-8092 T 5000-6027 T 7001-8092 S 0501-3278 H 7001-8092  FOR: GIOBERT®	 FOR: AUTOBIANCHI® CITROEN® FERRARI® FIAT® LANCIA® PEUGEOT® YUGO ZASTAVA® CAGIVA® DUCATI® FANTIC MOTOR® GARELLI® GILERA® K 3301-4886 K 7001-8092 T 5000-6027 T 7001-8092 S 0501-3278 H 7001-8092  FOR: GIOBERT®	 Y 7001-9956  FOR: GIOBERT® FOR: ARMAN®
--	---	---	--	--

FOR: AUTOBIANCHI®

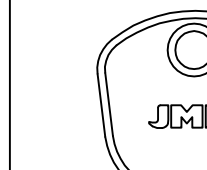
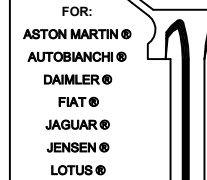

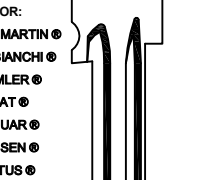
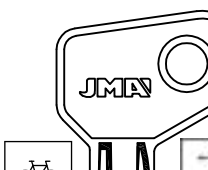
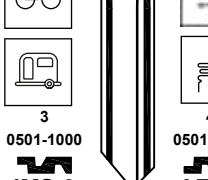
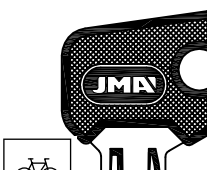
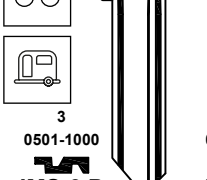

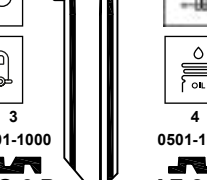
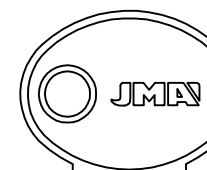
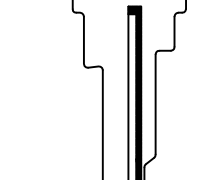
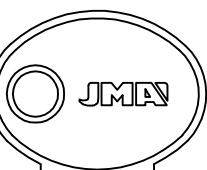
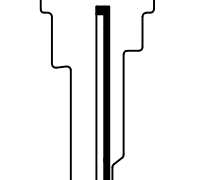
 Y 7001-9956  FOR: GIOBERT® FOR: ARMAN®	 M 0001-1050  FOR: GIOBERT®	 M 0001-1050  FOR: GIOBERT®	 N 6001-7000 J 3001-6732 V 0001-3051 V 5001-8058 AB 6001-6891  FOR: GIOBERT®	 N 6001-7000 J 3001-6732 V 0001-3051 V 5001-8058 AB 6001-6891  FOR: GIOBERT®
---	--	--	--	--

FOR: AUTOBIANCHI®

 FOR: ASTON MARTIN® AUTOBIANCHI® DAIMLER® FIAT® JAGUAR® JENSEN® LOTUS® PREMIER® SEAT® TRIUMPH® YUGO ZASTAVA® SCANIA® FK 1-3040 4001-6000  FOR: FORD®	 FOR: ASTON MARTIN® AUTOBIANCHI® DAIMLER® FIAT® JAGUAR® JENSEN® LOTUS® PREMIER® SEAT® TRIUMPH® YUGO ZASTAVA® SCANIA® FK 1-3040 4001-6000  FOR: FORD®	 3 0501-1000  FOR: SAFE®	 4 0501-1000  FOR: SAFE®	 3 0501-1000  FOR: SAFE®	 4 0501-1000  FOR: SAFE®	 B....501-3278 B.....0-4-6-8-9  FOR: SIPEA®
--	--	--	--	--	--	---

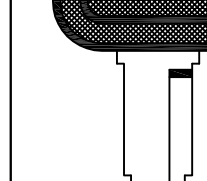
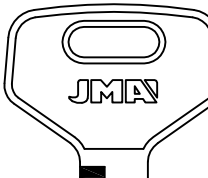
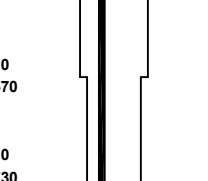
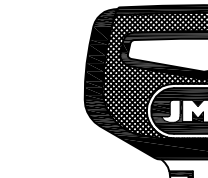
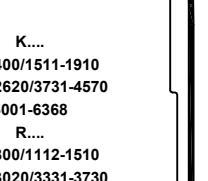
Concerning the marks and commercial denominations see legal warning.  
 Concerniente a las marcas y denominaciones comerciales ver aviso legal.  
 Marka eta izendapen komertzialiei dagokienez, ikus lege-oharra.  
 Concernant les marques et denominations commerciales voir la note dans l'index.

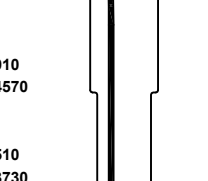

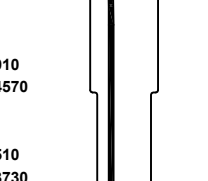

FOR: BEDFORD®

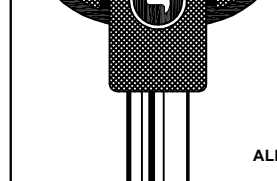
 U 7001-8200  FOR: G.M.® FOR: BRIGGS STRATTON®	 K.... 001-400/1511-1910 2221-2620/3731-4570 5001-6368 R.... 401-800/1112-1510 2621-3020/3331-3730 5001-6924/8001-9368 S.... 5951-6350/7061-7460 8171-8570/9281-9680 D.... 6001-7042  FOR: TOYOTA® FOR: TOKAJ® -RIKA®	 F.... 5951-6350 7061-7460 8171-8570 9281-9680 P.... 7001-8500  FOR: TOYOTA® FOR: TOKAJ® -RIKA®	 K.... 001-400/1511-1910 2221-2620/3731-4570 5001-6368 R.... 401-800/1112-1510 2621-3020/3331-3730 5001-6924/8001-9368 S.... 5951-6350/7061-7460 8171-8570/9281-9680 D.... 6001-7042  FOR: TOYOTA® FOR: TOKAJ® -RIKA®	 F.... 5951-6350 7061-7460 8171-8570 9281-9680 P.... 7001-8500  FOR: TOYOTA® FOR: TOKAJ® -RIKA®
---	---	---	---	---

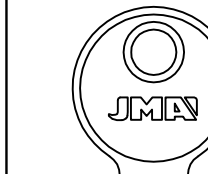
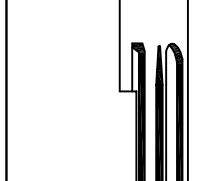
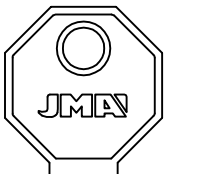
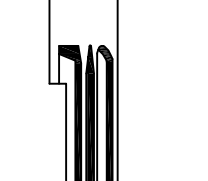
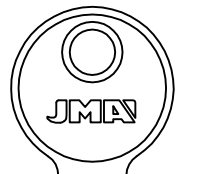
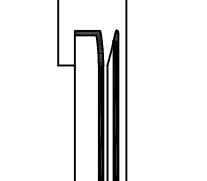

FOR: BELLIER®

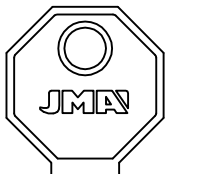
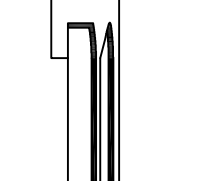
  
 0111111  
AL  
628888  
  
 FOR: SIMPLEX®

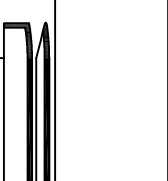

FOR: BENTLEY®

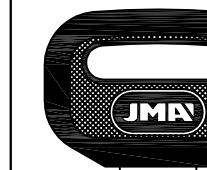
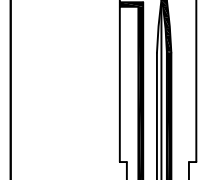
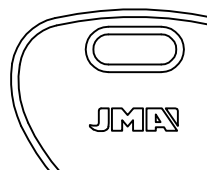
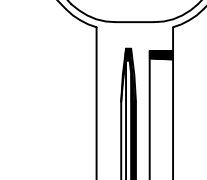
 RRL  FOR: YALE®	 RRM  FOR: YALE®	 NRRL  FOR: YALE®	 NRRL  FOR: YALE®	 NRRM  FOR: YALE®	 NRRM  FOR: YALE®
--	--	---	---	---	---

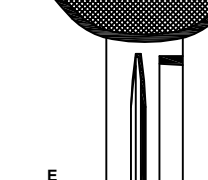
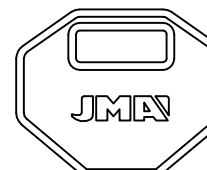
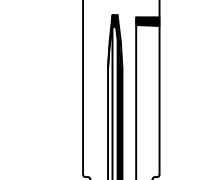
FOR: BERTONE®

 D 0001-2000  FOR: DAIHATSU®	 E 5001-7000  FOR: MITSUBISHI®	 E 5001-7000 7001-7679  FOR: MITSUBISHI®	 E 5001-7679  FOR: MITSUBISHI®
--	--	---	--

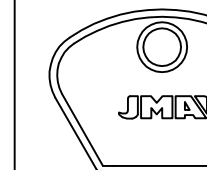
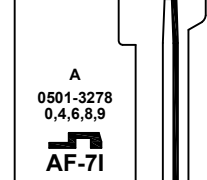
FOR: BMA®

 A 0501-3278 0,4,6,8,9  FOR: SIPEA® FOR: SAFE®	 G O1-78  FOR: SIPEA® FOR: SAFE®
--	---

Beziehen auf die marke und handelsname sehen sie die notiz im Impressum.  
 Relativamente às marcas e denominações comerciais, ver aviso legal.  
 Jeśli chodzi o znaki i nazwy handlowe, patrz Informacje prawne.

FOR: BMA®

A  
0501-3278  
0,4,6,8,9  
AF-71.P  
H  
01-78  
AF-81.P  
F  
01-78  
AF-91.P  
FOR: SIPEA®  
FOR: SAFE®

F  
01-78  
FEM-11  
H  
01-78  
FEM-21  
E  
01-78  
FEM-1D  
G  
01-78  
FEM-2D  
FEM-31  
FEM-3D  
FOR: FEMSA®

NRA  
FFE...1-100  
FJA...1-100  
FL...251-500  
NRA...51-90  
YFB...1-75  
FMD...1-75  
FG...1-30  
NF...1-30  
EJR...1-75  
UN-FFE  
UN-3  
UN-FP  
MC...1-40  
MRA...251-290  
MRN...1-54  
MRN...201-250  
MRN...251-300  
UN-MRN  
UN-2  
UN-FR  
FA...  
501-625  
UN-44  
FOR: UNION®

FP...  
626-750  
UN-FP  
FR...  
751-875  
UN-FR  
HX...100  
UN-2  
UN-FR  
RM...  
911-952  
UN-44D  
UN-NG  
NGN...1-54  
UN-NG  
FOR: UNION®

FOR: BMW®

BM-1.P  
7.49  
2.7  
0001-1100  
FOR: HUF®  
FOR: PEBRA®

FOR: BMW®

HB 1-5000  
BM-HB  
FOR: HUF®

NB 1-5000  
BM-NB  
FOR: HUF®

HB 1-5000  
BM-HB.P  
FOR: HUF®

NB 1-5000  
BM-NB.P  
FOR: HUF®

W 1001-2020  
7001-8000  
BM-W  
FOR: HUF®

SR 001-240  
KSR 001-240  
LSR 001-240  
TSR 001-240  
HU-SR  
SU 001-240  
401-630  
HU-SU  
SX 001-240  
HU-SX  
SY 001-240  
001-240  
HU-SY  
SZ 1-240  
HU-SZ  
FOR: HUF®  
FOR: AKS®

SE 001-750  
SC 401-630  
HU-SC  
FOR: HUF®

FOR: BMW®

HB 10001-20000  
40001-49999  
BM-2  
FOR: HUF®

HB 10001-20000  
40001-49999  
BM-2.P  
FOR: HUF®  
FOR: MAKERSAN®

FOR: HB 1-5000  
BM-3  
FOR: HUF®

HB 1-5000  
BM-3.P  
FOR: HUF®

BH 010001-241009  
7.2  
3.5  
BM-4  
FOR: HUF®  
FOR: TIBBE®

FOR: BMW (USA)®

8.2  
2.95  
BM-6.P  
FOR: HUF®

LAT.  
PARA FOR BM-6RKE TP  
ALP.  
8.2  
2.95  
BM-6.P1C1  
FOR: HUF®

FOR: BRITISH LEYLAND®

SF...101-199  
SR...301-399  
SS...201-299  
SO...01-99  
STR-3  
FOR: STREBOR®  
FOR: UNION®

FS...1-99  
FS...876-955  
UN-1FS  
FOR: HUF®

FA...  
501-625  
UN-44  
FOR: UNION®

RM...  
911-952  
UN-44D  
UN-NG  
FOR: UNION®

NRA  
FFE...1-100  
FJA...1-100  
FL...251-500  
NRA...51-90  
YFB...1-75  
FMD...1-75  
FG...1-30  
NF...1-30  
EJR...1-75  
UN-FFE  
UN-3  
UN-FP  
MC...1-40  
MRA...251-290  
MRN...1-54  
MRN...201-250  
MRN...251-300  
UN-MRN  
UN-2  
UN-FR  
HX...100  
UN-2  
UN-FR  
FR...  
751-875  
UN-FR  
NGN...1-54  
UN-NG  
FOR: UNION®

FOR: BMW®

7.2  
3.5  
BM-5.P  
FOR: HUF®  
FOR: TIBBE®

8.2  
2.95  
BM-6.P  
FOR: HUF®

8.2  
2.95  
BM-6.P1C1  
FOR: HUF®

B 101-300  
401-630  
BM-B  
FOR: HUF®  
FOR: WITTE®

FOR: CARBODIES®

FOR: ASTON MARTIN®  
JAGUAR®  
LAND ROVER  
MG®  
ROVER®  
VOLVO®  
FP 626-750  
IN-1  
FS 01-99  
876-955  
IN-4  
FR 751-875  
UN-4  
FOR: UNION®

FOR: AUSTIN®  
CARBODIES®  
INNOCENTI®  
LAND ROVER  
LOTUS®  
MASERATI®  
OM IVECO®  
ROVER®  
VAUXHALL®  
BEDFORD®  
FIAT IVECO®  
FOR: L. & F.®

FOR: AUSTIN®  
CARBODIES®  
INNOCENTI®  
LAND ROVER  
LOTUS®  
MASERATI®  
OM IVECO®  
ROVER®  
VAUXHALL®  
BEDFORD®  
FIAT IVECO®  
RO BL...N 1001-2000  
LF-RO  
FOR: L. & F.®

FK... 01-99  
876-955  
UN-FK  
FOR: UNION®

FS... 01-99  
876-955  
UN-FS  
FOR: WBH®

0111111  
AL 628888  
SIX-3.P  
FOR: SIMPLEX®

FOR: CHATENET®

Concerning the marks and commercial denominations see legal warning.  
 Concerniente a las marcas y denominaciones comerciales ver aviso legal.  
 Marka eta izendapen komertzialiei dagokienez, ikus lege-oharra.  
 Concernant les marques et denominations commerciales voir la note dans l'index.



FOR: CHEVROLET®

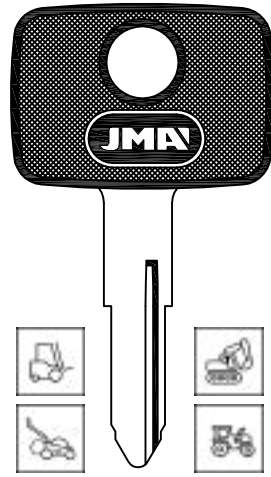

**DAE-5.P**  
FOR: DAEWOO®

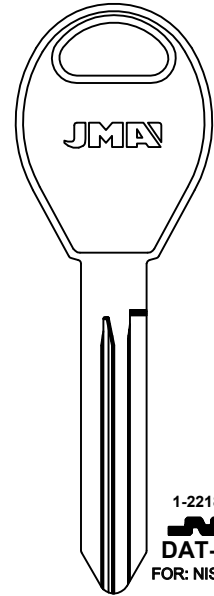

1-22185  
**DAT-16**  
FOR: NISSAN®

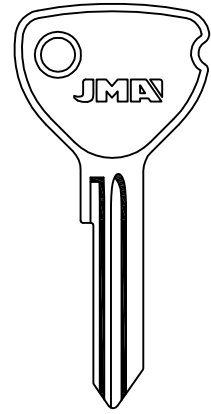

B...1-380  
BB...501-1000  
BB...1751-2000  
BB...2501-3000  
**OP-BB**

CC...501-1000  
CC...1751-2000  
CC...2501-3000



**OP-CC**

EE...501-1000  
EE...1751-2000  
EE...2501-3000



**OP-EE**

FOR: HUF®

DD...501-1000  
DD...1751-2000  
DD...2501-3000



**OP-DD**

FF...501-1000  
FF...1751-2000  
FF...2501-3000



**OP-FF**

FOR: HUF®

FOR: CHRYSLER®

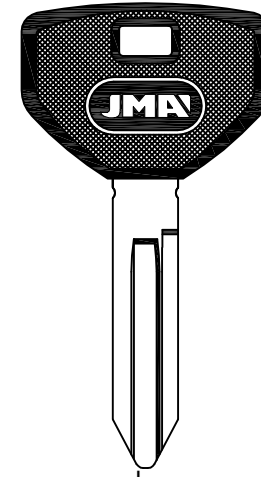

J...  
0001-3580  
**CHR-10.P**  
FOR: CHRYSLER®  
FOR: YALE®

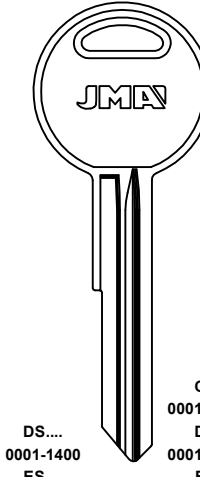

DS...  
0001-1400  
ES...  
0001-3000  
**CHR-12**

FOR: CHRYSLER®  
FOR: BRIGGS & STRATTON®

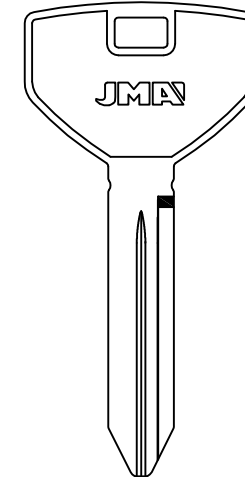

CV  
0001-1500  
DS  
0001-1500  
ES  
0001-1500

**CHR-13**

FOR: CHRYSLER®

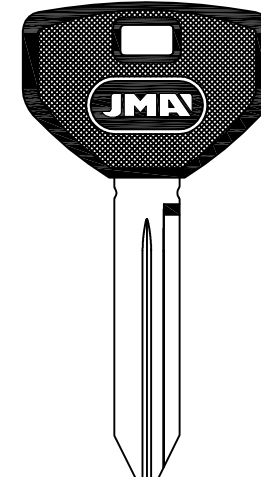

L... 1-3580  
**CHR-14.P**

FOR: CHRYSLER®

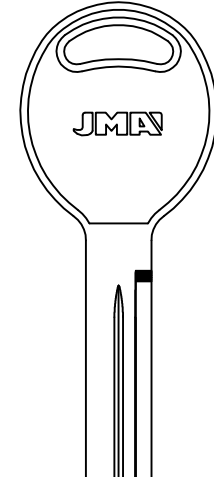

L... 1-3580  
**CHR-15**

FOR: CHRYSLER®

FOR: BRIGGS & STRATTON® -YALE® FOR: BRIGGS & STRATTON® -YALE® FOR: BRIGGS & STRATTON® -YALE®

FOR: CHRYSLER®

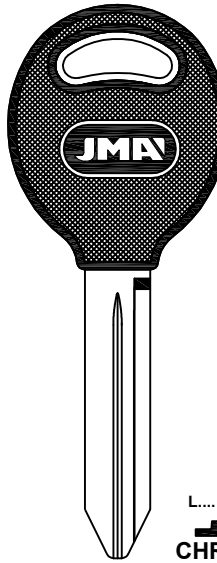

L... 1-3580  
**CHR-15.P**  
FOR: CHRYSLER®  
FOR: BRIGGS & STRATTON® -YALE®

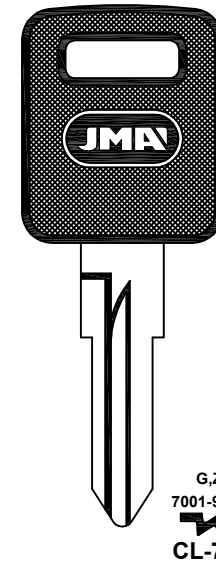

G,Z  
7001-9956  
**CL-7.P**

FOR: CLAUSSOR®  
FOR: GIOBERT®

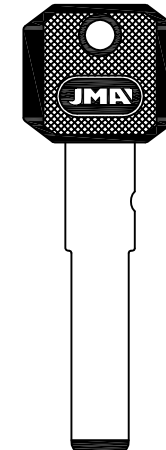

**FI-16.P1**

FOR: TRW-SIPEA®  
FOR: GIOBERT®

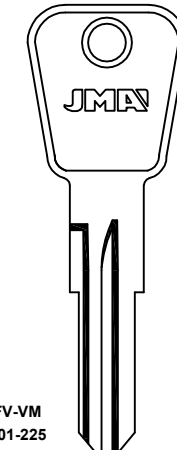

FV-VM  
101-225  
301-360  
VT...  
400-474  
**LF-6**

FOR: L. & F.®

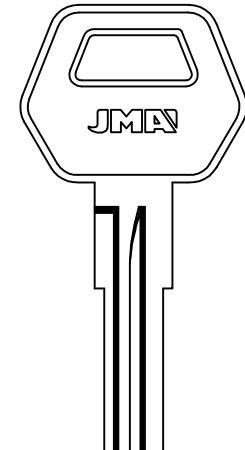

SL  
5001-7000  
**LF-SL**

FOR: L. & F.®  
FOR: ROOTES®

FOR: CHRYSLER®

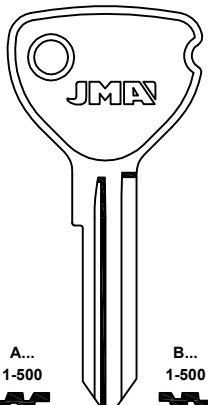

A...  
1-500  
**OP-HA**

B...  
1-500  
**OP-HB**



A...  
1-500  
**OP-NA**

B...  
1-500  
**OP-NB**

FOR: HUF®  
FOR: YMOS®

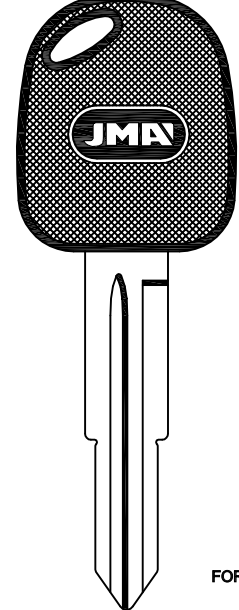

**DAE-3.P2**

FOR: DAEWOO®



J...  
1-1200  
**DAE-3D.P2**

FOR: DAEWOO®

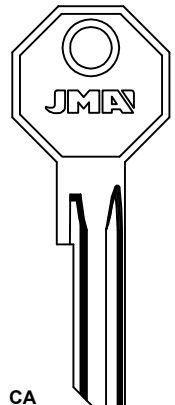

CA  
0001-1800  
**BAS-2I**



**BAS-2D**

D,C,P,D



**BAS-3**

FOR: BASCO®  
FOR: CORBIN® -YALE®

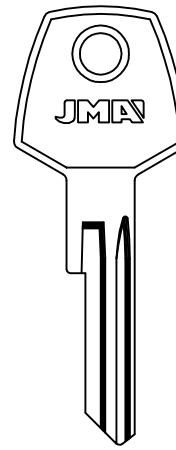

**CHR-1**

FOR: CHRYSLER®  
FOR: YALE®

FOR: CHRYSLER®

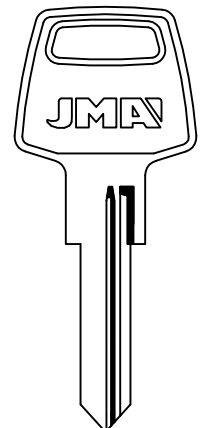

**CHR-2**

FOR: CHRYSLER®  
FOR: ROSS®

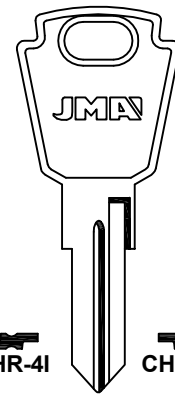

**CHR-4I**



**RO-1IS**

FOR: RONIS®

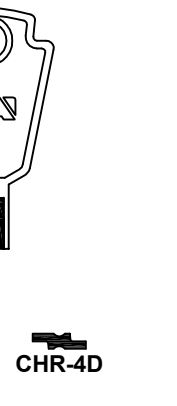

**CHR-4D**

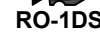

**RO-1DS**

**RO-3**

FOR: RONIS®

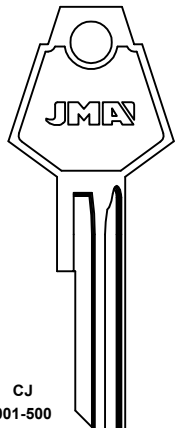

CJ  
001-500

DP  
0001-1400

EP  
0001-3000



**CHR-7**

FOR: CHRYSLER®

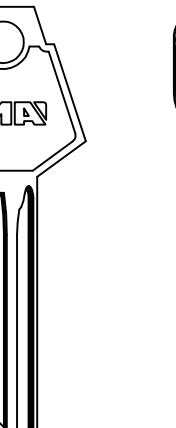

DP  
0001-1400

EP  
0001-3000



**CHR-8**

FOR: CHRYSLER®

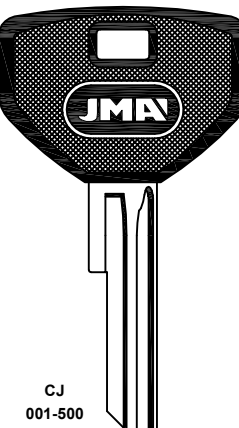

CJ  
001-500

DP  
0001-1400

EP  
0001-3000



**CHR-7.P**

FOR: CHRYSLER®



DP  
0001-1400

EP  
0001-3000



**CHR-8.P**

FOR: CHRYSLER®

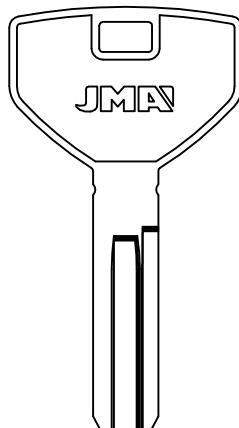

J...  
0001-3580



**CHR-10**

FOR: CHRYSLER®  
FOR: YALE®

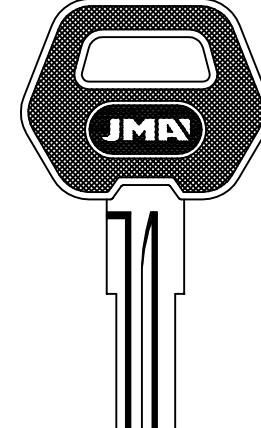

SL  
5001-7000  
**LF-SL.P**

FOR: L. & F.®  
FOR: ROOTES®

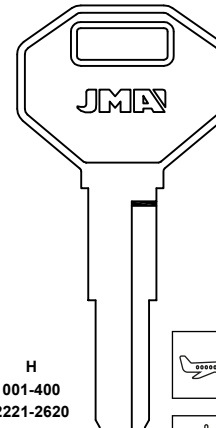

H  
001-400  
2221-2620  
4441-4640  
4641-5143

E  
2001-3000



**MIT-11**

FOR: MITSUBISHI®

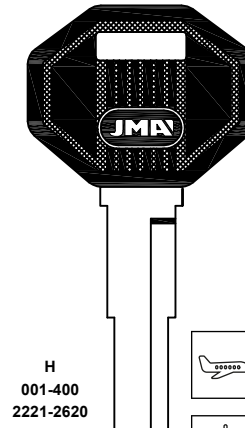

H  
001-400  
2221-2620  
4441-4640  
4641-5143

E  
2001-3000



**MIT-11.P**

FOR: MITSUBISHI®

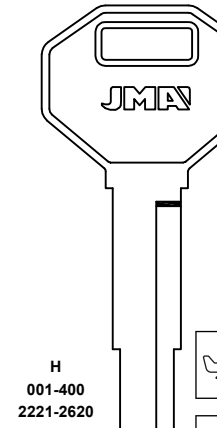

H  
001-400  
2221-2620  
4441-4640  
4641-5143

E  
2001-3000



**MIT-21**

FOR: MITSUBISHI®

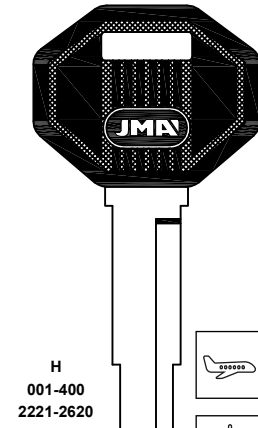

H  
001-400  
2221-2620  
4441-4640  
4641-5143

E  
2001-3000



**MIT-21.P**

FOR: MITSUBISHI®

Concerning the marks and commercial denominations see legal warning.  
Concerniente a las marcas y denominaciones comerciales ver aviso legal.  
Marka eta izendapen komertzialiei dagokienez, ikus lege-oharra.  
Concernant les marques et dénominations commerciales voir la note dans l'index.

FOR: CHRYSLER®

FOR: CITROEN®

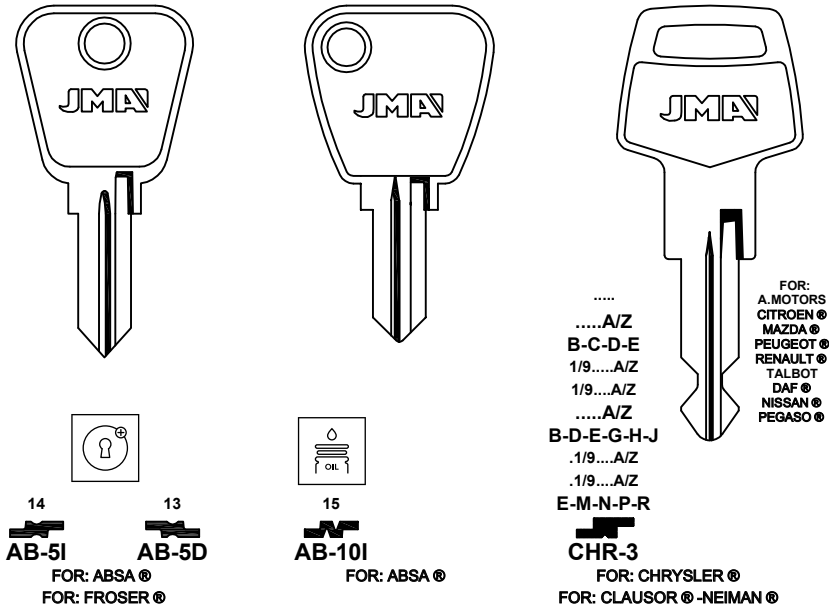
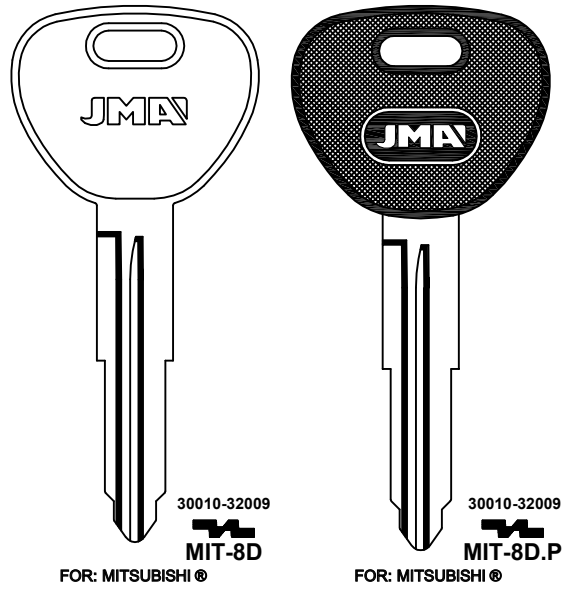

FOR: CITROEN®

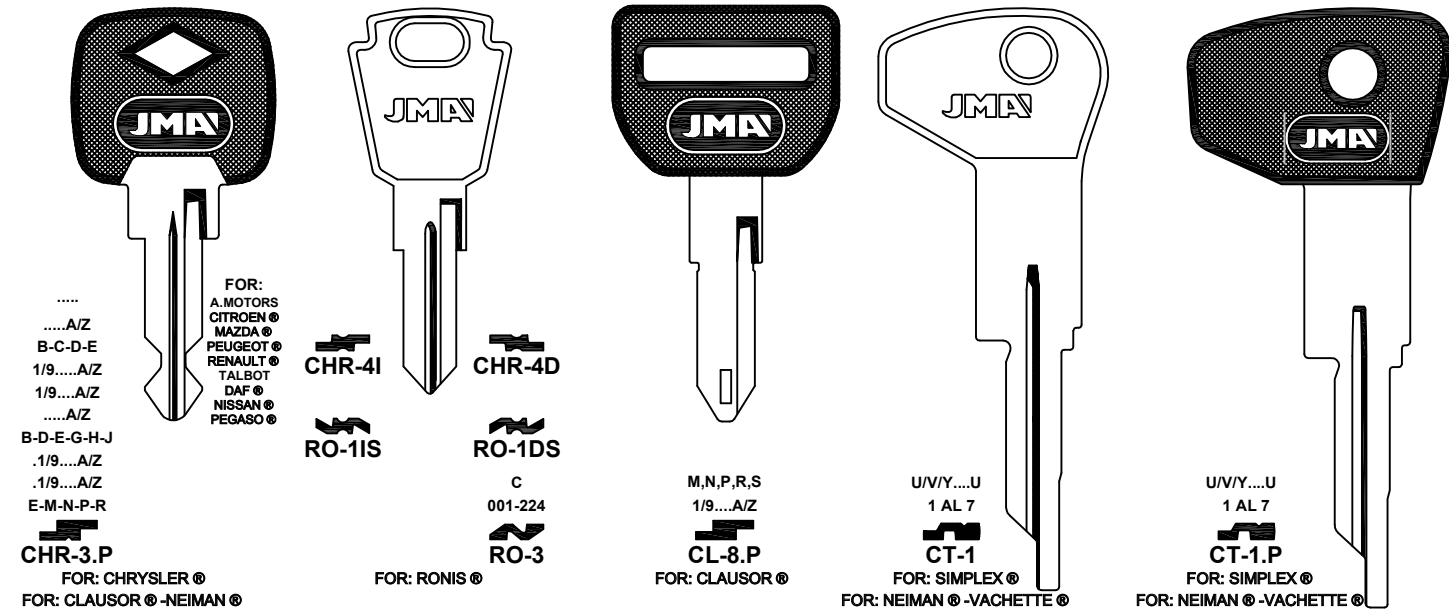

FOR: CITROEN®

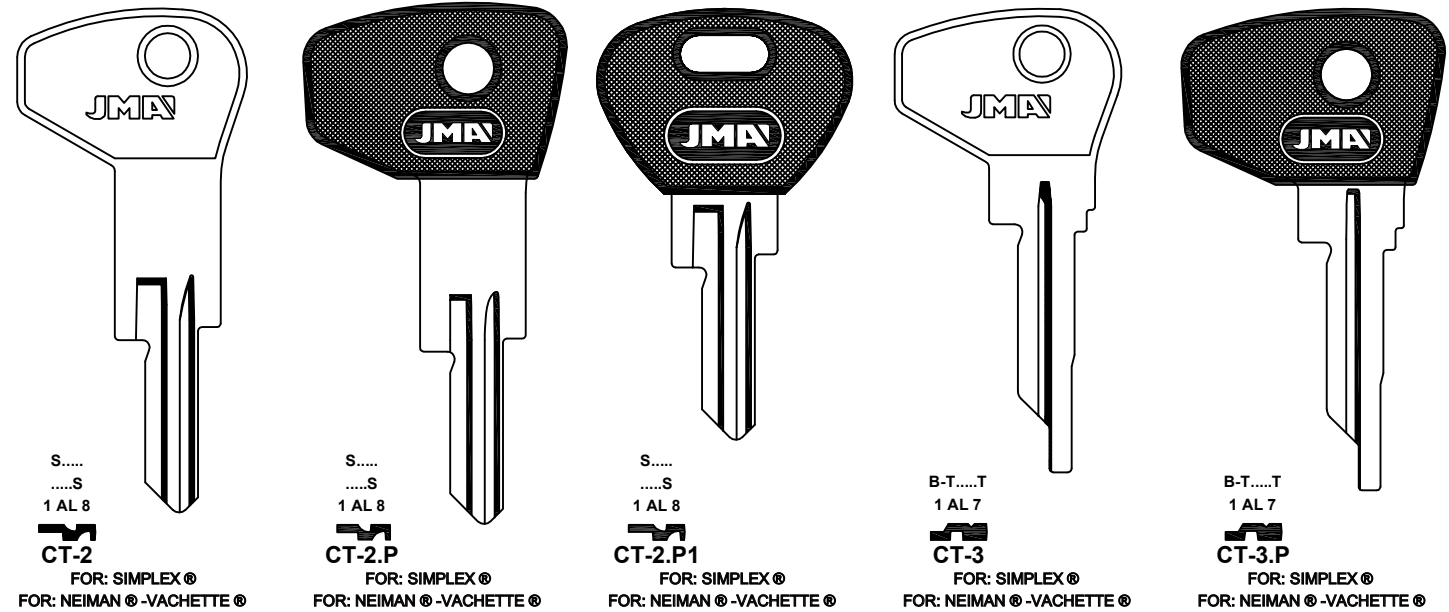

FOR: CITROEN®

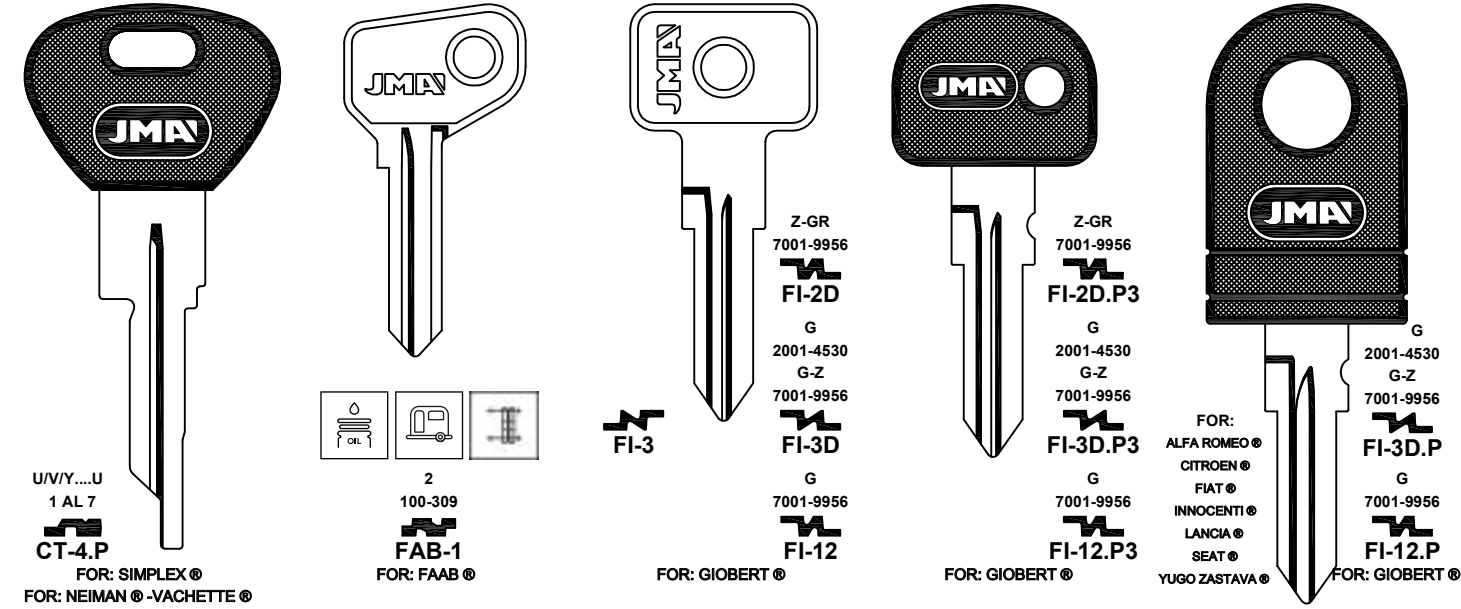

FOR: CITROEN®

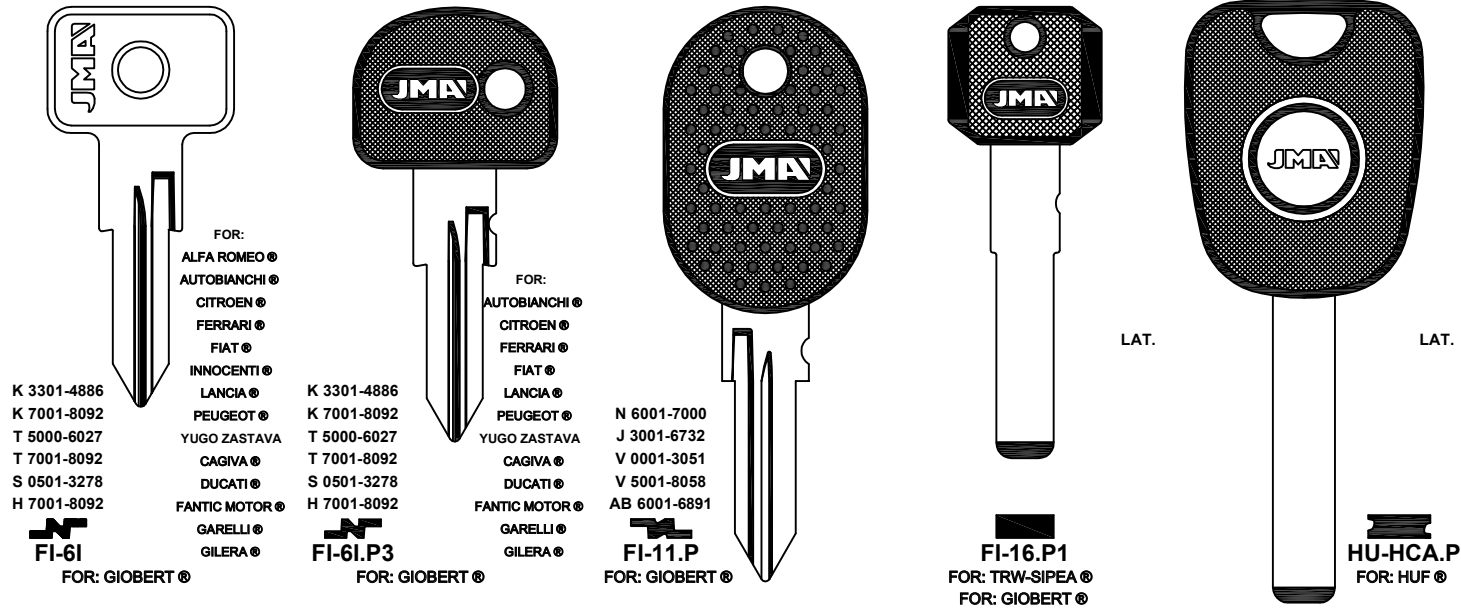

FOR: CITROEN®

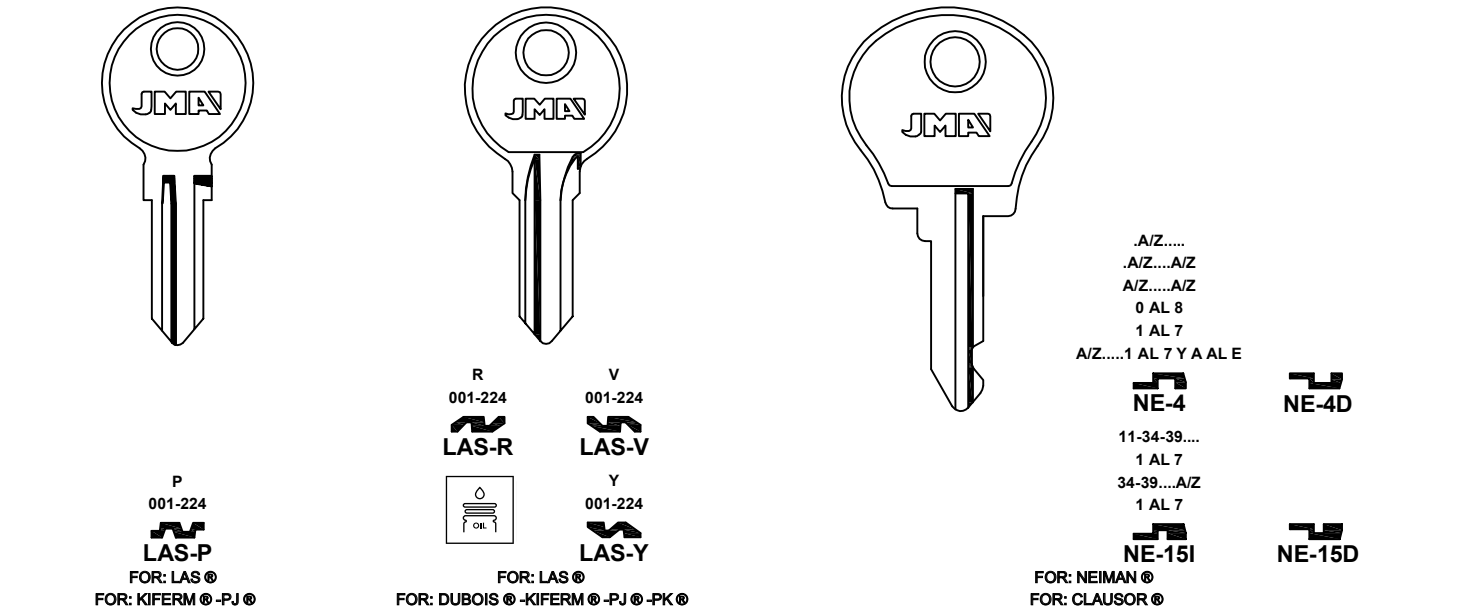

Concerning the marks and commercial denominations see legal warning.  
Concerniente a las marcas y denominaciones comerciales ver aviso legal.  
Marka eta izendapen komertzialiei dagokienez, ikus lege-oharra.  
Concernant les marques et denominations commerciales voir la note dans l'index.

**JMA** Opening the future

**JMA** Opening the future

Beziehen auf die marke und handelsname sehen sie die notiz im Impressum.  
Relativamente às marcas e denominações comerciais, ver aviso legal.  
Jeśli chodzi o znaki i nazwy handlowe, patrz Informacje prawne.

FOR: CITROEN ®

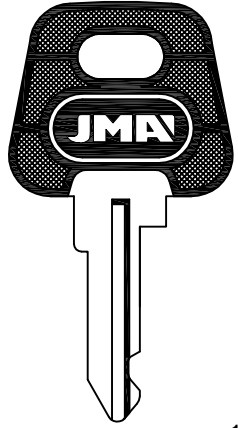

.A/Z.....  
A/Z...A/Z  
A/Z...A/Z  
0 AL 8  
1 AL 7  
A/Z...1 AL 7 Y A A L E



11-34-39...  
1 AL 7  
34-39...A/Z  
1 AL 7  
**NE-15I.P**  
FOR: NEIMAN ®  
FOR: CLAUSOR ®

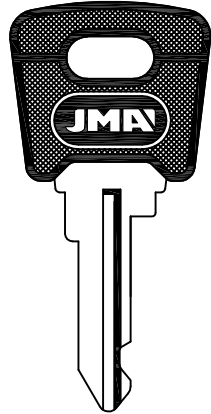

.A/Z.....  
A/Z...A/Z  
A/Z...A/Z  
0 AL 8  
1 AL 7  
A/Z...1 AL 7 Y A A L E



11-34-39...  
1 AL 7  
34-39...A/Z  
1 AL 7  
**NE-15I.P1**  
FOR: NEIMAN ®  
FOR: CLAUSOR ®

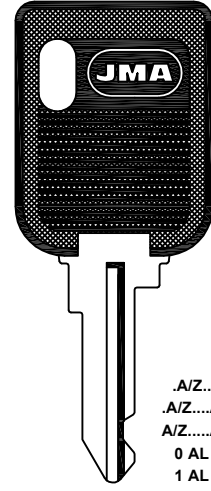

.A/Z.....  
A/Z...A/Z  
A/Z...A/Z  
0 AL 8  
1 AL 7  
A/Z...1 AL 7 Y A A L E

**NE-4.P2**  
FOR: NEIMAN ®  
FOR: CLAUSOR ®

FOR: CITROEN ®

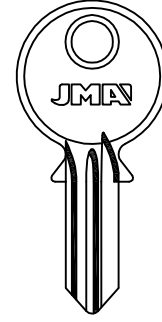

.4AB-ZZ  
S...331-348  
**RO-2I**

A8..AA-DS  
..8AB-ZZ  
S...385-402  
**RO-1I**

FOR: ABSA ® -FROSER ® -PJ ® -SADV ®

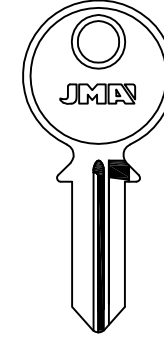

.3AB-ZZ  
...1 AL 4  
**RO-2D**

AA-JZ  
A4../A.4.  
**RO-4I**

AB-ZZ  
..6  
S...349-366  
**RO-6I**



C4..AA-ZY  
D4..AA-HR  
**RO-5I**

FOR: RONIS ®  
FOR: ABSA ®

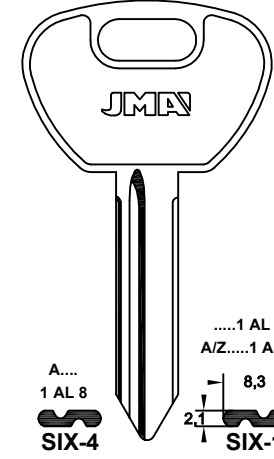

.....1 AL 8  
A/Z...1 AL 8  
8,3  
**SIX-1**

A....  
1 AL 8  
**SIX-4**

.....1 AL 8  
A/Z...1 AL 8  
**SIX-2**

FOR: SIMPLEX ®  
FOR: NEIMAN ®

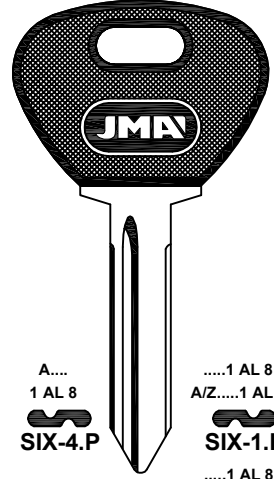

.....1 AL 8  
A/Z...1 AL 8  
**SIX-1.P**

.....1 AL 8  
A/Z...1 AL 8  
**SIX-2.P**

FOR: SIMPLEX ®  
FOR: NEIMAN ®

FOR: CITROEN ®

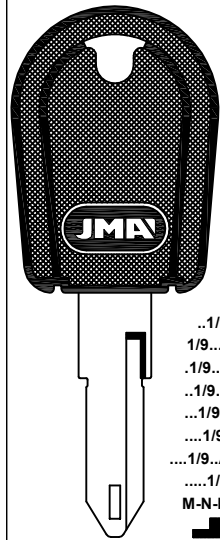

..1/9....  
1/9...A/Z  
.1/9...A/Z  
..1/9...A/Z  
..1/9...A/Z  
..1/9...A/Z  
.....1/9...A/Z  
.....1/9...A/Z  
.....1/9...A/Z  
.....1/9...A/Z  
M-N-P-R-S

**NE-20.P3**  
FOR: NEIMAN ®

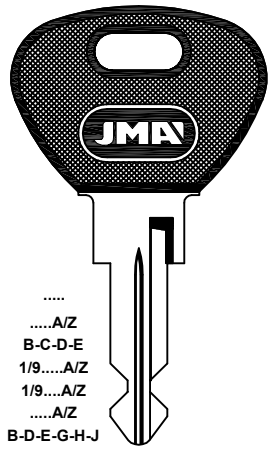

.....  
.....A/Z  
B-C-D-E  
1/9...A/Z  
1/9...A/Z  
..1/9...A/Z  
.....A/Z  
B-D-E-G-H-J  
1/9...A/Z  
.....1/9...A/Z  
.....1/9...A/Z  
.....1/9...A/Z  
E-M-N-P-R

**NE-22.P1**  
FOR: NEIMAN ®  
FOR: CLAUSOR ®

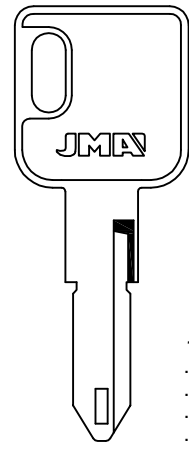

..1/9....  
1/9...A/Z  
.1/9...A/Z  
..1/9...A/Z  
..1/9...A/Z  
.....1/9...A/Z  
.....1/9...A/Z  
.....1/9...A/Z  
.....1/9...A/Z  
M-N-P-R-S

**NE-36**  
FOR: NEIMAN ®



VERDE O  
NEGRO  
..1/9....  
1/9...A/Z  
.1/9...A/Z  
..1/9...A/Z  
..1/9...A/Z  
.....1/9...A/Z  
.....1/9...A/Z  
.....1/9...A/Z  
.....1/9...A/Z  
M-N-P-R-S

**NE-36.P**  
FOR: NEIMAN ®

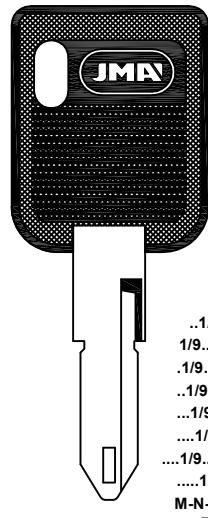

..1/9....  
1/9...A/Z  
.1/9...A/Z  
..1/9...A/Z  
..1/9...A/Z  
.....1/9...A/Z  
.....1/9...A/Z  
.....1/9...A/Z  
.....1/9...A/Z  
M-N-P-R-S

**NE-36.P1**  
FOR: NEIMAN ®

FOR: CITROEN ®

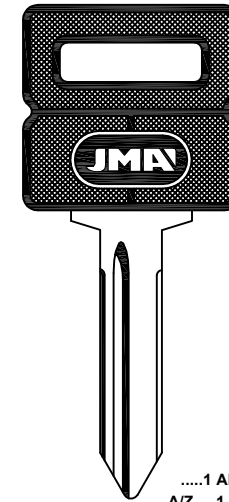

.....1 AL 8  
A/Z...1 AL 8  
**SIX-1.P1**

FOR: SIMPLEX ®  
FOR: NEIMAN ®

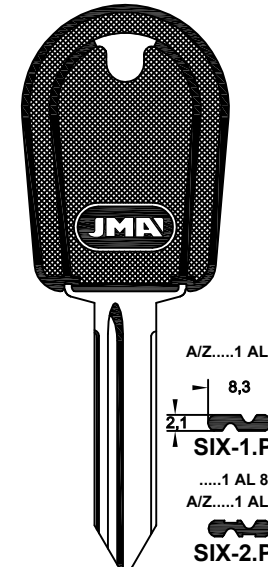

A/Z...1 AL 8  
8,3  
2,1  
**SIX-1.P2**  
.....1 AL 8  
A/Z...1 AL 8  
**SIX-2.P2**

FOR: SIMPLEX ®  
FOR: NEIMAN ®

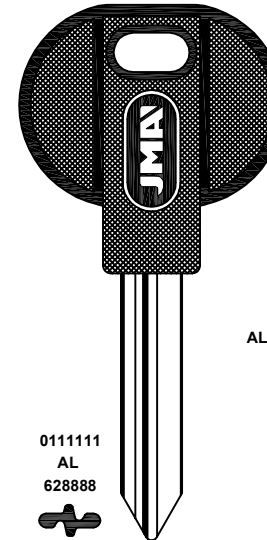

0111111  
AL  
628888  
**SIX-3.P**

FOR: SIMPLEX ®  
FOR: CITROEN ®

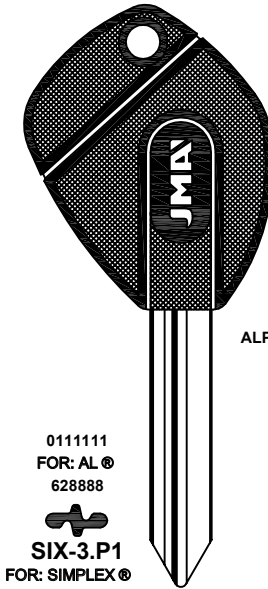

0111111  
FOR: AL ®  
628888  
**SIX-3.P1**

FOR: SIMPLEX ®

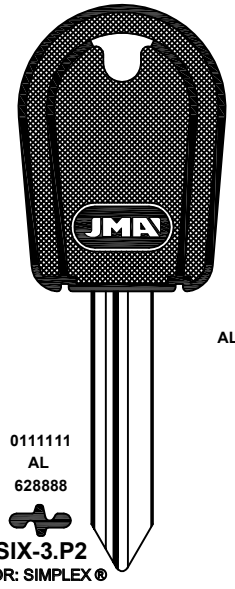

0111111  
AL  
628888  
**SIX-3.P2**

FOR: SIMPLEX ®

FOR: CITROEN ®

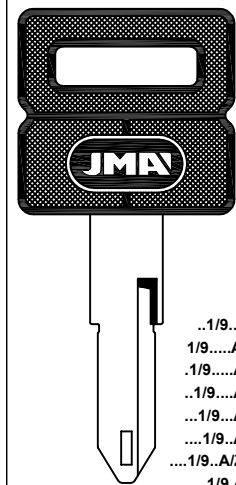

..1/9....  
1/9...A/Z  
.1/9...A/Z  
..1/9...A/Z  
..1/9...A/Z  
.....1/9...A/Z  
.....1/9...A/Z  
.....1/9...A/Z  
.....1/9...A/Z  
M-N-P-R-S

**NE-39.P**  
FOR: NEIMAN ®

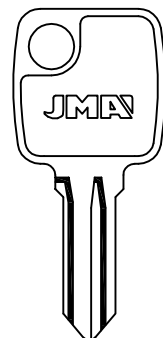

J...  
001-224  
**PJ-2**  
FOR: PJ ®  
FOR: KIFERM ®

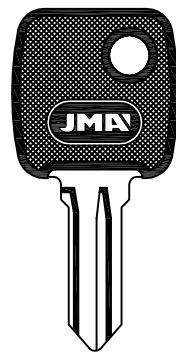

J...  
001-224  
**PJ-2.P**  
FOR: PJ ®  
FOR: KIFERM ®

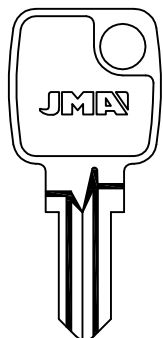

K...4-6-8  
K...4-6-8-A-B-C  
**PJ-K**  
FOR: PJ ®

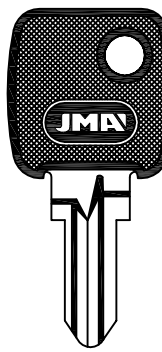

K...4-6-8  
K...4-6-8-A-B-C  
**PJ-K.P**  
FOR: PJ ®

FOR: CITROEN ®

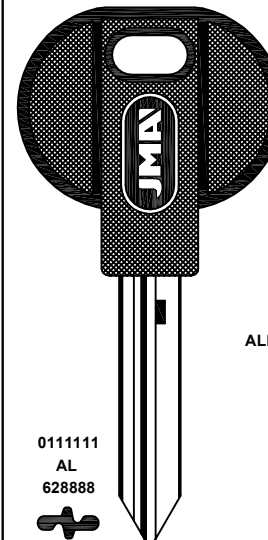

0111111  
AL  
628888  
**SIX-5.P**

FOR: SIMPLEX ®

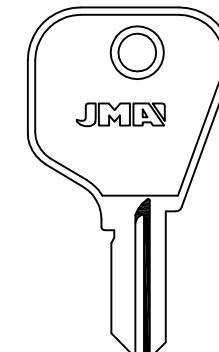

E...  
001-649  
**VA-6**  
FOR: VACHETTE ®  
FOR: SIMPLEX ®

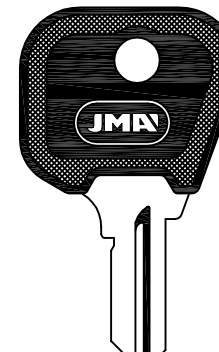

E...  
001-649  
**VA-6.P**  
FOR: VACHETTE ®  
FOR: SIMPLEX ®

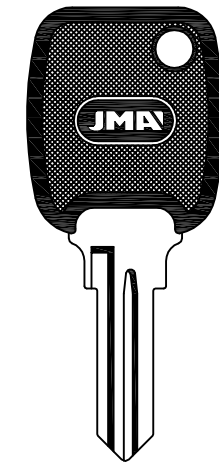

**DAC-1D.P**  
FOR: DACIA ®

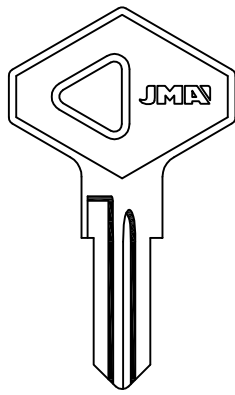

**DAC-2D**  
FOR: DACIA ®

Concerning the marks and commercial denominations see legal warning.  
Concerniente a las marcas y denominaciones comerciales ver aviso legal.  
Marka eta izendapen komertzialiei dagokienez, ikus lege-oharra.  
Concernant les marques et denominations commerciales voir la note dans l'index.



FOR: DACIA®

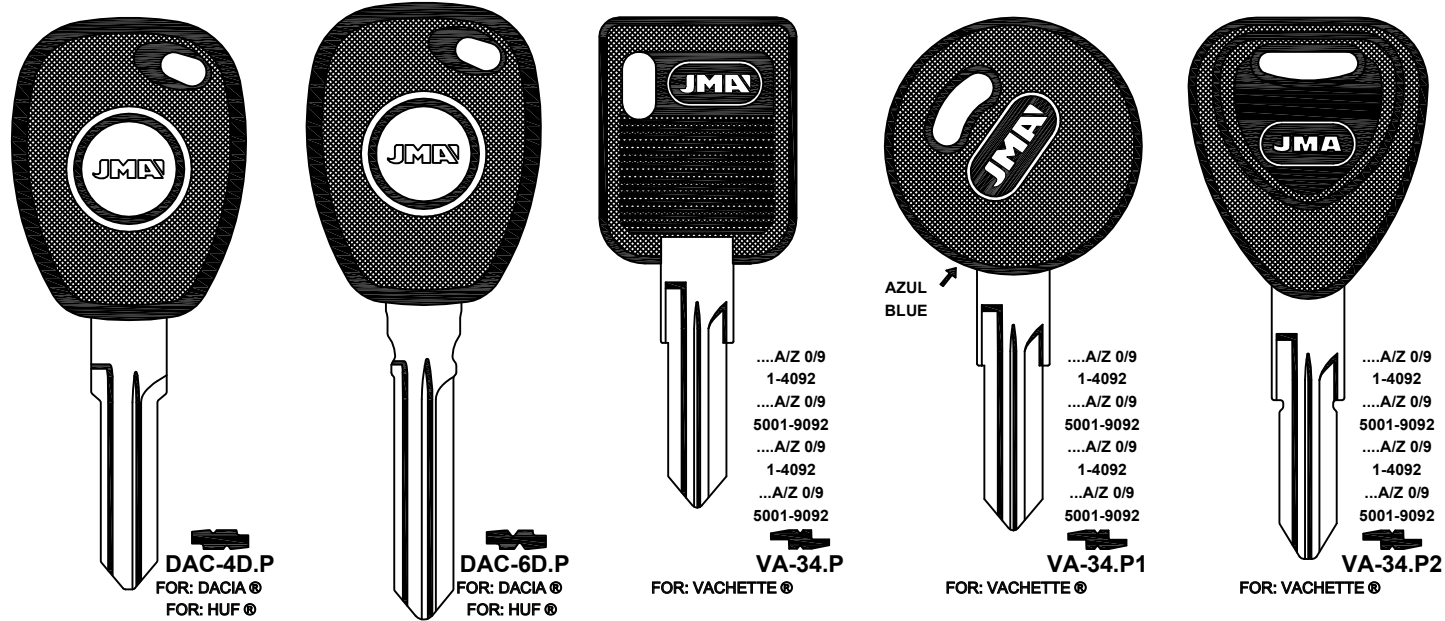

FOR: DAEWOO®

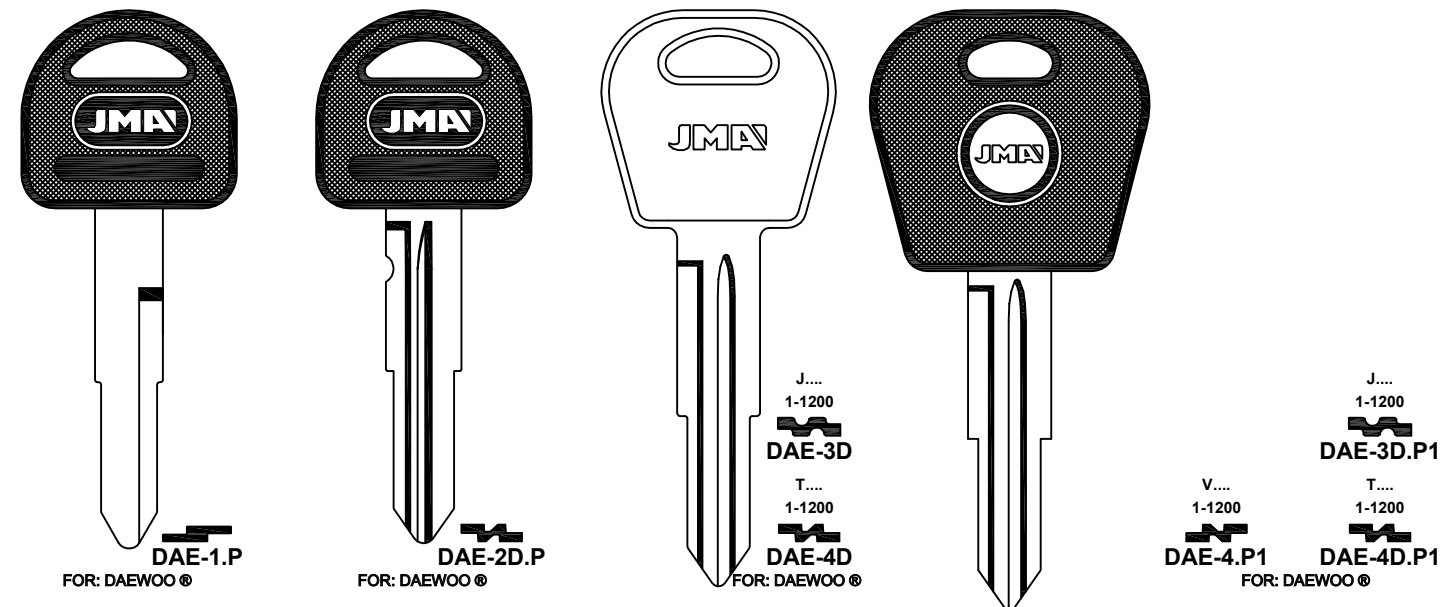

FOR: DAEWOO®

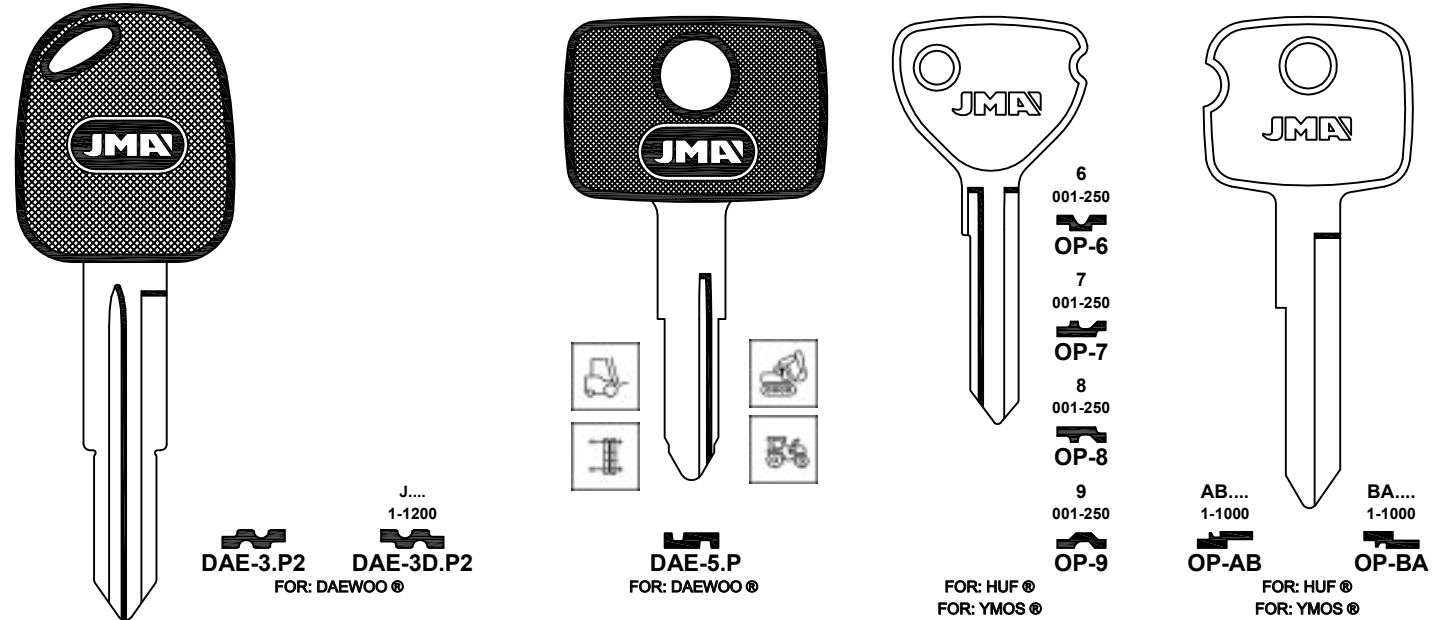

FOR: DAEWOO®

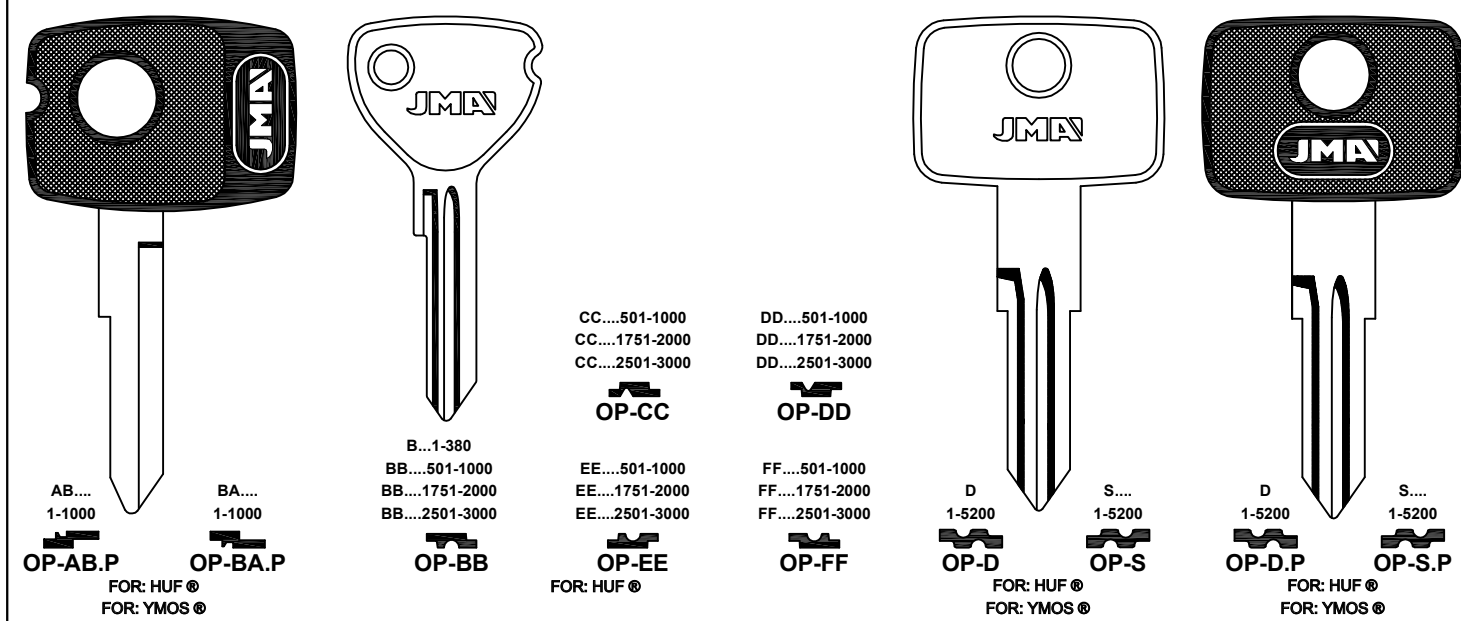

FOR: DAEWOO®

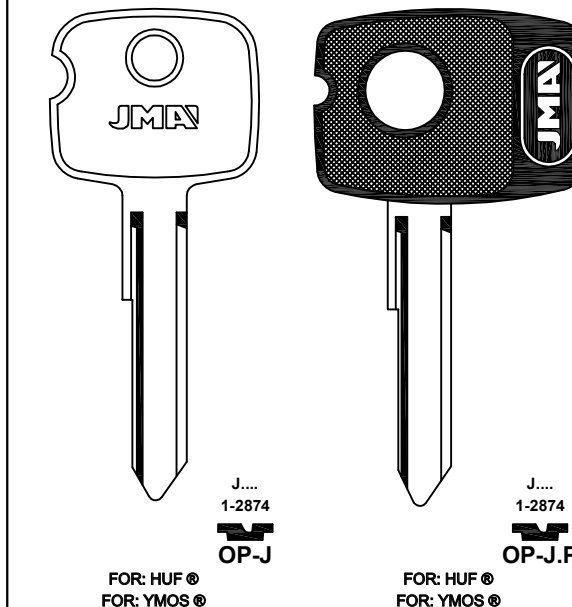

FOR: DAEWOO (USA)®

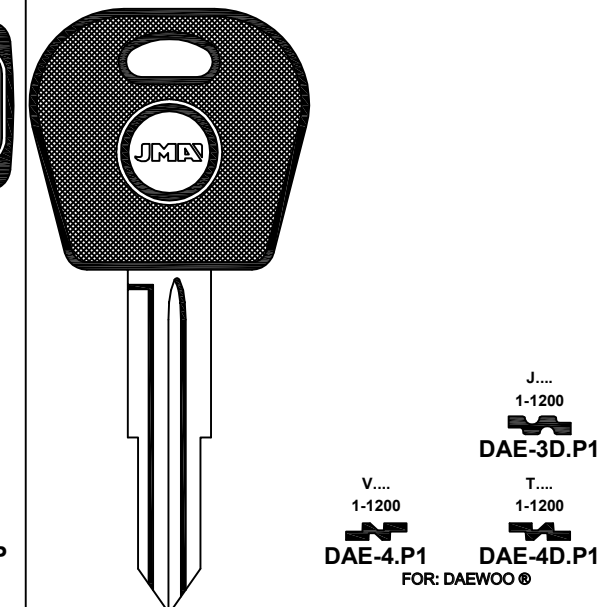

FOR: DAF®

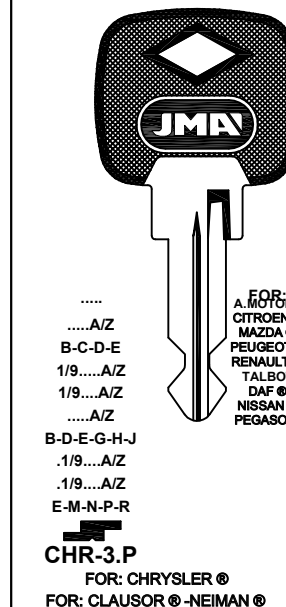

FOR: DAF®

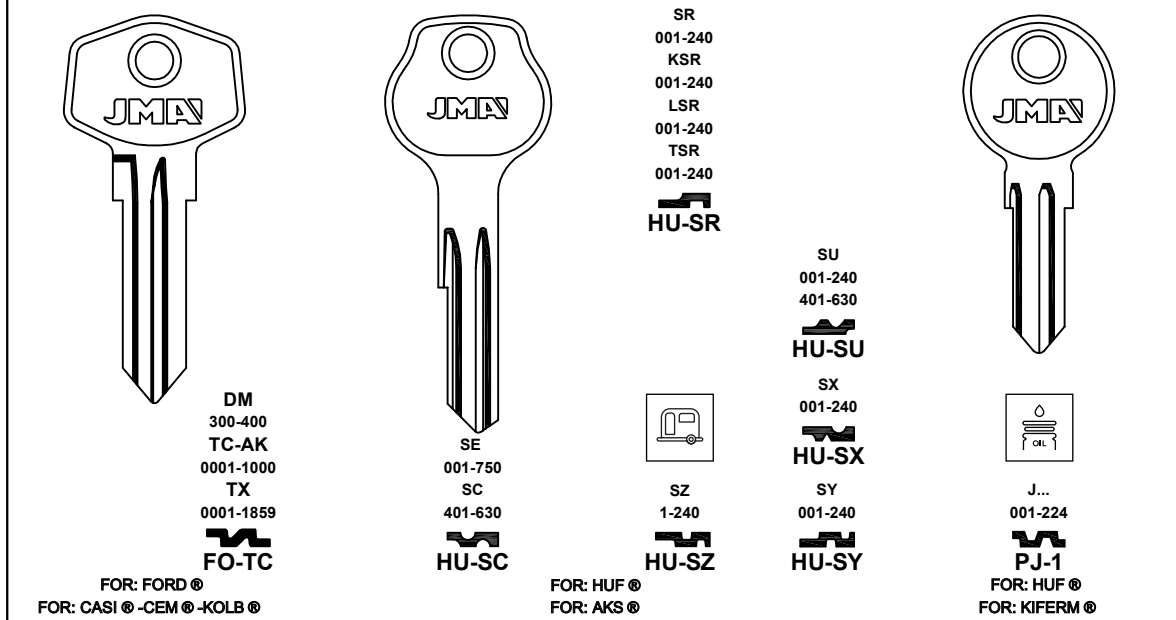

FOR: DAIHATSU®

Concerning the marks and commercial denominations see legal warning.  
 Concerniente a las marcas y denominaciones comerciales ver aviso legal.  
 Marka eta izendapen komertzialiei dagokienez, ikus lege-oharra.  
 Concernant les marques et denominations commerciales voir la note dans l'index.

**JMA** Opening the future

**JMA** Opening the future

Beziehen auf die Marke und Handelsname sehen sie die Notiz im Impressum.  
 Relativamente às marcas e denominações comerciais, ver aviso legal.  
 Jeśli chodzi o znaki i nazwy handlowe, patrz Informacje prawne.



FOR: DAIHATSU®

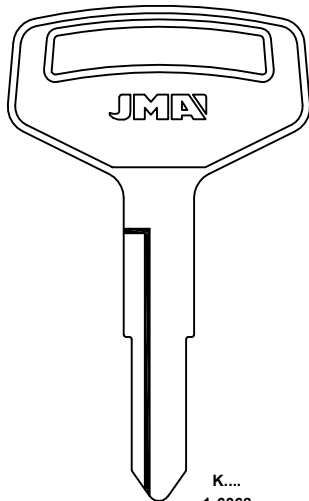

K....  
1-6368  
**DAI-2D**  
FOR: DAIHATSU®

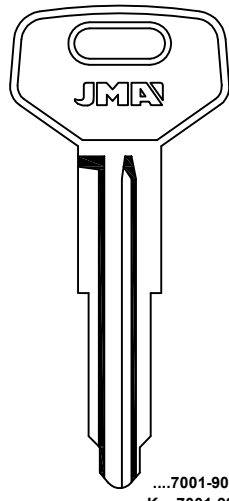

....7001-9000  
K....7001-9000  
**TOYO-3**  
FOR: TOYOTA®  
FOR: TOKAJ®-RIKA®

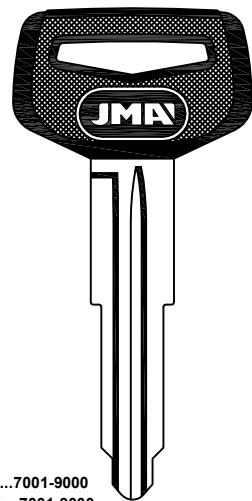

....7001-9000  
K....7001-9000  
**TOYO-3.P**  
FOR: TOYOTA®  
FOR: TOKAJ®-RIKA®

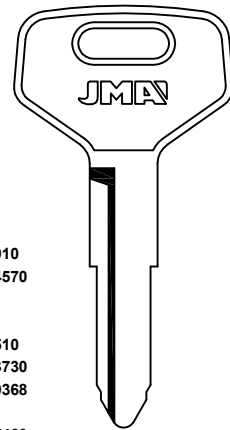

K....  
001-400/1511-1910  
2221-2620/3731-4570  
5001-6368  
R....  
401-800/1112-1510  
2621-3020/3331-3730  
5001-6924/8001-9368  
S....  
5951-6350/7061-7460  
8171-8570/9281-9680  
D....  
6001-7042  
**TOYO-K1**

FOR: TOYOTA®  
FOR: TOKAJ®-RIKA®

F....  
5951-6350  
7061-7460  
8171-8570  
9281-9680  
P....  
7001-8500  
**TOYO-4**  
C....  
6001-7042  
**TOYO-14**

FOR: DE LOREAN®

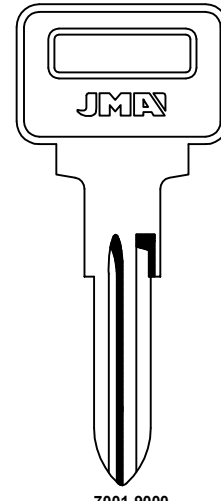

....7001-9000  
**NE-10**  
FOR: NEIMAN®

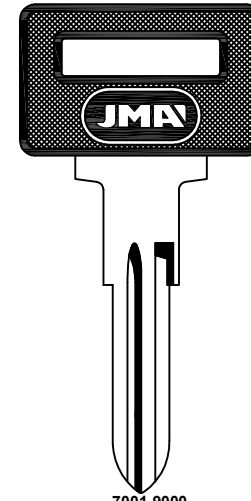

....7001-9000  
**NE-10.P**  
FOR: NEIMAN®

FOR: DELTA MOTOR®

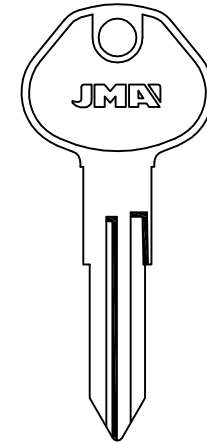

X  
0001-8000  
**DAT-6**  
Y  
0001-8000  
8001-9000  
**DAT-7**  
FOR: NISSAN®  
FOR: DATSUN®

**DAT-6D**

FOR: DAIHATSU®

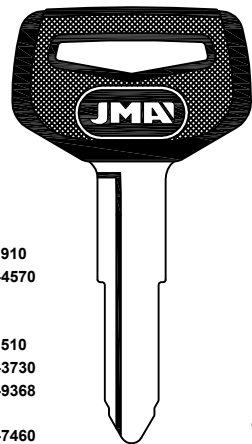

K....  
001-400/1511-1910  
2221-2620/3731-4570  
5001-6368  
R....  
401-800/1112-1510  
2621-3020/3331-3730  
5001-6924/8001-9368  
S....  
5951-6350/7061-7460  
8171-8570/9281-9680  
D....  
6001-7042  
**TOYO-K1.P**

FOR: TOYOTA®  
FOR: TOKAJ®-RIKA®

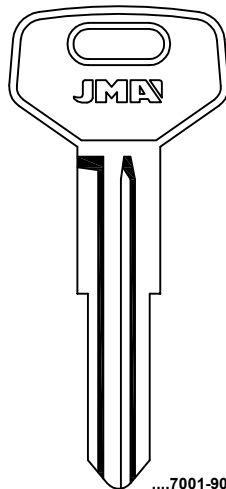

....7001-9000  
K....7001-9000  
**TOYO-8**

FOR: TOYOTA®  
FOR: TOKAJ®-RIKA®

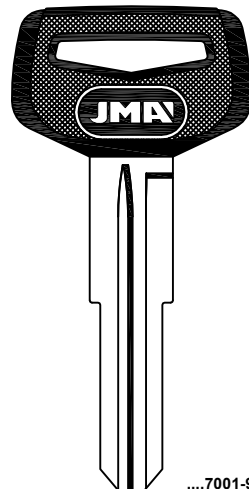

....7001-9000  
K....7001-9000  
**TOYO-8I.P**  
**TOYO-8.P**

FOR: TOYOTA®  
FOR: TOKAJ®-RIKA®

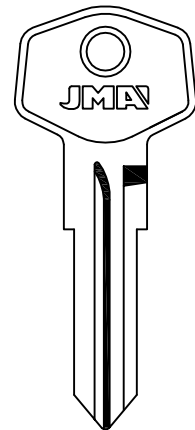

JC  
001-852  
**CEM-JC**  
AK  
0001-1000  
**FO-5**  
FOR: CEM®

FOR: DAIMLER®

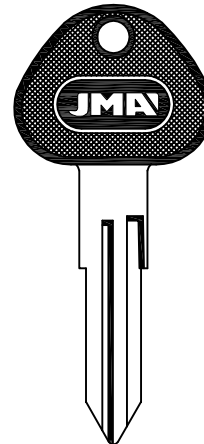

X  
0001-8000  
**DAT-6.P**

**DAT-6D.P**

Y  
0001-8000  
8001-9000  
**DAT-7.P**  
FOR: NISSAN®  
FOR: DATSUN®

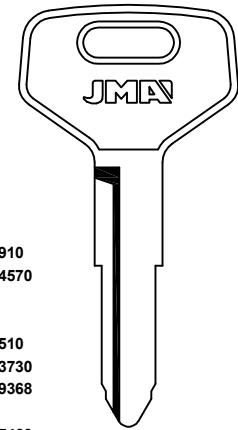

K....  
001-400/1511-1910  
2221-2620/3731-4570  
5001-6368  
R....  
401-800/1112-1510  
2621-3020/3331-3730  
5001-6924/8001-9368  
S....  
5951-6350/7061-7460  
8171-8570/9281-9680  
D....  
6001-7042  
**TOYO-K1**

FOR: TOYOTA®  
FOR: TOKAJ®-RIKA®

F....  
5951-6350  
7061-7460  
8171-8570  
9281-9680  
P....  
7001-8500  
**TOYO-4**  
C....  
6001-7042  
**TOYO-14**

FOR: DAIMLER®

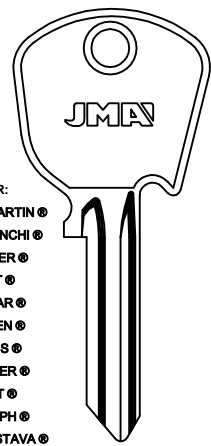

FOR:  
ASTON MARTIN®  
AUTOBIANCHI®  
DAIMLER®  
FIAT®  
JAGUAR®  
JENSEN®  
LOTUS®  
PREMIER®  
SEAT®  
TRIUMPH®  
YUGO ZASTAVA®  
SCANIA®  
FK  
1-3040  
4001-6000  
**FO-FK**  
**FO-FR**  
FOR: FORD®

FOR: ARMAN®-DOM®-JUGODENT®-WASO®

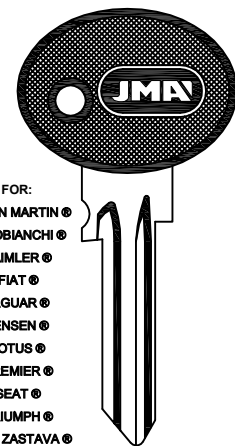

FOR:  
ASTON MARTIN®  
AUTOBIANCHI®  
DAIMLER®  
FIAT®  
JAGUAR®  
JENSEN®  
LOTUS®  
PREMIER®  
SEAT®  
TRIUMPH®  
YUGO ZASTAVA®  
SCANIA®  
FK  
1-3040  
4001-6000  
**FO-FK.P**  
**FO-FR.P**  
FOR: FORD®

FOR: ARMAN®-DOM®-JUGODENT®-WASO®

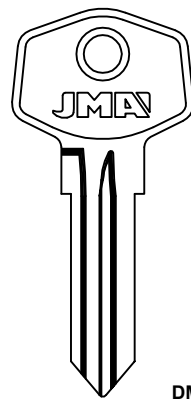

DM  
300-400  
TC-AK  
0001-1000  
TX  
0001-1859  
**FO-TC**  
FOR: FORD®

FOR: CASI®-CEM®-KOLB®

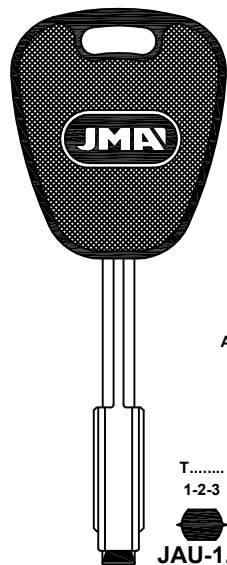

ALP.

T.....  
1-2-3  
**JAU-1.P**  
FOR: TIBBE®

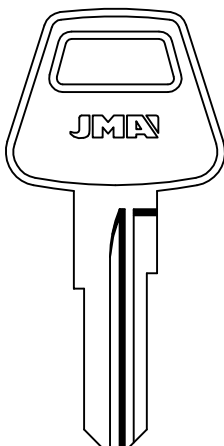

WR  
3000-3999  
5000-5999  
**LF-WR**  
FOR: L & F®

FOR: WILMOT BREEDEN®

FOR: DE LOREAN®



K....  
001-400/1511-1910  
2221-2620/3731-4570  
5001-6368  
R....  
401-800/1112-1510  
2621-3020/3331-3730  
5001-6924/8001-9368  
S....  
5951-6350/7061-7460  
8171-8570/9281-9680  
D....  
6001-7042  
**TOYO-K1.P**

FOR: TOYOTA®  
FOR: TOKAJ®-RIKA®

F....  
5951-6350  
7061-7460  
8171-8570  
9281-9680  
P....  
7001-8500  
**TOYO-4.P**  
C....  
6001-7042  
**TOYO-14.P**

FOR: DELTA MOTOR®

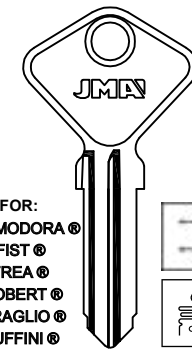

FOR:  
CROMODORA®  
FIST®  
FREA®  
GIOBERT®  
MIRAGLIO®  
RUFFINI®

6  
100-309  
**AF-5I**  
2  
100-309  
**AF-6I**

FOR: SAFE®

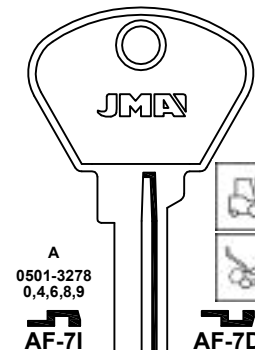

A  
0501-3278  
0,4,6,8,9  
**AF-7I**

H  
01-78  
**AF-8I**  
F  
01-78  
**AF-9I**

FOR: SIPEA®  
FOR: SAFE®

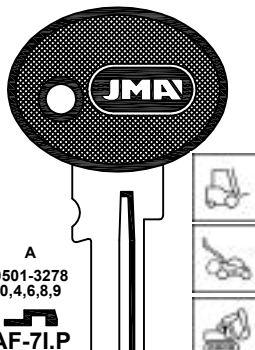

A  
0501-3278  
0,4,6,8,9  
**AF-7I.P**

H  
01-78  
**AF-8I.P**  
F  
01-78  
**AF-9I.P**

FOR: SIPEA®  
FOR: SAFE®

FOR: DISALCAR®

Concerning the marks and commercial denominations see legal warning.  
Concerniente a las marcas y denominaciones comerciales ver aviso legal.  
Marka eta izendapen komertzialiei dagokienez, ikus lege-oharra.  
Concernant les marques et denominations commerciales voir la note dans l'index.

**JMA** Opening the future

**JMA** Opening the future

Beziehen auf die marke und handelsname sehen sie die notiz im Impressum.  
Relativamente às marcas e denominações comerciais, ver aviso legal.  
Jeśli chodzi o znaki i nazwy handlowe, patrz Informacje prawne.

FOR: DISALCAR®

0501-1000  
IMS-3  
0501-1000  
IMS-5  
IMS-13

0501-1000  
AF-21  
0501-1000  
AF-19  
IMS-13.P

0501-1000  
IMS-3.P  
0501-1000  
IMS-5.P  
IMS-13.P

0501-1000  
AF-21.P  
0501-1000  
AF-19.P  
IMS-13.P

7.1  
1.95  
BH-4

FOR: BOSCH®  
FOR: KOLB®-POLAR®

FOR: SAFE®  
FOR: CROMODORA®-FIST®-JMSA®

FOR: SAFE®  
FOR: CROMODORA®-FIST®-JMSA®

FOR: DODGE®

CJ  
001-500  
DP  
0001-1400  
EP  
0001-3000  
CHR-7  
FOR: CHRYSLER®  
FOR: YALE®

DP  
0001-1400  
EP  
0001-3000  
CHR-8  
FOR: CHRYSLER®  
FOR: YALE®

CJ  
001-500  
DP  
0001-1400  
EP  
0001-3000  
CHR-7.P  
FOR: CHRYSLER®  
FOR: YALE®

DP  
0001-1400  
EP  
0001-3000  
CHR-8.P  
FOR: CHRYSLER®  
FOR: YALE®

FOR: DODGE®

30010-32009  
MIT-8D  
FOR: MITSUBISHI®

30010-32009  
MIT-8D.P  
FOR: MITSUBISHI®

E  
5001-7679  
MIT-12  
FOR: MITSUBISHI®

30010-32009  
MIT-13D  
FOR: MITSUBISHI®

30010-32009  
MIT-14D  
FOR: MITSUBISHI®

FOR: DODGE®

F... G....  
0000-1394  
CHR-9  
FOR: CHRYSLER®  
FOR: YALE®

F... G....  
0000-1394  
CHR-9.P  
FOR: CHRYSLER®  
FOR: YALE®

J....  
0001-3580  
CHR-10  
FOR: CHRYSLER®  
FOR: YALE®

J....  
0001-3580  
CHR-10.P  
FOR: CHRYSLER®  
FOR: YALE®

DS....  
0001-1400  
ES....  
0001-3000  
CHR-12  
FOR: CHRYSLER®  
FOR: BRIGGS & STRATTON®

CV  
0001-1500  
DS  
0001-1500  
ES  
0001-1500  
CHR-13D  
FOR: CHRYSLER®  
FOR: BRIGGS & STRATTON®

FOR: DODGE®

A/Z....  
...A/Z  
...A/Z 1/9  
2700-4816  
VA-10  
FOR: VACHETTE®

W...  
600-842  
WAS-1  
FOR: WASO®

FOR: EAGLE®

J....  
0001-3580  
CHR-10  
FOR: CHRYSLER®  
FOR: YALE®

J....  
0001-3580  
CHR-10.P  
FOR: CHRYSLER®  
FOR: YALE®

L.... 1-3580  
CHR-14  
FOR: CHRYSLER®  
FOR: BRIGGS & STRATTON®-YALE®

FOR: DODGE®

L.... 1-3580  
CHR-14  
FOR: CHRYSLER®  
FOR: BRIGGS & STRATTON®-YALE®

L.... 1-3580  
CHR-14.P  
FOR: CHRYSLER®  
FOR: BRIGGS & STRATTON®-YALE®

E....  
5001-7679  
CHR-17  
FOR: CHRYSLER®

E  
5001-7000  
MIT-7  
FOR: MITSUBISHI®  
FOR: CHRYSLER®-MITSUBISHI®

E  
5001-7000  
7001-7679  
MIT-15.P  
FOR: MITSUBISHI®  
FOR: CHRYSLER®-MITSUBISHI®

FOR: EAGLE®

L.... 1-3580  
CHR-14.P  
FOR: CHRYSLER®  
FOR: BRIGGS & STRATTON®-YALE®

E....  
5001-7679  
CHR-17  
FOR: CHRYSLER®

FV-VM  
101-225  
301-360  
VT...  
400-474  
LF-6  
FOR: L. & F.®

H  
001-400  
2221-2620  
4441-4640  
4641-5143  
E  
2001-3000  
MIT-11  
FOR: MITSUBISHI®

MIT-1D  
FOR: MITSUBISHI®

E  
5001-7000  
MIT-7  
FOR: MITSUBISHI®

Concerning the marks and commercial denominations see legal warning.  
Concerniente a las marcas y denominaciones comerciales ver aviso legal.  
Marka eta izendapen komertzialiei dagokienez, ikus lege-oharra.  
Concernant les marques et dénominations commerciales voir la note dans l'index.

**JMA** Opening the future

**JMA** Opening the future

Beziehen auf die marke und handelsname sehen sie die notiz im Impressum.  
Relativamente às marcas e denominações comerciais, ver aviso legal.  
Jeśli chodzi o znaki i nazwy handlowe, patrz Informacje prawne.

FOR: EAGLE®

**MIT-7.P**  
 E 5001-7000  
 FOR: MITSUBISHI®

**MIT-8D**  
 30010-32009  
 FOR: MITSUBISHI®

**MIT-8D.P**  
 30010-32009  
 FOR: MITSUBISHI®

**MIT-12**  
 E 5001-7679  
 FOR: MITSUBISHI®

**MIT-13D**  
 30010-32009  
 FOR: MITSUBISHI®

FOR: EAGLE®

**MIT-14D**  
 30010-32009  
 FOR: MITSUBISHI®

**NE-19**  
 .....1/9..A/Z  
 ..1/9....  
 1/9.....A/Z  
 .1/9.....A/Z  
 ..1/9....A/Z  
 ...1/9...A/Z  
 ....1/9..A/Z  
 .....1/9..A/Z A/Z  
 M-N-P-R-S  
 FOR: NEIMAN®

**NE-19.P**  
 .....1/9..A/Z  
 ..1/9....  
 1/9.....A/Z  
 .1/9.....A/Z  
 ..1/9....A/Z  
 ...1/9...A/Z  
 ....1/9..A/Z  
 .....1/9..A/Z A/Z  
 M-N-P-R-S  
 FOR: NEIMAN®

**NE-28**  
 ..1/9....A/Z  
 M-N-P-R-S  
 FOR: NEIMAN®

**VA-10**  
 A/Z.....  
 ....A/Z 1/9  
 2700-4816  
 FOR: VACHETTE®

FOR: EBRO®

**CL-2I** **CL-2D**  
 FOR: CLAUSOR®

**CL-3I**  
 FOR: CLAUSOR®

**DAT-6** **DAT-6D**  
 X 0001-8000  
 FOR: NISSAN®

**DAT-7**  
 Y 0001-8000  
 8001-9000  
 FOR: DATSUN®

FOR: EBRO®

**DAT-6.P** **DAT-6D.P**  
 X 0001-8000  
 FOR: NISSAN®

**DAT-7.P**  
 Y 0001-8000  
 8001-9000  
 FOR: DATSUN®

**DA-OA** **FO-OR**  
 001-210  
 ER-PN  
 101-295  
 ER  
 001-195  
 ER  
 501-695  
 FOR: FORD®

**FO-OL** **FO-OR**  
 OL 001-210  
 07R 001-195  
 7OR 001-210  
 001-210  
 FOR: FORD®

**FO-OL** **FO-OR**  
 OL 001-210  
 07L 001-195  
 7OL 001-210  
 OR 001-210  
 001-210  
 FOR: FORD®

**IMS-3** **AF-21**  
 0501-1000  
 FOR: CROMODORA®

**IMS-5** **AF-19**  
 0501-1000  
 FOR: CROMODORA®

**IMS-13** **AF-19**  
 0501-1000  
 FOR: CROMODORA®

FOR: EBRO®

**IMS-3.P** **AF-21.P**  
 0501-1000  
 FOR: CROMODORA®

**IMS-5.P** **AF-19.P**  
 0501-1000  
 FOR: CROMODORA®

**LMP-1** **LMP-1.P**  
 10055-12538  
 FOR: LMP®

**NE-3** **NE-3D** **NE-3.P**  
 .....A/Z  
 A/Z.....  
 A/Z.....A/Z  
 1 AL 7  
 .....A/Z  
 0 AL 9  
 FOR: NEIMAN®

**FOR: EBRO®**  
**FIAT®**  
**LADA VAZ®**  
**MOSKVITCH®**  
**PEUGEOT®**  
**RENAULT®**  
**TALBOT SIMCA®**  
**ZAZ®**  
**DAF®**  
**VOLVO®**

**FOR: EBRO®**  
**FIAT®**  
**LADA VAZ®**  
**MOSKVITCH®**  
**PEUGEOT®**  
**RENAULT®**  
**TALBOT SIMCA®**  
**ZAZ®**  
**DAF®**  
**VOLVO®**

FOR: EBRO®

**NE-3.P1** **NE-3.P2**  
 .....A/Z  
 A/Z.....  
 A/Z.....A/Z  
 1 AL 7  
 .....A/Z  
 0 AL 9  
 FOR: NEIMAN®

**PJ-2** **PJ-2.P**  
 J... 001-224  
 FOR: PJ®

**STS-2D** **STS-5D**  
 .....4001-6000  
 FR...  
 0001-3040  
 FOR: BLOCK®

Concerning the marks and commercial denominations see legal warning.  
 Concerniente a las marcas y denominaciones comerciales ver aviso legal.  
 Marka eta izendapen komertzialiei dagokienez, ikus lege-oharra.  
 Concernant les marques et dénominations commerciales voir la note dans l'index.



**FOR: EBRO®**

...4001-6000  
FR....  
0001-3040  
STS-2D.P  
FOR: STS®  
FOR: BLOCK®-DOM®

STS-5D.P  
FOR: EBRO®-NISSAN®  
FOR: DOM®

**FOR: FERRARI®**

FOR: CROMODORA®  
FIST®  
FREA®  
GIOBERT®  
MIRAGLIO®  
RUFFINI®

6 100-309 AF-5I  
8 100-309 AF-5D  
2 100-309 AF-6I  
4 100-309 AF-6D

A 0501-3278 0,4,6,8,9 AF-7I  
H O1-78 AF-8I  
F O1-78 AF-9I

A 0501-3278 0,4,6,8,9 AF-7D  
G O1-78 AF-8D  
E O1-78 AF-9D

A 0501-3278 0,4,6,8,9 AF-7I.P  
H O1-78 AF-8I.P  
F O1-78 AF-9I.P

G O1-78 AF-8D.P  
E O1-78 AF-9D.P

FOR: SAFE®  
FOR: SIPEA®  
FOR: SIPEA®  
FOR: SIPEA®  
FOR: SIPEA®  
FOR: SIPEA®  
FOR: SIPEA®  
FOR: SIPEA®

**FOR: FERRARI®**

.....A  
.....D  
.....F  
1 AL 5  
NE-25  
FOR: NEIMAN®

**FOR: FIAT®**

15-I 15-D  
FOR: SAFE®  
FOR: TRAMA®-FIST®

A 001-125 AF-1I  
B 001-125 AF-1D  
FOR: SAFE®  
FOR: SAFE®  
FOR: SIPEA®-MAGNETI MARELLI®

D 1-125 AF-2I  
C 1-125 AF-2D  
FOR: SAFE®  
FOR: SAFE®  
FOR: SIPEA®-MAGNETI MARELLI®

S 615-699 712-799 812-899 AF-4I  
D 115-199 212-299 312-399 AF-4D  
FOR: SAFE®  
FOR: SAFE®  
FOR: FIAT®-TRAMA®

**FOR: FERRARI®**

A 0501-3278 0,4,6,8,9 AF-7I.P1  
FOR: SIPEA®  
FOR: NEIMAN®

K-H 7001-8092 AF-14.P  
FOR: GIOBERT®  
FOR: FIST®-M.MARELLI®-NEIMAN®-SIPEA®

6 100-517 FAR-1I  
8 100-517 FAR-1D  
2 100-517 FAR-2I  
4 100-517 FAR-2D  
H 100-309 FAR-3  
FAR-3D  
FOR: FARMA®  
FOR: FISAM®

K 3301-4886 K 7001-8092 T 5000-6027 T 7001-8092 S 0501-3278 H 7001-8092  
FOR: FARMA®  
FOR: FISAM®

K 3301-4886 K 7001-8092 T 5000-6027 T 7001-8092 S 0501-3278 H 7001-8092  
FOR: GIOBERT®

FOR: ALFA ROMEO®  
AUTOBIANCHI®  
CITROEN®  
FERRARI®  
FIAT®  
INNOCENTI®  
LANCIA®  
PEUGEOT®  
YUGO ZASTAVA®  
CAGIVA®  
DUCATI®  
FANTIC MOTOR®  
GARELLI®  
GILERA®

K 3301-4886 K 7001-8092 T 5000-6027 T 7001-8092 S 0501-3278 H 7001-8092  
FOR: FERRARI®  
FIAT®  
INNOCENTI®  
LANCIA®

FOR: GIOBERT®  
FOR: GIOBERT®

**FOR: FIAT®**

FOR: CROMODORA®  
FIST®  
FREA®  
GIOBERT®  
MIRAGLIO®  
RUFFINI®

6 100-309 AF-5I  
8 100-309 AF-5D  
2 100-309 AF-6I  
4 100-309 AF-6D

A 0501-3278 0,4,6,8,9 AF-7I  
H O1-78 AF-8I  
F O1-78 AF-9I

A 0501-3278 0,4,6,8,9 AF-7D  
G O1-78 AF-8D  
E O1-78 AF-9D

A 0501-3278 0,4,6,8,9 AF-7I.P  
H O1-78 AF-8I.P  
F O1-78 AF-9I.P

G O1-78 AF-8D.P  
E O1-78 AF-9D.P

FOR: SAFE®  
FOR: SIPEA®  
FOR: SIPEA®  
FOR: SIPEA®  
FOR: SIPEA®  
FOR: SIPEA®  
FOR: SIPEA®  
FOR: SIPEA®

A 0501-3278 0,4,6,8,9 AF-7I.P1  
FOR: SIPEA®  
FOR: NEIMAN®

K-H 7001-8092 AF-14.P  
FOR: GIOBERT®  
FOR: FIST®-M.MARELLI®-NEIMAN®-SIPEA®

K 3301-4886 K 7001-8092 T 5000-6027 T 7001-8092 S 0501-3278 H 7001-8092  
FOR: GIOBERT®

FOR: FIAT®-MARELLI®-NEIMAN®-SIPEA®

**FOR: FERRARI®**

K 3301-4886 K 7001-8092 T 5000-6027 T 7001-8092 S 0501-3278 H 7001-8092  
FOR: GIOBERT®

FERRARI®  
CAGIVA®  
FI-6I.P3  
FOR: GIOBERT®

FOR: AUTOBIANCHI®  
CITROEN®  
FERRARI®  
FIAT®  
LANCIA®  
PEUGEOT®  
YUGO ZASTAVA®  
CAGIVA®  
DUCATI®  
FANTIC MOTOR®  
GARELLI®  
GILERA®

HU-1  
FOR: HUF®  
FOR: NEIMAN®-WITTE®-YMOS®

3 0501-1000 IMS-3  
4 0501-1000 AF-21  
3 0501-1000 IMS-3.P  
4 0501-1000 AF-21.P

1 0501-1000 IMS-5  
2 0501-1000 AF-19  
1 0501-1000 IMS-5.P  
2 0501-1000 AF-19.P

3 0501-1000 IMS-13  
4 0501-1000 IMS-13.P

FOR: SAFE®  
FOR: SAFE®  
FOR: SAFE®  
FOR: SAFE®  
FOR: SAFE®  
FOR: SAFE®  
FOR: SAFE®  
FOR: SAFE®

**FOR: FIAT®**

G.Z 7001-9956 CL-7.P  
FOR: CLAUSOR®  
FOR: GIOBERT®

4... 100-309 FAB-2  
FOR: FAAB®

F 01-78 FEM-1I  
H 01-78 FEM-2I  
FOR: FEMSA®

E 01-78 FEM-1D  
G 01-78 FEM-2D  
FOR: FEMSA®

J 3001-6732 N 6001-7000 FI-1  
FOR: GIOBERT®

J 3001-6732 N 6001-7000 FI-10  
FOR: GIOBERT®

Concerning the marks and commercial denominations see legal warning.  
Concerniente a las marcas y denominaciones comerciales ver aviso legal.  
Marka eta izendapen komertzialiei dagokienez, ikus lege-oharra.  
Concernant les marques et dénominations commerciales voir la note dans l'index.



Beziehen auf die marke und handelsname sehen sie die notiz im Impressum.  
Relativamente às marcas e denominações comerciais, ver aviso legal.  
Jeśli chodzi o znaki i nazwy handlowe, patrz Informacje prawne.



FOR: FIAT®

**Z-GR**  
 7001-9956  
**FI-2D**  
 G  
 2001-4530  
 G-Z  
 7001-9956  
**FI-3D**  
 G  
 7001-9956  
**FI-12**  
 FOR: GIOBERT®

**Z-GR**  
 7001-9956  
**FI-2D.P3**  
 G  
 2001-4530  
 G-Z  
 7001-9956  
**FI-3D.P3**  
 G  
 7001-9956  
**FI-12.P3**  
 FOR: GIOBERT®

FOR: ALFA ROMEO®  
 CITROEN®  
 FIAT®  
 INNOCENTI®  
 LANCIA®  
 SEAT®  
 YUGO ZASTAVA®

2001-4530  
 G-Z  
 7001-9956  
**FI-3D.P**  
 G  
 7001-9956  
**FI-12.P**  
 FOR: GIOBERT®

FOR: ALFA ROMEO®  
 FIAT®  
 IVECO®

2001-4530  
 G-Z  
 7001-9956  
**FI-3D.P1**  
 G  
 7001-9956  
**FI-12.P1**  
 FOR: GIOBERT®

G  
 2001-4530  
 G-Z  
 7001-9956  
**FI-3D.P2**  
 FOR: GIOBERT®

FOR: FIAT®

G  
 2001-4530  
 G-Z  
 7001-9956  
**FI-3D.P4**  
 FOR: GIOBERT®

G  
 2001-4530  
 G-Z  
 7001-9956  
**FI-3D.P5**  
 FOR: GIOBERT®

FOR: ALFA ROMEO®  
 AUTOBIANCHI®  
 CITROEN®  
 FERRARI®  
 FIAT®  
 INNOCENTI®  
 LANCIA®  
 PEUGEOT®  
 YUGO ZASTAVA®

K 3301-4886  
 K 7001-8092  
 T 5000-6027  
 T 7001-8092  
 S 0501-3278  
 H 7001-8092  
**FI-6I**  
 FOR: GIOBERT®

K 3301-4886  
 K 7001-8092  
 T 5000-6027  
 T 7001-8092  
 S 0501-3278  
 H 7001-8092  
**FI-6I.P**  
 FOR: GIOBERT®

FOR: FERRARI®  
 FIAT®  
 INNOCENTI®  
 LANCIA®

K 3301-4886  
 K 7001-8092  
 T 5000-6027  
 T 7001-8092  
 S 0501-3278  
 H 7001-8092  
**FI-6I.P2**  
 FOR: GIOBERT®

FOR: FERRARI®  
 FIAT®  
 CAGIVA®

FOR: FIAT®

X  
 3301-4886  
**FI-7I**  
 FOR: GIOBERT®  
 FOR: NEIMAN®-SIPA®

Y  
 7001-9956  
**FI-8I**  
 FOR: GIOBERT®  
 FOR: ARMAN®

Y  
 7001-9956  
**FI-8I.P**  
 FOR: GIOBERT®  
 FOR: ARMAN®

Y  
 7001-9956  
**FI-8I.P1**  
 FOR: GIOBERT®  
 FOR: ARMAN®

M  
 0001-1050  
**FI-9I**  
 FOR: GIOBERT®

FOR: FIAT®

M  
 0001-1050  
**FI-9I.P**  
 FOR: GIOBERT®

N 6001-7000  
 J 3001-6732  
 V 0001-3051  
 V 5001-8058  
 AB 6001-6891  
**FI-11**  
 FOR: GIOBERT®

N 6001-7000  
 J 3001-6732  
 V 0001-3051  
 V 5001-8058  
 AB 6001-6891  
**FI-11.P**  
 FOR: GIOBERT®

W  
 0001-9640  
**FI-13**  
 FOR: GIOBERT®

W  
 0001-9640  
**FI-13.P**  
 FOR: GIOBERT®

FOR: RAYTON FISSORE®-STEYR PUCH®-APRILIA®  
 FOR: RAYTON FISSORE®-STEYR PUCH®-APRILIA®  
 FOR: ALFA ROMEO®-FIAT®-LANCIA®  
 FOR: ALFA ROMEO®-FIAT®-LANCIA®

FOR: FIAT®

W  
 0001-9640  
**FI-13.P1**  
 FOR: GIOBERT®

W  
 0001-9640  
**FI-14.P**  
 FOR: GIOBERT®

**FI-15**  
 FOR: GIOBERT®

**FIA-2**  
 FOR: FIAT®

FOR: ASTON MARTIN®  
 AUTOBIANCHI®  
 DAIMLER®  
 FIAT®  
 JAGUAR®  
 JENSEN®  
 LOTUS®  
 PREMIER®  
 SEAT®  
 TRIUMPH®  
 YUGO ZASTAVA®

SCANIA®  
 FK  
 1-3040  
**FO-FK**  
 FOR: ARMAN®-DOM®-JUGODENT®-WASO®

FR  
 1-3040  
 4001-6000  
**FO-FR**  
 FOR: FORD®

FOR: FIAT®

FOR: ASTON MARTIN®  
 AUTOBIANCHI®  
 DAIMLER®  
 FIAT®  
 JAGUAR®  
 JENSEN®  
 LOTUS®  
 PREMIER®  
 SEAT®  
 TRIUMPH®  
 YUGO ZASTAVA®

SCANIA®  
 FK  
 1-3040  
**FO-FK.P**  
 FOR: ARMAN®-DOM®-JUGODENT®-WASO®

FR  
 1-3040  
 4001-6000  
**FO-FR.P**  
 FOR: FORD®

3  
 0501-1000  
**IMS-3**  
 FOR: SAFE®

4  
 0501-1000  
**AF-21**  
 FOR: CROMODORA®-FIST®-JMSA®

3  
 0501-1000  
**IMS-3.P**  
 FOR: SAFE®

4  
 0501-1000  
**AF-21.P**  
 FOR: CROMODORA®-FIST®-JMSA®

1  
 0501-1000  
**IMS-5**  
 FOR: SAFE®

2  
 0501-1000  
**AF-19**  
 FOR: CROMODORA®-FIST®-JMSA®

1  
 0501-1000  
**IMS-5.P**  
 FOR: SAFE®

2  
 0501-1000  
**AF-19.P**  
 FOR: CROMODORA®-FIST®-JMSA®

1  
 0501-1000  
**IMS-12**  
 FOR: IMSA®

1  
 0501-1000  
**IMS-13**  
 FOR: SAFE®

1  
 0501-1000  
**IMS-13.P**  
 FOR: SAFE®

1  
 0501-1000  
**IMS-12**  
 FOR: IMSA®

1  
 0501-1000  
**IMS-13**  
 FOR: SAFE®

FOR: EBRO®  
 FIAT®  
 LADA VAZ®  
 MOSKVITCH®  
 PEUGEOT®  
 RENAULT®  
 TALBOT SIMCA®  
 ZAZ®  
 DAF®  
 VOLVO®

.....A/Z  
 A/Z.....  
 A/Z.....A/Z  
 1 AL 7  
 .....A/Z  
 0 AL 9  
**NE-3**  
 FOR: NEIMAN®

.....A/Z  
 A/Z.....  
 A/Z.....A/Z  
 1 AL 7  
 .....A/Z  
 0 AL 9  
**NE-3D**  
 FOR: CLAUSSOR®

Concerning the marks and commercial denominations see legal warning.  
 Concerniente a las marcas y denominaciones comerciales ver aviso legal.  
 Marka eta izendapen komertzialiei dagokienez, ikus lege-oharra.  
 Concernant les marques et denominations commerciales voir la note dans l'index.

**JMA** Opening the future

**JMA** Opening the future

Beziehen auf die Marke und Handelsname sehen sie die Notiz im Impressum.  
 Relativamente às marcas e denominações comerciais, ver aviso legal.  
 Jeśli chodzi o znaki i nazwy handlowe, patrz Informacje prawne.





FOR: FIAT (ARGENTINA)®

.A/Z....  
.A/Z....A/Z  
A/Z....A/Z  
0 AL 8  
1 AL 7  
A/Z....1 AL 7 Y A A L E  
NE-4.P

11-34-39....  
1 AL 7  
34-39....A/Z  
1 AL 7  
NE-15I.P FOR: NEIMAN®  
NE-15D.P FOR: NEIMAN®

NE-46 FOR: NEIMAN (RA)®  
NE-53 FOR: NEIMAN (RA)®

SI-3 FOR: SISPA®  
SI-2D FOR: AUTOBLOCK®

FOR: FIAT (TURQUIA)®

A 0501-3278 0,4,6,8,9  
AF-7I FOR: SIPEA®  
AF-7D FOR: SIPEA®  
AF-7I.P FOR: SIPEA®  
AF-8I FOR: SIPEA®  
AF-8I.P FOR: SIPEA®  
AF-9I FOR: SIPEA®

G 01-78  
AF-8D FOR: SIPEA®  
AF-8D.P FOR: SIPEA®  
AF-9D FOR: SIPEA®  
AF-9D.P FOR: SIPEA®

F 01-78  
FEM-1I FOR: FEMSA®  
FEM-2I FOR: FEMSA®  
FEM-3I FOR: FEMSA®

E 01-78  
FEM-1D FOR: FEMSA®  
FEM-2D FOR: FEMSA®  
FEM-3D FOR: FEMSA®

Z-GR 7001-9956  
FI-2D FOR: GIOBERT®  
FI-3D FOR: GIOBERT®  
FI-12 FOR: GIOBERT®

Z-GR 7001-9956  
FI-2D.P3 FOR: GIOBERT®  
FI-3D.P3 FOR: GIOBERT®  
FI-12.P3 FOR: GIOBERT®

FOR: FIAT (ARG.)®

FOR: FIAT (BRASIL)®

B....501-3278  
B....0-4-6-8-9  
SIP-3 FOR: SIPEA®  
FOR: ARTEB®-CLAUSOR®-NEIMAN®

J 3001-6732 N 6001-7000  
FI-1 FOR: GIOBERT®

J 3001-6732 N 6001-7000  
FI-10 FOR: GIOBERT®

J 3001-6732 N 6001-7000  
FI-1.P FOR: GIOBERT®

J 3001-6732 N 6001-7000  
FI-10.P FOR: GIOBERT®

N 6001-7000 J 3001-6732 V 0001-3051 V 5001-8058 AB 6001-6891  
FI-11 FOR: GIOBERT®

N 6001-7000 J 3001-6732 V 0001-3051 V 5001-8058 AB 6001-6891  
FI-11.P FOR: GIOBERT®

FOR: FIAT (TURQUIA)®

G 2001-4530 G-Z 7001-9956  
FI-3D.P2 FOR: GIOBERT®

G 2001-4530 G-Z 7001-9956  
FI-6I FOR: GIOBERT®

K 3301-4886 K 7001-8092 T 5000-6027 T 7001-8092 S 0501-3278 H 7001-8092  
FI-6I.P FOR: GIOBERT®

FOR: ALFA ROMEO®  
AUTOBIANCHI®  
CITROEN®  
FERRARI®  
FIAT®  
INNOCENTI®  
LANCIA®  
PEUGEOT®  
YUGO ZASTAVA®  
CAGIVA®  
DUCATI®  
FANTIC MOTOR®  
GARELLI®  
GILERA®

K 3301-4886 K 7001-8092 T 5000-6027 T 7001-8092 S 0501-3278 H 7001-8092  
FI-6I.P FOR: GIOBERT®

FOR: FERRARI®  
FIAT®  
INNOCENTI®  
LANCIA®

W 0001-9640  
FI-13 FOR: GIOBERT®

W 0001-9640  
FI-13.P FOR: GIOBERT®

FOR: FIAT (BRASIL)®

FOR: FIAT (TURQUIA)®

W 0001-9640  
FI-13.P7 FOR: GIOBERT®  
FOR: SIPEA®

3 0501-1000 IMS-3 FOR: SAFE®  
4 0501-1000 AF-21 FOR: SAFE®

3 0501-1000 IMS-3.P FOR: SAFE®  
4 0501-1000 AF-21.P FOR: SAFE®

1 0501-1000 IMS-5 FOR: SAFE®  
2 0501-1000 AF-19 FOR: SAFE®

1 0501-1000 IMS-5.P FOR: SAFE®  
2 0501-1000 AF-19.P FOR: SAFE®

1 0501-1000 IMS-13.P FOR: SAFE®

1 0501-1000 IMS-12 FOR: IMSA®  
FOR: SAFE®

SI-3 FOR: SISPA®  
SI-3D FOR: AUTOBLOCK®

W 0001-9640  
FI-14.P FOR: GIOBERT®

FOR: ASTON MARTIN®  
AUTOBIANCHI®  
DAIMLER®  
FIAT®  
JAGUAR®  
JENSEN®  
LOTUS®  
PREMIER®  
SEAT®  
TRIUMPH®  
YUGO ZASTAVA®

FR 1-3040 4001-6000  
FO-FK FOR: FORD®  
FO-FR FOR: FORD®

FR 1-3040 4001-6000  
FO-FK.P FOR: FORD®  
FO-FR.P FOR: FORD®

3 0501-1000 IMS-3 FOR: SAFE®  
4 0501-1000 AF-21 FOR: SAFE®

3 0501-1000 IMS-3.P FOR: SAFE®  
4 0501-1000 AF-21.P FOR: SAFE®

1 0501-1000 IMS-5 FOR: SAFE®  
2 0501-1000 AF-19 FOR: SAFE®

1 0501-1000 IMS-5.P FOR: SAFE®  
2 0501-1000 AF-19.P FOR: SAFE®

IMS-13 FOR: SAFE®

IMS-13.P FOR: SAFE®

Concerning the marks and commercial denominations see legal warning.  
Concerniente a las marcas y denominaciones comerciales ver aviso legal.  
Marka eta izendapen komertzialiei dagokienez, ikus lege-oharra.  
Concernant les marques et denominations commerciales voir la note dans l'index.

**JMA** Opening the future

**JMA** Opening the future

Beziehen auf die marke und handelsname sehen sie die notiz im Impressum.  
Relativamente às marcas e denominações comerciais, ver aviso legal.  
Jeśli chodzi o znaki i nazwy handlowe, patrz Informacje prawne.

FOR: FIAT(TURQ.)®

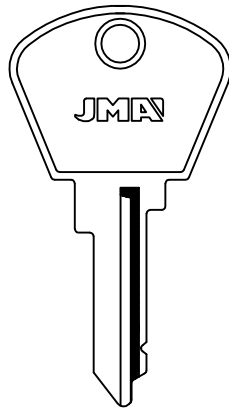

....4-6-8-9



FOR: SIPEA®

FOR: MAGNETI MARELLI® -NEIMAN®

FOR: FIAT IVECO®

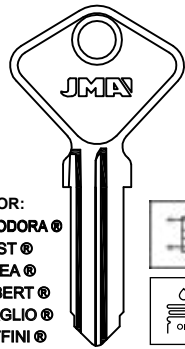

FOR:  
CROMODORA®  
FIST®  
GIOBERT®  
MIRAGLIO®  
RUFFINI®

6

100-309



AF-5I

2

100-309



AF-6I

FOR: SAFE®



8

100-309



AF-5D

4

100-309



AF-6D

A  
0501-3278  
0,4,6,8,9



AF-7I

H

O1-78



AF-8I

F

O1-78



AF-9I

FOR: SIPEA®  
FOR: SAFE®



G

O1-78



AF-8D

E

O1-78



AF-9D

FOR: SIPEA®  
FOR: SAFE®



A  
0501-3278  
0,4,6,8,9



AF-7I.P

H

O1-78



AF-8I.P

F

O1-78



AF-9I.P

FOR: SIPEA®  
FOR: SAFE®

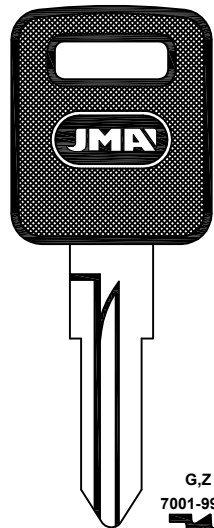

G,Z  
7001-9956



CL-7.P

FOR: CLAUSOR®  
FOR: GIOBERT®

FOR: FIAT IVECO®

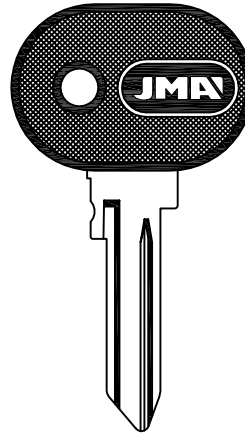

Y  
7001-9956



FI-8I.P1

FOR: GIOBERT®  
FOR: ARMAN®

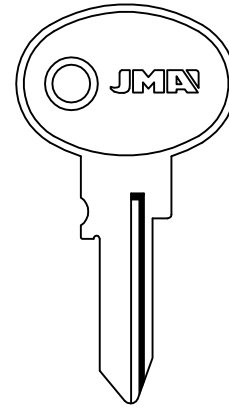

M  
0001-1050



FI-9I

FOR: GIOBERT®

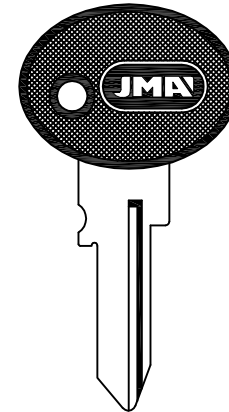

M  
0001-1050



FI-9I.P

FOR: GIOBERT®

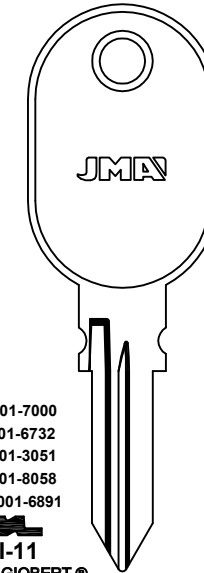

N 6001-7000  
J 3001-6732  
V 0001-3051  
V 5001-8058  
AB 6001-6891



FI-11

FOR: GIOBERT®

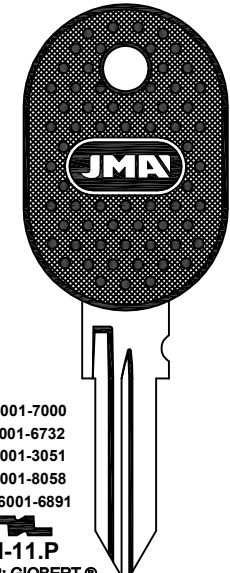

N 6001-7000  
J 3001-6732  
V 0001-3051  
V 5001-8058  
AB 6001-6891



FI-11.P

FOR: GIOBERT®

FOR: FIAT IVECO®

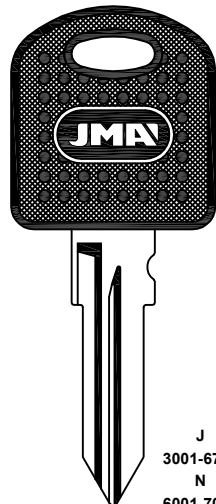

J  
3001-6732

N  
6001-7000



FI-1.P8

FOR: GIOBERT®

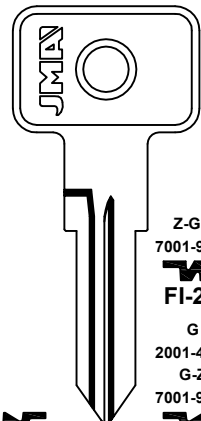

FI-3

FOR: GIOBERT®

Z-GR  
7001-9956



FI-2D

G

2001-4530

G-Z



FI-3D

G

7001-9956



FI-12

G

7001-9956

FOR: GIOBERT®

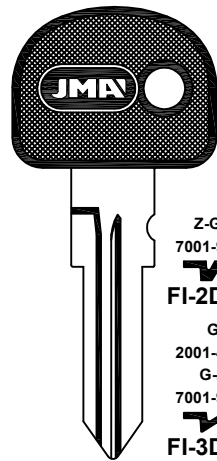

Z-GR  
7001-9956



FI-2D.P3

G

2001-4530

G-Z



FI-3D.P3

G

7001-9956



FI-12.P3

G

7001-9956

FOR: GIOBERT®

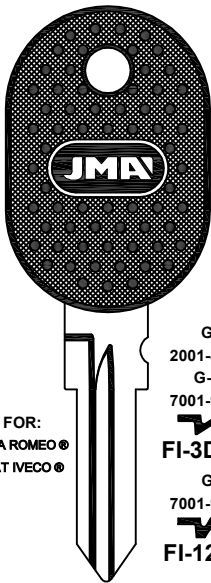

G  
2001-4530

G-Z



FI-3D.P1

G

7001-9956



FI-12.P1

G

7001-9956



FI-6I

G

7001-9956

FOR: ALFA ROMEO®  
FIAT IVECO®

K 3301-4886  
K 7001-8092  
T 5000-6027  
T 7001-8092  
S 0501-3278  
H 7001-8092

FOR: GIOBERT®

FOR:  
ALFA ROMEO®  
AUTOBIANCHI®  
CITROEN®  
FERRARI®  
FIAT®  
INNOCENTI®  
LANCIA®  
PEUGEOT®  
YUGO ZASTAVA  
CAGIVA®  
DUCATI®  
FANTIC MOTOR®  
GARELLI®  
GILERA®

FOR: GIOBERT®

FOR: FIAT IVECO®

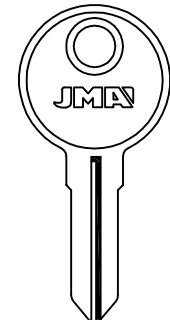

LAT.



FIS-1D

FOR: FIST®

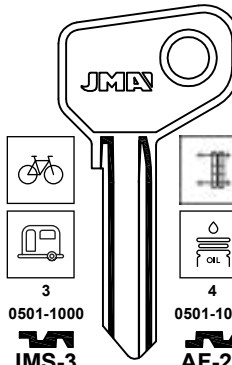

3  
0501-1000



IMS-3

1

0501-1000



IMS-5

2

0501-1000



AF-19

FOR: CROMODORA® -FIST® -IMSA®

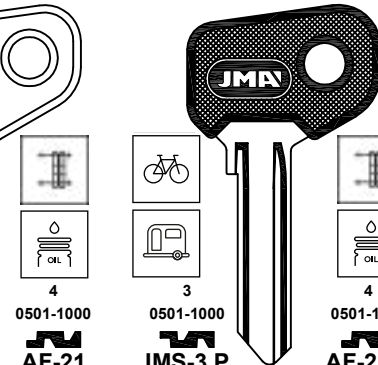

3  
0501-1000



IMS-3.P

1

0501-1000



IMS-5.P

2

0501-1000



AF-19.P

FOR: CROMODORA® -FIST® -IMSA®

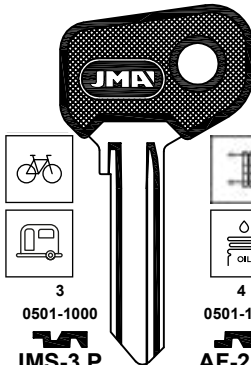

3  
0501-1000



IMS-13.P

FOR: SAFE®

FOR: SAFE®

FOR: CROMODORA® -FIST® -IMSA®

FOR: CROMODORA® -FIST® -IMSA®

FOR: CROMODORA® -FIST® -IMSA®

FOR: CROMODORA® -FIST® -IMSA®

FOR: CROMODORA® -FIST® -IMSA®

FOR: CROMODORA® -FIST® -IMSA®

FOR: CROMODORA® -FIST® -IMSA®

FOR: CROMODORA® -FIST® -IMSA®

FOR: CROMODORA® -FIST® -IMSA®

FOR: CROMODORA® -FIST® -IMSA®

FOR: CROMODORA® -FIST® -IMSA®

FOR: CROMODORA® -FIST® -IMSA®

FOR: CROMODORA® -FIST® -IMSA®

FOR: CROMODORA® -FIST® -IMSA®

FOR: CROMODORA® -FIST® -IMSA®

FOR: CROMODORA® -FIST® -IMSA®

FOR: CROMODORA® -FIST® -IMSA®

FOR: CROMODORA® -FIST® -IMSA®

FOR: CROMODORA® -FIST® -IMSA®

FOR: CROMODORA® -FIST® -IMSA®

FOR: CROMODORA® -FIST® -IMSA®

FOR: CROMODORA® -FIST® -IMSA®

FOR: CROMODORA® -FIST® -IMSA®

FOR: CROMODORA® -FIST® -IMSA®

FOR: CROMODORA® -FIST® -IMSA®

FOR: CROMODORA® -FIST® -IMSA®

FOR: CROMODORA® -FIST® -IMSA®

FOR: CROMODORA® -FIST® -IMSA®

FOR: CROMODORA® -FIST® -IMSA®

FOR: CROMODORA® -FIST® -IMSA®

FOR: CROMODORA® -FIST® -IMSA®

FOR: CROMODORA® -FIST® -IMSA®

FOR: CROMODORA® -FIST® -IMSA®

FOR: CROMODORA® -FIST® -IMSA®

FOR: CROMODORA® -FIST® -IMSA®

FOR: CROMODORA® -FIST® -IMSA®

FOR: CROMODORA® -FIST® -IMSA®

FOR: CROMODORA® -FIST® -IMSA®

FOR: CROMODORA® -FIST® -IMSA®

FOR: CROMODORA® -FIST® -IMSA®

FOR: CROMODORA® -FIST® -IMSA®

FOR: CROMODORA® -FIST® -IMSA®

FOR: CROMODORA® -FIST® -IMSA®

FOR: CROMODORA® -FIST® -IMSA®

FOR: CROMODORA® -FIST® -IMSA®

FOR: CROMODORA® -FIST® -IMSA®

FOR: CROMODORA® -FIST® -IMSA®

FOR: CROMODORA® -FIST® -IMSA®

FOR: FORD®

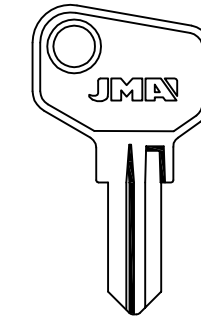

LAT.

15



AB-6I

FOR: PROAUTO®

14



AB-8I

FOR: ABSA®

13



AB-8D

FOR: ARFE® -FROSER® -KEYA®

FOR: FIAT IVECO®

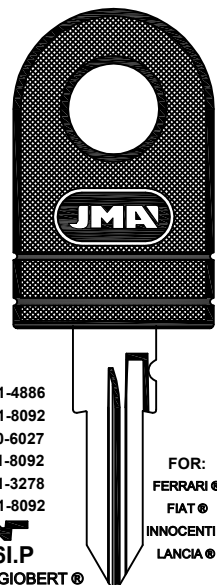

K 3301-4886  
K 7001-8092  
T 5000-6027  
T 7001-8092  
S 0501-3278  
H 7001-8092

FOR:

FERRARI®

FIAT®

INNOCENTI®

LANCIA®

FOR: GIOBERT®

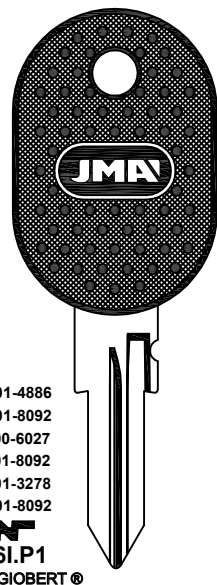

K 3301-4886  
K 7001-8092  
T 5000-6027  
T 7001-8092  
S 0501-3278  
H 7001-8092

FOR:

FERRARI®

FIAT®



FOR: FORD®

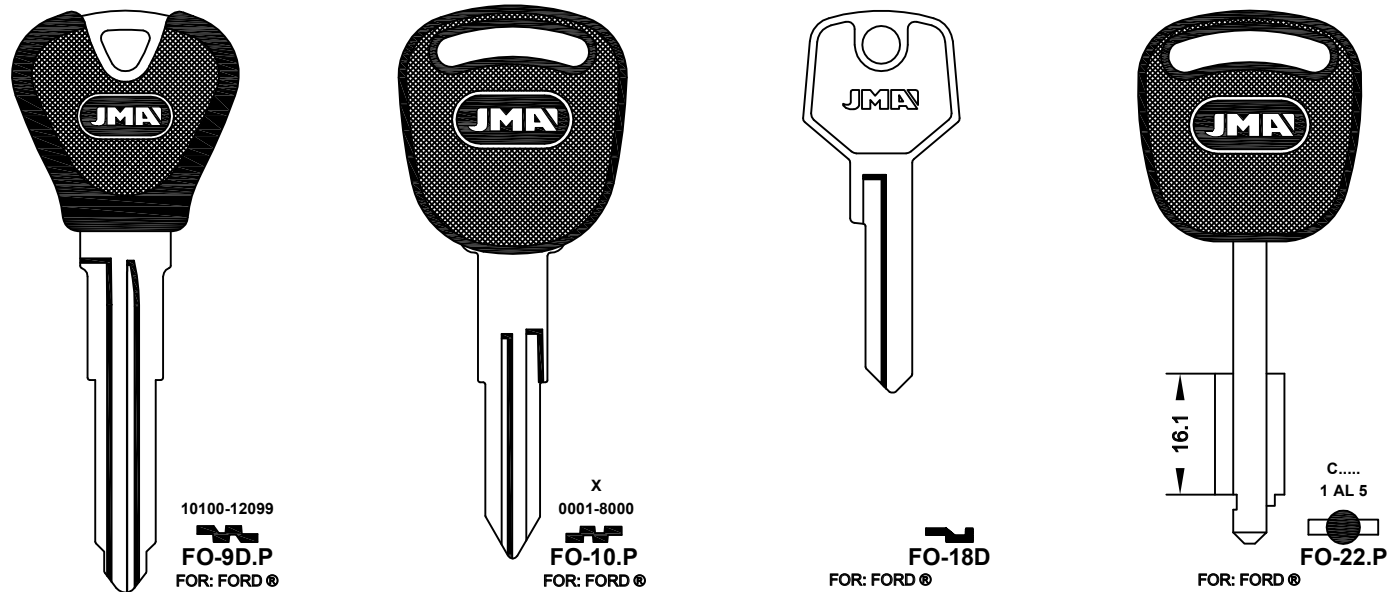

FOR: FORD®

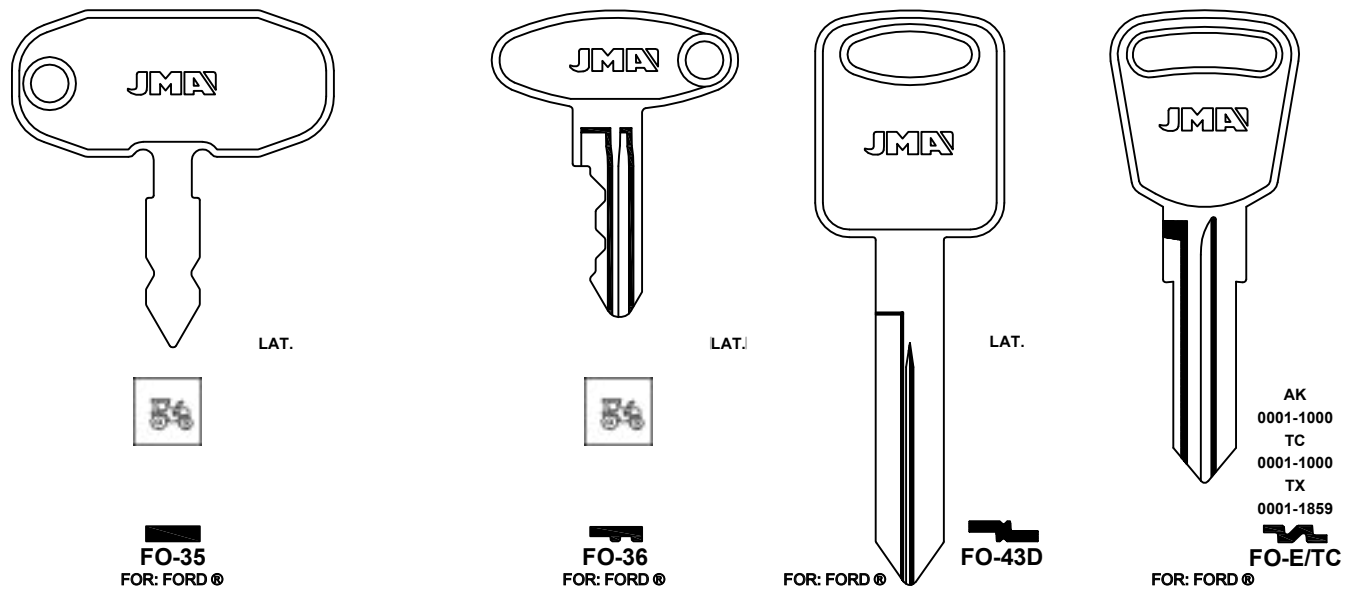

FOR: FORD®

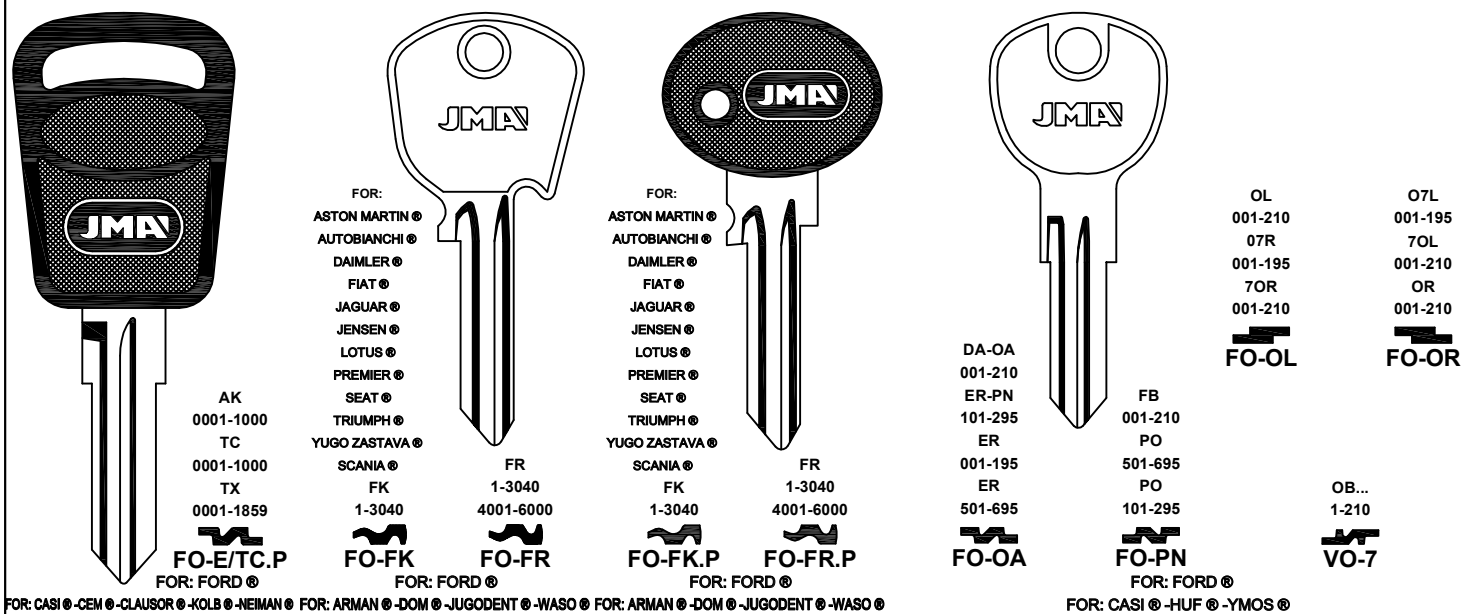

FOR: FORD®

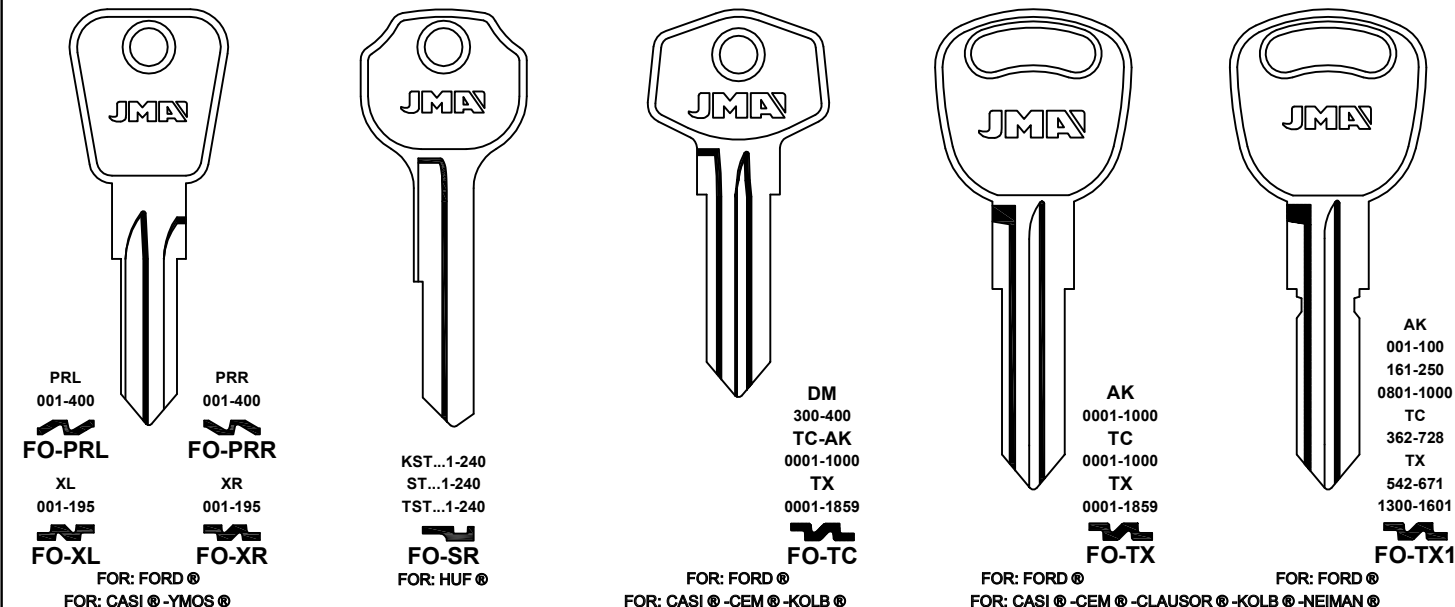

FOR: FORD®

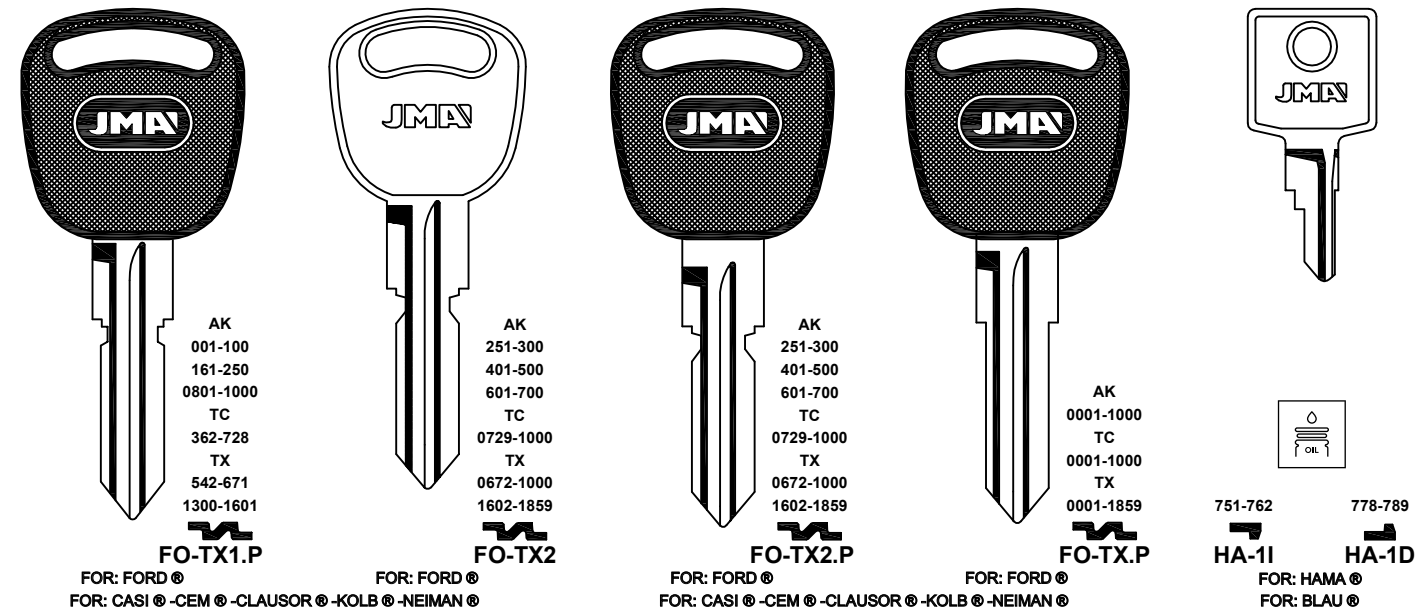

FOR: FORD®

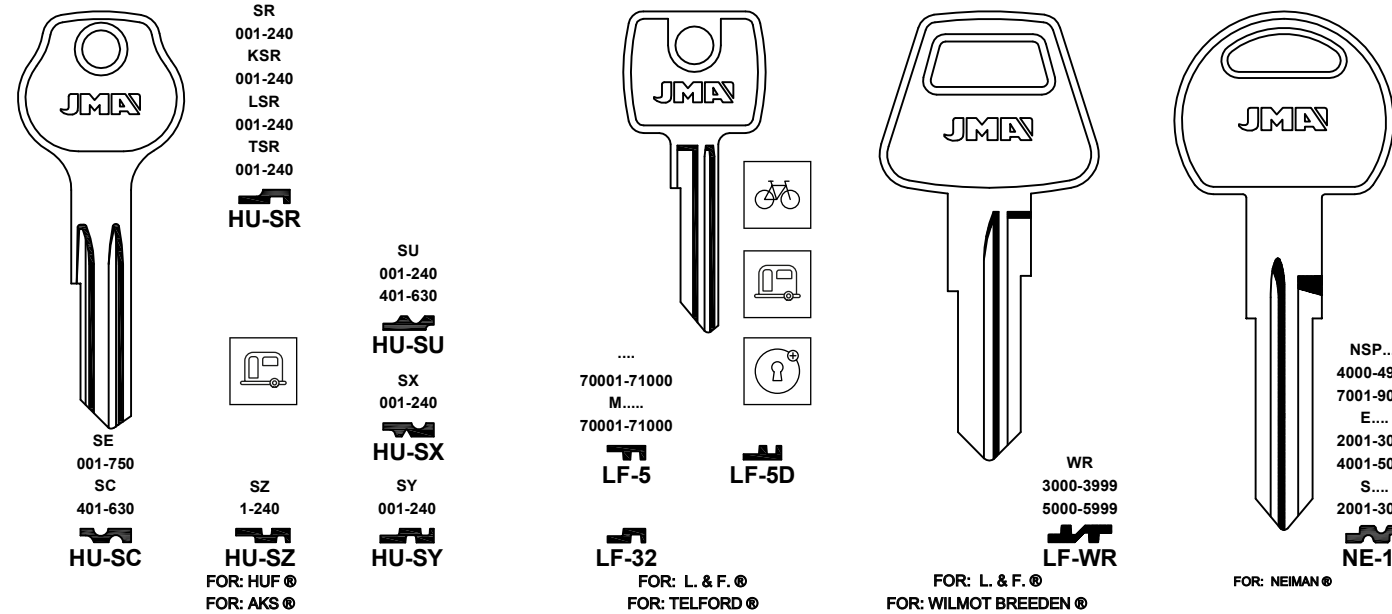

Concerning the marks and commercial denominations see legal warning.  
Concerniente a las marcas y denominaciones comerciales ver aviso legal.  
Marka eta izendapen komertzialiei dagokienez, ikus lege-oharra.  
Concernant les marques et denominations commerciales voir la note dans l'index.

FOR: FORD®

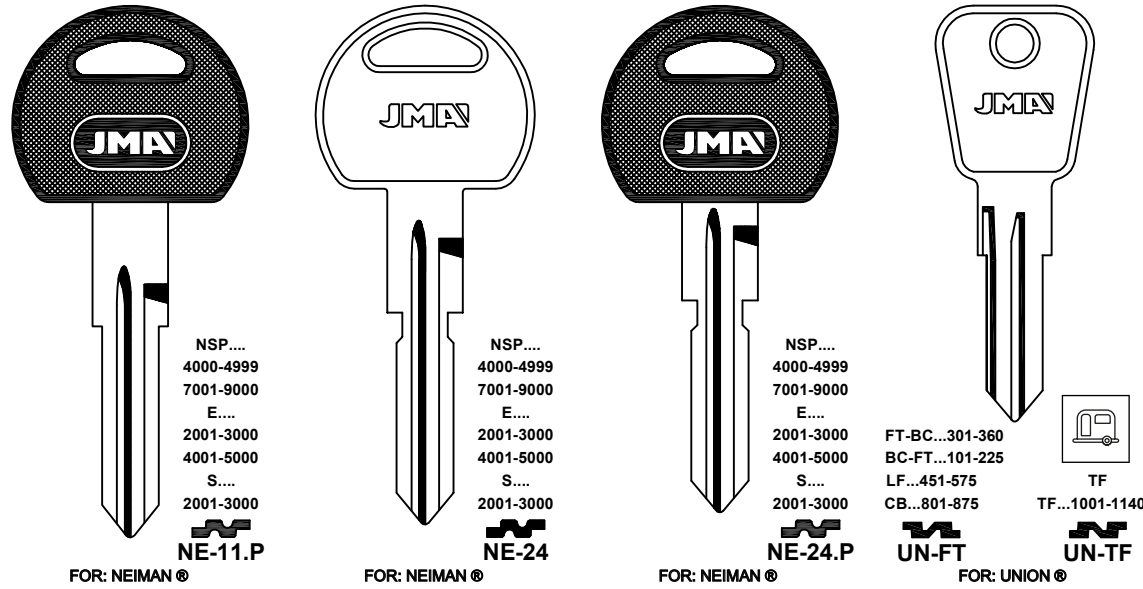

FOR: FORD(ARG.)®

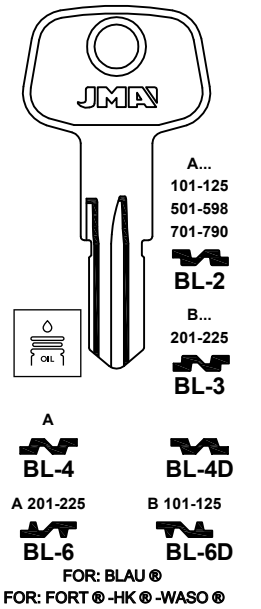

FOR: FORD (ARGENTINA)®

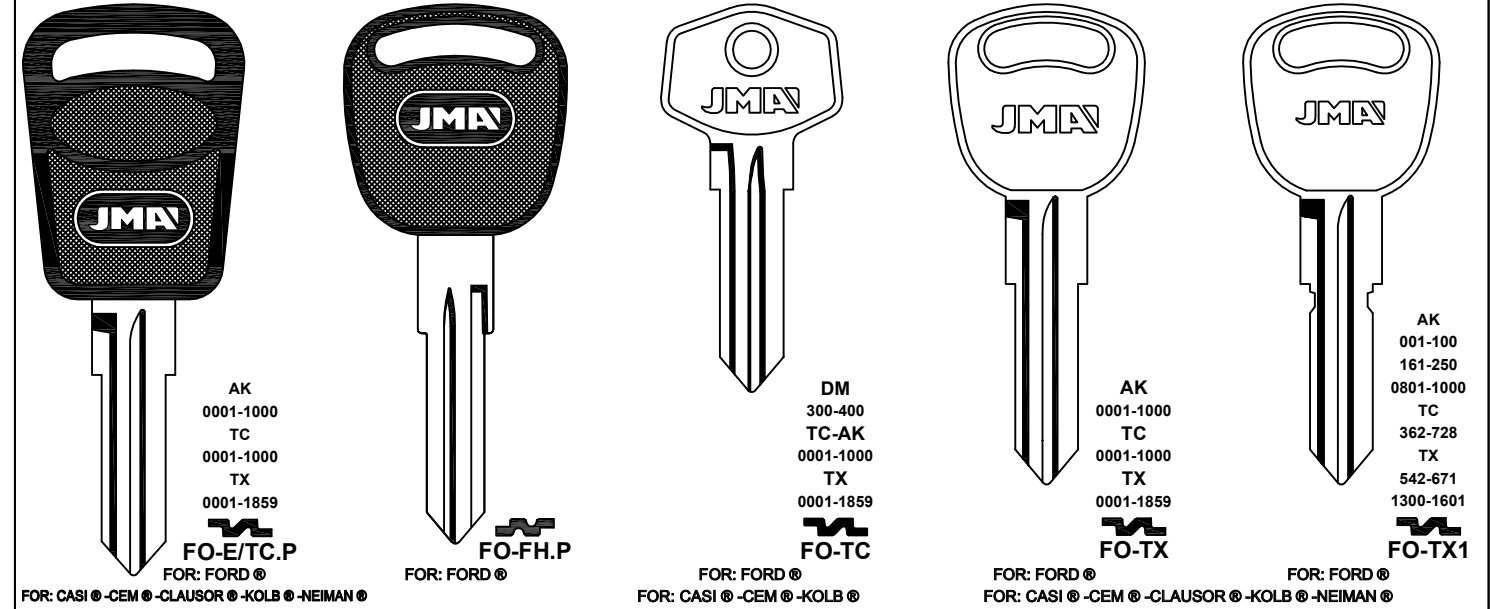

FOR: FORD (ARGENTINA)®

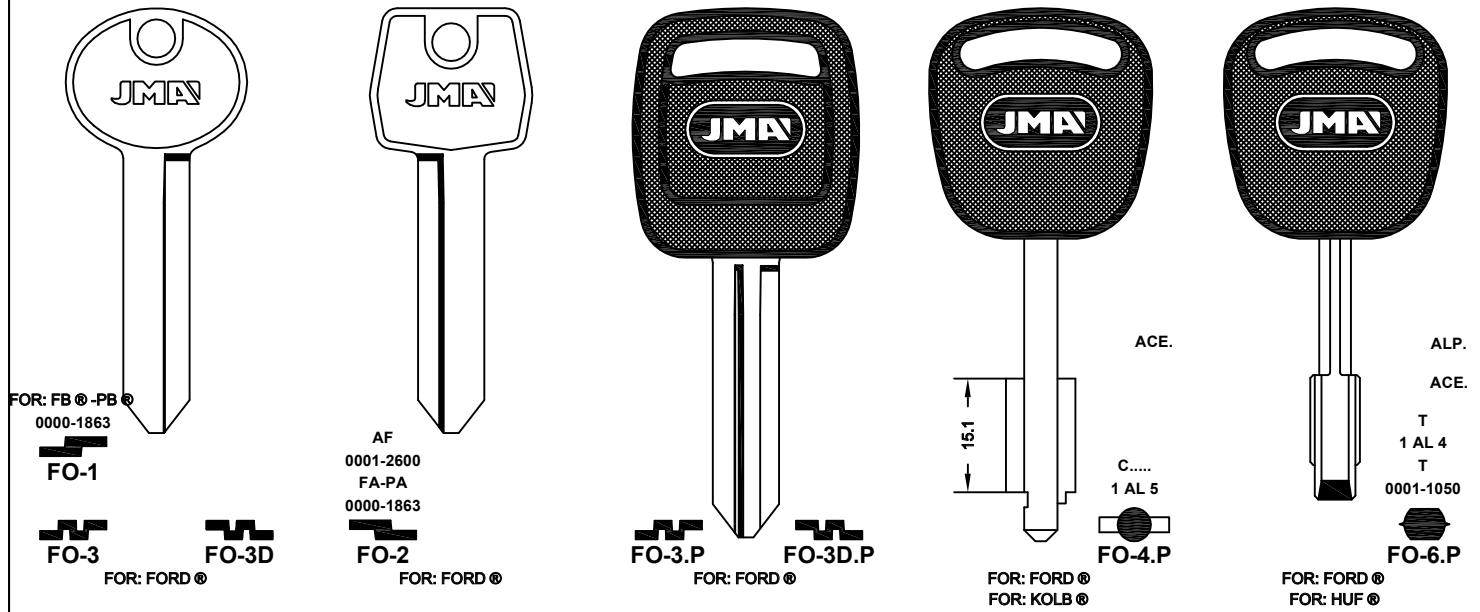

FOR: FORD (ARGENTINA)®

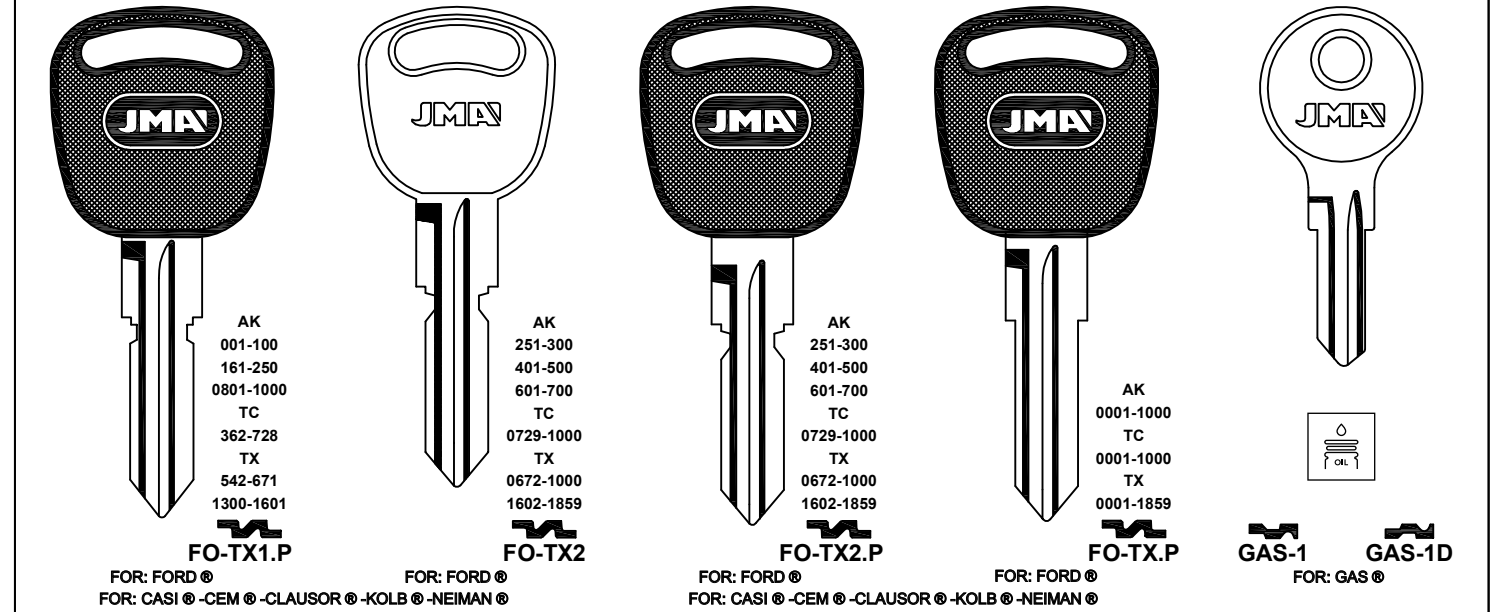

FOR: FORD (ARGENTINA)®

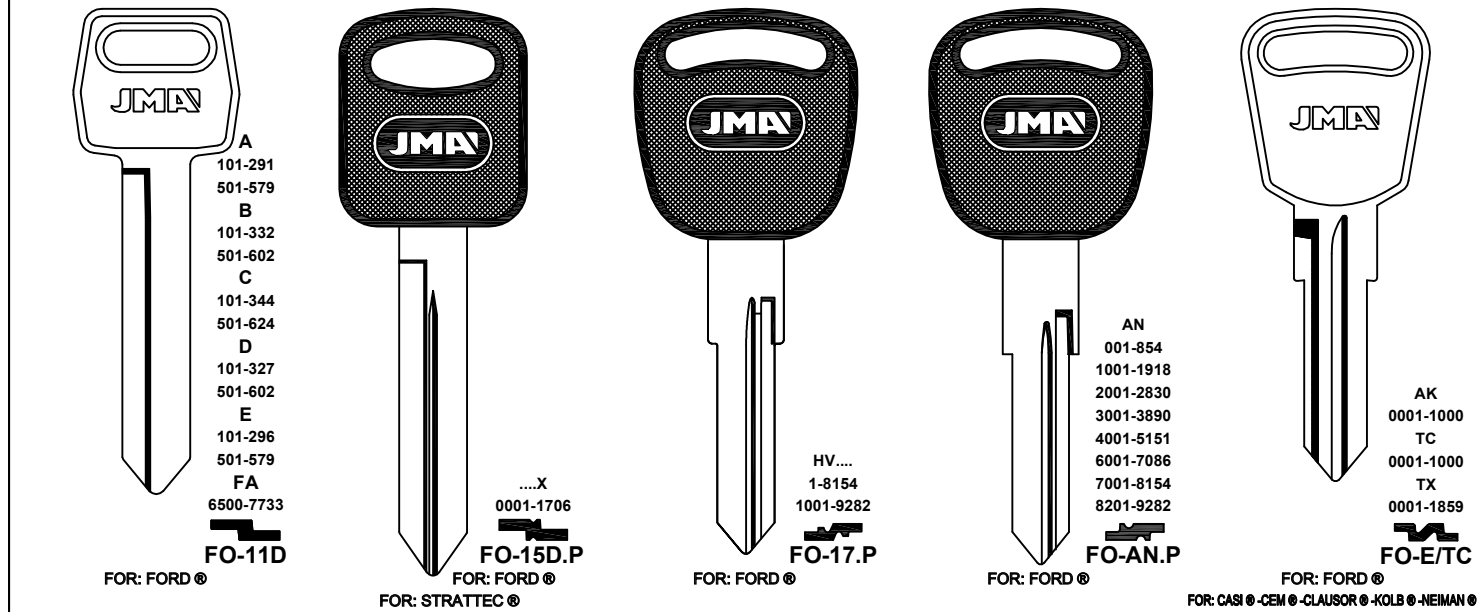

FOR: FORD (ARGENTINA)®

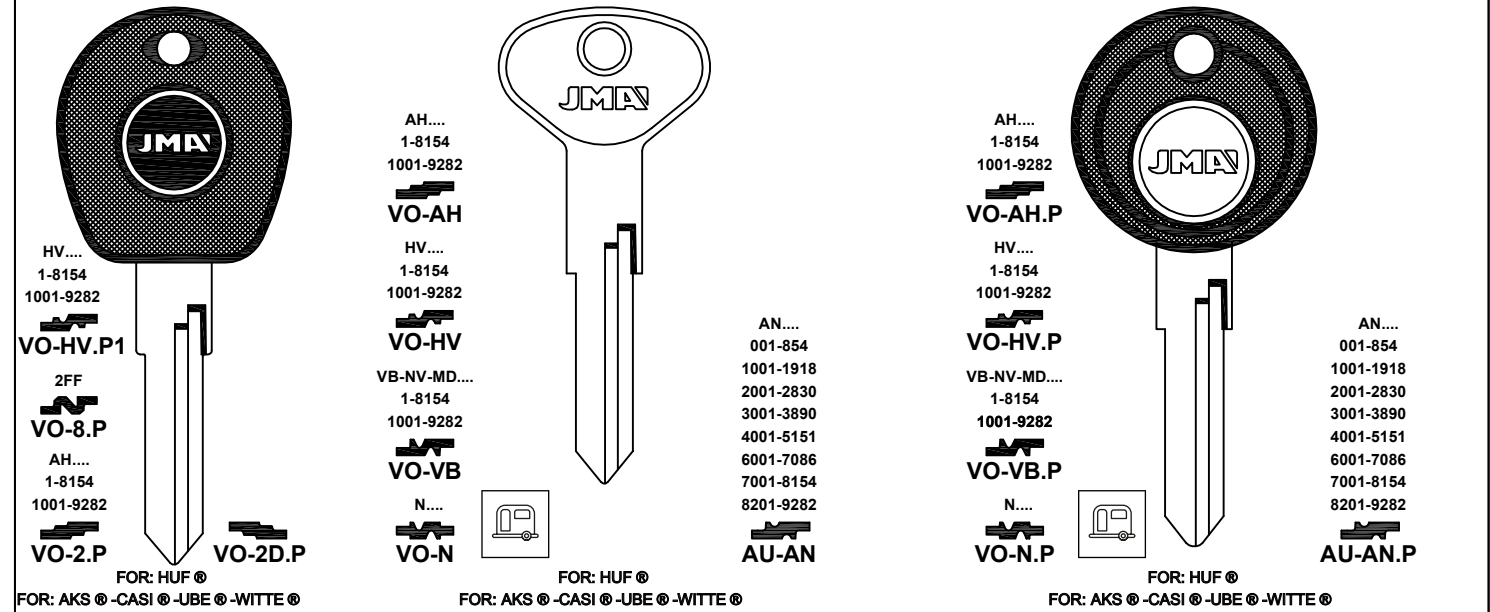

Concerning the marks and commercial denominations see legal warning.  
 Concerniente a las marcas y denominaciones comerciales ver aviso legal.  
 Marka eta izendapen komertzialiei dagokienez, ikus lege-oharra.  
 Concernant les marques et denominations commerciales voir la note dans l'index.

**JMA** Opening the future

**JMA** Opening the future

Beziehen auf die marke und handelsname sehen sie die notiz im Impressum.  
 Relativamente às marcas e denominações comerciais, ver aviso legal.  
 Jeśli chodzi o znaki i nazwy handlowe, patrz Informacje prawne.

FOR: FORD (AUSTRALIA) ®

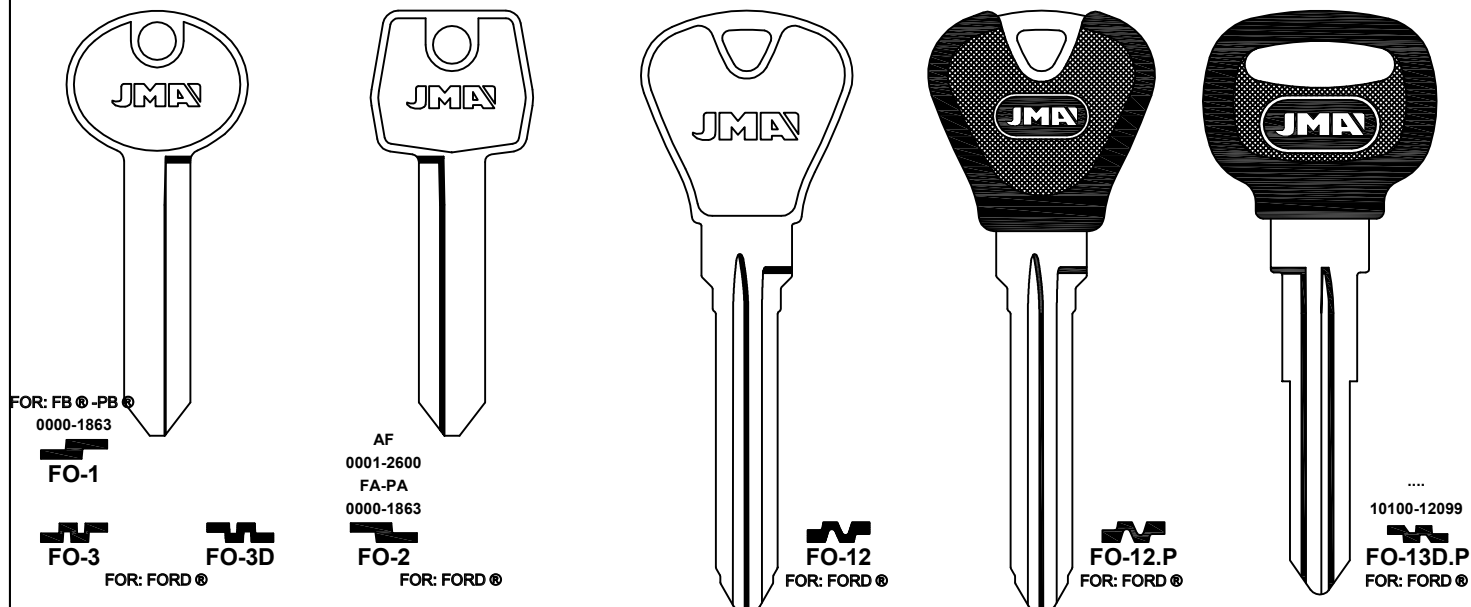

FOR: FORD (AUSTRALIA) ®

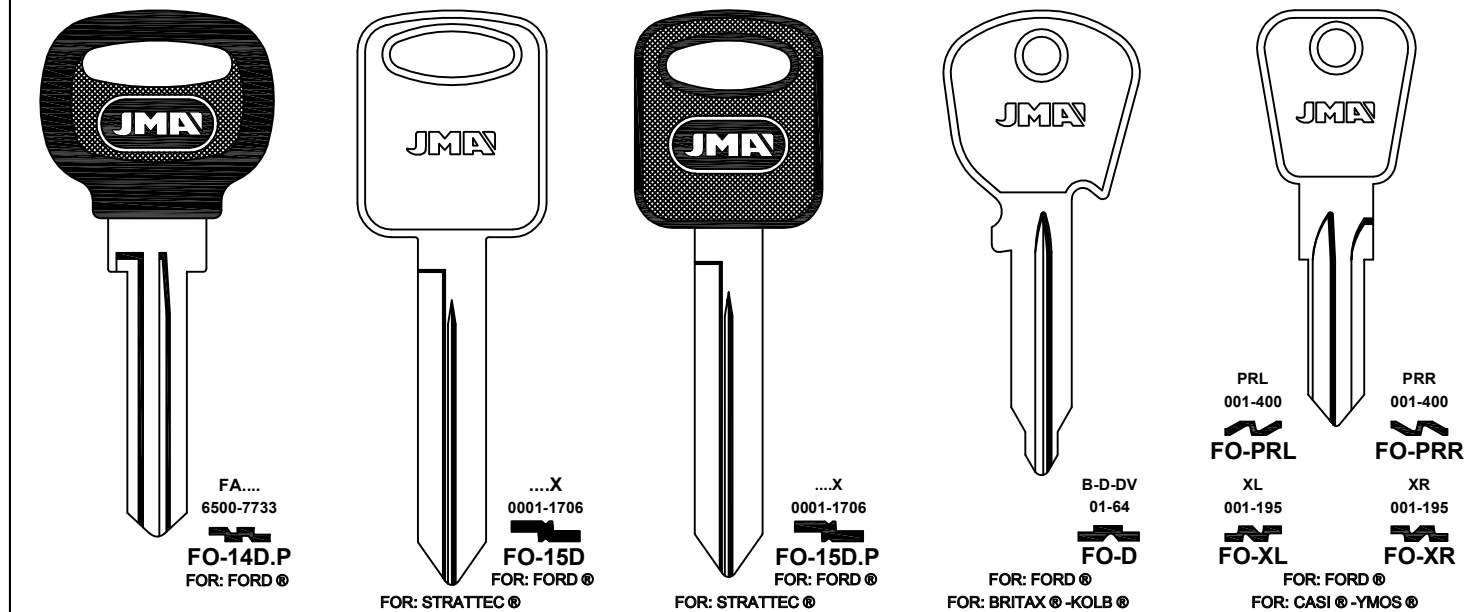

FOR: FORD (AUSTRALIA) ®

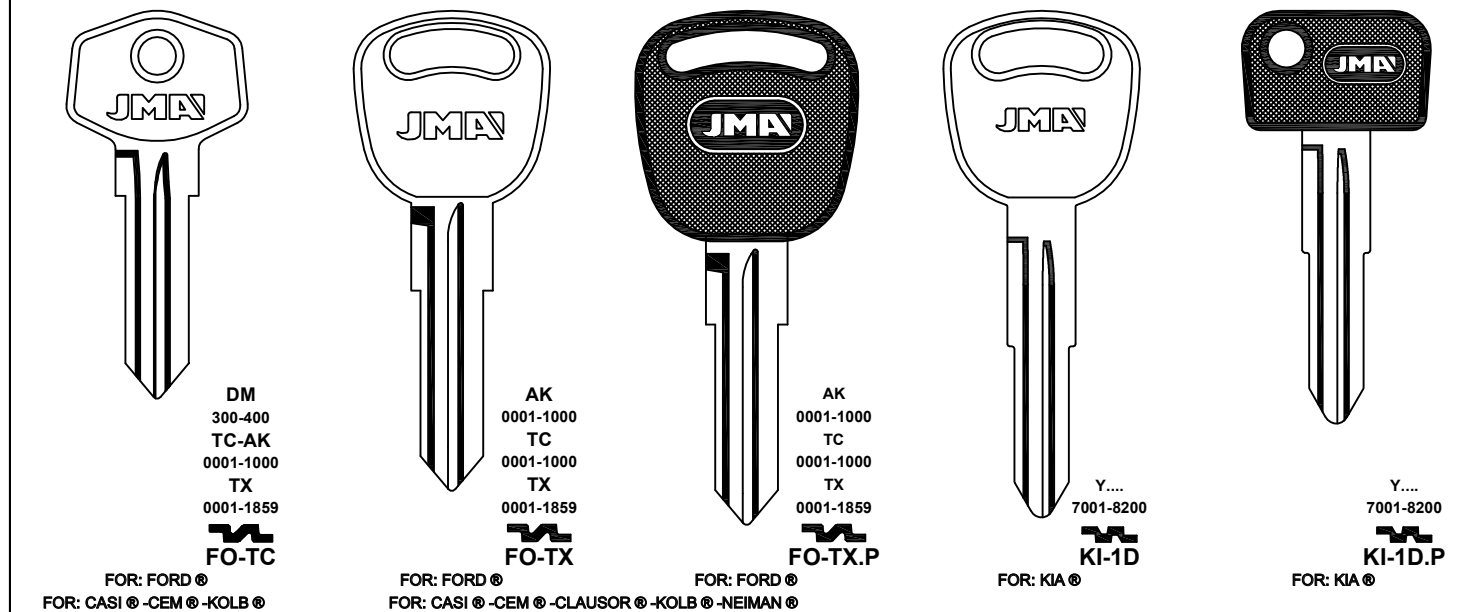

FOR: FORD (AUS.) ®

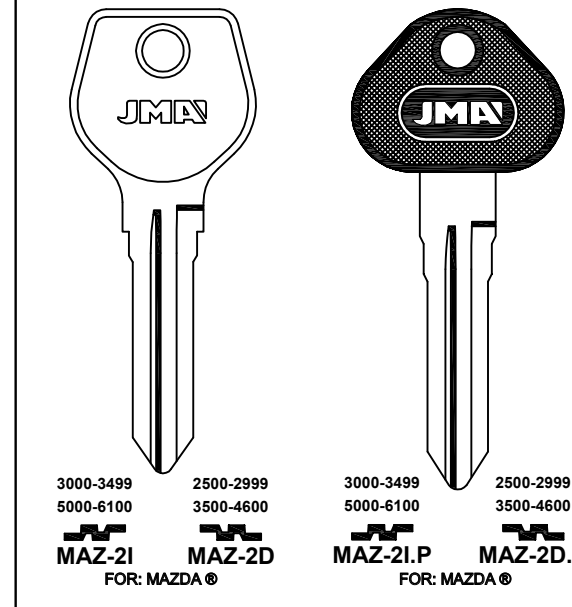

FOR: FORD (BRASIL) ®

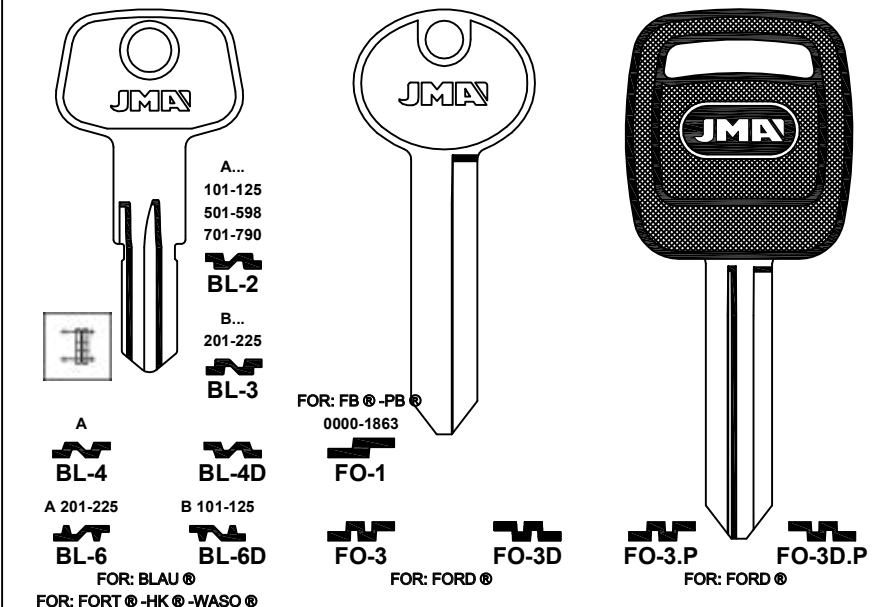

FOR: FORD (BRASIL) ®

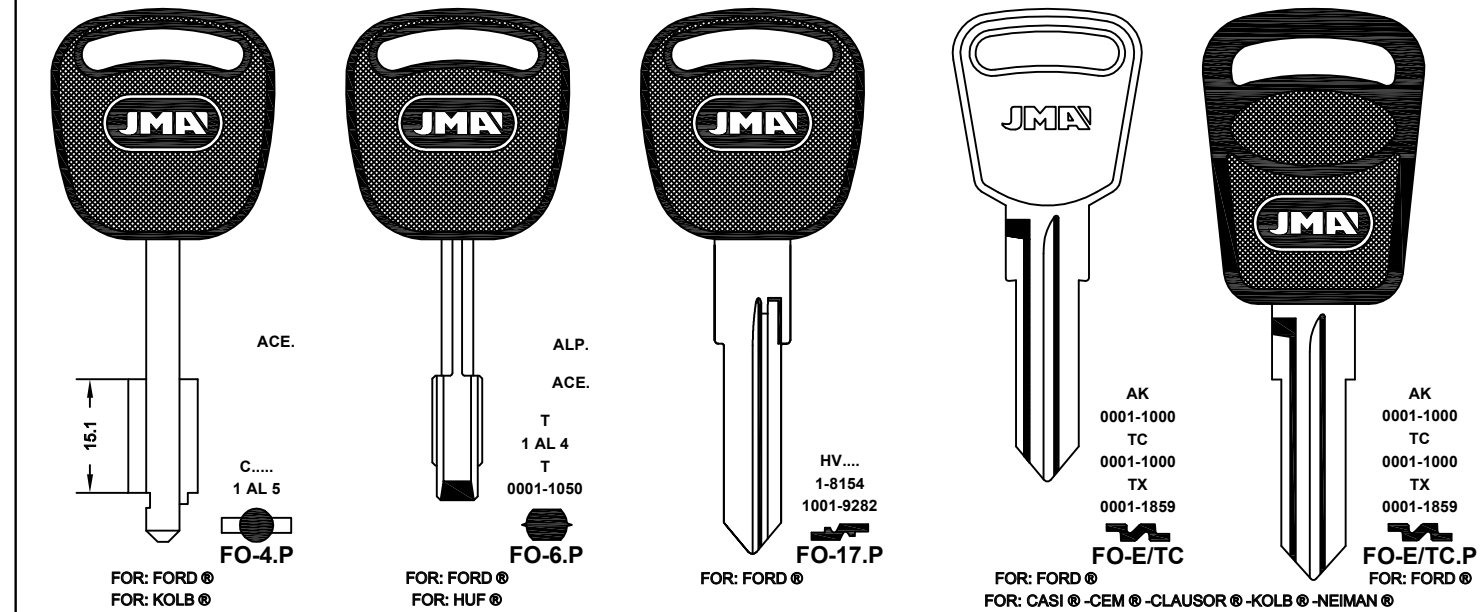

FOR: FORD (BRASIL) ®

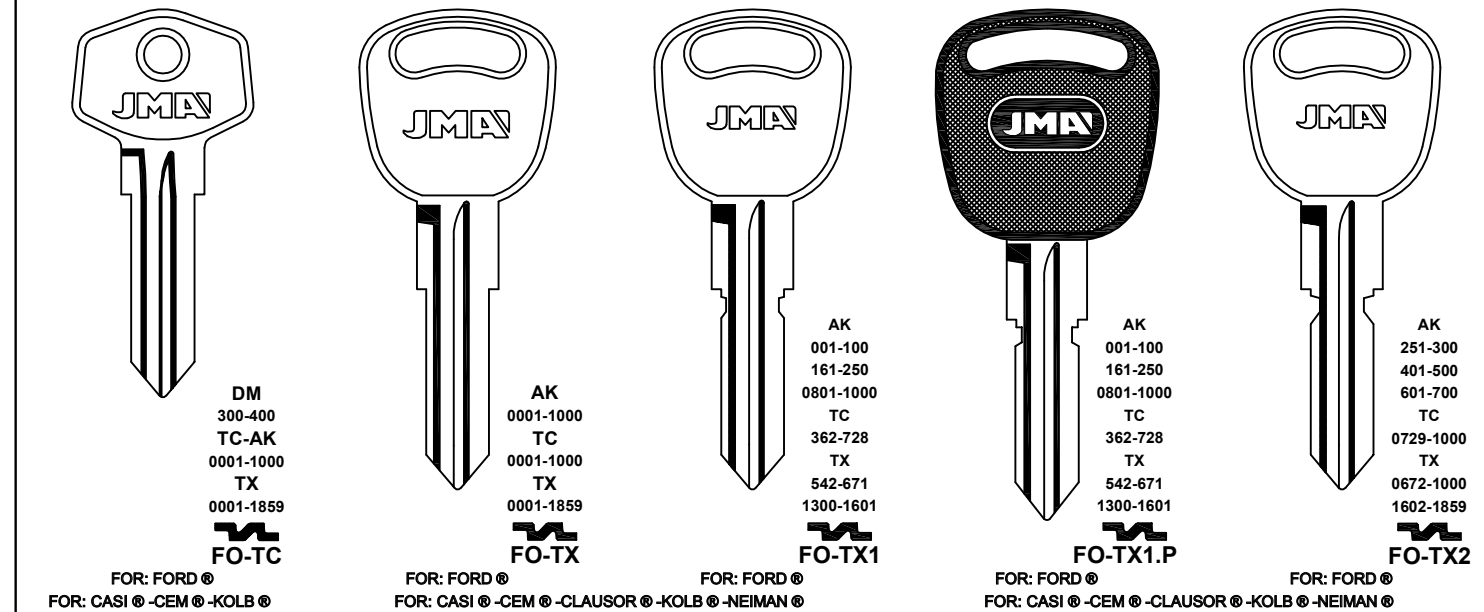

Concerning the marks and commercial denominations see legal warning.  
Concerniente a las marcas y denominaciones comerciales ver aviso legal.  
Marka eta izendapen komertzialiei dagokienez, ikus lege-oharra.  
Concernant les marques et dénominations commerciales voir la note dans l'index.

**JMA** Opening the future

**JMA** Opening the future

Beziehen auf die Marke und Handelsname sehen Sie die Notiz im Impressum.  
Relativamente às marcas e denominações comerciais, ver aviso legal.  
Jeśli chodzi o znaki i nazwy handlowe, patrz Informacje prawne.



FOR: FORD (BRASIL) ®

FOR: FORD (SOUTH AFRICA) ®

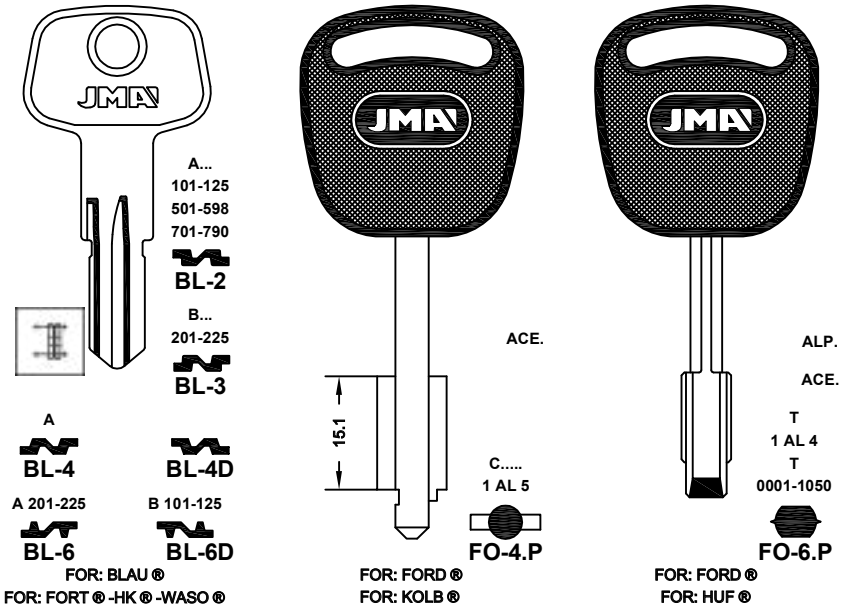
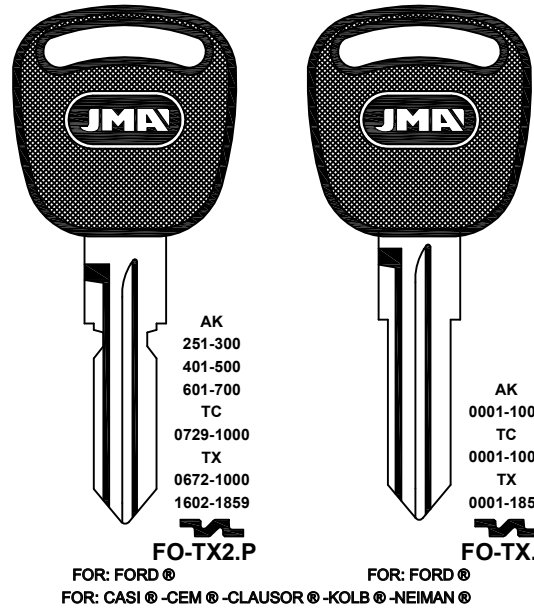

FOR: FORD (USA) ®

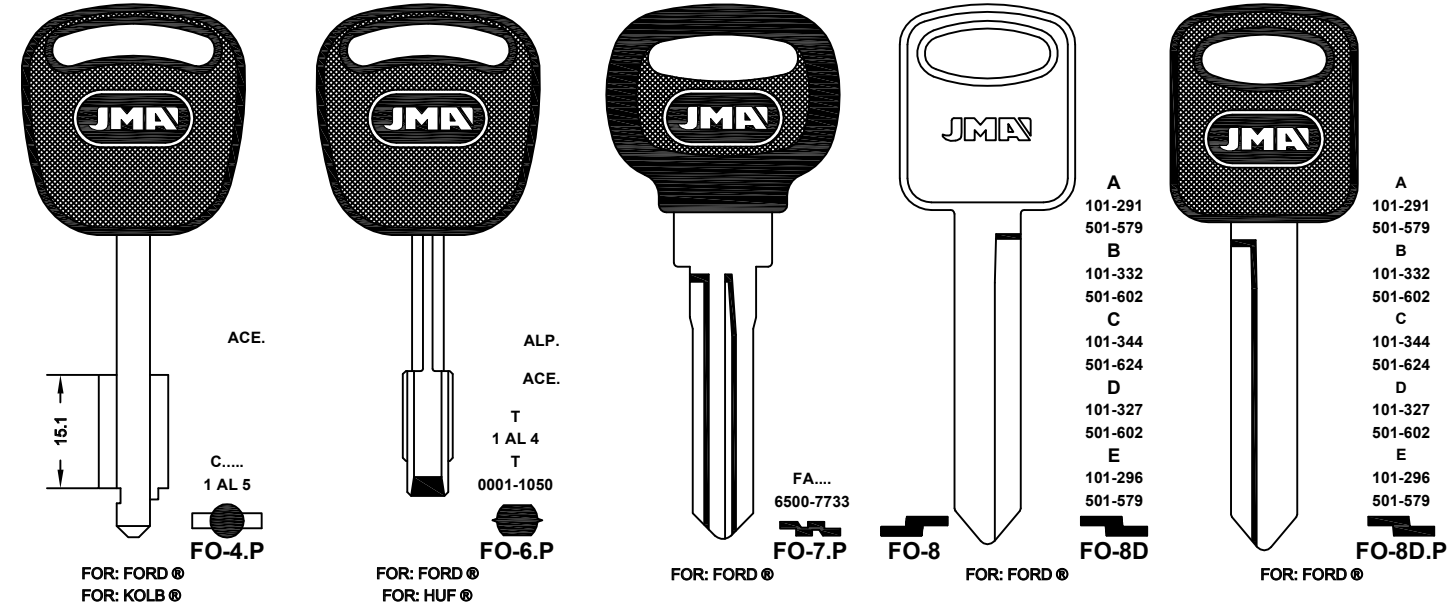

FOR: FORD (SOUTH AFRICA) ®

FOR: FORD (USA) ®

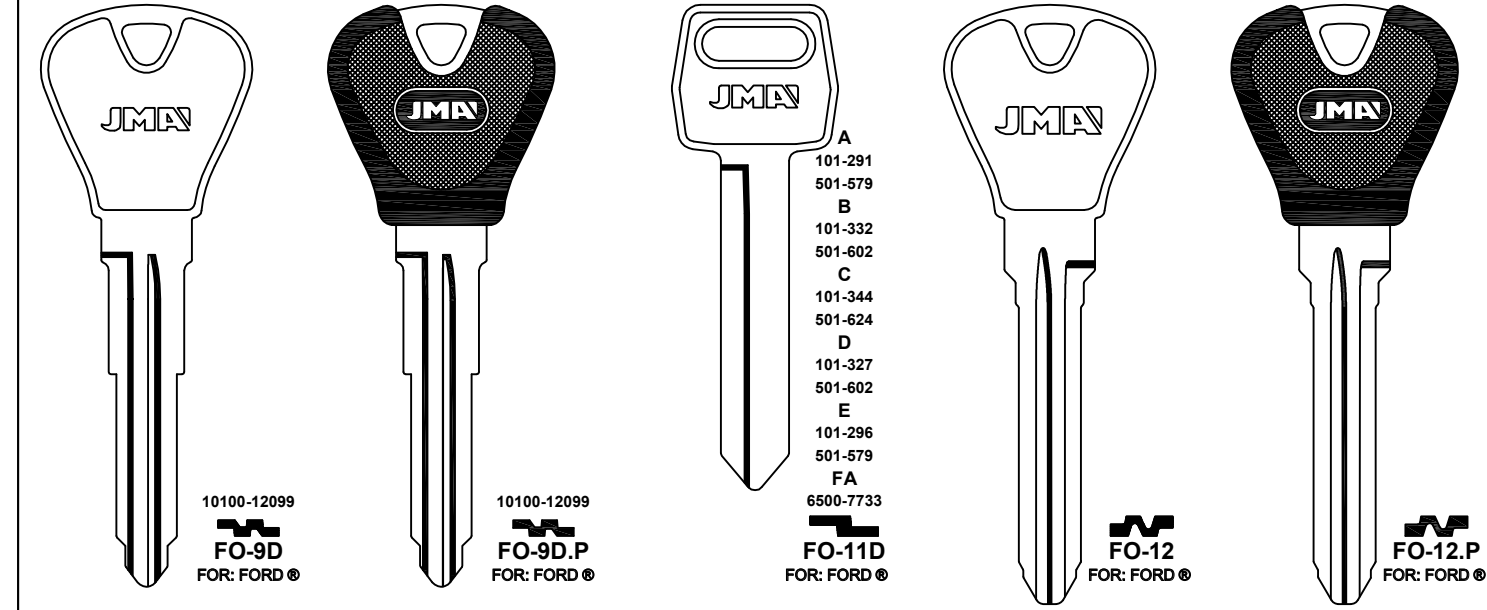
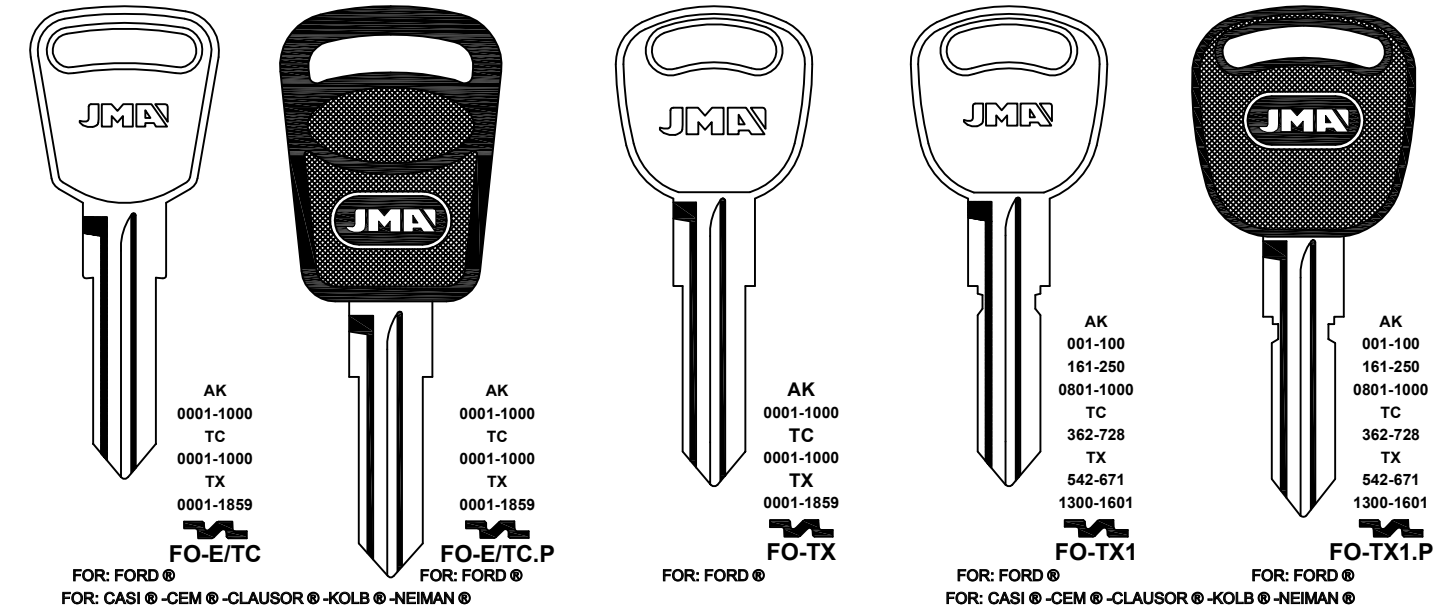

FOR: FORD (SOUTH AFRICA) ®

FOR: FORD (USA) ®

FOR: FORD (USA) ®

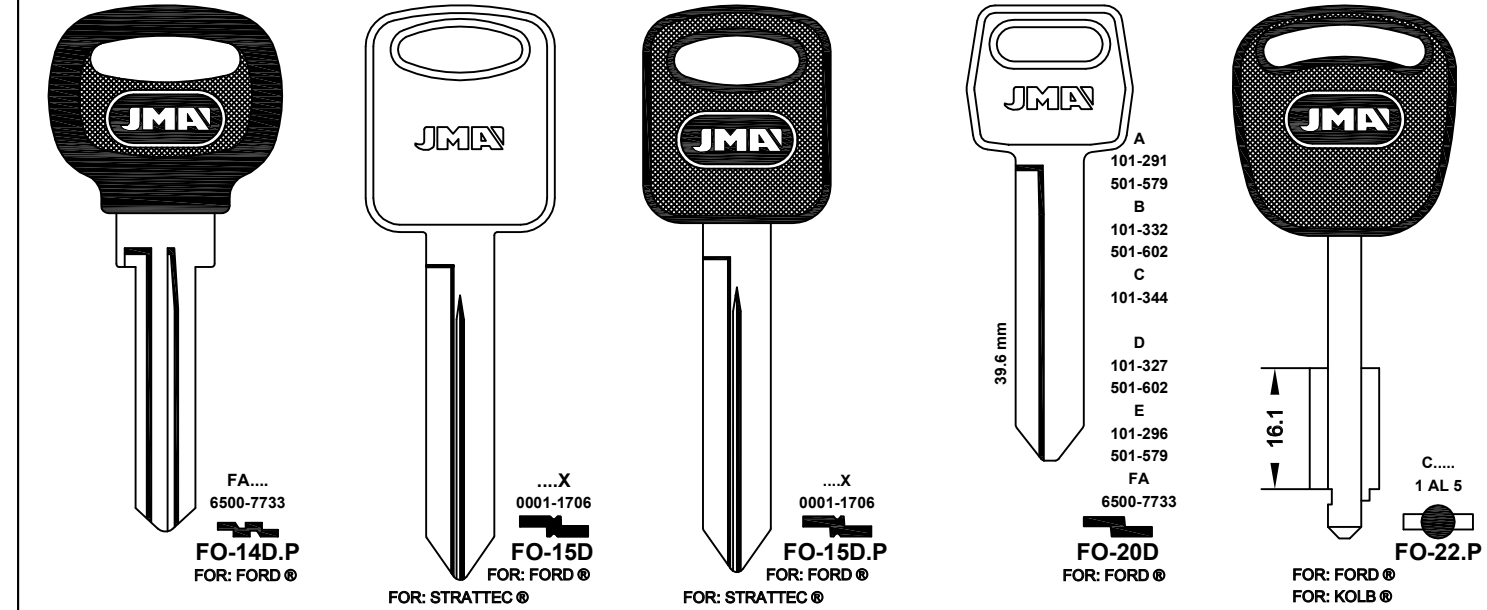
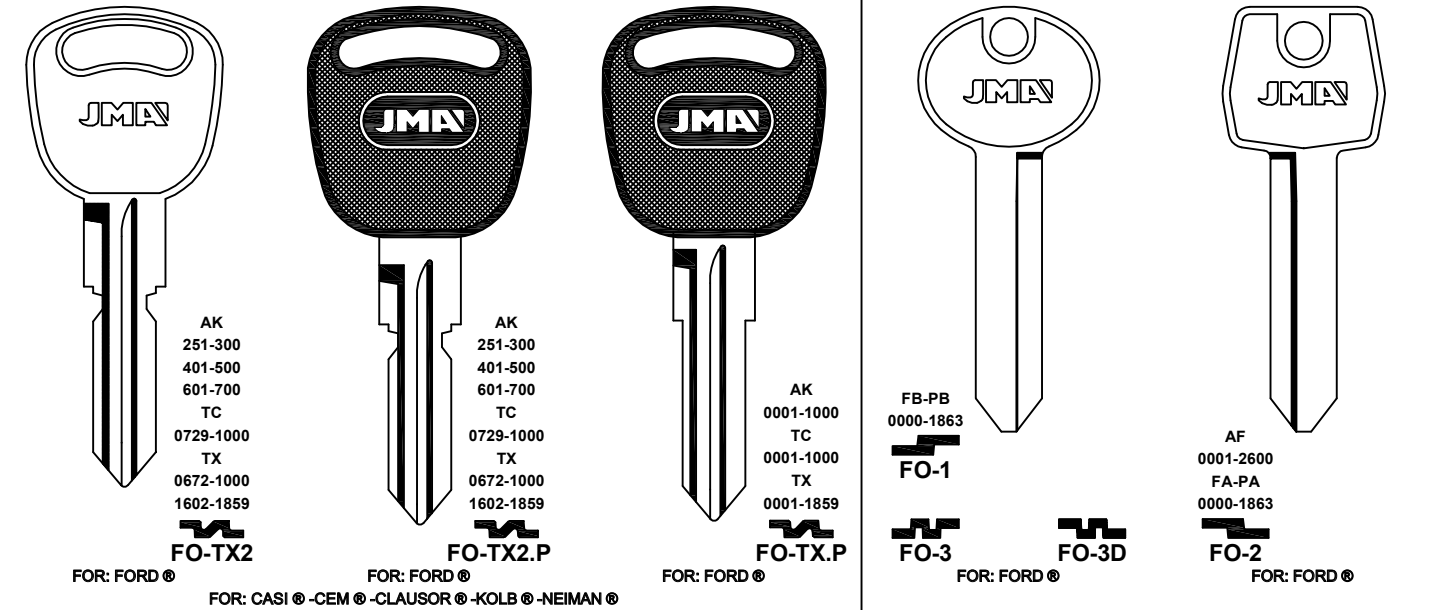

Concerning the marks and commercial denominations see legal warning.  
 Concerniente a las marcas y denominaciones comerciales ver aviso legal.  
 Marka eta izendapen komertzialiei dagokienez, ikus lege-oharra.  
 Concernant les marques et denominations commerciales voir la note dans l'index.

**JMA** Opening the future

**JMA** Opening the future

Beziehen auf die marke und handelsname sehen sie die notiz im Impressum.  
 Relativamente às marcas e denominações comerciais, ver aviso legal.  
 Jeśli chodzi o znaki i nazwy handlowe, patrz Informacje prawne.





FOR: G.M. (BUICK)®

FOR: G.M.(CADIL.)®

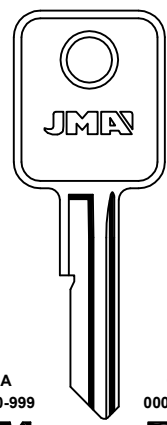

A  
000-999  
GM-A  
E  
000-999  
GM-E

FOR: G.M.®  
FOR: BRIGGS STRATTON®

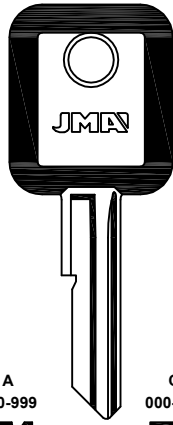

C  
000-999  
GM-C  
J  
000-999  
GM-J

FOR: G.M.®  
FOR: BRIGGS STRATTON®

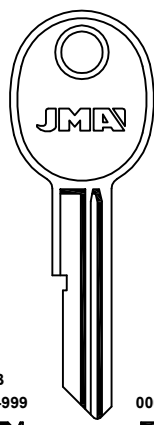

B  
000-999  
GM-B  
H  
000-999  
GM-H

FOR: G.M.®  
FOR: BRIGGS STRATTON®

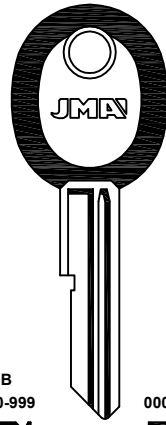

D  
000-999  
GM-D  
K  
000-999  
GM-K

FOR: G.M.®  
FOR: BRIGGS STRATTON®

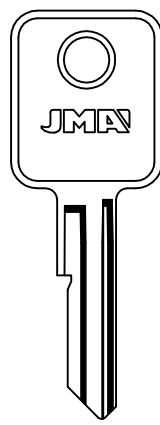

B  
000-999  
GM-B.P  
H  
000-999  
GM-H.P  
K  
000-999  
GM-K.P  
E,D  
225-814  
K  
0001-1000  
8000-9499  
BAS-1I  
BAS-1D  
FOR: BASCO®  
FOR: CORBIN®

FOR: G.M. (CADILLAC)®

FOR: G.M. (CHEVROLET)®

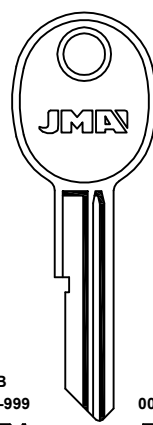

B  
000-999  
GM-B  
H  
000-999  
GM-H

FOR: G.M.®  
FOR: BRIGGS STRATTON®

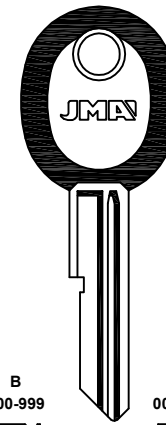

D  
000-999  
GM-D  
K  
000-999  
GM-K  
H  
000-999  
GM-H.P  
K  
000-999  
GM-K.P

FOR: G.M.®  
FOR: BRIGGS STRATTON®

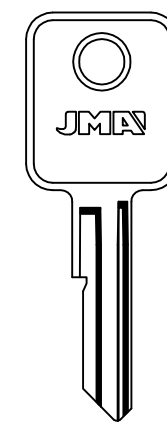

E,D  
225-814  
K  
0001-1000  
8000-9499  
BAS-1I  
BAS-1D  
FOR: BASCO®  
FOR: CORBIN®

FOR: G.M. (CHEVROLET)®

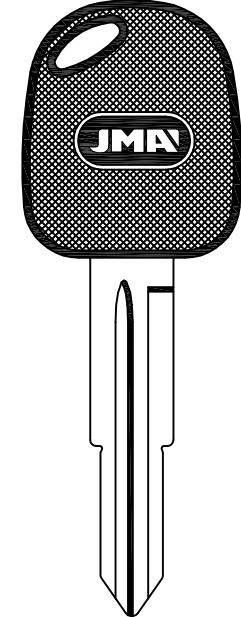

J....  
1-1200  
DAE-3.P2  
DAE-3D.P2  
FOR: DAEWOO®

FOR: G.M. (CADILLAC)®

FOR: G.M. (CHEVROLET)®

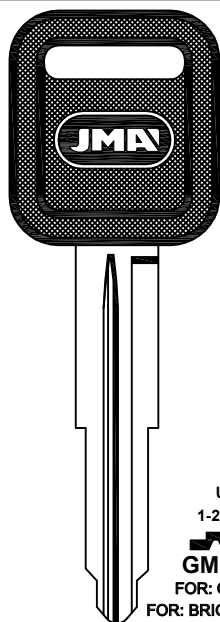

A  
000-999  
GM-6  
E  
000-999  
GM-8  
U  
1-2000  
GM-3.P  
FOR: G.M.®  
FOR: BRIGGS S.®

FOR: G.M.®  
FOR: BRIGGS STRATTON®

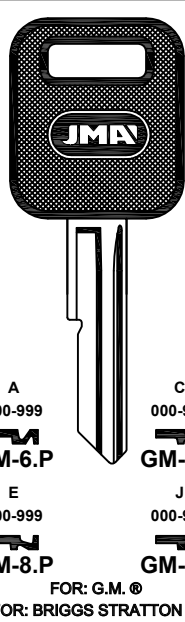

C  
000-999  
GM-7  
J  
000-999  
GM-9  
E  
000-999  
GM-8.P  
J  
000-999  
GM-9.P  
FOR: G.M.®  
FOR: BRIGGS STRATTON®

FOR: G.M.®  
FOR: BRIGGS STRATTON®

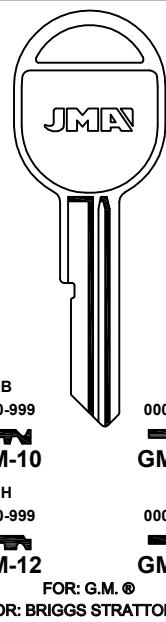

B  
000-999  
GM-10  
H  
000-999  
GM-12  
D  
000-999  
GM-11  
K  
000-999  
GM-13  
FOR: G.M.®  
FOR: BRIGGS STRATTON®

FOR: G.M.®  
FOR: BRIGGS STRATTON®

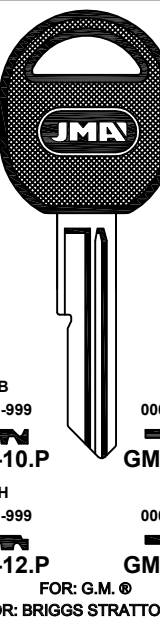

B  
000-999  
GM-10.P  
H  
000-999  
GM-12.P  
D  
000-999  
GM-11.P  
K  
000-999  
GM-13.P  
FOR: G.M.®  
FOR: BRIGGS STRATTON®

FOR: G.M.®  
FOR: BRIGGS STRATTON®

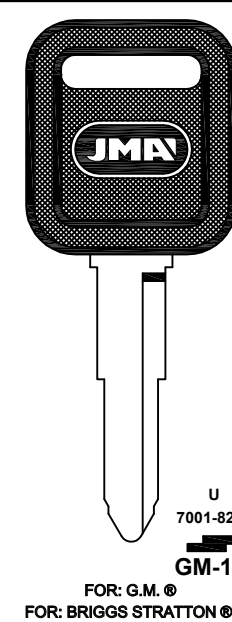

U  
7001-8200  
GM-1.P  
FOR: G.M.®  
FOR: BRIGGS STRATTON®

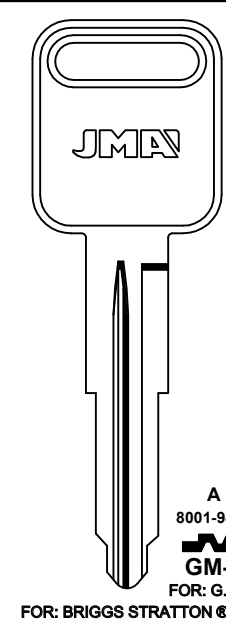

A  
8001-9400  
GM-2  
FOR: G.M.®  
FOR: BRIGGS STRATTON®

FOR: BRIGGS STRATTON®

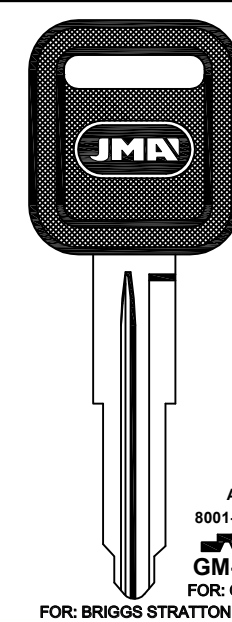

A  
8001-9400  
GM-2.P  
FOR: G.M.®  
FOR: BRIGGS STRATTON®

FOR: BRIGGS STRATTON®

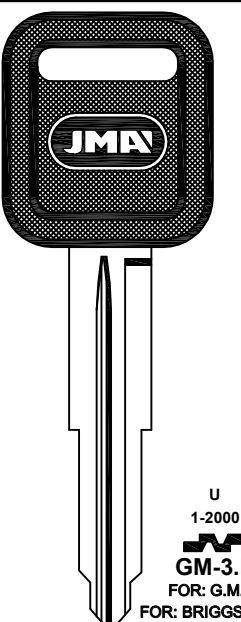

U  
1-2000  
GM-3.P  
FOR: G.M.®  
FOR: BRIGGS S.®

FOR: BRIGGS STRATTON®

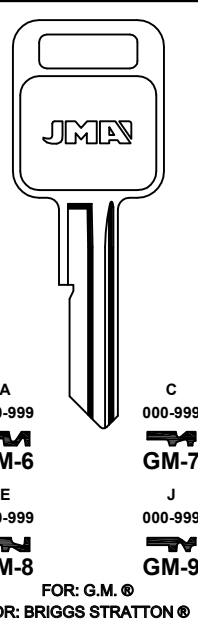

A  
000-999  
GM-8  
E  
000-999  
GM-8  
J  
000-999  
GM-9  
FOR: G.M.®  
FOR: BRIGGS STRATTON®

FOR: G.M.®  
FOR: BRIGGS STRATTON®

FOR: G.M. (CADILLAC)®

FOR: G.M. (CHEVROLET)®

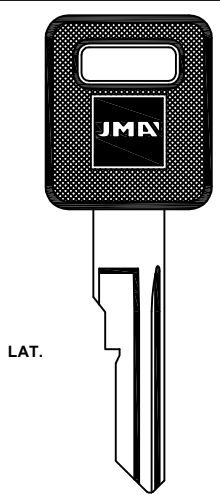

A  
..A.00.0-99.9  
..B.00.0-99.9  
..V.00.0-99.9  
..V.00.0-99.9  
..W.00.0-99.9  
..W.00.0-99.9  
C  
..A.00.0-99.9  
..B.00.0-99.9  
..N.00.0-99.9  
..N.00.0-99.9  
..P.00.0-99.9  
..P.00.0-99.9  
GM-16.P  
GM-17.P  
FOR: G.M.®  
FOR: BRIGGS STRATTON®

E  
..J.00.0-99.9  
..K.00.0-99.9  
GM-18.P  
FOR: G.M.®  
FOR: BRIGGS STRATTON®

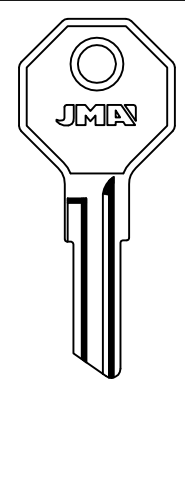

GM-26  
FOR: G.M.®

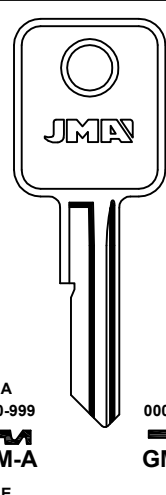

A  
000-999  
GM-A  
E  
000-999  
GM-E  
C  
000-999  
GM-C  
J  
000-999  
GM-J  
FOR: G.M.®  
FOR: BRIGGS STRATTON®

FOR: G.M.®  
FOR: BRIGGS STRATTON®

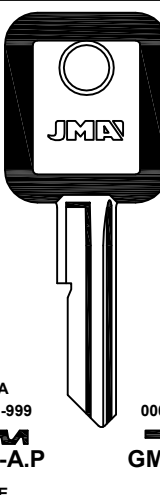

A  
000-999  
GM-A.P  
E  
000-999  
GM-E.P  
C  
000-999  
GM-C.P  
J  
000-999  
GM-J.P  
FOR: G.M.®  
FOR: BRIGGS STRATTON®

FOR: G.M.®  
FOR: BRIGGS STRATTON®

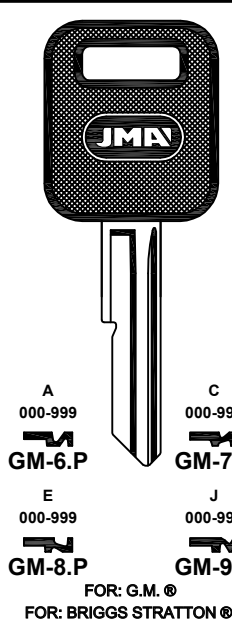

A  
000-999  
GM-6.P  
E  
000-999  
GM-8.P  
C  
000-999  
GM-7.P  
J  
000-999  
GM-9.P  
FOR: G.M.®  
FOR: BRIGGS STRATTON®

FOR: BRIGGS STRATTON®

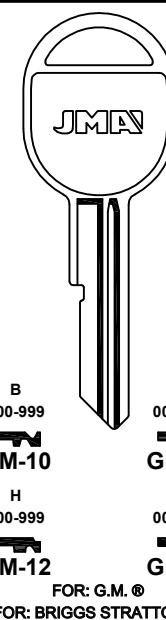

B  
000-999  
GM-10  
H  
000-999  
GM-12  
D  
000-999  
GM-11  
K  
000-999  
GM-13  
FOR: G.M.®  
FOR: BRIGGS STRATTON®

FOR: BRIGGS STRATTON®

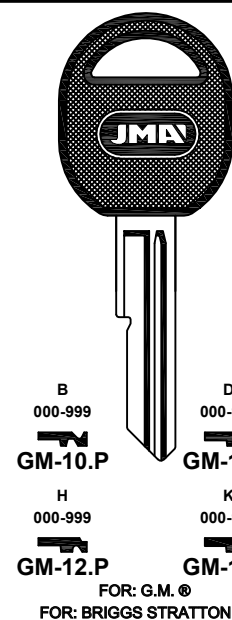

B  
000-999  
GM-10.P  
H  
000-999  
GM-12.P  
D  
000-999  
GM-11.P  
K  
000-999  
GM-13.P  
FOR: G.M.®  
FOR: BRIGGS STRATTON®

FOR: BRIGGS STRATTON®

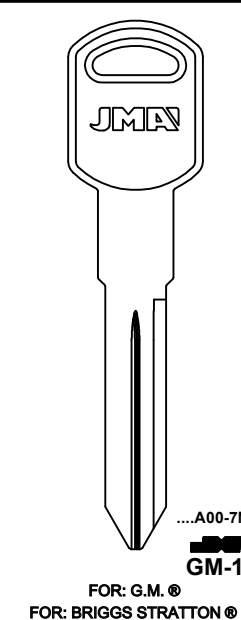

...A00-7N45  
GM-14  
FOR: G.M.®  
FOR: BRIGGS STRATTON®

FOR: BRIGGS STRATTON®

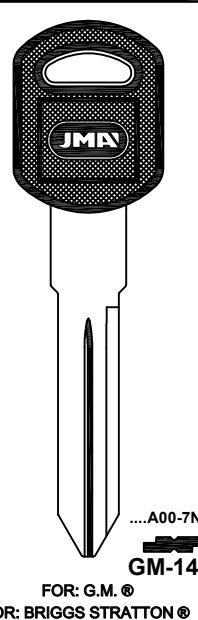





...A00-7N45  
GM-14.P  
FOR: G.M.®  
FOR: BRIGGS STRATTON®

FOR: BRIGGS STRATTON®

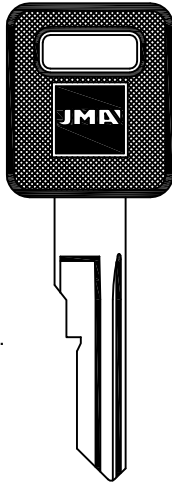
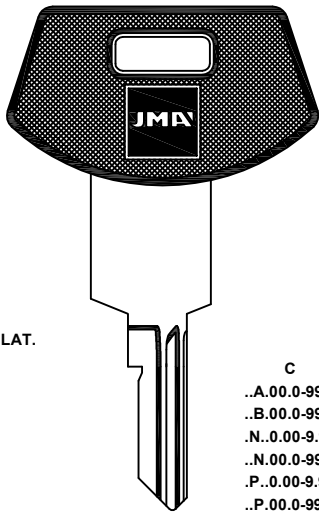
Concerning the marks and commercial denominations see legal warning.  
Concerniente a las marcas y denominaciones comerciales ver aviso legal.  
Marka eta izendapen komertzialiei dagokienez, ikus lege-oharra.  
Concernant les marques et denominations commerciales voir la note dans l'index.

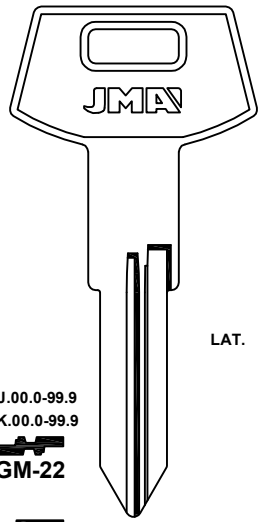
FOR: G.M. (CHEVROLET)®

 <p>LAT.</p> <p>A ..A.00-99.9 ..B.00-99.9 ..V.00-99.9 ..W.00-99.9 ..J.00-99.9 ..K.00-99.9</p> <p><b>GM-16.P</b> FOR: G.M.® FOR: BRIGGS STRATTON®</p>	<p>C ..A.00-99.9 ..B.00-99.9 ..N.00-99.9 ..P.00-99.9</p> <p><b>GM-17.P</b> FOR: G.M.® FOR: BRIGGS STRATTON®</p>	 <p>LAT.</p> <p>C ..A.00-99.9 ..B.00-99.9 ..N.00-99.9 ..P.00-99.9</p> <p><b>GM-19.P</b> FOR: G.M.® FOR: BRIGGS STRATTON®</p>	 <p>E ..J.00-99.9 ..K.00-99.9</p> <p><b>GM-20.P</b> FOR: G.M.® FOR: BRIGGS STRATTON®</p>	 <p>LAT.</p> <p>..J.00-99.9 ..K.00-99.9</p> <p><b>GM-22</b> FOR: G.M.® FOR: BRIGGS STRATTON®</p>	 <p><b>GM-23</b> FOR: G.M.® FOR: BRIGGS STRATTON®</p>
--	---	---	--	---	--

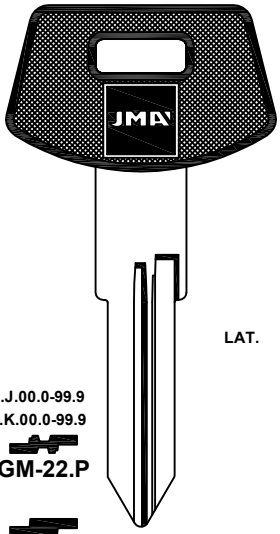
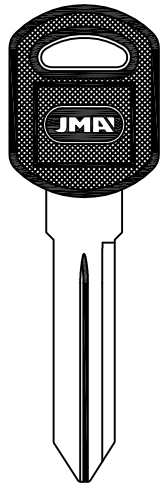
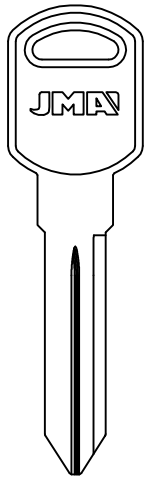
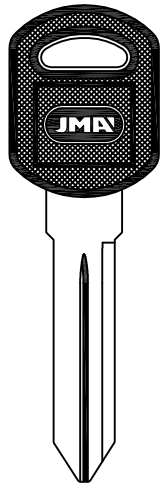
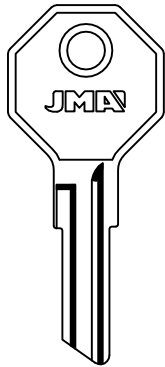

FOR: G.M. (CHEVROLET)®

 <p>LAT.</p> <p>..J.00-99.9 ..K.00-99.9</p> <p><b>GM-22.P</b> FOR: G.M.® FOR: BRIGGS STRATTON®</p>	 <p>LAT.</p> <p>..A00-7N45</p> <p><b>GM-23.P</b> FOR: G.M.® FOR: BRIGGS STRATTON®</p>	 <p>LAT.</p> <p>..A00-7N45</p> <p><b>GM-25</b> FOR: G.M.® FOR: BRIGGS STRATTON®</p>	 <p>LAT.</p> <p>..A00-7N45</p> <p><b>GM-25.P</b> FOR: G.M.® FOR: BRIGGS STRATTON®</p>	 <p>LAT.</p> <p><b>GM-26</b> FOR: G.M.® FOR: BRIGGS STRATTON®</p>	<p>A 000-999</p> <p><b>GM-A</b> FOR: G.M.® FOR: BRIGGS STRATTON®</p>	<p>C 000-999</p> <p><b>GM-C</b> FOR: G.M.® FOR: BRIGGS STRATTON®</p>	<p>E 000-999</p> <p><b>GM-E</b> FOR: G.M.® FOR: BRIGGS STRATTON®</p>	<p>J 000-999</p> <p><b>GM-J</b> FOR: G.M.® FOR: BRIGGS STRATTON®</p>
---	---	---	---	--	--	--	--	--

FOR: G.M. (CHEVROLET)®

<p>A 000-999</p> <p><b>GM-A.P</b> FOR: G.M.® FOR: BRIGGS STRATTON®</p>	<p>C 000-999</p> <p><b>GM-C.P</b> FOR: G.M.® FOR: BRIGGS STRATTON®</p>	<p>B 000-999</p> <p><b>GM-B</b> FOR: G.M.® FOR: BRIGGS STRATTON®</p>	<p>D 000-999</p> <p><b>GM-D</b> FOR: G.M.® FOR: BRIGGS STRATTON®</p>	<p>B 000-999</p> <p><b>GM-B.P</b> FOR: G.M.® FOR: BRIGGS STRATTON®</p>	<p>D 000-999</p> <p><b>GM-D.P</b> FOR: G.M.® FOR: BRIGGS STRATTON®</p>	<p>H 001-400 2221-2620 4441-4640 4641-5143</p> <p><b>MIT-21</b> FOR: MITSUBISHI®</p>	<p>E 2001-3000</p> <p><b>MIT-2D</b> FOR: MITSUBISHI®</p>	<p>1... 1-5000</p> <p><b>TOYO-15</b> FOR: TOYOTA® FOR: TOKAJ®-RIKA®</p>
--	--	--	--	--	--	--	--	---

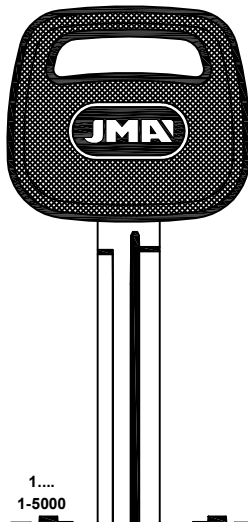
FOR: G.M. (CHEVROLET)®

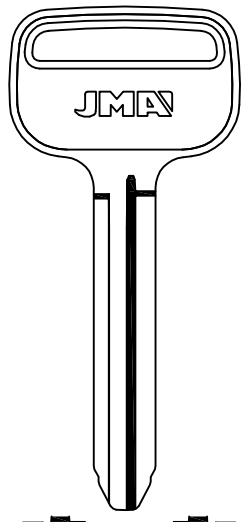
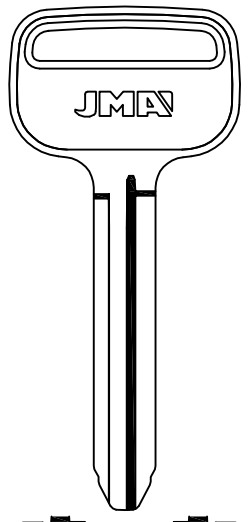
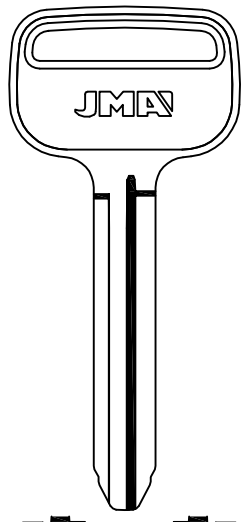
 <p>LAT.</p> <p>1... 1-5000</p> <p><b>TOYO-15.P</b> FOR: TOYOTA® FOR: TOKAJ®-RIKA®</p>	 <p>LAT.</p> <p>2.95 7.8</p> <p><b>TOYO-18.P</b> FOR: TOYOTA® FOR: TOKAJ®-RIKA®</p>	 <p>LAT.</p> <p><b>TOYO-40</b> FOR: TOYOTA®</p>	 <p>LAT.</p> <p><b>TOYO-41.P</b> FOR: TOYOTA®</p>	 <p>LAT.</p> <p><b>TOYO-40D</b> FOR: TOYOTA®</p>
---	--	--	--	---

FOR: G.M. (CHEVROLET BRA.)®

<p>E,D 225-814</p> <p>K 0001-1000</p> <p><b>BAS-11</b> FOR: BASCO® FOR: CORBIN®</p>	<p>CJ 001-500 DP 0001-1400 EP 0001-3000</p> <p><b>CHR-7</b> FOR: CHRYSLER® FOR: YALE®</p>	<p>DP 0001-1400 EP 0001-3000</p> <p><b>CHR-8</b> FOR: CHRYSLER® FOR: YALE®</p>
---	---	--

FOR: G.M. (CHEVROLET BRA.)®

<p>CJ 001-500 DP 0001-1400 EP 0001-3000</p> <p><b>CHR-7.P</b> FOR: CHRYSLER® FOR: YALE®</p>	<p>A 000-999</p> <p><b>GM-6</b> FOR: G.M.® FOR: BRIGGS STRATTON®</p>	<p>C 000-999</p> <p><b>GM-7</b> FOR: G.M.® FOR: BRIGGS STRATTON®</p>	<p>A 000-999</p> <p><b>GM-6.P</b> FOR: G.M.® FOR: BRIGGS STRATTON®</p>	<p>C 000-999</p> <p><b>GM-7.P</b> FOR: G.M.® FOR: BRIGGS STRATTON®</p>	<p>B 000-999</p> <p><b>GM-10</b> FOR: G.M.® FOR: BRIGGS STRATTON®</p>	<p>D 000-999</p> <p><b>GM-11</b> FOR: G.M.® FOR: BRIGGS STRATTON®</p>	<p>B 000-999</p> <p><b>GM-10.P</b> FOR: G.M.® FOR: BRIGGS STRATTON®</p>	<p>D 000-999</p> <p><b>GM-11.P</b> FOR: G.M.® FOR: BRIGGS STRATTON®</p>
---	--	--	--	--	---	---	---	---

FOR: G.M. (CHEVROLET BRA.)®

<p>A 000-999</p> <p><b>GM-A</b> FOR: G.M.® FOR: BRIGGS STRATTON®</p>	<p>C 000-999</p> <p><b>GM-C</b> FOR: G.M.® FOR: BRIGGS STRATTON®</p>	<p>A 000-999</p> <p><b>GM-A.P</b> FOR: G.M.® FOR: BRIGGS STRATTON®</p>	<p>C 000-999</p> <p><b>GM-C.P</b> FOR: G.M.® FOR: BRIGGS STRATTON®</p>	<p>B 000-999</p> <p><b>GM-B</b> FOR: G.M.® FOR: BRIGGS STRATTON®</p>	<p>D 000-999</p> <p><b>GM-D</b> FOR: G.M.® FOR: BRIGGS STRATTON®</p>	<p>B 000-999</p> <p><b>GM-B.P</b> FOR: G.M.® FOR: BRIGGS STRATTON®</p>	<p>D 000-999</p> <p><b>GM-D.P</b> FOR: G.M.® FOR: BRIGGS STRATTON®</p>	<p>D 1-5200</p> <p><b>OP-D</b> FOR: HUF® FOR: YMOS®</p>	<p>S... 1-5200</p> <p><b>OP-S</b> FOR: HUF® FOR: YMOS®</p>
--	--	--	--	--	--	--	--	---	--

Concerning the marks and commercial denominations see legal warning.  
 Concerniente a las marcas y denominaciones comerciales ver aviso legal.  
 Marka eta izendapen komertzialiei dagokienez, ikus lege-oharra.  
 Concernant les marques et dénominations commerciales voir la note dans l'index.

**JMA** Opening the future

**JMA** Opening the future

Beziehen auf die marke und handelsname sehen sie die notiz im Impressum.  
 Relativamente às marcas e denominações comerciais, ver aviso legal.  
 Jeśli chodzi o znaki i nazwy handlowe, patrz Informacje prawne.



FOR: G.M. (CHEVROLET BRA.) ®

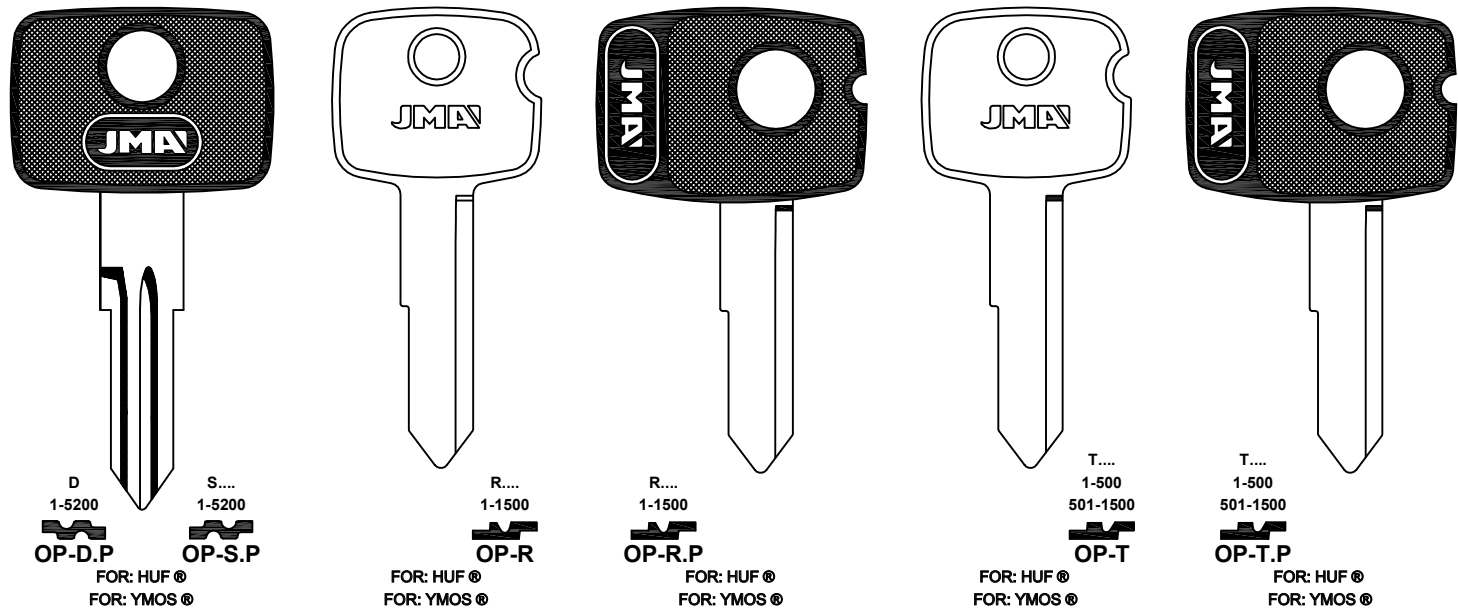

FOR: G.M. (GMC) ®

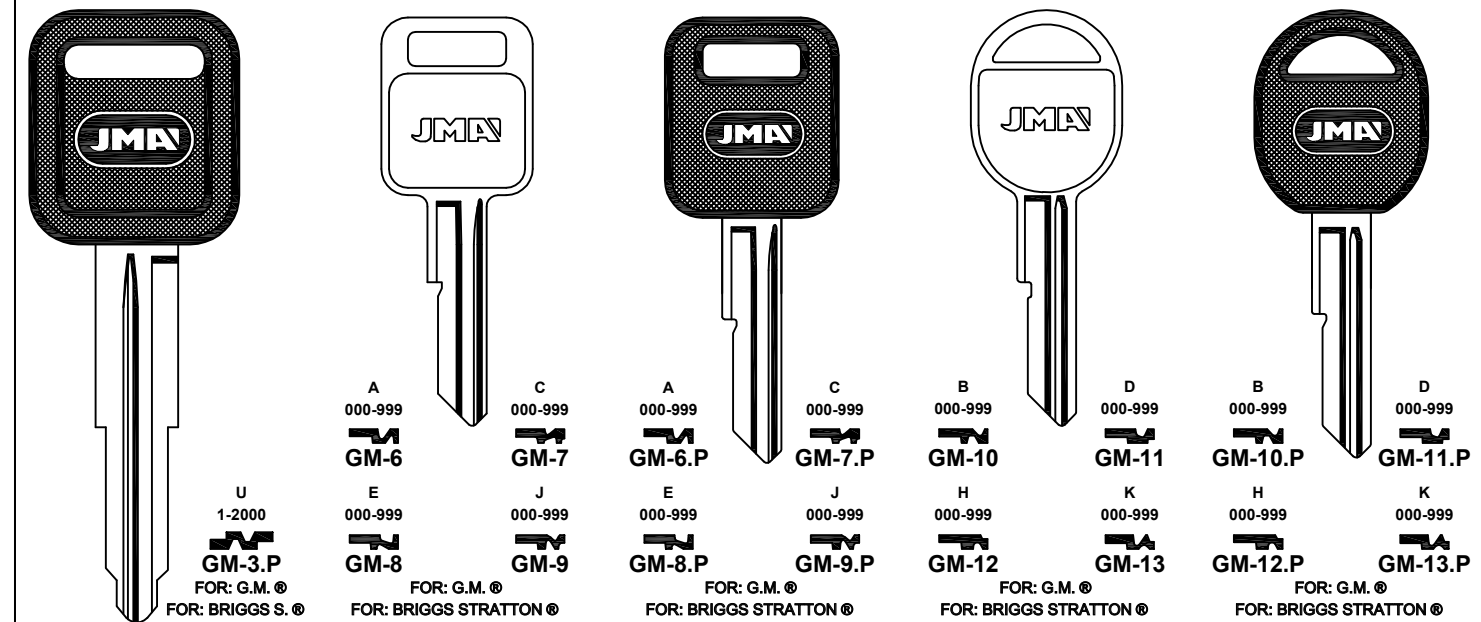

FOR: G.M. (CHEVROLET BRA.) ®

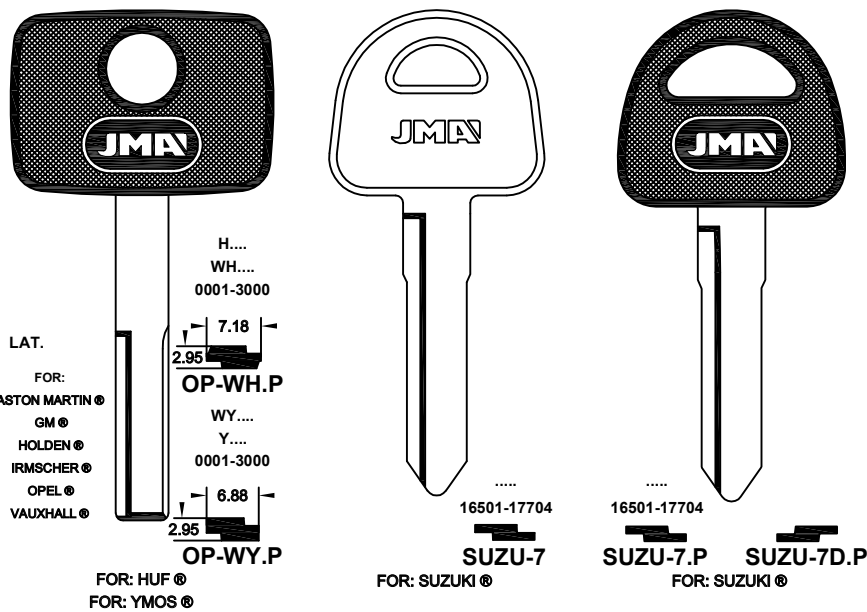

FOR: G.M. (GEO) ®

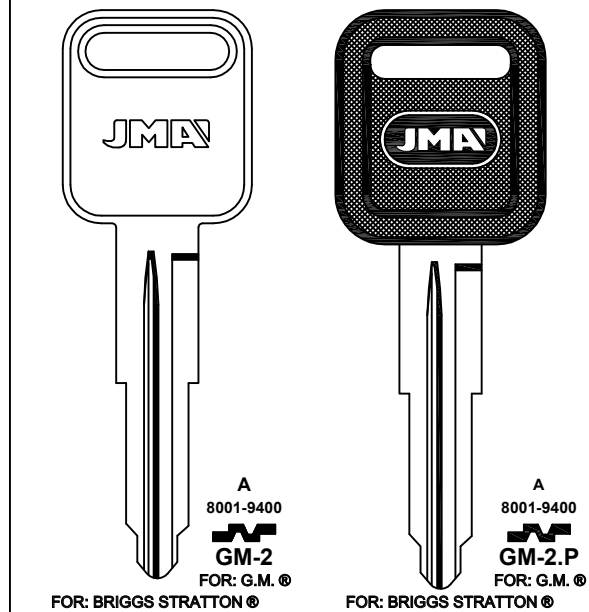

FOR: G.M. (GMC) ®

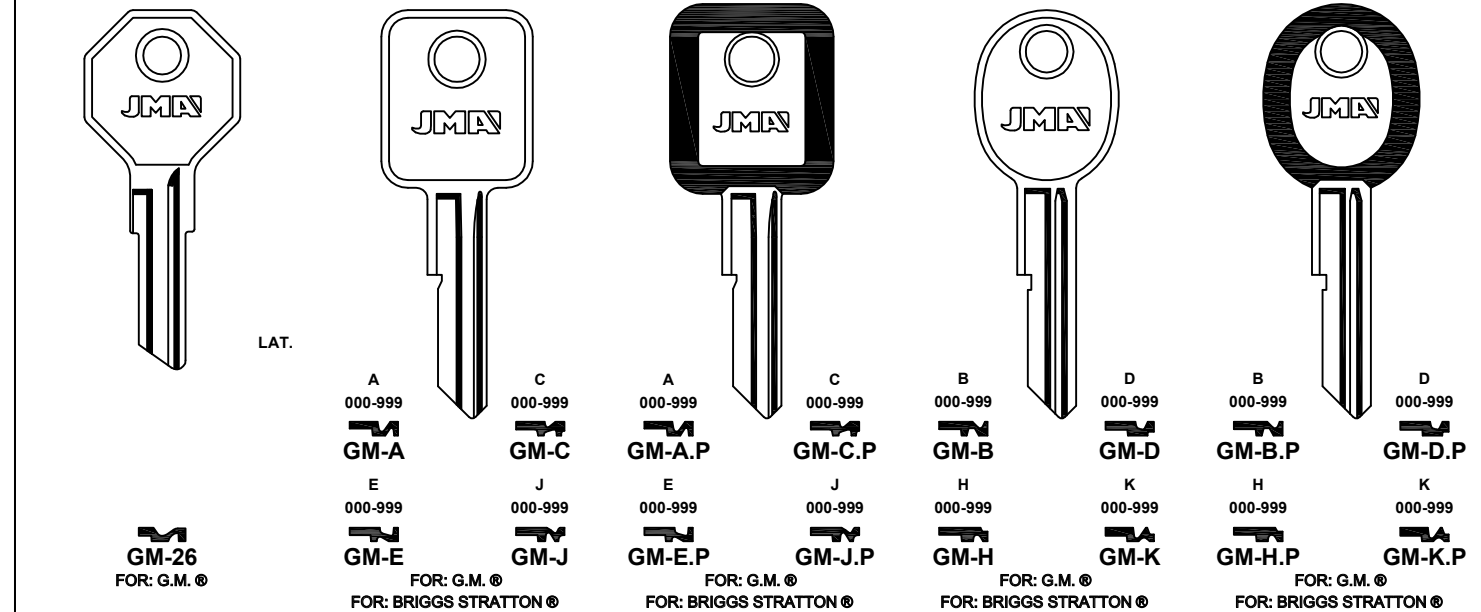

FOR: G.M. (GEO) ®

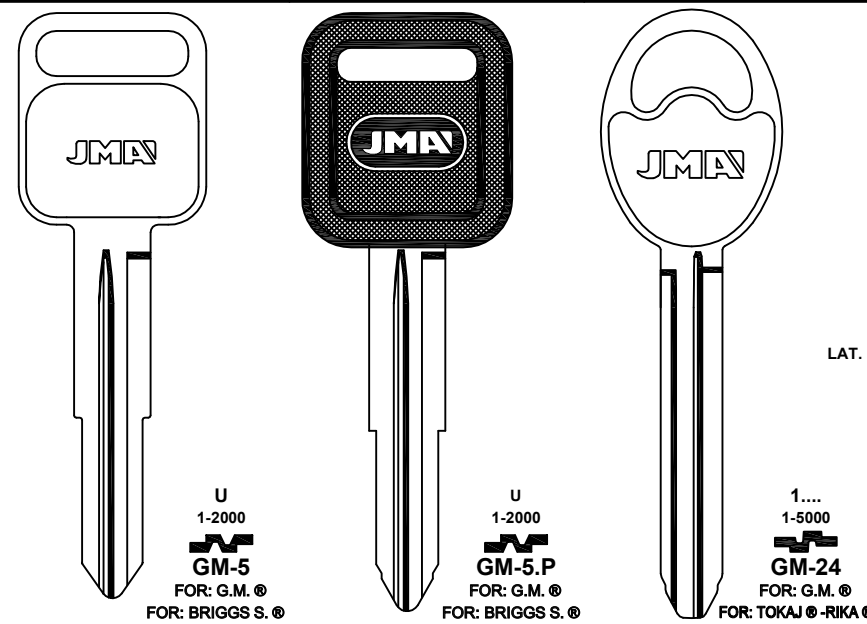

FOR: G.M. (GMC) ®

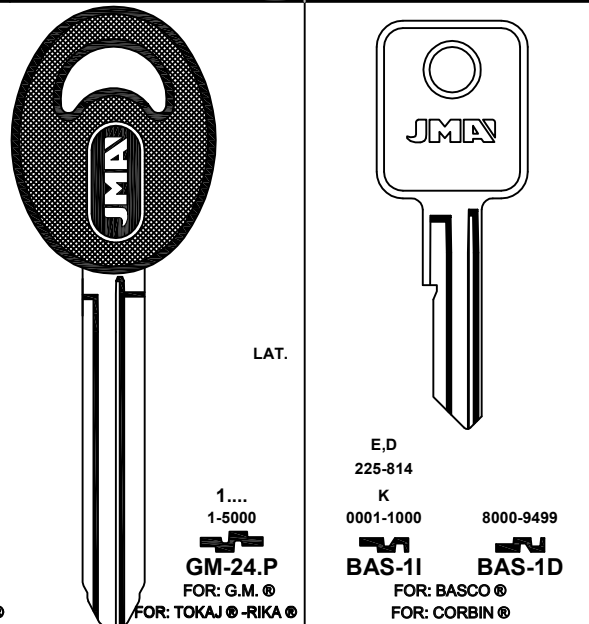

FOR: G.M. (OLDS MOBILE) ®

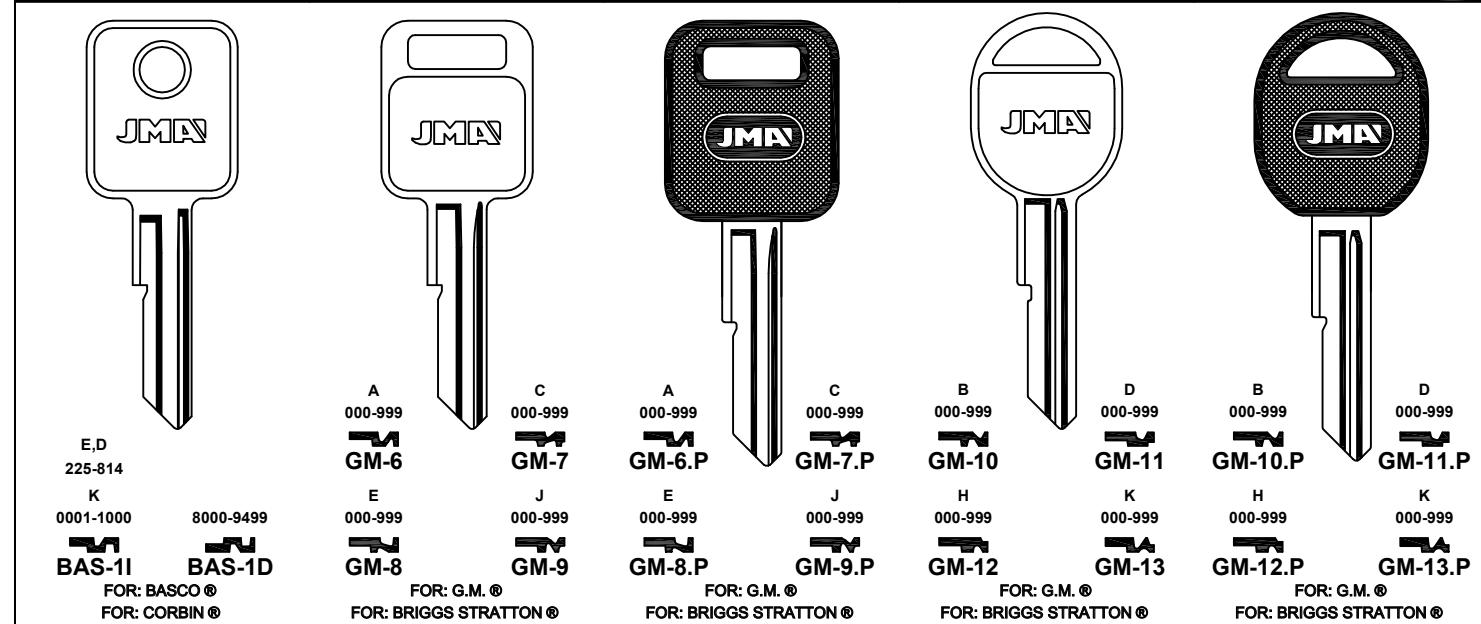

Concerning the marks and commercial denominations see legal warning.  
Concerniente a las marcas y denominaciones comerciales ver aviso legal.  
Marka eta izendapen komertzialiei dagokienez, ikus lege-oharra.  
Concernant les marques et denominations commerciales voir la note dans l'index.

**JMA** Opening the future

**JMA** Opening the future

Beziehen auf die Marke und Handelsname sehen Sie die Notiz im Impressum.  
Relativamente às marcas e denominações comerciais, ver aviso legal.  
Jeśli chodzi o znaki i nazwy handlowe, patrz Informacje prawne.



FOR: G.M. (OLDS MOBILE) ®

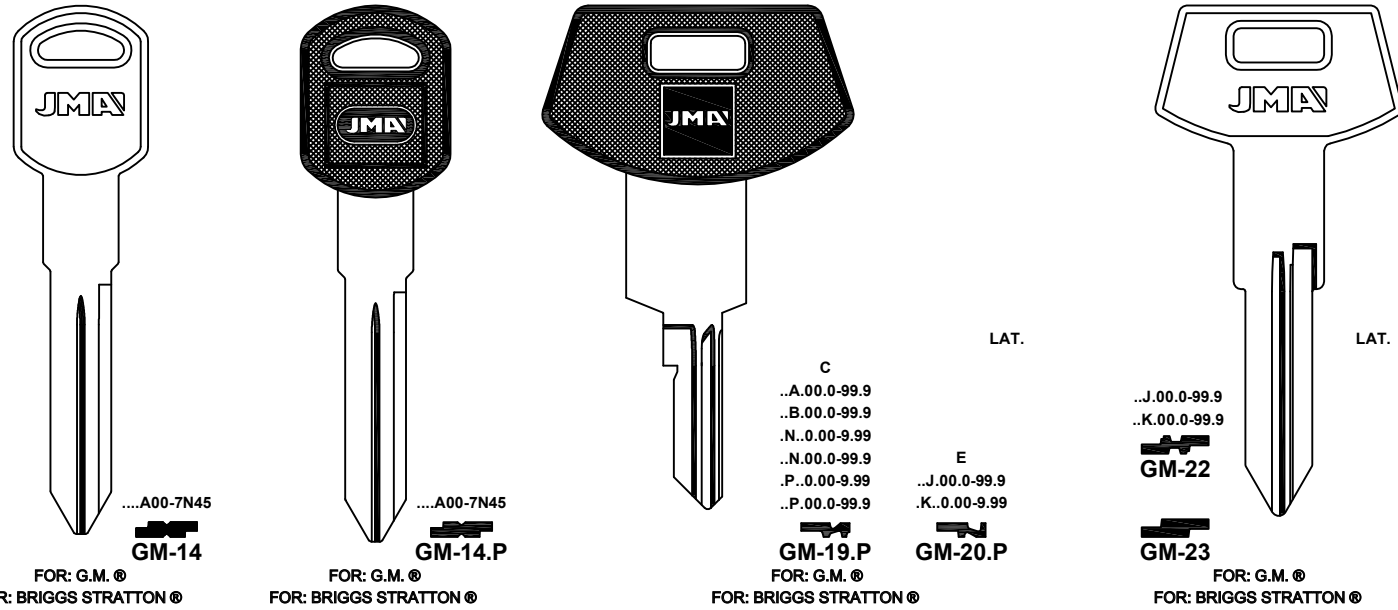

FOR: G.M. (OLDS MOBILE) ®

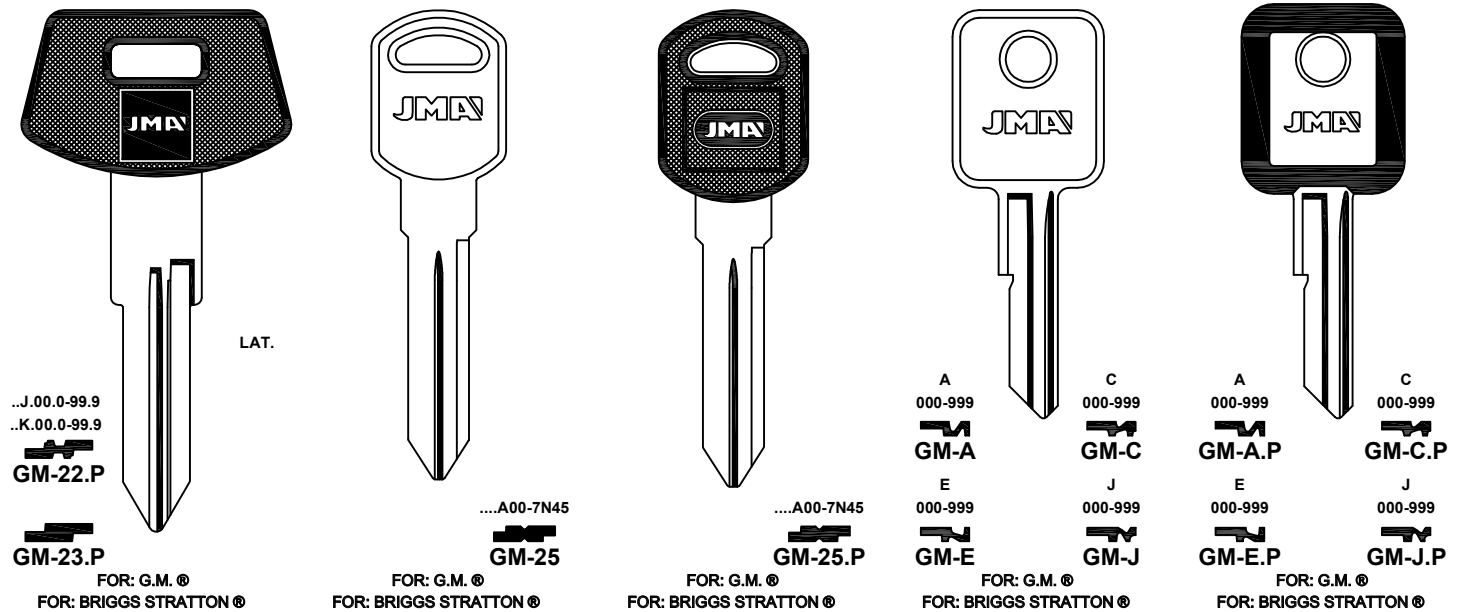

FOR: G.M. (OLDS MOBILE) ®

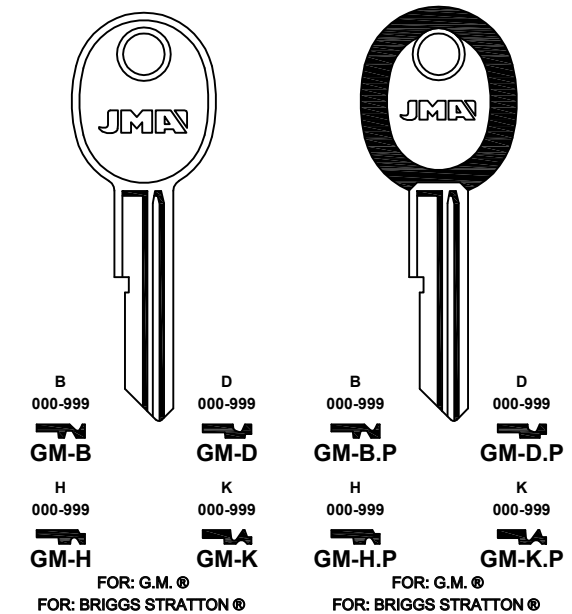

FOR: G.M. (PONTIAC) ®

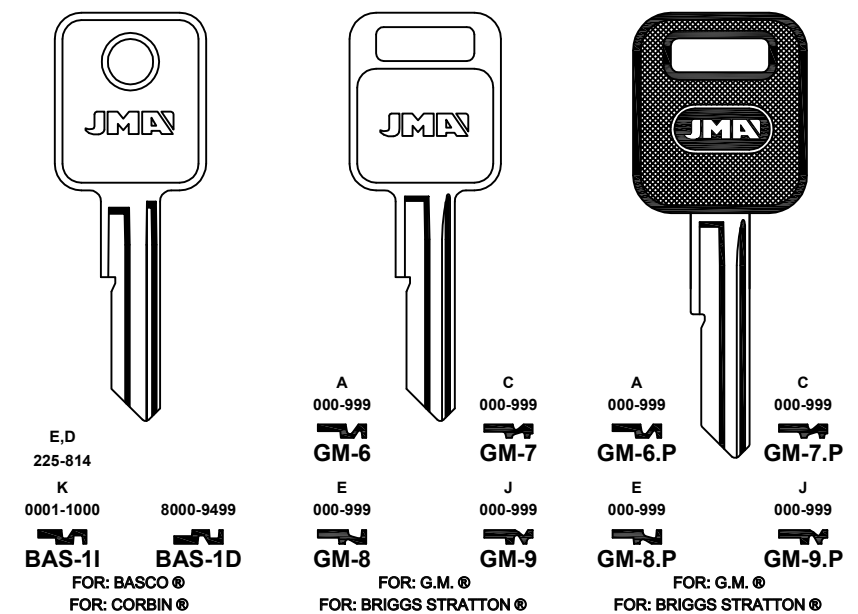

FOR: G.M. (PONTIAC) ®

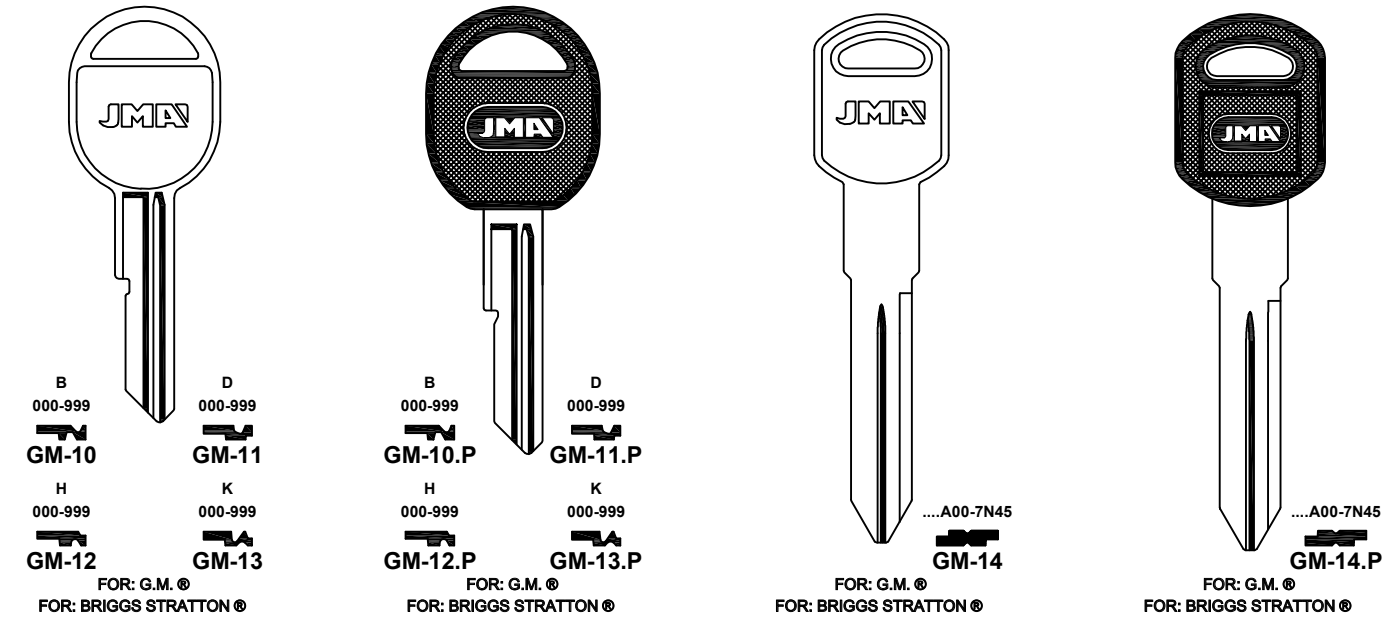

FOR: G.M. (PONTIAC) ®

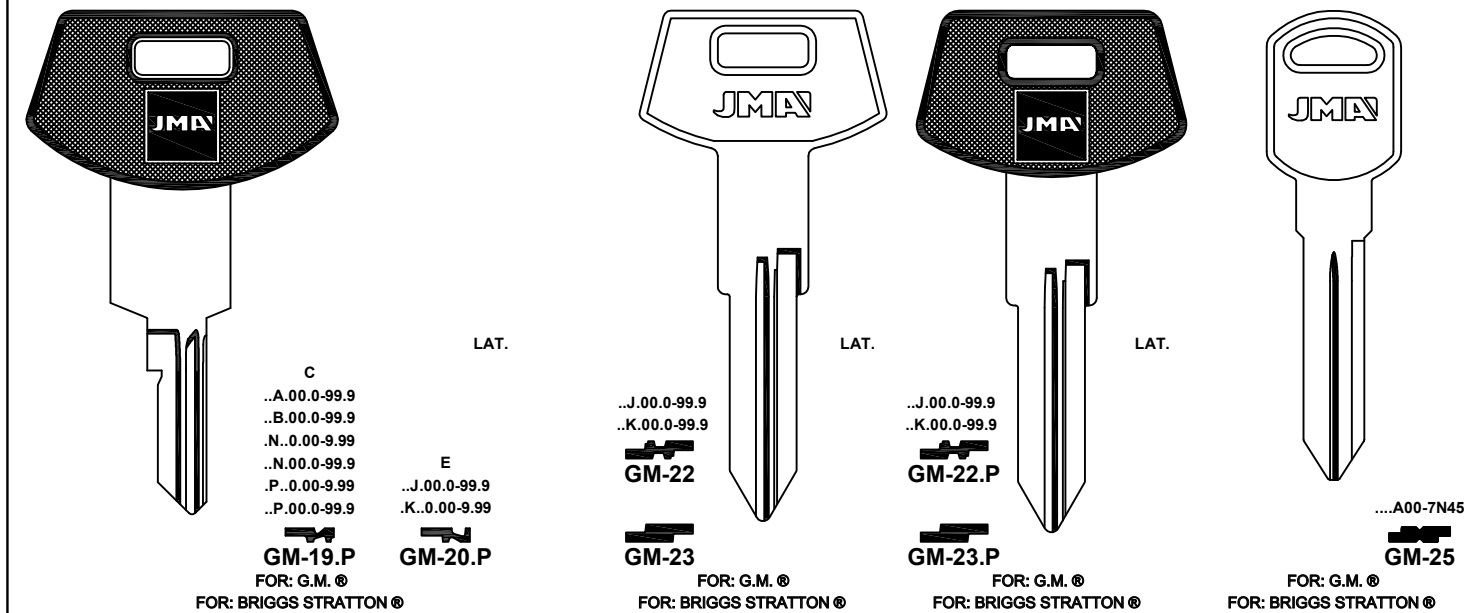

FOR: G.M. (PONTIAC) ®

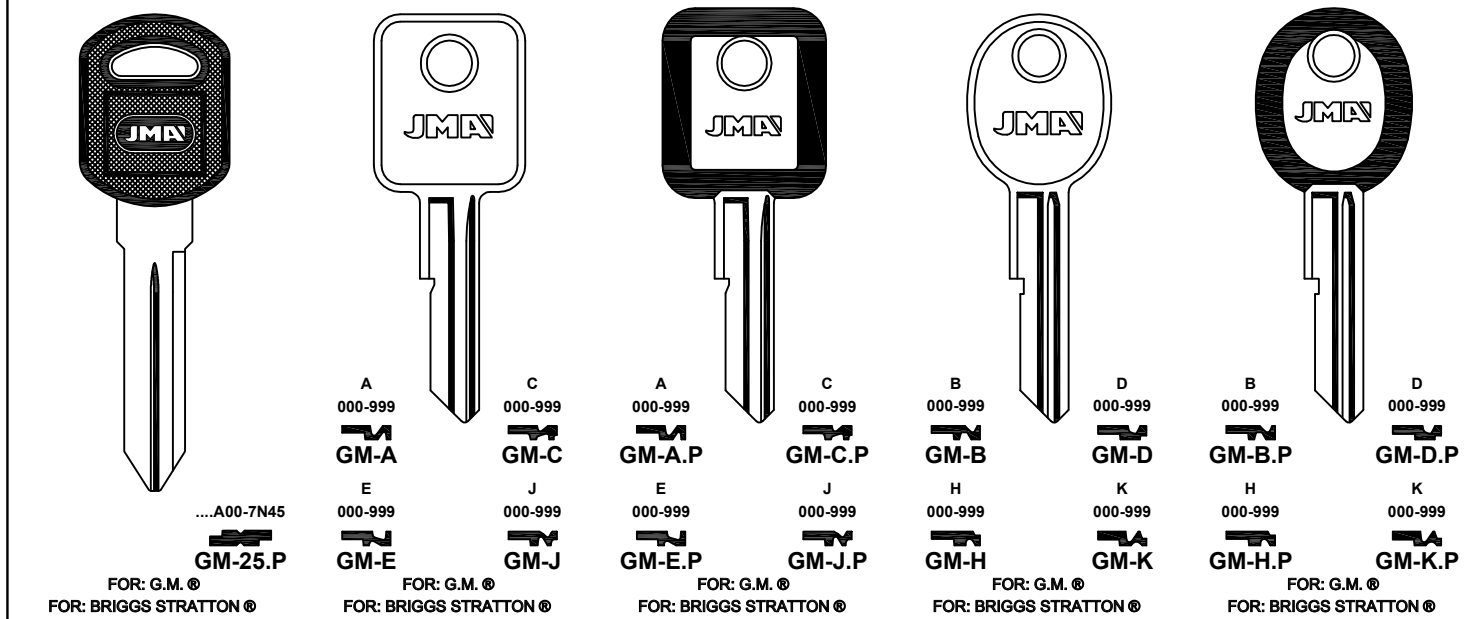

Concerning the marks and commercial denominations see legal warning.  
 Concerniente a las marcas y denominaciones comerciales ver aviso legal.  
 Marka eta izendapen komertzialiei dagokienez, ikus lege-oharra.  
 Concernant les marques et denominations commerciales voir la note dans l'index.

**JMA** Opening the future

**JMA** Opening the future

Beziehen auf die marke und handelsname sehen sie die notiz im Impressum.  
 Relativamente às marcas e denominações comerciais, ver aviso legal.  
 Jeśli chodzi o znaki i nazwy handlowe, patrz Informacje prawne.

**FOR: G.M. (PONTIAC)®**

D 1-5200  
S... 1-5200  
OP-D  
FOR: HUF®  
FOR: YMOS®

D 1-5200  
S... 1-5200  
OP-D.P  
FOR: HUF®  
FOR: YMOS®

**FOR: G.M. (SATURN)®**

R...0-999  
T...0-394  
GM-21  
FOR: G.M.®  
FOR: BRIGGS & STRATTON®

LAT.

R...0-999  
T...0-394  
GM-21.P  
FOR: G.M.®  
FOR: BRIGGS & STRATTON®

LAT.

**FOR: HAMOMAG HENS.®**

VA 01-50  
ME-VA  
FOR: G.M.®  
FOR: CASI®

**FOR: HOLDEN®**

E,D 225-814  
K 0001-1000  
8000-9499  
BAS-11  
FOR: BASCO®  
FOR: CORBIN®

X 0001-9000  
DAT-12  
FOR: NISSAN®

A 8001-9400  
GM-2  
FOR: G.M.®

A 8001-9400  
GM-2.P  
FOR: G.M.®

A 000-999  
GM-6  
FOR: G.M.®

C 000-999  
GM-7  
FOR: G.M.®

E 000-999  
GM-8  
FOR: G.M.®

J 000-999  
GM-9  
FOR: G.M.®

**FOR: HOLDEN®**

A 000-999  
GM-6.P  
FOR: G.M.®  
FOR: BRIGGS STRATTON®

C 000-999  
GM-7.P  
FOR: G.M.®  
FOR: BRIGGS STRATTON®

B 000-999  
GM-10  
FOR: G.M.®  
FOR: BRIGGS STRATTON®

D 000-999  
GM-11  
FOR: G.M.®  
FOR: BRIGGS STRATTON®

B 000-999  
GM-10.P  
FOR: G.M.®  
FOR: BRIGGS STRATTON®

D 000-999  
GM-11.P  
FOR: G.M.®  
FOR: BRIGGS STRATTON®

H 000-999  
GM-12  
FOR: G.M.®  
FOR: BRIGGS STRATTON®

K 000-999  
GM-13  
FOR: G.M.®  
FOR: BRIGGS STRATTON®

H 000-999  
GM-12.P  
FOR: G.M.®  
FOR: BRIGGS STRATTON®

K 000-999  
GM-13.P  
FOR: G.M.®  
FOR: BRIGGS STRATTON®

0000-1999  
GM-42  
FOR: G.M.®

A 000-999  
GM-A  
FOR: G.M.®  
FOR: BRIGGS STRATTON®

C 000-999  
GM-C  
FOR: G.M.®  
FOR: BRIGGS STRATTON®

E 000-999  
GM-E  
FOR: G.M.®  
FOR: BRIGGS STRATTON®

J 000-999  
GM-J  
FOR: G.M.®  
FOR: BRIGGS STRATTON®

**FOR: HOLDEN®**

A 000-999  
GM-A.P  
FOR: G.M.®  
FOR: BRIGGS STRATTON®

C 000-999  
GM-C.P  
FOR: G.M.®  
FOR: BRIGGS STRATTON®

B 000-999  
GM-B  
FOR: G.M.®  
FOR: BRIGGS STRATTON®

D 000-999  
GM-D  
FOR: G.M.®  
FOR: BRIGGS STRATTON®

B 000-999  
GM-B.P  
FOR: G.M.®  
FOR: BRIGGS STRATTON®

D 000-999  
GM-D.P  
FOR: G.M.®  
FOR: BRIGGS STRATTON®

E 000-999  
GM-E.P  
FOR: G.M.®  
FOR: BRIGGS STRATTON®

J 000-999  
GM-J.P  
FOR: G.M.®  
FOR: BRIGGS STRATTON®

H 000-999  
GM-H  
FOR: G.M.®  
FOR: BRIGGS STRATTON®

K 000-999  
GM-K  
FOR: G.M.®  
FOR: BRIGGS STRATTON®

H 000-999  
GM-H.P  
FOR: G.M.®  
FOR: BRIGGS STRATTON®

K 000-999  
GM-K.P  
FOR: G.M.®  
FOR: BRIGGS STRATTON®

A...201-1050  
C...500-699  
H...601-1100  
HM...201-1050  
HUD-1  
FOR: HUDSON®

H 001-400  
2221-2620  
4441-4640  
4641-5143  
E 2001-3000  
MIT-1I  
FOR: MITSUBISHI®

H 001-400  
2221-2620  
4441-4640  
4641-5143  
E 2001-3000  
MIT-1D  
FOR: MITSUBISHI®

**FOR: HOLDEN®**

H 001-400  
2221-2620  
4441-4640  
4641-5143  
E 2001-3000  
MIT-1I.P  
FOR: MITSUBISHI®

H 001-400  
2221-2620  
4441-4640  
4641-5143  
E 2001-3000  
MIT-1D.P  
FOR: MITSUBISHI®

AB... 1-1000  
OP-AB  
FOR: HUF®  
FOR: YMOS®

BA... 1-1000  
OP-BA  
FOR: HUF®  
FOR: YMOS®

AB... 1-1000  
OP-AB.P  
FOR: HUF®  
FOR: YMOS®

BA... 1-1000  
OP-BA.P  
FOR: HUF®  
FOR: YMOS®

D 1-5200  
OP-D  
FOR: HUF®  
FOR: YMOS®

S... 1-5200  
OP-S  
FOR: HUF®  
FOR: YMOS®

D 1-5200  
OP-D.P  
FOR: HUF®  
FOR: YMOS®

S... 1-5200  
OP-S.P  
FOR: HUF®  
FOR: YMOS®

**FOR: HOLDEN®**

J... 1-2874  
OP-J  
FOR: HUF®  
FOR: YMOS®

J... 1-2874  
OP-J.P  
FOR: HUF®  
FOR: YMOS®

H... WH... 0001-3000  
OP-WH.P  
FOR: ASTON MARTIN®  
GM®  
HOLDEN®  
IRMSCHER®  
OPEL®  
VAUXHALL®

WY... Y... 0001-3000  
OP-WY.P  
FOR: HUF®  
FOR: YMOS®

U... 1-2000  
SUZU-10  
FOR: SUZUKI®

U... 1-2000  
SUZU-10.P  
FOR: SUZUKI®

Concerning the marks and commercial denominations see legal warning.  
 Concerniente a las marcas y denominaciones comerciales ver aviso legal.  
 Marka eta izendapen komertzialiei dagokienez, ikus lege-oharra.  
 Concernant les marques et denominations commerciales voir la note dans l'index.

**JMA®** Opening the future

**JMA®** Opening the future

Beziehen auf die Marke und Handelsname sehen sie die Notiz im Impressum.  
 Relativamente às marcas e denominações comerciais, ver aviso legal.  
 Jeśli chodzi o znaki i nazwy handlowe, patrz Informacje prawne.

FOR: HONDA®

**K...**  
001-400/1511-1910  
2221-2620/3731-4570  
5001-6368

**R...**  
401-800/1112-1510  
2621-3020/3331-3730  
5001-6924/8001-9368

**S...**  
5951-6350/7061-7460  
8171-8570/9281-9680

**D...**  
6001-7042

**TOYO-K1**  
FOR: TOYOTA®  
FOR: TOKAJ® -RIKA®

**F...**  
5951-6350  
7061-7460  
8171-8570  
9281-9680

**P...**  
7001-8500

**TOYO-4**

**C...**  
6001-7042

**TOYO-14**

**K...**  
001-400/1511-1910  
2221-2620/3731-4570  
5001-6368

**R...**  
401-800/1112-1510  
2621-3020/3331-3730  
5001-6924/8001-9368

**S...**  
5951-6350/7061-7460  
8171-8570/9281-9680

**D...**  
6001-7042

**TOYO-K1.P**  
FOR: TOYOTA®  
FOR: TOKAJ® -RIKA®

**F...**  
5951-6350  
7061-7460  
8171-8570  
9281-9680

**P...**  
7001-8500

**TOYO-4.P**

**C...**  
6001-7042

**TOYO-14.P**

**FK...**  
01-99  
876-955

**UN-FK**  
FOR: UNION®  
FOR: WBH®

**FS...**  
01-99  
876-955

**UN-FS**

FOR: HONDA®

**U**  
1-2000  
**GM-5.P**  
FOR: G.M.®  
FOR: BRIGGS S.®

**001-700**  
**HOND-1**  
FOR: HONDA®

**001-700**  
**HOND-2**  
FOR: HONDA®

**001-700**  
**HOND-2.P**  
FOR: HONDA®

**1 AL 4**  
**HOND-3I** **HOND-3D**  
FOR: HONDA®

**3001-4481**  
**HOND-10**  
FOR: HONDA®

**3001-4481**  
**HOND-11**  
FOR: HONDA®

FOR: HONDA®

**3001-4481**  
**HOND-10.P**  
FOR: HONDA®

**3001-4481**  
**HOND-11.P**  
FOR: HONDA®

**1...**  
001-700  
**HOND-12**  
FOR: HONDA®

**2...**  
001-700  
**HOND-13**  
FOR: HONDA®

**1...**  
001-700  
**HOND-12.P**  
FOR: HONDA®

**2...**  
001-700  
**HOND-13.P**  
FOR: HONDA®

**5001-8442**  
**HOND-14**  
FOR: HONDA®

**5001-8442**  
**HOND-14.P**  
FOR: HONDA®

FOR: HONDA®

**5001-8442**  
**HOND-15**  
FOR: HONDA®

**5001-8442**  
**HOND-15.P**  
FOR: HONDA®

**5001-8442**  
**HOND-16**  
FOR: HONDA®

**5001-8442**  
**HOND-16D**  
FOR: HONDA®

**...2001-4949**  
**GM**  
**...2001-3000**  
**NE-1**  
FOR: NEIMAN®  
FOR: CLAUSOR®

**...2001-4949**  
**GM**  
**...2001-3000**  
**NE-1D**  
FOR: NEIMAN®  
FOR: CLAUSOR®

FOR: AUDI®  
FOR: HONDA®  
FOR: MG®  
FOR: ROVER®  
FOR: BEDFORD®  
FOR: FIAT/VECO®  
FOR: VOLVO®

FOR: HONDA®

**...2001-4949**  
**GM**  
**...2001-3000**  
**NE-1.P**  
FOR: NEIMAN®  
FOR: CLAUSOR®

**FOR:**  
AUDI®  
HONDA®  
MG®  
ROVER®  
BEDFORD®  
FIAT/VECO®  
VOLVO®

**R...**  
**E...**  
4001-5000  
**S...**  
8001-10000  
**NE-1D.P**  
FOR: NEIMAN®

**R...**  
**E...**  
4001-5000  
**S...**  
8001-10000  
**NE-35**  
FOR: NEIMAN®

FOR: HUMMER®

**A...**  
101-125  
501-598  
701-790  
**BL-2**

**B...**  
201-225  
**BL-3**

**A**  
**BL-4**

**B**  
**BL-4D**

**A 201-225** **B 101-125**  
**BL-6** **BL-6D**

**FOR: BLAU®**  
**FOR: FORT® -HK® -WASO®**

**RE-1** **RE-1D**  
**FOR: RENZ®**  
**FOR: ARFE®**

FOR: HYUNDAI®

**A/Z... 0111-0333**  
**HY-1**  
FOR: HYUNDAI®

**Y**  
1001-2000  
**HY-2**  
FOR: HYUNDAI®

**Y**  
1001-2000  
**HY-2.P**  
FOR: HYUNDAI®

**Y**  
1001-2000  
**HY-3**  
FOR: HYUNDAI®

**X**  
1001-2000  
**HY-3D**  
FOR: HYUNDAI®

Concerning the marks and commercial denominations see legal warning.  
Concerniente a las marcas y denominaciones comerciales ver aviso legal.  
Marka eta izendapen komertzialiei dagokienez, ikus lege-oharra.  
Concernant les marques et denominations commerciales voir la note dans l'index.

**JMA** Opening the future

**JMA** Opening the future

Beziehen auf die marke und handelsname sehen sie die notiz im Impressum.  
Relativamente às marcas e denominações comerciais, ver aviso legal.  
Jeśli chodzi o znaki i nazwy handlowe, patrz Informacje prawne.



FOR: HYUNDAI®

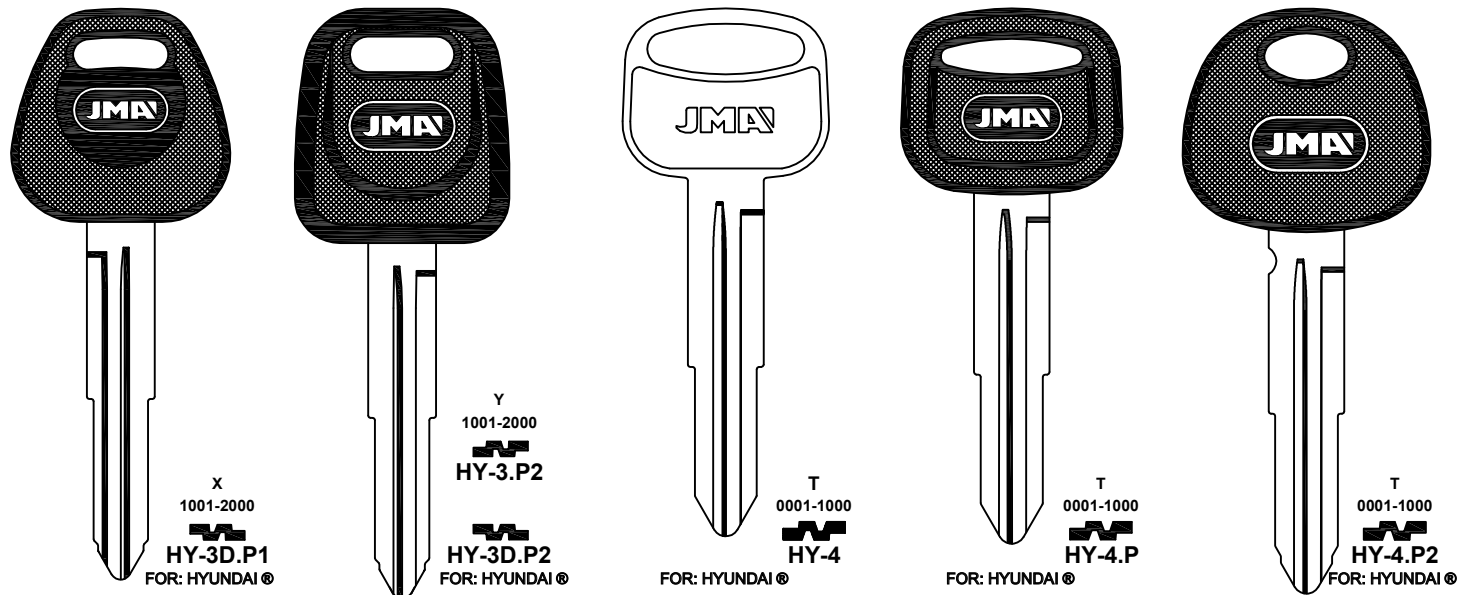

FOR: HYUNDAI®

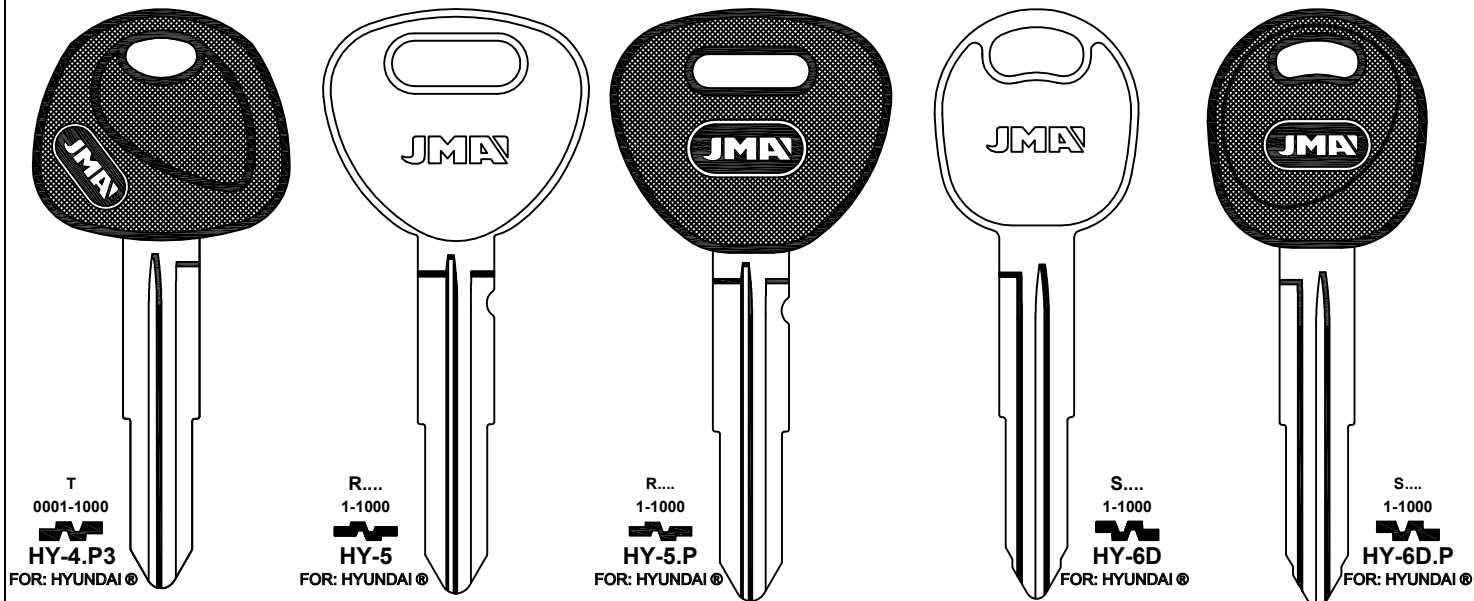

FOR: HYUNDAI®

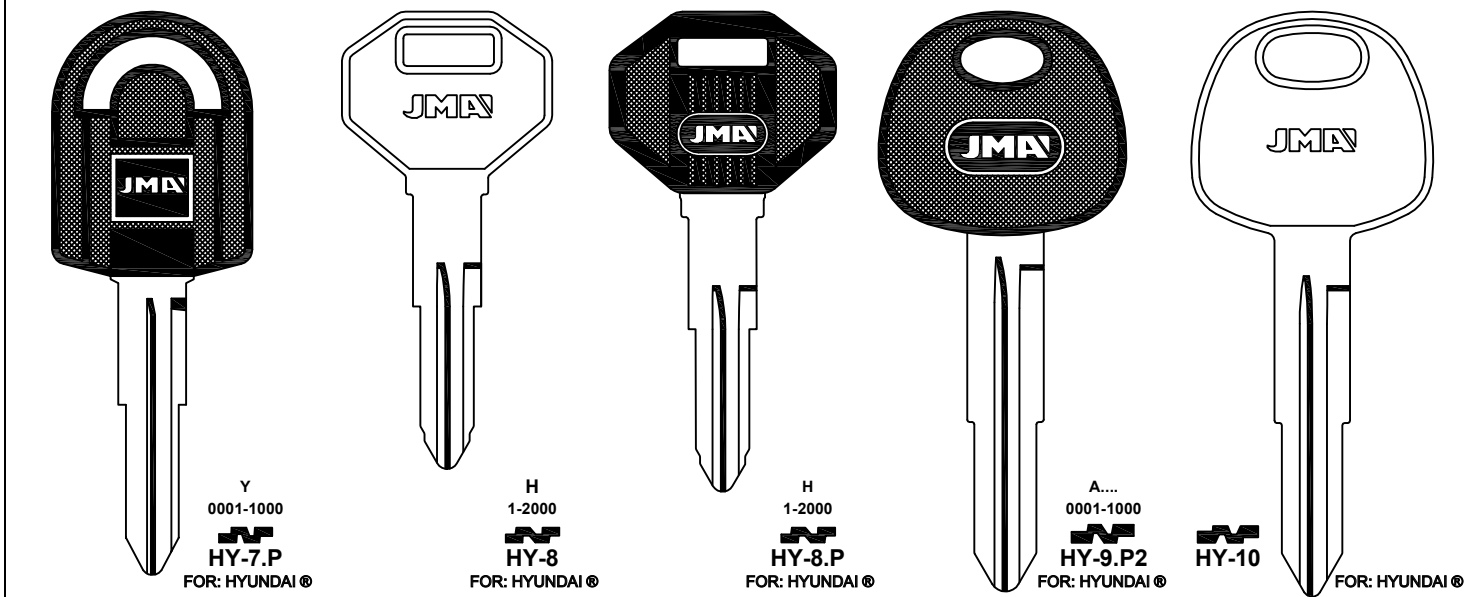

FOR: HYUNDAI®

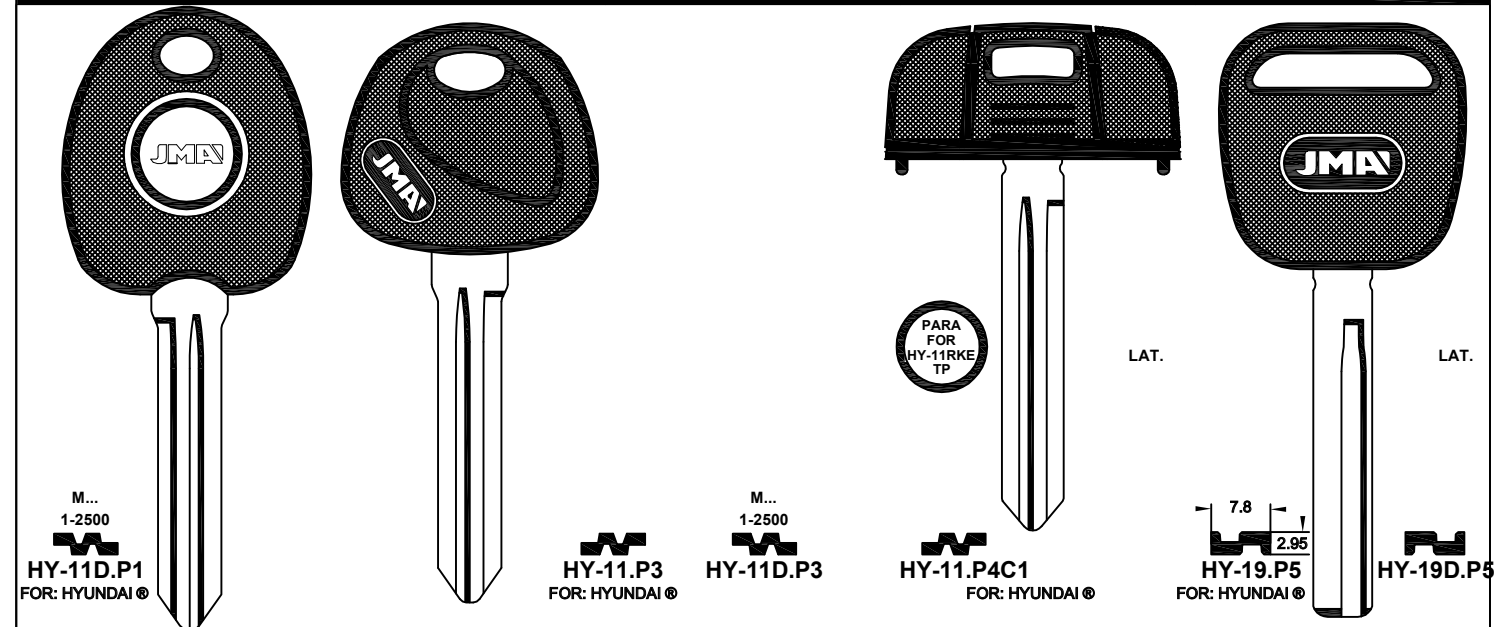

FOR: HYUNDAI®

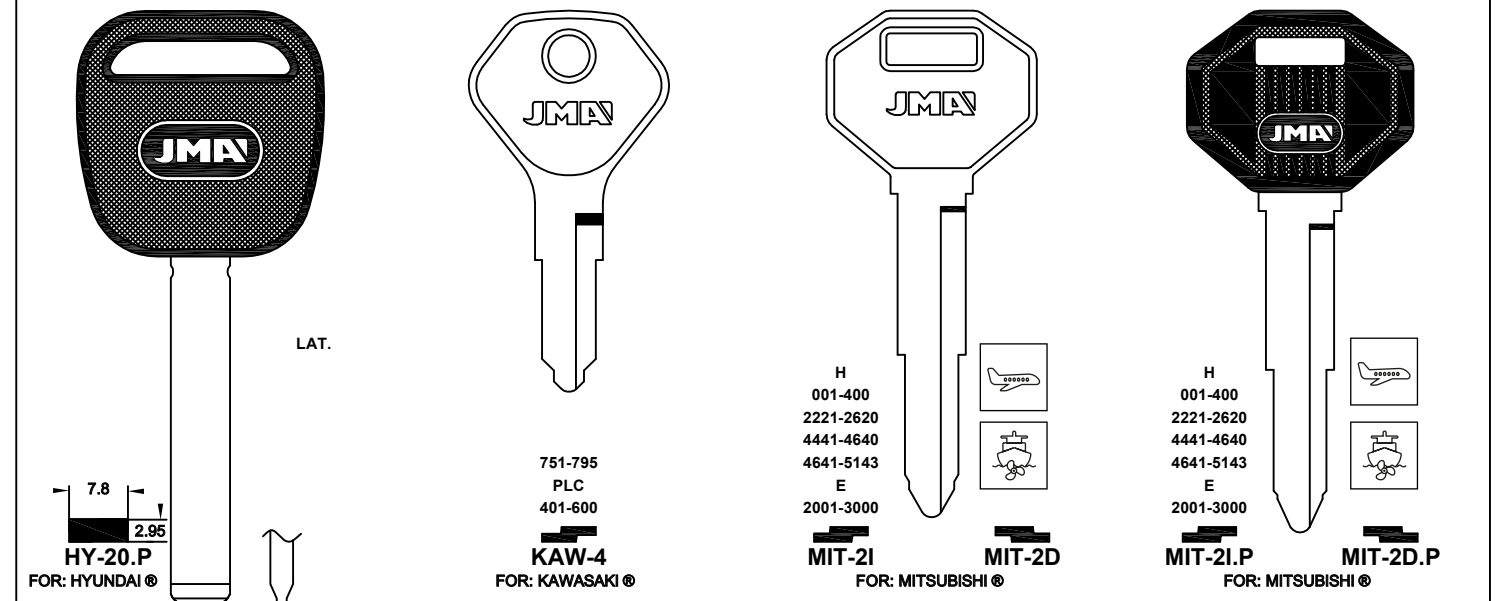

FOR: HYUNDAI®

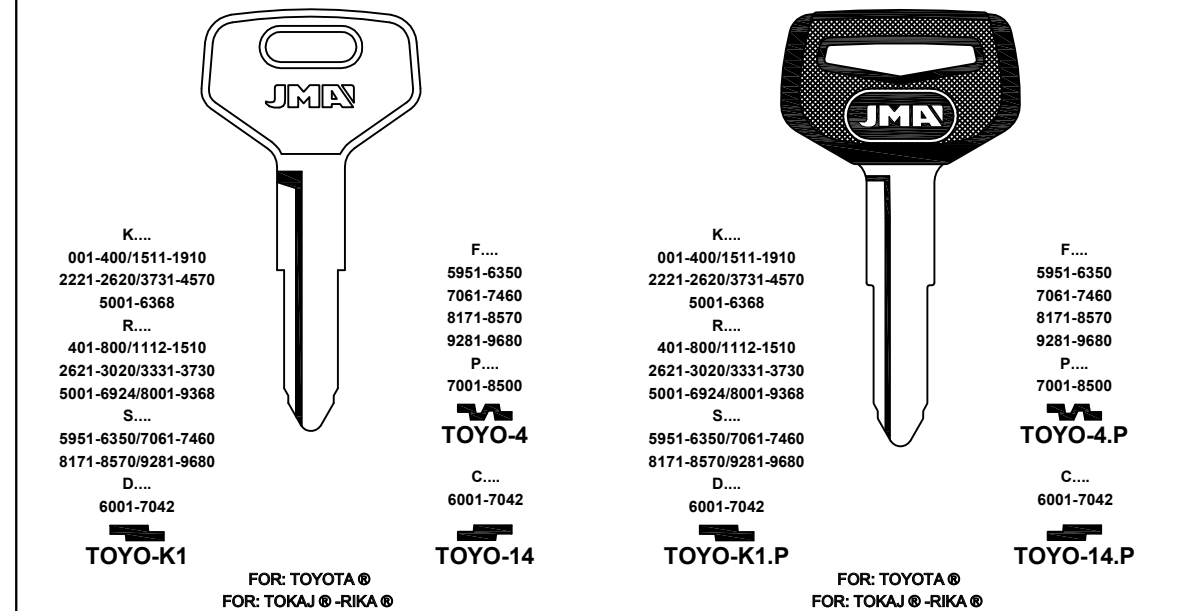

FOR: HYUNDAI(CANAD.)®

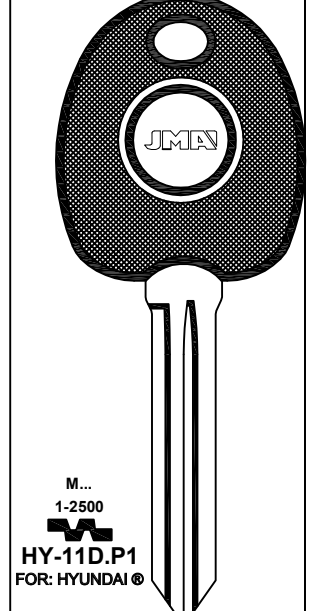

Concerning the marks and commercial denominations see legal warning.  
 Concerniente a las marcas y denominaciones comerciales ver aviso legal.  
 Marka eta izendapen komertzialiei dagokienez, ikus lege-oharra.  
 Concernant les marques et denominations commerciales voir la note dans l'index.

**JMA**® Opening the future

**JMA**® Opening the future

Beziehen auf die marke und handelsname sehen sie die notiz im Impressum.  
 Relativamente às marcas e denominações comerciais, ver aviso legal.  
 Jeśli chodzi o znaki i nazwy handlowe, patrz Informacje prawne.





FOR: INNOCENTI®

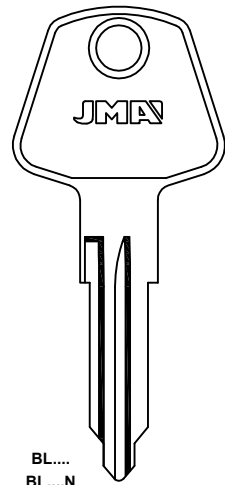

BL...  
BL...N  
1001-2000  
LF-BL

FOR: L. & F.®  
FOR: BRITAX®

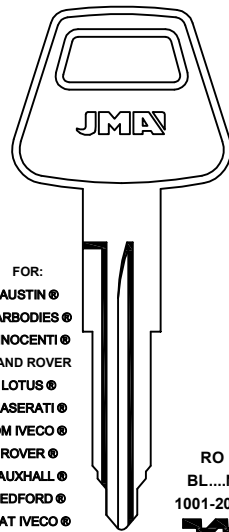

FOR:  
AUSTIN®  
CARBODIES®  
INNOCENTI®  
LAND ROVER®  
LOTUS®  
MASERATI®  
OM IVECO®  
ROVER®  
VAUXHALL®  
BEDFORD®  
FIAT IVECO®

RO  
BL...N  
1001-2000  
LF-RO

FOR: L. & F.®

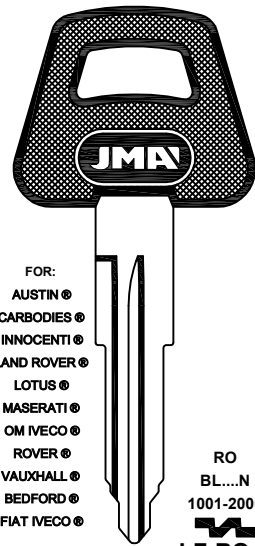

FOR:  
AUSTIN®  
CARBODIES®  
INNOCENTI®  
LAND ROVER®  
LOTUS®  
MASERATI®  
OM IVECO®  
ROVER®  
VAUXHALL®  
BEDFORD®  
FIAT IVECO®

RO  
BL...N  
1001-2000  
LF-RO.P

FOR: L. & F.®

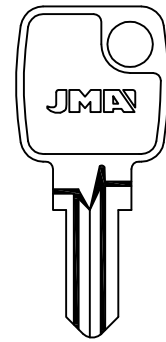

K...4-6-8  
K...4-6-8-A-B-C

PJ-K  
FOR: PJ®



K...4-6-8  
K...4-6-8-A-B-C

PJ-K.P  
FOR: PJ®

FOR: INNOCENTI®

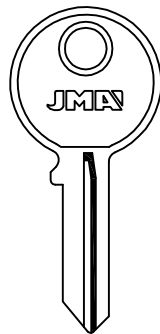

NRA  
FFE...1-100  
FJA...1-100  
FL...251-500  
NRA...51-90  
YFB...1-75  
FMD...1-75  
FG...1-30  
NF...1-30  
EJR...1-75

UN-FFE



UN-3

FP...  
626-750  
UN-FP

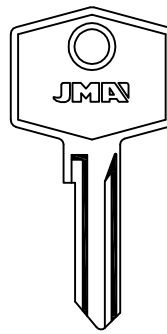

MC...1-40  
MRA...251-290  
MRN...1-54  
MRN...201-250  
MRN...251-300

UN-MRN

HX...100  
UN-2

FR...  
751-875  
UN-FR



FK...  
01-99  
876-955  
UN-FK

FS...  
01-99  
876-955  
UN-FS

FT-BC...301-360  
BC-FT...101-225  
LF...451-575  
CB...801-875

UN-FT

TF...1001-1140  
UN-TF

FOR: UNION®  
FOR: WBH®

FOR: G.M.®  
FOR: BRIGGS STRATTON®

FOR: INTER HARVESTER®

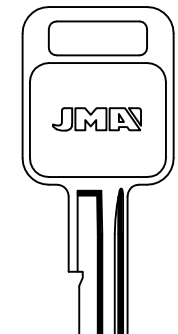

A  
000-999  
GM-6

E  
000-999  
GM-8

C  
000-999  
GM-7

J  
000-999  
GM-9

FOR: G.M.®  
FOR: BRIGGS STRATTON®

FOR: INTER.HARVESTER®

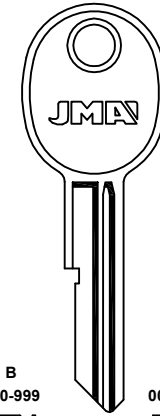

B  
000-999  
GM-B

H  
000-999  
GM-H

FOR: G.M.®  
FOR: BRIGGS STRATTON®

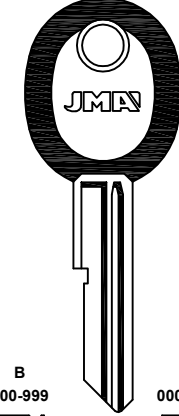

D  
000-999  
GM-D

K  
000-999  
GM-K

FOR: G.M.®  
FOR: BRIGGS STRATTON®

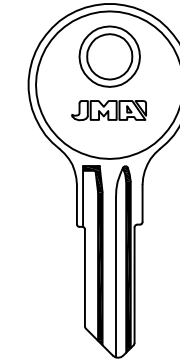

B  
000-999  
GM-B.P

H  
000-999  
GM-H.P

FOR: G.M.®  
FOR: BRIGGS STRATTON®

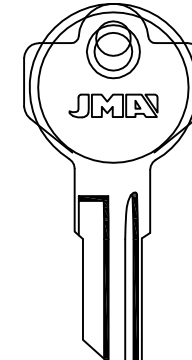

D  
000-999  
GM-D.P

K  
000-999  
GM-K.P

FOR: G.M.®  
FOR: BRIGGS STRATTON®

A...201-1050  
C...500-699  
H...601-1100  
HM...201-1050

HUD-1  
HUD-1D

FOR: HUDSON®

C...  
250-499  
1701-1950

KEN-1  
KEN-1D

FOR: KENWORTH®

FOR: IRMSCHER®

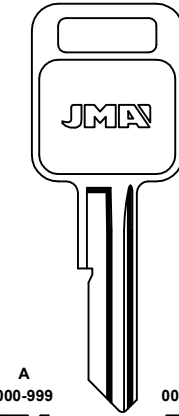

A  
000-999  
GM-6

E  
000-999  
GM-8

FOR: G.M.®  
FOR: BRIGGS STRATTON®

C  
000-999  
GM-7

J  
000-999  
GM-9

FOR: G.M.®  
FOR: BRIGGS STRATTON®

FOR: IRMSCHER®

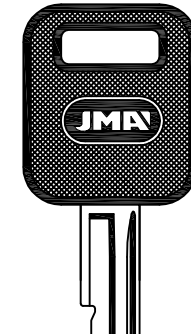

A  
000-999  
GM-6.P

E  
000-999  
GM-8.P

FOR: G.M.®  
FOR: BRIGGS STRATTON®

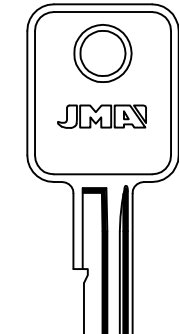

A  
000-999  
GM-A

E  
000-999  
GM-E

FOR: G.M.®  
FOR: BRIGGS STRATTON®

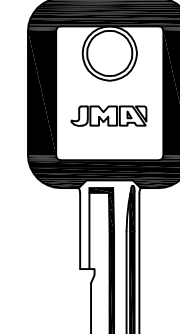

C  
000-999  
GM-C

J  
000-999  
GM-J

FOR: G.M.®  
FOR: BRIGGS STRATTON®

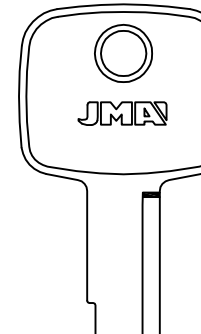

A  
000-999  
GM-A.P

E  
000-999  
GM-E.P

FOR: G.M.®  
FOR: BRIGGS STRATTON®

C  
000-999  
GM-C.P

J  
000-999  
GM-J.P

FOR: G.M.®  
FOR: BRIGGS STRATTON®

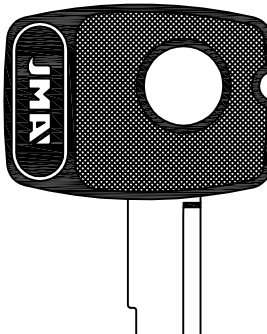

R...  
1-1500  
OP-R

FOR: HUF®  
FOR: YMOS®

R...  
1-1500  
OP-R.P

FOR: HUF®  
FOR: YMOS®

FOR: IRMSCHER®

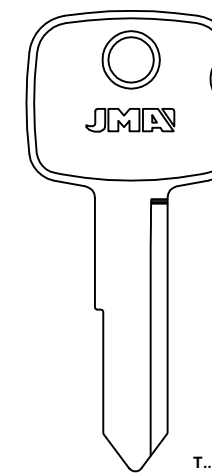

T...  
1-500  
501-1500  
OP-T

FOR: HUF®  
FOR: YMOS®

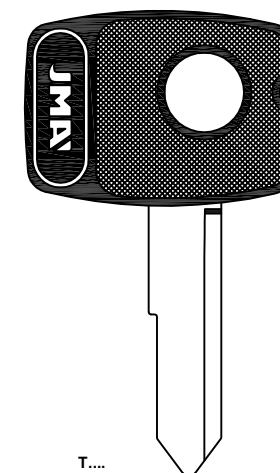

T...  
1-500  
501-1500  
OP-T.P

FOR: HUF®  
FOR: YMOS®

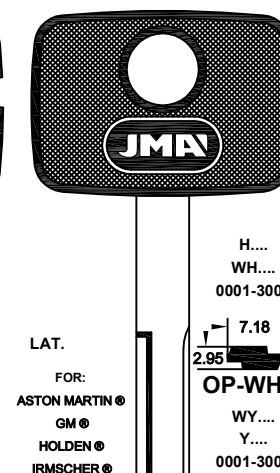

H...  
WH...  
0001-3000  
OP-WH.P

WY...  
Y...  
0001-3000  
OP-WY.P

FOR: HUF®  
FOR: YMOS®

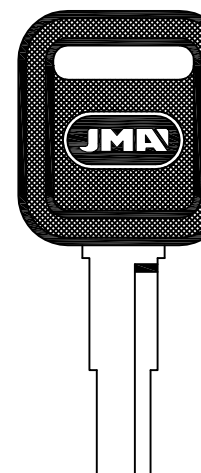

U  
7001-8200  
GM-1.P

FOR: G.M.®  
FOR: BRIGGS STRATTON®

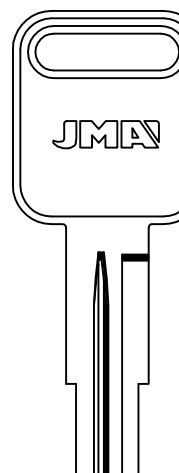

A  
8001-9400  
GM-2

FOR: G.M.®  
FOR: BRIGGS STRATTON®

FOR: INTER.HARVESTER®

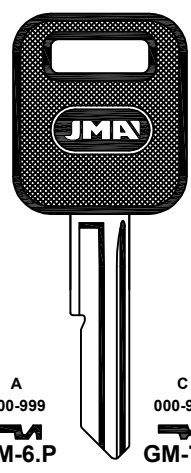

A  
000-999  
GM-6.P

E  
000-999  
GM-8.P

FOR: G.M.®  
FOR: BRIGGS STRATTON®

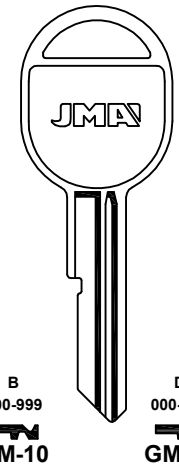

C  
000-999  
GM-7.P

J  
000-999  
GM-9.P

FOR: G.M.®  
FOR: BRIGGS STRATTON®

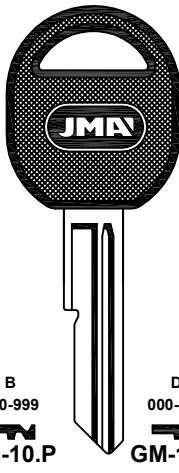

B  
000-999  
GM-10

H  
000-999  
GM-12

FOR: G.M.®  
FOR: BRIGGS STRATTON®

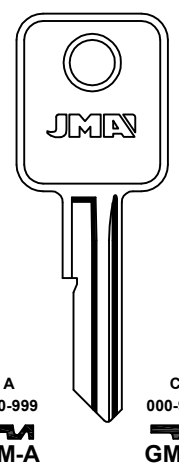

D  
000-999  
GM-11

K  
000-999  
GM-13

FOR: G.M.®  
FOR: BRIGGS STRATTON®

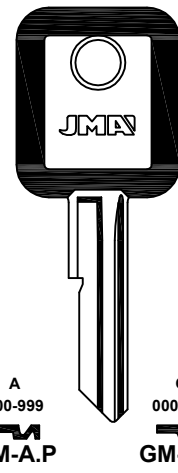

B  
000-999  
GM-10.P

H  
000-999  
GM-12.P

FOR: G.M.®  
FOR: BRIGGS STRATTON®

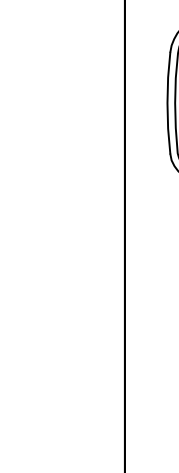

D  
000-999  
GM-11.P

K  
000-999  
GM-13.P

FOR: G.M.®  
FOR: BRIGGS STRATTON®

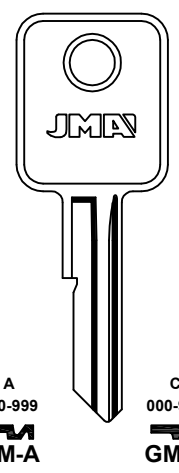

A  
000-999  
GM-A

E  
000-999  
GM-E

FOR: G.M.®  
FOR: BRIGGS STRATTON®

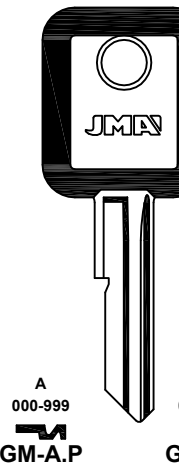

C  
000-999  
GM-C

J  
000-999  
GM-J

FOR: G.M.®  
FOR: BRIGGS STRATTON®

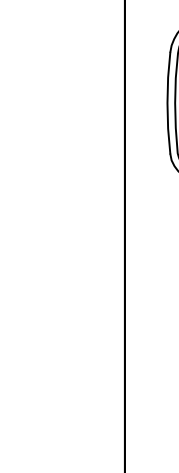

A  
000-999  
GM-A.P

E  
000-999  
GM-E.P

FOR: G.M.®  
FOR: BRIGGS STRATTON®

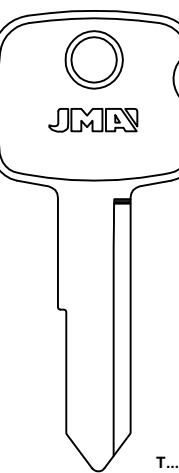

C  
000-999  
GM-C.P

J  
000-999  
GM-J.P

FOR: G.M.®  
FOR: BRIGGS STRATTON®

Concerning the marks and commercial denominations see legal warning.  
Concerniente a las marcas y denominaciones comerciales ver aviso legal.  
Marka eta izendapen komertzialiei dagokienez, ikus lege-oharra.  
Concernant les marques et denominations commerciales voir la note dans l'index.

**JMA** Opening the future

**JMA** Opening the future

Beziehen auf die Marke und Handelsname sehen Sie die Notiz im Impressum.  
Relativamente às marcas e denominações comerciais, ver aviso legal.  
Jeśli chodzi o znaki i nazwy handlowe, patrz Informacje prawne.

**K04** / 221

FOR: ISUZU ®

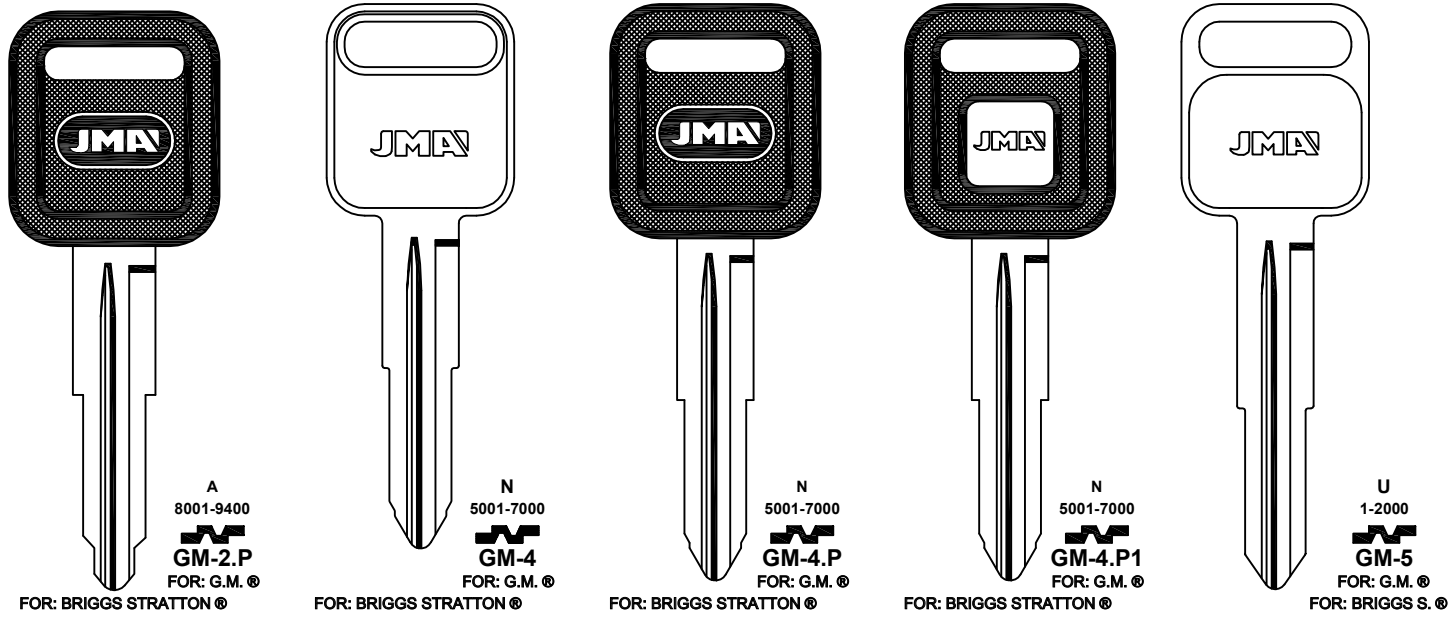

FOR: ISUZU ®

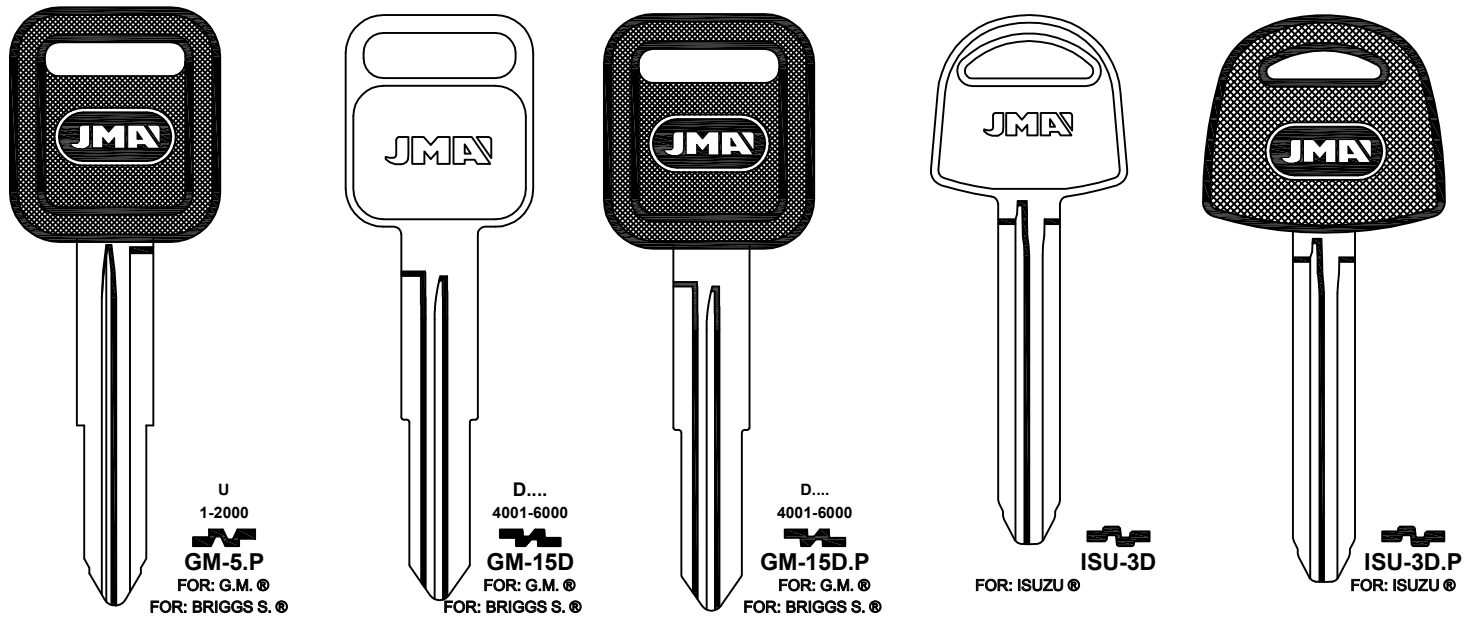

FOR: ISUZU ®

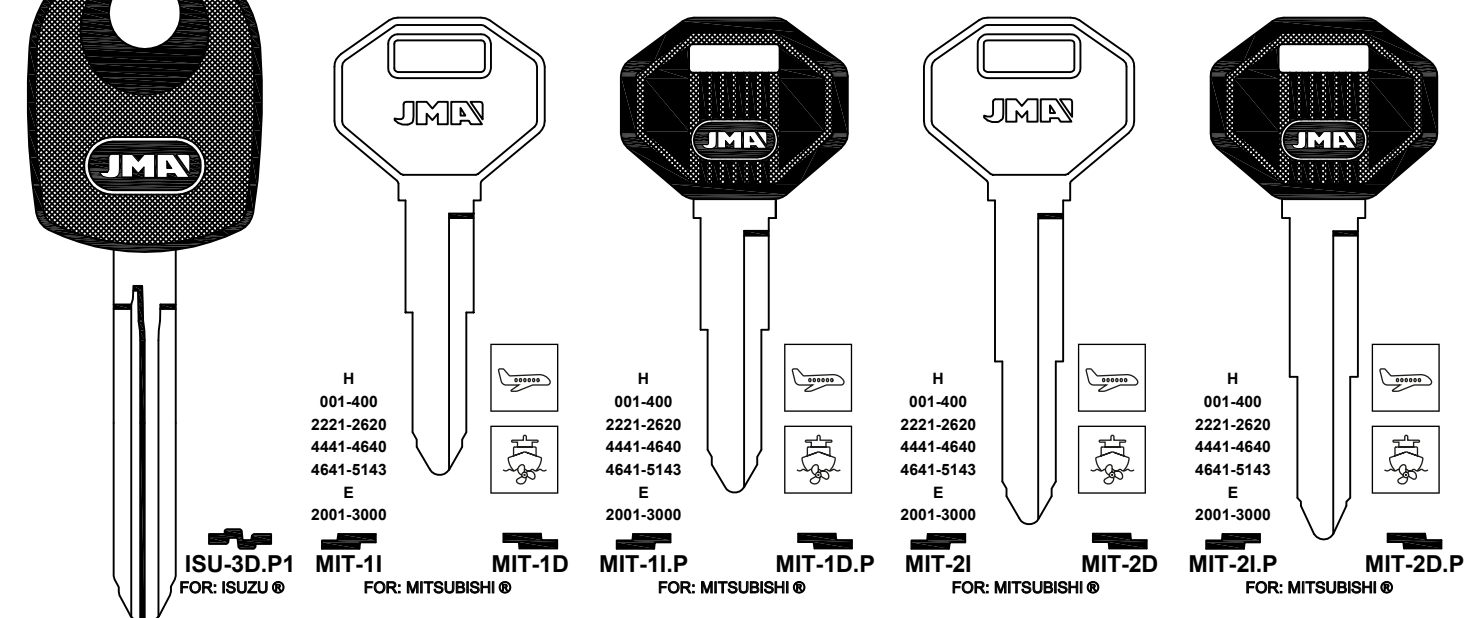

FOR: ISUZU ®

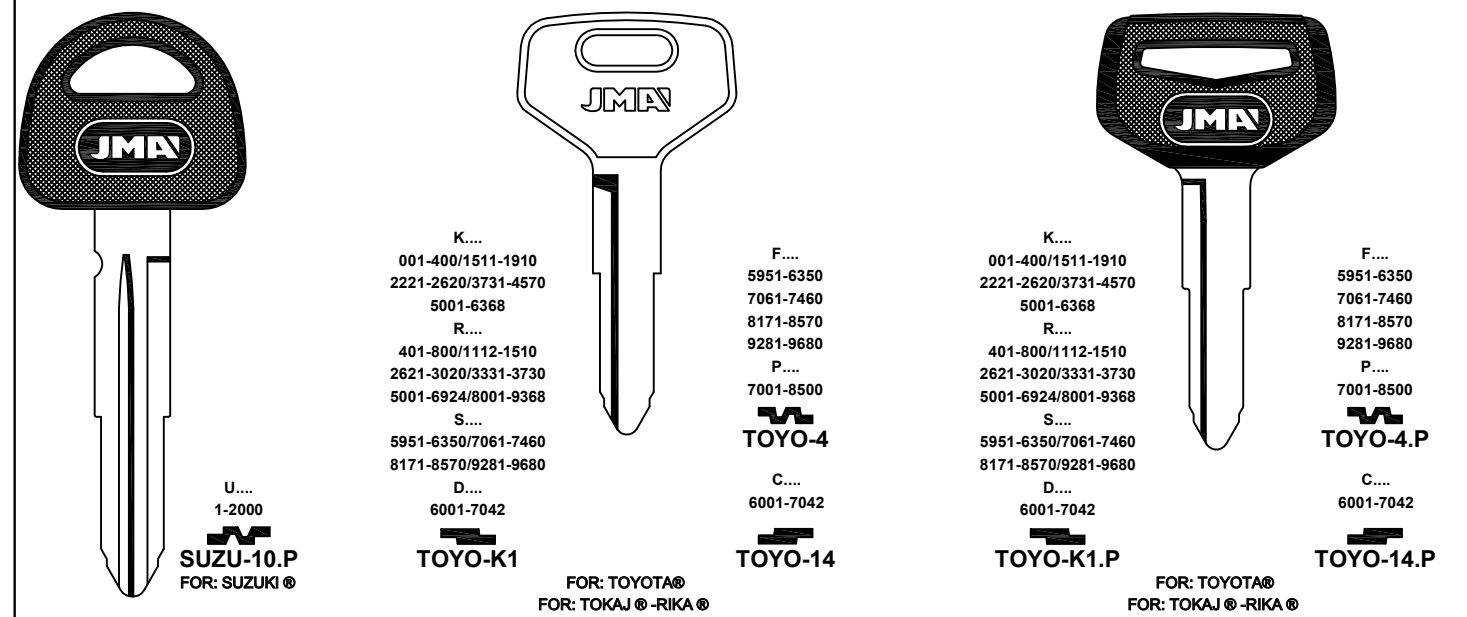

FOR: JAGUAR ®

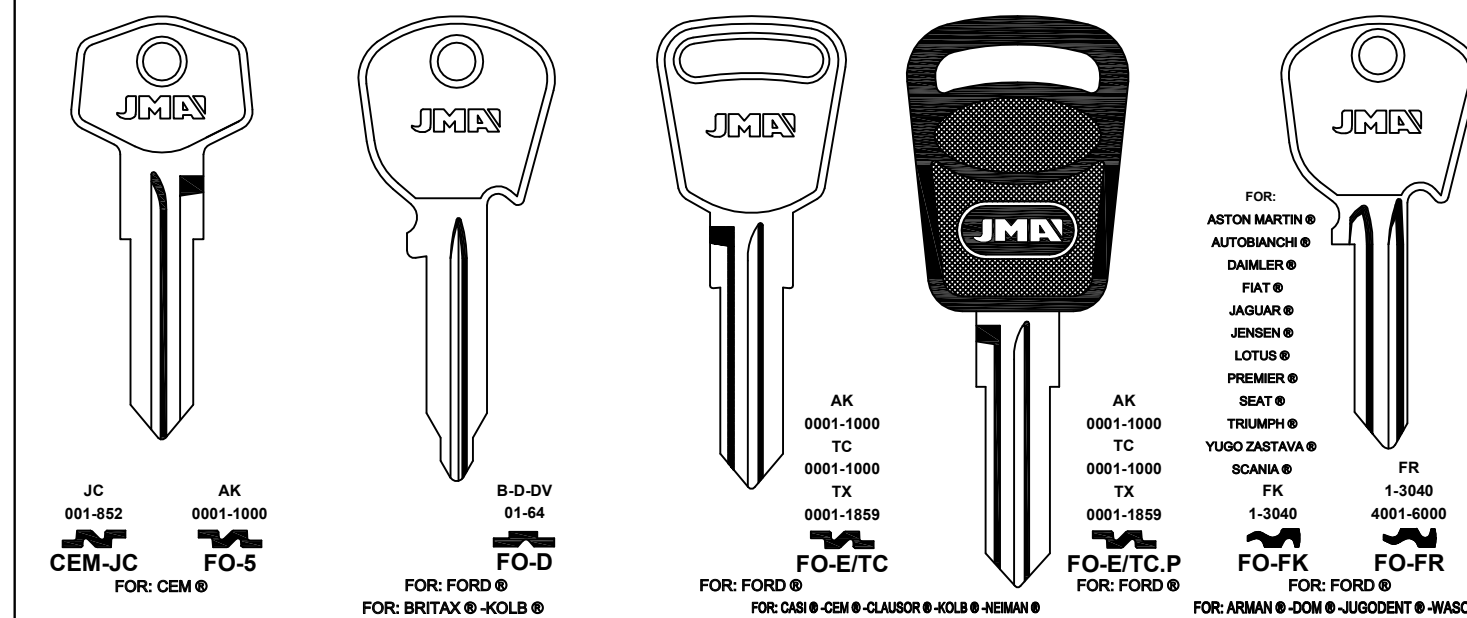

FOR: JAGUAR ®

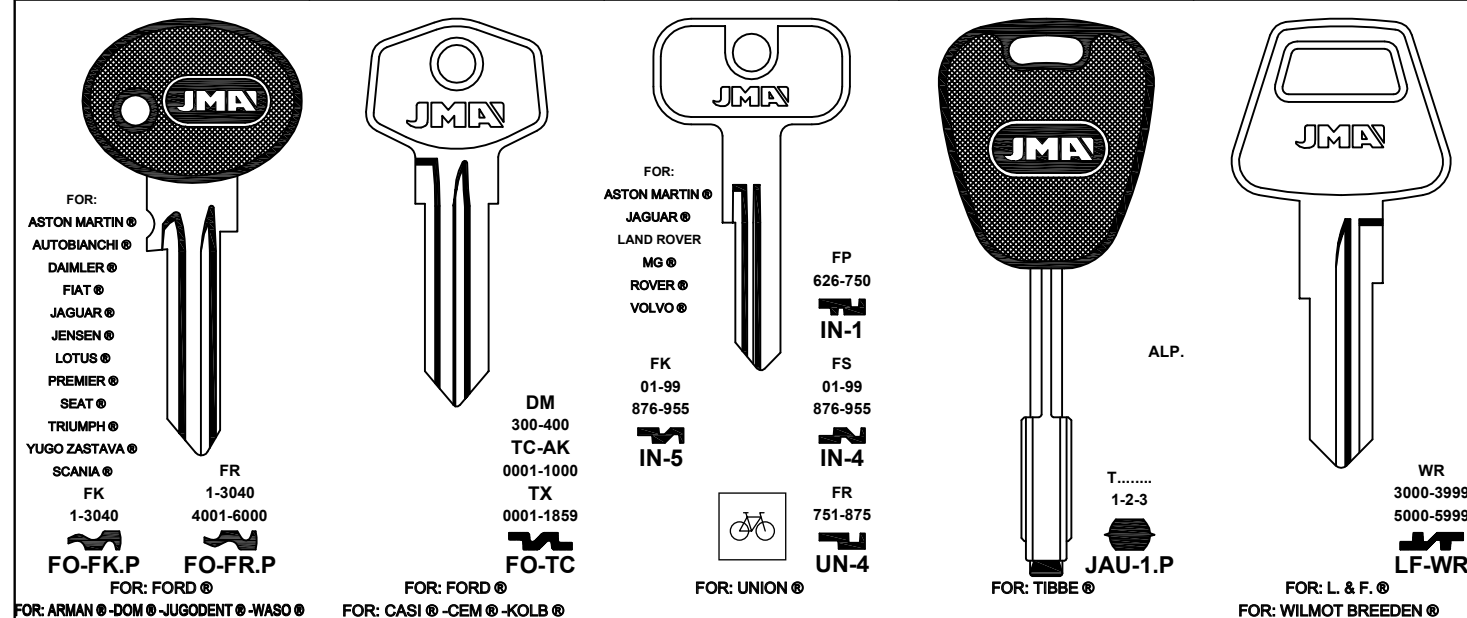

Concerning the marks and commercial denominations see legal warning.  
Concieniente a las marcas y denominaciones comerciales ver aviso legal.  
Marka eta izendapen komertzialiei dagokienez, ikus lege-oharra.  
Concernant les marques et denominations commerciales voir la note dans l'index.

**JMA** Opening the future

**JMA** Opening the future



Beziehen auf die marke und handelsname sehen sie die notiz im Impressum.  
Relativamente às marcas e denominações comerciais, ver aviso legal.  
Jeśli chodzi o znaki i nazwy handlowe, patrz Informacje prawne.



FOR: JAGUAR®



NRA  
FFE...1-100  
FJA...1-100  
FL...251-500  
NRA...51-90  
YFB...1-75  
FMD...1-75  
FG...1-30  
NF...1-30  
EJR...1-75

FP...  
626-750

UN-FFE UN-3 UN-FP

MC...1-40  
MRA...251-290  
MRN...1-54  
MRN...201-250  
MRN...251-300

HX...100

UN-MRN UN-2 UN-FR

FR...  
751-875

UN-FR

FK...  
01-99  
876-955

FS...  
01-99  
876-955

UN-FK UN-FS

FT-BC...301-360  
BC-FT...101-225  
LF...451-575  
CB...801-875

TF  
TF...1001-1140

UN-FT UN-TF

W...  
600-842

WAS-1  
FOR: WASO®

FS...1-99  
FS...876-955

FA...  
501-625

RM...  
911-952

UN-1FS UN-44 UN-44D





FOR: UNION®

UN-NG

FOR: UNION®  
FOR: WBH®

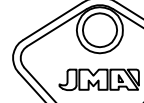
FOR: UNION®  
FOR: CEM®

FOR: JEEP®

L... 1-3580  
CHR-14.P  
FOR: CHRYSLER®  
FOR: BRIGGS & STRATTON® -YALE®

CL-4I  
FOR: CLAUSOR®

F 01-78  
E 01-78

FEM-1I FEM-1D  
H 01-78 G 01-78  
FEM-2I FEM-2D

A 000-999  
GM-6  
E 000-999  
GM-8

C 000-999  
GM-7  
J 000-999  
GM-9

A 000-999  
GM-6.P  
E 000-999  
GM-8.P

C 000-999  
GM-7.P  
J 000-999  
GM-9.P





FOR: G.M.®  
FOR: BRIGGS STRATTON®

FOR: G.M.®  
FOR: BRIGGS STRATTON®

FOR: JAGUAR®

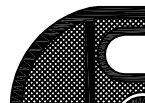
FOR: JDM®

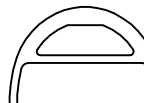
FOR: JEEP®

ALP.

LAT.

LAT.

GC...  
101-150  
HC...  
0-499

A...250-1500  
AP...250-1500  
B...250-1500  
C...1251-1700  
CB...250-1500  
DC-EP...250-699  
P...250-1500

BS-4D

FR...4001-6000  
FZ...1-1232

WAS-2.P  
FOR: WASO®  
FOR: ARMAN® -DOM®

0111111  
AL  
628888





SIX-3.P  
FOR: SIMPLEX®

AMM-1  
FOR: AMERICAN MOT.®

AMM-2  
FOR: AMERICAN MOT.®

BS-6  
FOR: B & S®

FOR: JEEP®

A 000-999  
GM-A  
E 000-999  
GM-E

C 000-999  
GM-C  
J 000-999  
GM-J

A 000-999  
GM-A.P  
E 000-999  
GM-E.P

C 000-999  
GM-C.P  
J 000-999  
GM-J.P

A...201-1050  
C...500-699  
H...601-1100  
HM...201-1050

HUD-1 HUD-1D  
FOR: HUDSON®

C...  
250-499  
1701-1950

KEN-1 KEN-1D  
FOR: KENWORTH®





DC...551-952  
YA-8I YA-8D  
YA-9I  
FOR: YALE®

FOR: G.M.®  
FOR: BRIGGS STRATTON®

FOR: G.M.®  
FOR: BRIGGS STRATTON®

FOR: BASCO® -BRIGGS&STRATTON® -YALE®

FOR: JEEP®

F... G...  
0000-1394

CHR-9  
FOR: CHRYSLER®  
FOR: YALE®

F... G...  
0000-1394

CHR-9.P  
FOR: CHRYSLER®  
FOR: YALE®

J...  
0001-3580

CHR-10  
FOR: CHRYSLER®  
FOR: YALE®

J...  
0001-3580

CHR-10.P  
FOR: CHRYSLER®  
FOR: YALE®





L... 1-3580

CHR-14  
FOR: CHRYSLER®  
FOR: BRIGGS & STRATTON® -YALE®

FOR: JEEP®

FOR: JENSEN®

FOR: KENWORTH®

FOR: ABUS®  
BENDIX®  
CAB®  
CHICAGO®  
COLE HERSEE®

USA GB  
ALU.

FOR: ASTON MARTIN®  
AUTOBIANCHI®  
DAIMLER®  
FIAT®  
JAGUAR®  
JENSEN®  
LOTUS®  
PREMIER®  
SEAT®  
TRIUMPH®  
YUGO ZASTAVA®

FR 1-3040  
4001-6000

FO-FK FO-FR  
FOR: FORD®

FR 1-3040  
4001-6000

FO-FK.P FO-FR.P  
FOR: FORD®

FOR: ARMAN® -DOM® -JUGODENT® -WASO®

FR 1-3040  
4001-6000

FK...  
01-99  
876-955

UN-FK  
FOR: UNION®

FS...  
01-99  
876-955

UN-FS  
FOR: WBH®

A...201-1050  
C...500-699  
H...601-1100  
HM...201-1050

HUD-1 HUD-1D  
FOR: HUDSON®

Concerning the marks and commercial denominations see legal warning.  
Concerniente a las marcas y denominaciones comerciales ver aviso legal.  
Marka eta izendapen komertzialiei dagokienez, ikus lege-oharra.  
Concernant les marques et denominations commerciales voir la note dans l'index.

**JMA** Opening the future

**JMA** Opening the future

Beziehen auf die Marke und Handelsname sehen sie die notiz im Impressum.  
Relativamente às marcas e denominações comerciais, ver aviso legal.  
Jeśli chodzi o znaki i nazwy handlowe, patrz Informacje prawne.



FOR: KENWORTH®

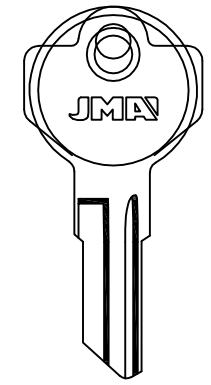

C....  
250-499  
1701-1950



**KEN-1**  
FOR: KENWORTH®

FOR: KIA®

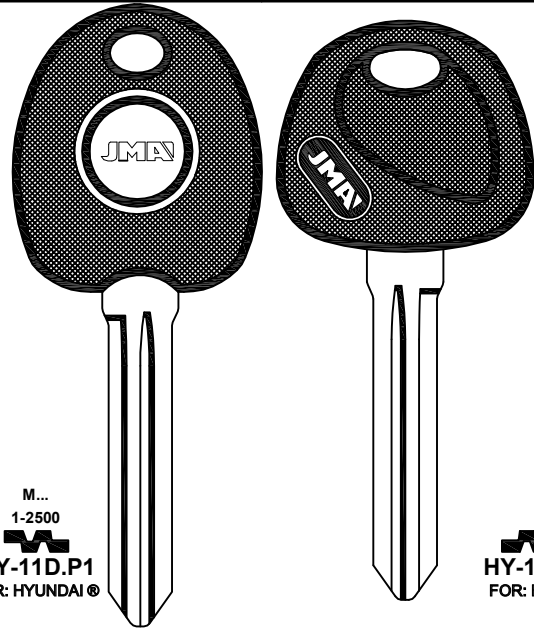

M...  
1-2500  
**HY-11D.P1**  
FOR: HYUNDAI®

M...  
1-2500  
**HY-11.P3**  
FOR: HYUNDAI®

WA...  
1001-3040  
**HY-12.P3**  
FOR: HYUNDAI®

FOR: LADA-BAKONY®

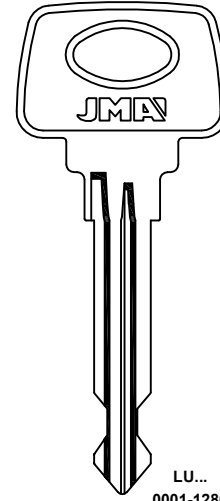

LU...  
0001-1280  
**LA-1D**  
FOR: LADA-BAKONY®

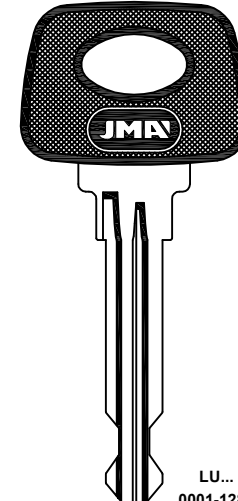

LU...  
0001-1280  
**LA-1D.P**  
FOR: LADA-BAKONY®

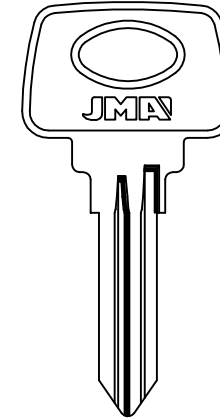

TU...  
0001-1000  
**LA-2**  
FOR: LADA-BAKONY®

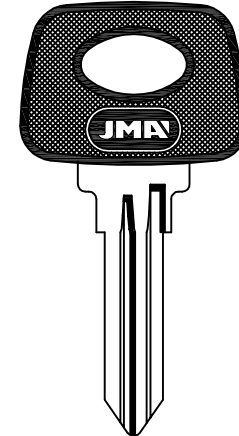

TU...  
0001-1000  
**LA-2.P**  
FOR: LADA-BAKONY®

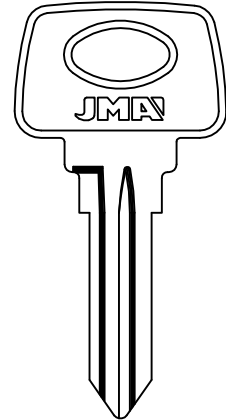

....  
0 AL 3  
**LA-3D**  
FOR: LADA-MOSKVITCH®

FOR: KIA®

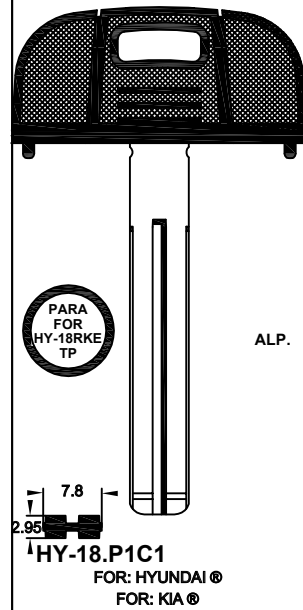

PARA  
FOR  
HY-18RKE  
TP

7.8  
2.95  
**HY-18.P1C1**  
FOR: HYUNDAI®  
FOR: KIA®

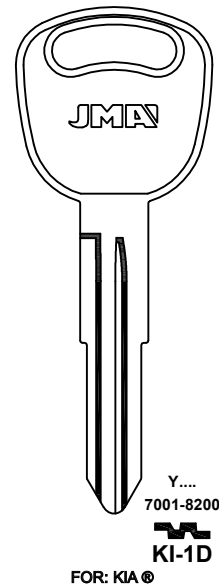

Y...  
7001-8200  
**KI-1D**  
FOR: KIA®

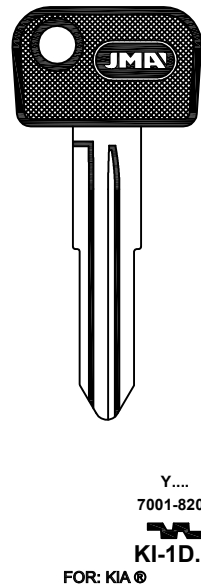

Y...  
7001-8200  
**KI-1D.P**  
FOR: KIA®

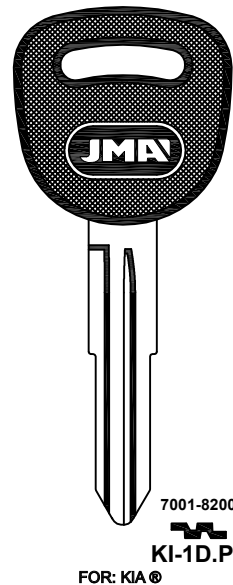

Y...  
7001-8200  
**KI-1D.P1**  
FOR: KIA®

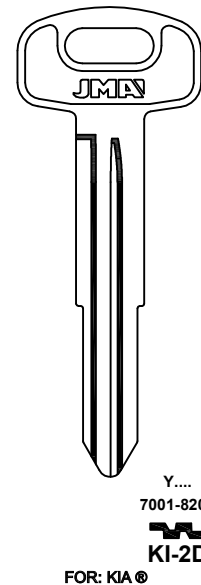

Y...  
7001-8200  
**KI-2D**  
FOR: KIA®

FOR: LADA-BAKONY®

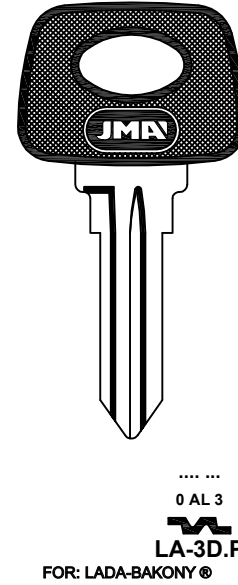

....  
0 AL 3  
**LA-3D.P**  
FOR: LADA-BAKONY®

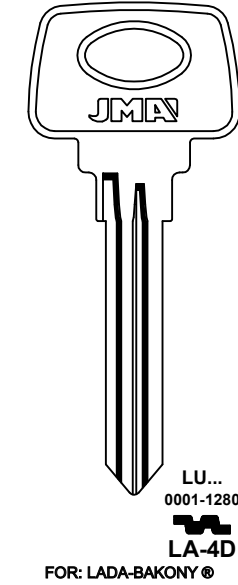

LU...  
0001-1280  
**LA-4D**  
FOR: LADA-BAKONY®

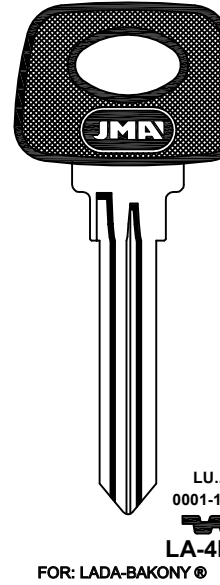

LU...  
0001-1280  
**LA-4D.P**  
FOR: LADA-BAKONY®

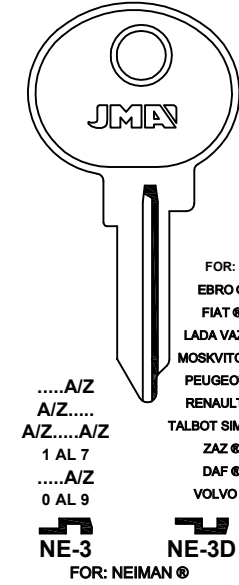

FOR:  
EBRO®  
FIAT®  
LADA VAZ®  
MOSKVITCH®  
PEUGEOT®  
RENAULT®  
TALBOT SIMCA®  
ZAZ®  
DAF®  
VOLVO®

....A/Z  
A/Z.....  
A/Z.....A/Z  
1 AL 7  
....A/Z  
0 AL 9  
**NE-3**  
FOR: NEIMAN®  
FOR: CLAUSOR®

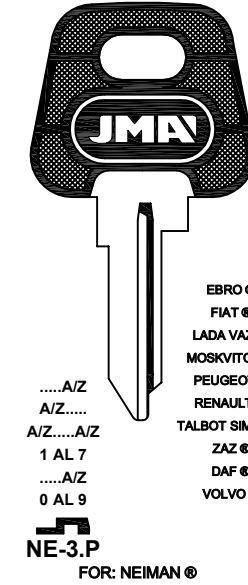

FOR:  
EBRO®  
FIAT®  
LADA VAZ®  
MOSKVITCH®  
PEUGEOT®  
RENAULT®  
TALBOT SIMCA®  
ZAZ®  
DAF®  
VOLVO®

....A/Z  
A/Z.....  
A/Z.....A/Z  
1 AL 7  
....A/Z  
0 AL 9  
**NE-3.P**  
FOR: NEIMAN®  
FOR: CLAUSOR®

FOR: KIA®

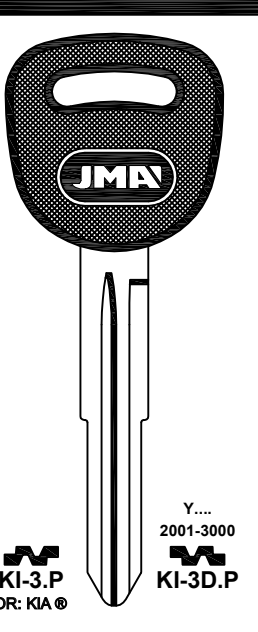

Y...  
2001-3000  
**KI-3.P**  
FOR: KIA®

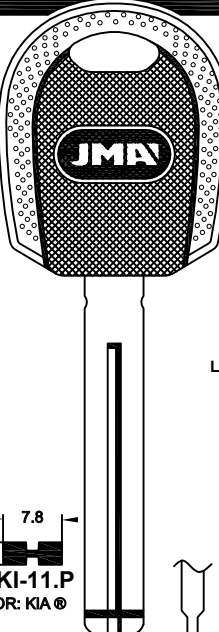

7.8  
2.95  
**KI-11.P**  
FOR: KIA®

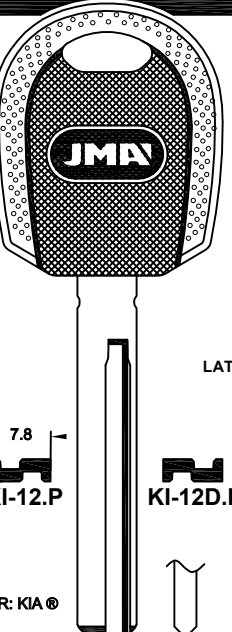

LAT.  
7.8  
2.95  
**KI-12.P**  
FOR: KIA®

FOR: LADA VAZ®

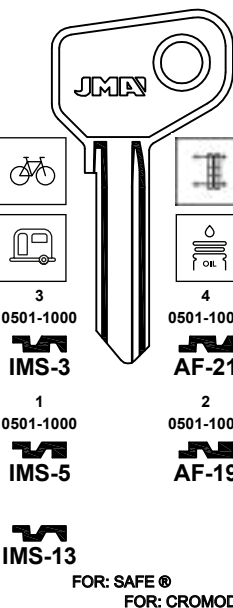

3  
0501-1000  
**IMS-3**  
0501-1000  
**IMS-5**  
IMS-13  
FOR: SAFE®

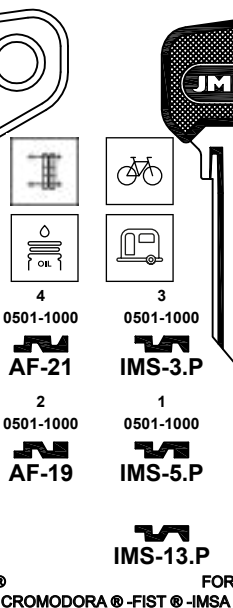

4  
0501-1000  
**AF-21**  
0501-1000  
**AF-19**  
IMS-13.P  
FOR: SAFE®  
FOR: CROMODORA® -FIST® -IMS®

FOR: LADA-BAKONY®

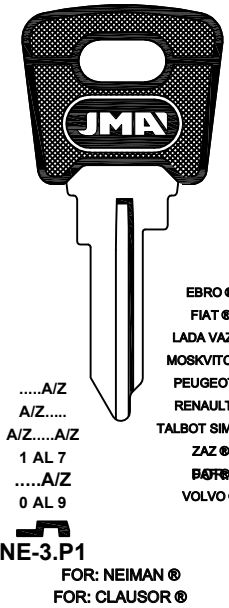

EBRO®  
FIAT®  
LADA VAZ®  
MOSKVITCH®  
PEUGEOT®  
RENAULT®  
TALBOT SIMCA®  
ZAZ®  
DAF®  
VOLVO®

....A/Z  
A/Z.....  
A/Z.....A/Z  
1 AL 7  
....A/Z  
0 AL 9  
**NE-3.P1**  
FOR: NEIMAN®  
FOR: CLAUSOR®

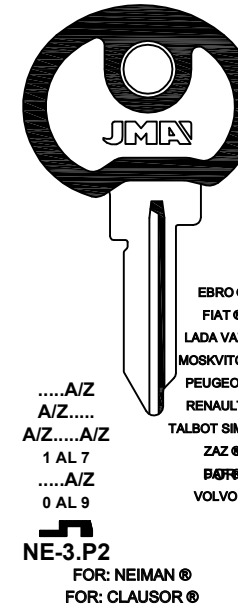

EBRO®  
FIAT®  
LADA VAZ®  
MOSKVITCH®  
PEUGEOT®  
RENAULT®  
TALBOT SIMCA®  
ZAZ®  
DAF®  
VOLVO®

....A/Z  
A/Z.....  
A/Z.....A/Z  
1 AL 7  
....A/Z  
0 AL 9  
**NE-3.P2**  
FOR: NEIMAN®  
FOR: CLAUSOR®

FOR: LAMBORGHINI®

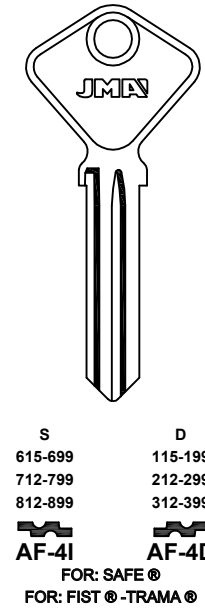

FOR:  
CROMODORA®  
FIST®  
GLOBERT®  
MIRAGLIO®  
RUFFINI®

S  
615-699  
712-799  
812-899  
**AF-4I**  
FOR: SAFE®  
FOR: FIST® -TRAMA®

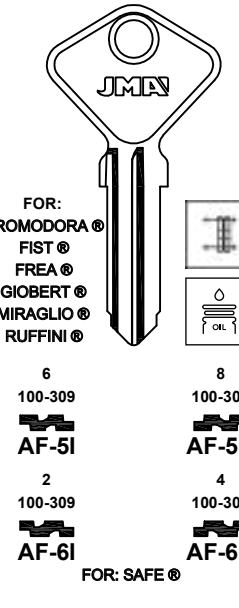

FOR: SAFE®

6  
100-309  
**AF-5I**  
100-309  
**AF-6I**  
FOR: SAFE®

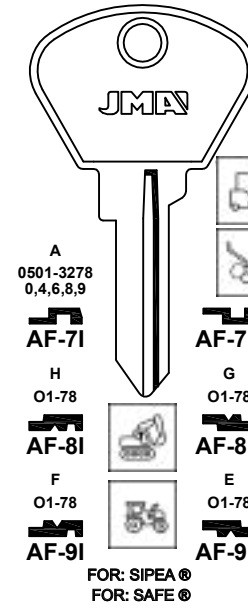

A  
0501-3278  
0,4,6,8,9  
**AF-7I**  
H  
01-78  
**AF-8I**  
F  
01-78  
**AF-9I**  
FOR: SIPEA®  
FOR: SAFE®

Concerning the marks and commercial denominations see legal warning.  
Concerniente a las marcas y denominaciones comerciales ver aviso legal.  
Marka eta izendapen komertzialiei dagokienez, ikus lege-oharra.  
Concernant les marques et denominations commerciales voir la note dans l'index.

FOR: LAMBORGHINI®

A  
0501-3278  
0,4,6,8,9  
AF-71.P  
H  
01-78  
AF-81.P  
G  
01-78  
AF-8D.P  
F  
01-78  
AF-91.P  
E  
01-78  
AF-9D.P  
FOR: SIPEA®  
FOR: SAFE®

A  
0501-3278  
0,4,6,8,9  
AF-71.P1  
FOR: SIPEA®  
FOR: NEIMAN®

E,M,N,U,H,K  
001-100  
HG,N  
140-189  
HG  
040-100  
BH-1  
FOR: BOSCH®  
FOR: NEIMAN®

E,M,N,U,H,K  
001-100  
HG,N  
140-189  
HG  
040-100  
BH-1.P  
FOR: BOSCH®  
FOR: NEIMAN®

3  
0501-1000  
IMS-3  
1  
0501-1000  
IMS-5  
4  
0501-1000  
AF-21  
2  
0501-1000  
AF-19  
IMS-13  
FOR: SAFE®  
FOR: CROMODORA® -FIST® -IMSA®

FOR: LANCIA®

FOR:  
ALFA ROMEO®  
AUTOBIANCHI®  
CITROEN®  
FERRARI®  
FIAT®  
INNOCENTI®  
LANCIA®  
PEUGEOT®  
YUGO ZASTAVA  
CAGIVA®  
DUCATI®  
FANTIC MOTOR®  
GARELLI®  
GILERA®  
FI-6I  
FOR: GIOBERT®

K 3301-4886  
K 7001-8092  
T 5000-6027  
T 7001-8092  
S 0501-3278  
H 7001-8092  
FI-6I.P  
FOR: GIOBERT®

FOR:  
FERRARI®  
FIAT®  
INNOCENTI®  
LANCIA®  
FI-6I.P1  
FOR: GIOBERT®

K 3301-4886  
K 7001-8092  
T 5000-6027  
T 7001-8092  
S 0501-3278  
H 7001-8092  
FI-6I.P2  
FOR: GIOBERT®

AUTOBIANCHI®  
CITROEN®  
FERRARI®  
FIAT®  
LANCIA®  
PEUGEOT®  
YUGO ZASTAVA  
CAGIVA®  
DUCATI®  
FANTIC MOTOR®  
GARELLI®  
GILERA®  
FI-6I.P3  
FOR: GIOBERT®

FOR: LAMBORGHINI®

3  
0501-1000  
IMS-3.P  
1  
0501-1000  
IMS-5.P  
IMS-13.P  
FOR: SAFE®  
FOR: CROMODORA® -FIST® -IMSA®

FOR: LANCIA®

A  
0501-3278  
0,4,6,8,9  
AF-7I  
H  
01-78  
AF-8I  
F  
01-78  
AF-9I  
G  
01-78  
AF-7D  
G  
01-78  
AF-8D  
E  
01-78  
AF-9D  
A  
0501-3278  
0,4,6,8,9  
AF-7I.P  
H  
01-78  
AF-8I.P  
F  
01-78  
AF-9I.P  
G  
01-78  
AF-8D.P  
G  
01-78  
AF-9D.P  
1  
100-789  
AF-10  
3  
100-789  
AF-11  
5  
100-789  
AF-12  
K-H  
7001-8092  
AF-14.P  
K.3301-4886  
K.7001-8092  
T.5000-6027  
T.7001-8092  
S.0501-3278  
H.7001-8092  
FI-6I.P4  
FOR: SIPEA®  
FOR: SAFE®

FOR: SIPEA®  
FOR: SAFE®

FOR: SIPEA®  
FOR: SAFE®

FOR: SAFE®

FOR: GIOBERT®  
FOR: FIAT® -M.MARELLI® -NEIMAN® -SIPEA®

FOR: LANCIA®

M  
0001-1050  
FI-9I  
FOR: GIOBERT®

M  
0001-1050  
FI-9I.P  
FOR: GIOBERT®

N 6001-7000  
J 3001-6732  
V 0001-3051  
V 5001-8058  
AB 6001-6891  
FI-11  
FOR: GIOBERT®

N 6001-7000  
J 3001-6732  
V 0001-3051  
V 5001-8058  
AB 6001-6891  
FI-11.P  
FOR: GIOBERT®

W  
0001-9640  
FI-13  
FOR: GIOBERT®

FOR: LANCIA®

J  
3001-6732  
N  
6001-7000  
FI-1  
J  
3001-6732  
N  
6001-7000  
FI-10  
FOR: GIOBERT®

J  
3001-6732  
N  
6001-7000  
FI-1.P  
J  
3001-6732  
N  
6001-7000  
FI-10.P  
FOR: GIOBERT®

Z-GR  
7001-9956  
FI-2D  
G  
2001-4530  
G-Z  
7001-9956  
FI-3  
G  
2001-4530  
G-Z  
7001-9956  
FI-3D  
G  
7001-9956  
FI-12  
FOR: GIOBERT®

Z-GR  
7001-9956  
FI-2D.P3  
G  
2001-4530  
G-Z  
7001-9956  
FI-3D.P3  
G  
7001-9956  
FI-12.P3  
FOR: GIOBERT®

Z-GR  
7001-9956  
FI-2D  
G  
2001-4530  
G-Z  
7001-9956  
FI-3D.P  
G  
7001-9956  
FI-12.P  
FOR: GIOBERT®

FOR:  
ALFA ROMEO®  
CITROEN®  
FIAT®  
INNOCENTI®  
LANCIA®  
SEAT®  
YUGO ZASTAVA®  
FOR: GIOBERT®

FOR: LANCIA®

W  
0001-9640  
FI-13.P  
FOR: GIOBERT®

W  
0001-9640  
FI-14.P  
FOR: GIOBERT®

FI-16.P1  
FOR: TRW-SIPEA®  
FOR: GIOBERT®

LAT.  
GIOB-2I  
FOR: GIOBERT®

GIOB-2I.P  
FOR: GIOBERT®

Concerning the marks and commercial denominations see legal warning.  
Concerniente a las marcas y denominaciones comerciales ver aviso legal.  
Marka eta izendapen komertzialiei dagokienez, ikus lege-oharra.  
Concernant les marques et denominations commerciales voir la note dans l'index.



**FOR: LANCIA ®**

ALP.

0111111  
FOR: AL ®  
628888

B....501-3278  
B.....0-4-6-8-9

SIP-3  
FOR: SIPEA ®

SIX-3.P1  
FOR: SIMPLEX ®

FOR: ARTEB ® -CLAUSOR ® -NEIMAN ® FOR: CITROEN ® -FIAT ® -LANCIA ® -PEUGEOT ®

**FOR: LAND-RANGE ROVER ®**

15

AB-6I AB-6D  
FOR: PROAUTO ®

14 13

AB-8I AB-8D  
FOR: ABSA ®

2,3,4,5,6,7,8

IMS-7  
FOR: IMSA ®

2,3,4,5,6,7,8

IMS-7.P  
FOR: IMSA ®

**FOR: LAND-RANGE ROVER ®**

NRA  
FFE...1-100  
FJA...1-100  
FL...251-500  
NRA...51-90  
YFB...1-75  
FMD...1-75  
FG...1-30  
NF...1-30  
EJR...1-75

UN-FFE UN-3 UN-FP

MC...1-40  
MRA...251-290  
MRN...1-54  
MRN...201-250  
MRN...251-300

UN-MRN UN-2 UN-FR

FR...  
626-750  
UN-FP

FR...  
751-875  
UN-FR

FA...  
501-625  
UN-44

RM...  
911-952  
UN-44D

UN-NG

UN-1FS

FS...1-99  
FS...876-955

L.....  
8001-10000  
NE-52.P  
FOR: NEIMAN ®

FK...  
01-99  
876-955  
UN-FK

FS...  
01-99  
876-955  
UN-FS

FOR: UNION ® FOR: WBH ®

**FOR: LAND-RANGE ROVER ®**

FOR: ASTON MARTIN ® JAGUAR ® LAND ROVER ® MG ® ROVER ® VOLVO ®

FP 626-750  
IN-1

FOR: AUSTIN ® CARBODIES ® INNOCENTI ® LAND ROVER ® LOTUS ® MASERATI ® OM IVECO ® ROVER ® VAUXHALL ® BEDFORD ® FIAT IVECO ®

RO BL...N  
1001-2000  
LF-RO

FOR: L. & F. ®

FOR: AUSTIN ® CARBODIES ® INNOCENTI ® LAND ROVER ® LOTUS ® MASERATI ® OM IVECO ® ROVER ® VAUXHALL ® BEDFORD ® FIAT IVECO ®

RO BL...N  
1001-2000  
LF-RO.P

FOR: L. & F. ®

NSP....  
4000-4999  
7001-9000  
E....  
2001-3000  
4001-5000  
S....  
2001-3000  
NE-11

FOR: NEIMAN ®

NSP....  
4000-4999  
7001-9000  
E....  
2001-3000  
4001-5000  
S....  
2001-3000  
NE-11.P

FOR: NEIMAN ®

**FOR: LAND-RANGE ROVER ®**

FT-BC...301-360  
BC-FT...101-225  
LF...451-575  
CB...801-875

UN-FT

TF  
TF...1001-1140  
UN-TF

NH...  
2001-3000  
UN-NH

FOR: UNION ® FOR: CEM ®

**FOR: LEXUS (TOYOTA) ®**

LAT.

TOYO-41.P

TOYO-18.P  
FOR: TOYOTA ®

TOYO-30.P1  
FOR: TOYOTA ®

ALP.

**FOR: LIGIER ®**

0111111  
AL  
628888

SIX-3.P  
FOR: SIMPLEX ®

**FOR: LAND-RANGE ROVER ®**

NSP....  
4000-4999  
7001-9000  
E....  
2001-3000  
4001-5000  
S....  
2001-3000  
NE-11.P1  
FOR: NEIMAN ®

NSP....  
4000-4999  
7001-9000  
E....  
2001-3000  
4001-5000  
S....  
2001-3000  
NE-11.P2  
FOR: NEIMAN ®

NSP....  
4000-4999  
7001-9000  
E....  
2001-3000  
4001-5000  
S....  
2001-3000  
NE-24  
FOR: NEIMAN ®

NSP....  
4000-4999  
7001-9000  
E....  
2001-3000  
4001-5000  
S....  
2001-3000  
NE-24.P  
FOR: NEIMAN ®

NSP....  
4000-4999  
7001-9000  
E....  
2001-3000  
4001-5000  
S....  
2001-3000  
NE-24.P1  
FOR: NEIMAN ®

**FOR: LINCOLN ®**

FB-PB  
0000-1863  
FO-1

FO-3

AF  
0001-2600  
FA-PA  
0000-1863  
FO-2

FO-3D

A  
101-291  
501-579  
B  
101-332  
501-602  
C  
101-344  
501-624  
D  
101-327  
501-602  
E  
101-296  
501-579  
FA  
6500-7733  
FO-11D

FOR: FORD ®

39.6 mm

A  
101-291  
501-579  
B  
101-332  
501-602  
C  
101-344  
501-624  
D  
101-327  
501-602  
E  
101-296  
501-579  
FA  
6500-7733  
FO-20D

FOR: FORD ®

**FOR: LOTUS ®**

FOR: ASTON MARTIN ® AUTOBIANCHI ® DAIMLER ® FIAT ® JAGUAR ® JENSEN ® LOTUS ® PREMIER ® SEAT ® TRIUMPH ® YUGO ZASTAVA ®

SCANIA ®  
FK  
1-3040  
FO-FK

FR  
1-3040  
4001-6000  
FO-FR

FOR: FORD ®

Concerning the marks and commercial denominations see legal warning.  
Conceniende a las marcas y denominaciones comerciales ver aviso legal.  
Marka eta izendapen komertzialiei dagokienez, ikus lege-oharra.  
Concernant les marques et denominations commerciales voir la note dans l'index.



Beziehen auf die marke und handelsname sehen sie die notiz im Impressum.  
Relativamente às marcas e denominações comerciais, ver aviso legal.  
Jeśli chodzi o znaki i nazwy handlowe, patrz Informacje prawne.

FOR: LOTUS®

FOR:  
ASTON MARTIN®  
AUTOBIANCHI®  
DAIMLER®  
FIAT®  
JAGUAR®  
JENSEN®  
LOTUS®  
PREMIER®  
SEAT®  
TRIUMPH®  
YUGO ZASTAVA®  
SCANIA®

FR  
1-3040  
4001-6000

B  
000-999

D  
000-999

GM-10  
H  
000-999

GM-11  
K  
000-999

GM-10.P  
H  
000-999

GM-11.P  
K  
000-999

GM-B  
H  
000-999

GM-D  
K  
000-999

GM-B.P  
H  
000-999

GM-D.P  
K  
000-999

FO-FK.P  
FOR: FORD®

FO-FR.P  
FOR: G.M.®

GM-12  
H  
000-999

GM-13  
K  
000-999

GM-12.P  
H  
000-999

GM-13.P  
K  
000-999

GM-H  
H  
000-999

GM-K  
K  
000-999

GM-H.P  
H  
000-999

GM-K.P  
K  
000-999

FOR: ARMAN® -DOM® -JUGUDENT® -WASO®  
FOR: BRIGGS STRATTON®  
FOR: G.M.®  
FOR: BRIGGS STRATTON®  
FOR: G.M.®  
FOR: BRIGGS STRATTON®  
FOR: G.M.®  
FOR: BRIGGS STRATTON®  
FOR: G.M.®  
FOR: BRIGGS STRATTON®

FOR: LOTUS®

FOR:  
AUSTIN®  
CARBODIES®  
INNOCENTI®  
LAND ROVER®  
LOTUS®  
MASERATI®  
OM IVECO®  
ROVER®  
VAUXHALL®  
BEDFORD®  
FIAT IVECO®

RO  
BL...N  
1001-2000

LF-RO  
FOR: L. & F.®

FOR:  
AUSTIN®  
CARBODIES®  
INNOCENTI®  
LAND ROVER®  
LOTUS®  
MASERATI®  
OM IVECO®  
ROVER®  
VAUXHALL®  
BEDFORD®  
FIAT IVECO®

RO  
BL...N  
1001-2000

LF-RO.P  
FOR: L. & F.®

D  
1-5200

S....  
1-5200

OP-D  
FOR: HUF®

OP-S  
FOR: YMOS®

D  
1-5200

S....  
1-5200

OP-D.P  
FOR: HUF®

OP-S.P  
FOR: YMOS®

FOR: LOTUS®

K....  
001-400/1511-1910  
2221-2620/3731-4570  
5001-6368

R....  
401-800/1112-1510  
2621-3020/3331-3730  
5001-6924/8001-9368

S....  
5951-6350/7061-7460  
8171-8570/9281-9680

D....  
6001-7042

TOYO-K1  
FOR: TOYOTA®  
FOR: TOKAJ® -RIKA®

F....  
5951-6350  
7061-7460  
8171-8570  
9281-9680

P....  
7001-8500

TOYO-4  
FOR: TOYOTA®  
FOR: TOKAJ® -RIKA®

K....  
001-400/1511-1910  
2221-2620/3731-4570  
5001-6368

R....  
401-800/1112-1510  
2621-3020/3331-3730  
5001-6924/8001-9368

S....  
5951-6350/7061-7460  
8171-8570/9281-9680

D....  
6001-7042

TOYO-K1.P  
FOR: TOYOTA®  
FOR: TOKAJ® -RIKA®

F....  
5951-6350  
7061-7460  
8171-8570  
9281-9680

P....  
7001-8500

TOYO-4.P  
FOR: TOYOTA®  
FOR: TOKAJ® -RIKA®

C....  
6001-7042

UN-FK  
FOR: UNION®  
FOR: WBH®

FS....  
01-99  
876-955

UN-FS  
FOR: UNION®  
FOR: WBH®

FOR: LOTUS®

FT-BC...301-360  
BC-FT...101-225  
LF...451-575  
CB...801-875

UN-FT  
FOR: UNION®  
FOR: CEM®

TF  
TF...1001-1140

UN-TF  
FOR: CEM®

W...600-842

WAS-5  
FOR: WASO®

WAS-6  
FOR: WASO®

FOR: MACK®

A...201-1050  
C...500-699  
H...601-1100  
HM...201-1050

HUD-1  
FOR: HUDSON®

HUD-1D  
FOR: HUDSON®

C....  
250-499  
1701-1950

KEN-1  
FOR: KENWORTH®

KEN-1D  
FOR: KENWORTH®

FOR: BASCO® -BRIGGS&STRATTON® -YALE®

FOR: MAHINDRA®

TAT-2D.P  
FOR: TATA®

FOR: MARUTI®

MAR-1.P  
FOR: MARUTI®

16501-17704

SUZU-7  
FOR: SUZUKI®

16501-17704

SUZU-7.P  
FOR: SUZUKI®

SUZU-7D.P  
FOR: SUZUKI®

FOR: MASERATI®

FOR:  
CROMODORA®  
FIST®  
FREA®  
GIOBERT®  
MIRAGLIO®  
RUFFINI®

A  
0501-3278  
0,4,6,8,9

AF-71  
FOR: SAFE®

AF-7D  
FOR: SAFE®

6  
100-309

AF-51  
FOR: SAFE®

8  
100-309

AF-5D  
FOR: SAFE®

H  
01-78

AF-81  
FOR: SAFE®

G  
01-78

AF-8D  
FOR: SAFE®

2  
100-309

AF-61  
FOR: SAFE®

4  
100-309

AF-6D  
FOR: SAFE®

F  
01-78

AF-91  
FOR: SAFE®

E  
01-78

AF-9D  
FOR: SAFE®

FOR: SIPEA®  
FOR: SAFE®

FOR: MASERATI®

A  
0501-3278  
0,4,6,8,9

AF-71.P  
FOR: SIPEA®  
FOR: SAFE®

H  
01-78

AF-81.P  
FOR: SIPEA®  
FOR: SAFE®

G  
01-78

AF-8D.P  
FOR: SIPEA®  
FOR: SAFE®

E  
01-78

AF-9D.P  
FOR: SIPEA®  
FOR: SAFE®

A  
0501-3278  
0,4,6,8,9

AF-71.P1  
FOR: SIPEA®  
FOR: NEIMAN®

1  
100-789

AF-10  
FOR: SAFE®

3  
100-789

AF-11  
FOR: SAFE®

5  
100-789

AF-12  
FOR: SAFE®

B-T....T  
1 AL 7

CT-3  
FOR: SIMPLEX®  
FOR: NEIMAN® -VACHETTE®

B-T....T  
1 AL 7

CT-3.P  
FOR: SIMPLEX®  
FOR: NEIMAN® -VACHETTE®

Concerning the marks and commercial denominations see legal warning.  
Concerniente a las marcas y denominaciones comerciales ver aviso legal.  
Marka eta izendapen komertzialiei dagokienez, ikus lege-oharra.  
Concernant les marques et denominations commerciales voir la note dans l'index.



FOR: MASERATI®

AF  
0001-2600  
FA-PA  
0000-1863  
FO-2  
FOR: FORD®

GIOB-1D  
FOR: GIOBERT®

GIOB-21.P  
FOR: GIOBERT®

IMS-3  
0501-1000  
IMS-5  
0501-1000  
IMS-13  
FOR: SAFE®  
FOR: CROMODORA® -FIST® -IMS®

AF-21  
0501-1000  
AF-19  
0501-1000  
IMS-3.P  
0501-1000  
IMS-5.P  
0501-1000  
IMS-13.P  
FOR: SAFE®  
FOR: CROMODORA® -FIST® -IMS®

FOR: MASERATI®

FOR:  
AUSTIN®  
CARBODIES®  
INNOCENTI®  
LAND ROVER®  
LOTUS®  
MASERATI®  
OM IVECO®  
ROVER®  
VAUXHALL®  
BEDFORD®  
FIAT IVECO®

RO  
BL...N  
1001-2000  
LF-RO  
FOR: L. & F.®

FOR:  
AUSTIN®  
CARBODIES®  
INNOCENTI®  
LAND ROVER®  
LOTUS®  
MASERATI®  
OM IVECO®  
ROVER®  
VAUXHALL®  
BEDFORD®  
FIAT IVECO®

RO  
BL...N  
1001-2000  
LF-RO.P  
FOR: L. & F.®

C4..AA-ZY  
D4..AA-HR  
RO-5I  
FOR: RONIS®  
FOR: ABSA®

C3..AA-ZY  
D3..AA-HR  
J...1-544  
RO-5D  
FOR: RONIS®  
FOR: ABSA®

FOR: MAZDA®

.....  
.....A/Z  
B-C-D-E  
1/9...A/Z  
1/9...A/Z  
.....A/Z  
B-D-E-G-H-J  
.1/9...A/Z  
.1/9...A/Z  
E-M-N-P-R  
CHR-3  
FOR: CHRYSLER®  
FOR: CLAUSSOR® -NEIMAN®

001-150  
601-900  
3-7  
DAT-3I  
001-150  
601-900  
1-5  
DAT-4I  
FOR: NISSAN®  
FOR: DATSUN®

001-150  
601-900  
4-8  
DAT-3D  
001-150  
601-900  
6-9  
DAT-4D  
FOR: NISSAN®  
FOR: DATSUN®

FOR: MAZDA®

VH  
0001-3948  
K  
00001-14000  
DAT-11  
FOR: NISSAN®  
FOR: DATSUN® -WASO®

VH  
0001-3948  
K  
00001-14000  
DAT-11D  
FOR: NISSAN®  
FOR: DATSUN® -WASO®

VH  
0001-3948  
K  
00001-14000  
DAT-11.P  
FOR: NISSAN®  
FOR: DATSUN® -WASO®

T  
1 AL 4  
T  
0001-1050  
FO-6.P  
FOR: FORD®  
FOR: HUF®

2000-2499  
MAZ-1I  
FOR: MAZDA®

1500-1999  
5000-6100  
MAZ-1D  
FOR: MAZDA®

3000-3499  
5000-6100  
MAZ-2I  
FOR: MAZDA®

2500-2999  
3500-4600  
MAZ-2D  
FOR: MAZDA®

FOR: MAZDA®

3000-3499  
5000-6100  
MAZ-2I.P  
FOR: MAZDA®

2500-2999  
3500-4600  
MAZ-2D.P  
FOR: MAZDA®

6500-7733  
MAZ-3I  
FOR: MAZDA®

6500-7733  
MAZ-3D  
FOR: MAZDA®

MAZ-3I.P  
FOR: MAZDA®

6500-7733  
MAZ-3D.P  
FOR: MAZDA®

MAZ-4  
FOR: MAZDA®

MAZ-4.P  
FOR: MAZDA®

FOR: MAZDA®

FA...  
6500-7733  
MAZ-5D  
FOR: MAZDA®

FA...  
6500-7733  
MAZ-5D.P  
FOR: MAZDA®

.....  
6500-7733  
MAZ-6  
FOR: MAZDA®

.....  
6500-7733  
MAZ-6D  
FOR: MAZDA®

MAZ-6.P  
FOR: MAZDA®

6500-7733  
MAZ-6D.P  
FOR: MAZDA®

.....  
10100-12099  
MAZ-7D  
FOR: MAZDA®

FOR: MAZDA®

.....  
10100-12099  
MAZ-7D.P  
FOR: MAZDA®

.....  
10100-12099  
MAZ-7D.P1  
FOR: MAZDA®

.....A...  
101-291  
501-579  
...B...  
101-332  
501-602  
...C...  
101-344  
501-624  
...D...  
101-327  
501-602  
...E...  
101-296  
501-579  
MAZ-8D  
FOR: MAZDA®

.....A...  
101-291  
501-579  
...B...  
101-332  
501-602  
...C...  
101-344  
501-624  
...D...  
101-327  
501-602  
...E...  
101-296  
501-579  
MAZ-8D.P  
FOR: MAZDA®

.....  
10100-12099  
MAZ-11D  
FOR: MAZDA®

Concerning the marks and commercial denominations see legal warning.  
Concieniente a las marcas y denominaciones comerciales ver aviso legal.  
Marka eta izendapen komertzialiei dagokienez, ikus lege-oharra.  
Concernant les marques et denominations commerciales voir la note dans l'index.

FOR: MAZDA®



FOR: MERCEDES®

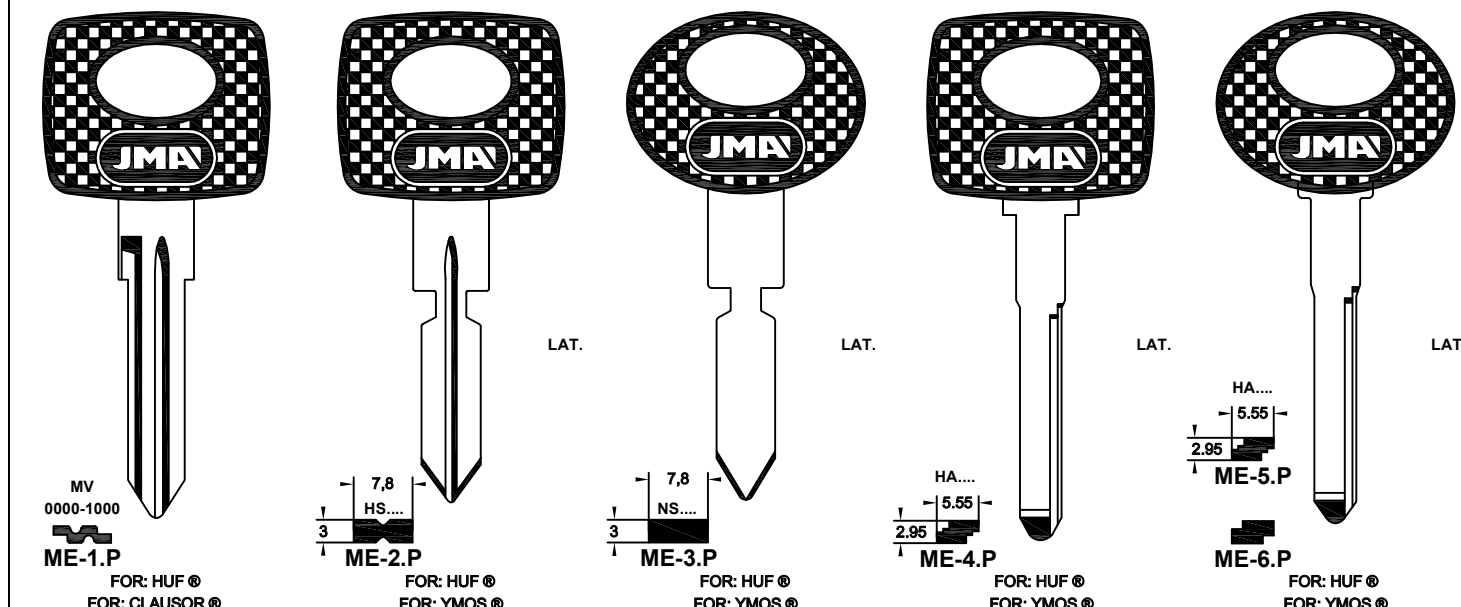

FOR: MAZDA®

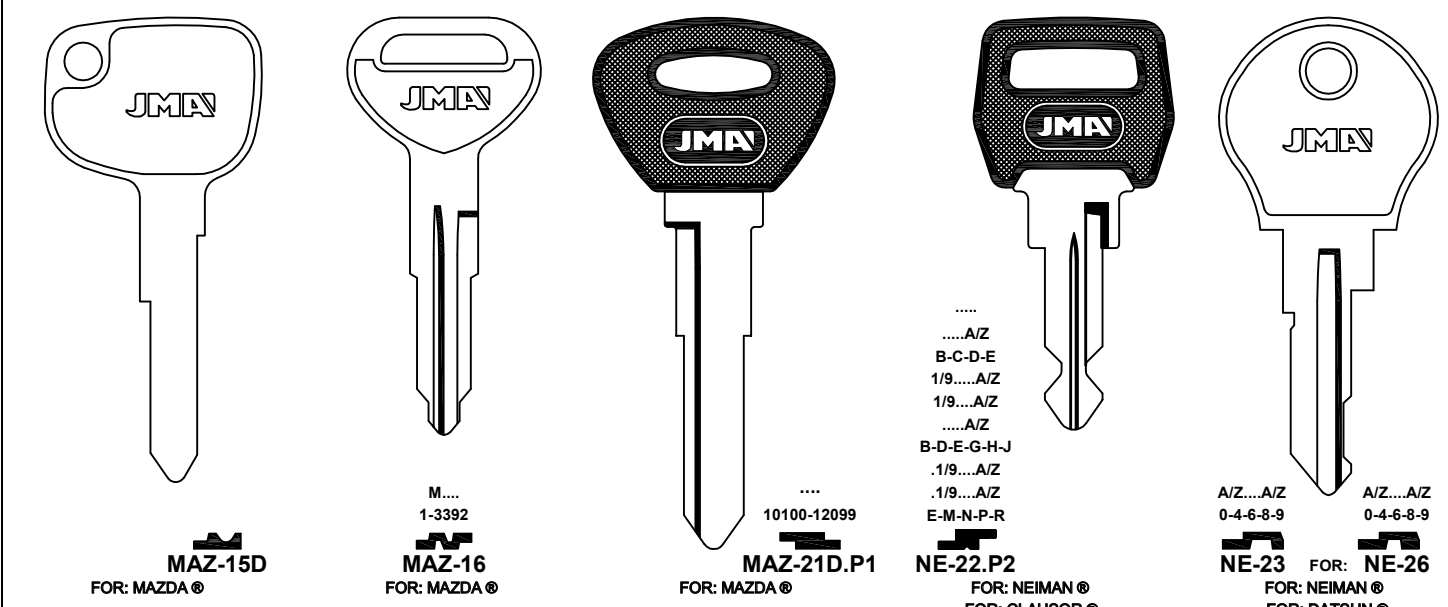

FOR: MERCEDES®

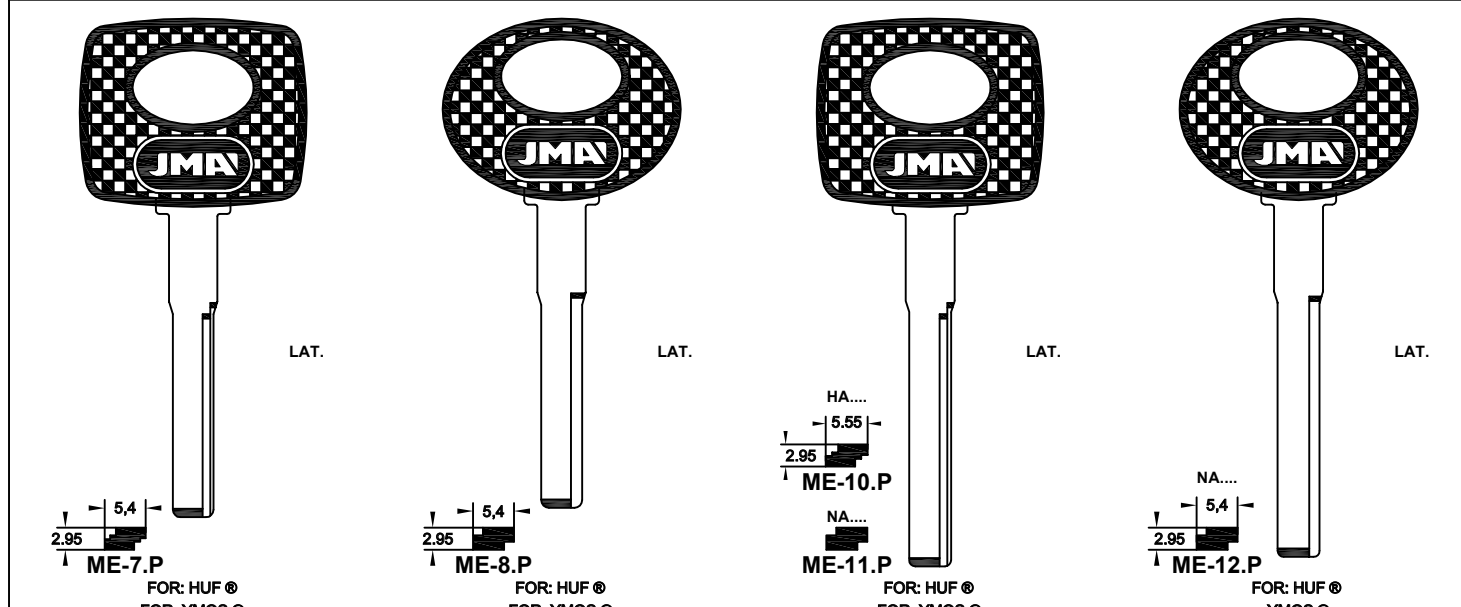

FOR: MAZDA®

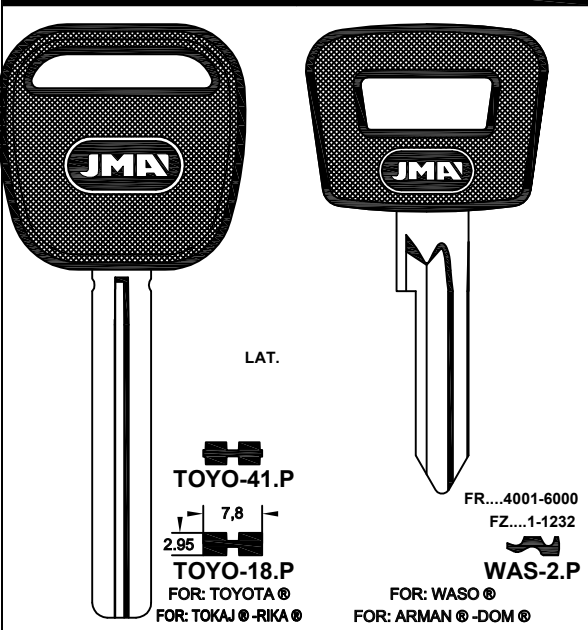

FOR: MERCEDES®

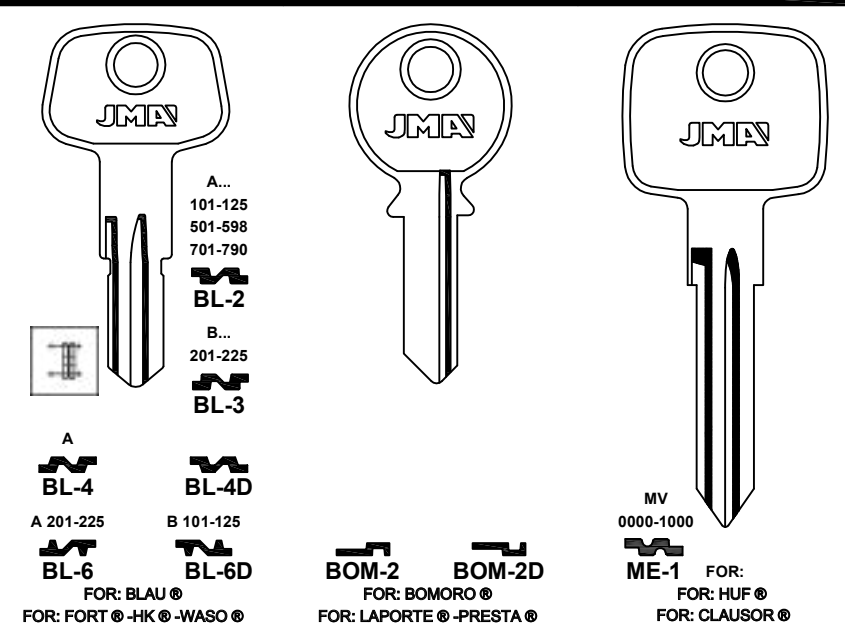

FOR: MERCEDES®

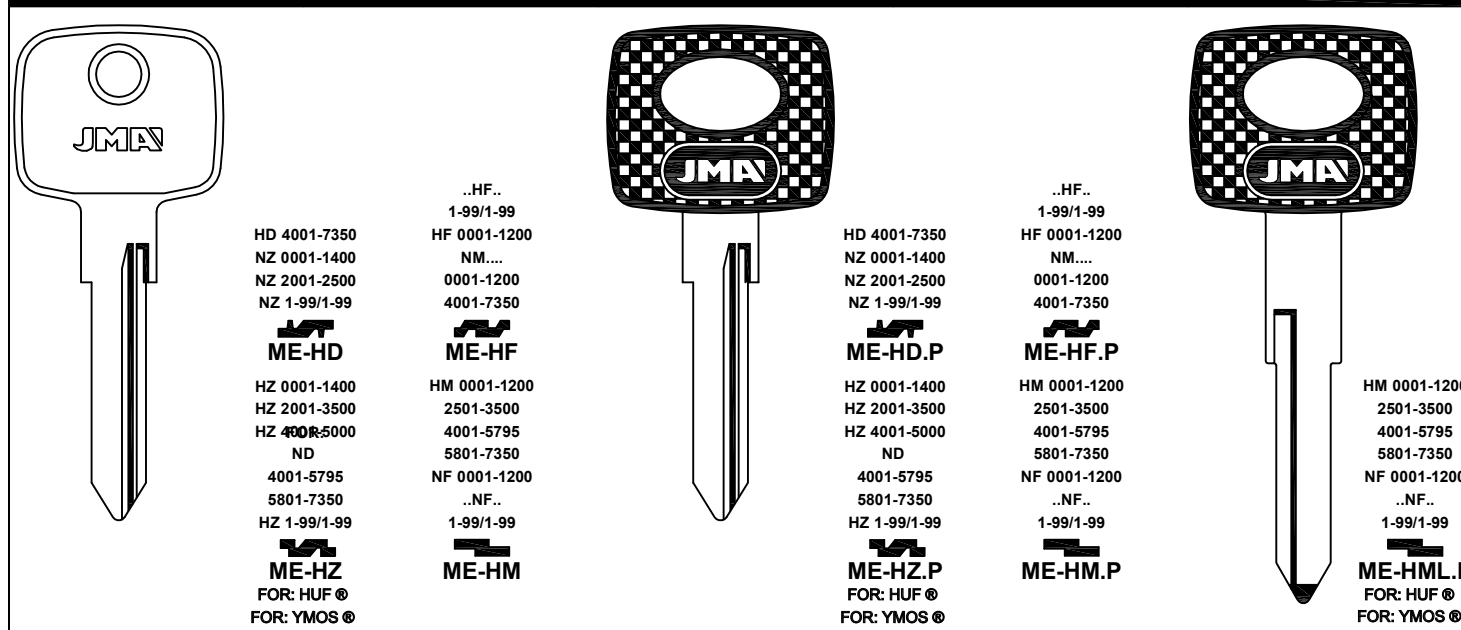

Concerning the marks and commercial denominations see legal warning.  
 Concerniente a las marcas y denominaciones comerciales ver aviso legal.  
 Marka eta izendapen komertzialiei dagokienez, ikus lege-oharra.  
 Concernant les marques et denominations commerciales voir la note dans l'index.



Beziehen auf die marke und handelsname sehen sie die notiz im Impressum.  
 Relativamente às marcas e denominações comerciais, ver aviso legal.  
 Jeśli chodzi o znaki i nazwy handlowe, patrz Informacje prawne.

FOR: MERCEDES®

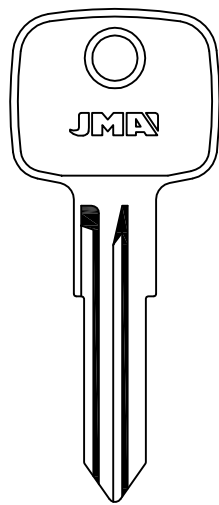

HU  
6001-8130



ME-HU

NU  
6001-8130



ME-NU

FOR: HUF®  
FOR: YMOS®

HY  
6001-8130



ME-HY

NY  
6001-8130



ME-NY

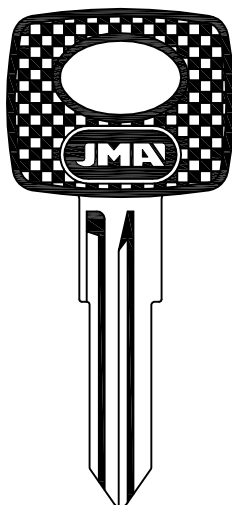

HU  
6001-8130



ME-HU.P

NU  
6001-8130



ME-NU.P

FOR: HUF®  
FOR: YMOS®

HY  
6001-8130



ME-HY.P

NY  
6001-8130



ME-NY.P

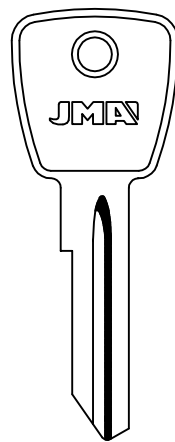

L  
001-300



ME-L

FOR: HUF®  
FOR: IMSA® -YMOS®

FOR: MERCURY®

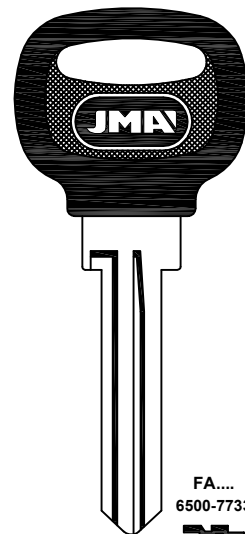

FA....  
6500-7733



FO-14D.P

FOR: FORD®

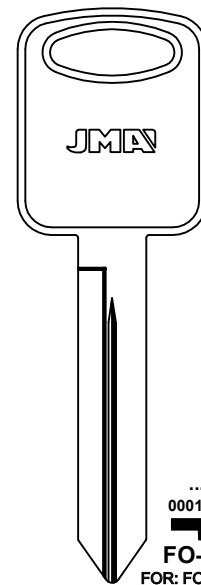

....X  
0001-1706



FO-15D

FOR: FORD®

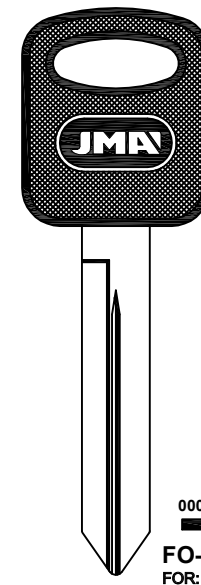

....X  
0001-1706



FO-15D.P

FOR: FORD®

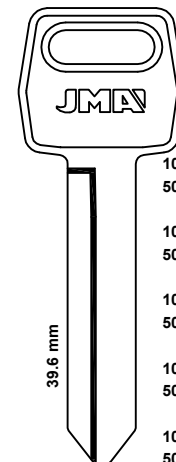

39.6 mm

A  
101-291  
501-579  
B  
101-332  
501-602  
C  
101-344  
501-624  
D  
101-327  
501-602  
E  
101-296  
501-579  
FA  
6500-7733



FO-20D

FOR: FORD®

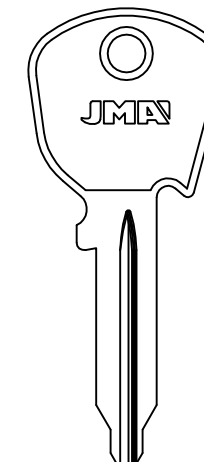

B-D-DV  
01-64



FO-D

FOR: FORD®  
FOR: BRITAX® -KOLB®

FOR: MERCEDES®

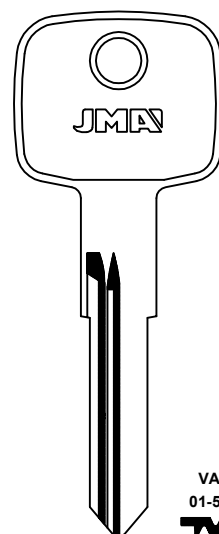

VA  
01-50



ME-VA

FOR: HUF®  
FOR: CASI®

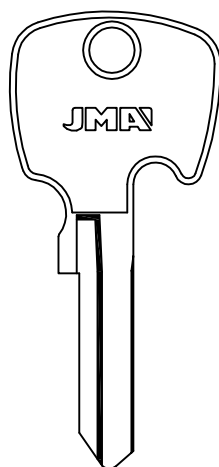

D...  
1-2-3-4-5



NE-61D

FOR: NEIMAN®

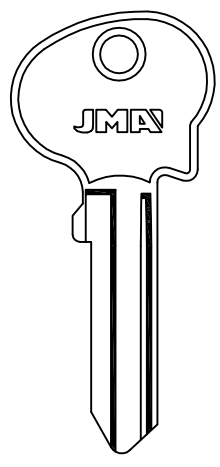

8...  
1-2-3-4-5



NE-62

FOR: NEIMAN®

LAT.

FOR: MERCURY®

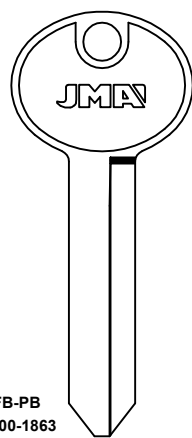

FB-PB  
0000-1863



FO-1



FO-3

FOR: FORD®

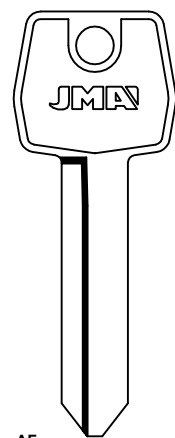

AF  
0001-2600  
FA-PA  
0000-1863



FO-2

FOR: FORD®

FOR: MERCURY®

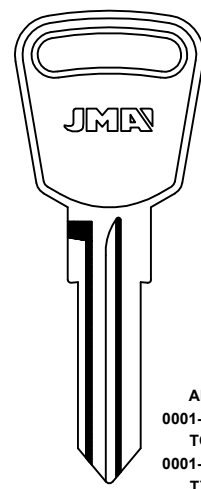

AK  
0001-1000  
TC  
0001-1000  
TX  
0001-1859



FO-E/TC

FOR: FORD®  
FOR: CASI® -CEM® -CLAUSOR® -KOLB® -NEIMAN®

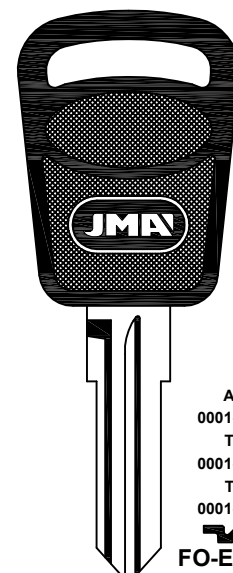

AK  
0001-1000  
TC  
0001-1000  
TX  
0001-1859



FO-E/TC.P

FOR: FORD®

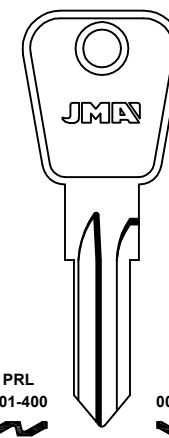

PRL  
001-400



FO-PRL

FOR: FORD®

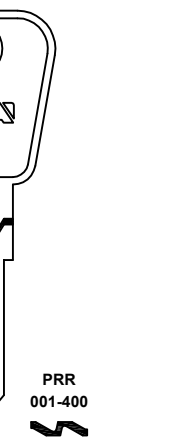

PRR  
001-400



FO-PRR

FOR: FORD®

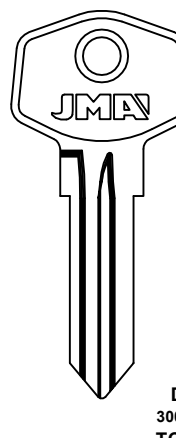

DM  
300-400  
TC-AK  
0001-1000  
TX  
0001-1859



FO-TC

FOR: FORD®  
FOR: CASI® -CEM® -KOLB®

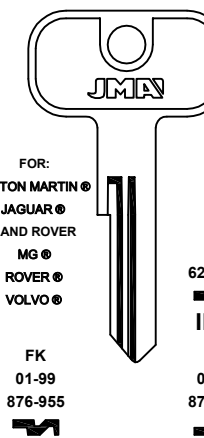

FOR:  
ASTON MARTIN®  
JAGUAR®  
LAND ROVER  
MG®  
ROVER®  
VOLVO®

FP  
626-750



IN-1

FS  
01-99  
876-955



IN-4

FR  
51-875



JN-4

FOR: UNION®

FOR: MERCURY®

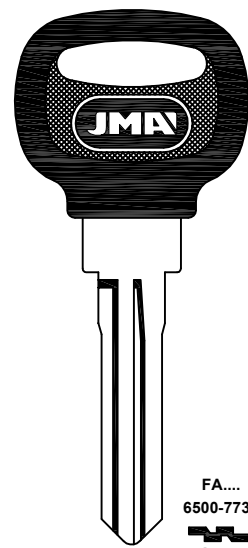

FA....  
6500-7733



FO-7.P

FOR: FORD®

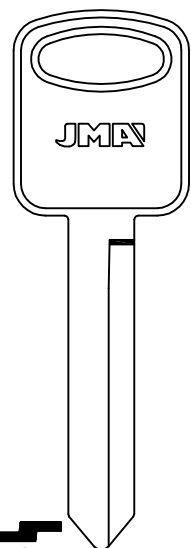

FO-8



FO-8D

FOR: FORD®

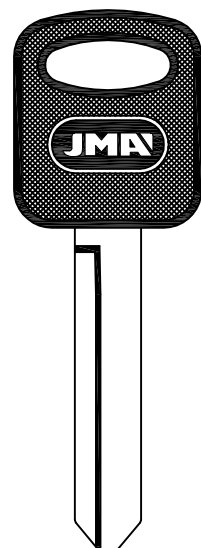

A  
101-291  
501-579  
B  
101-332  
501-602  
C  
101-344  
501-624  
D  
101-327  
501-602  
E  
101-296  
501-579



FO-8D

FOR: FORD®

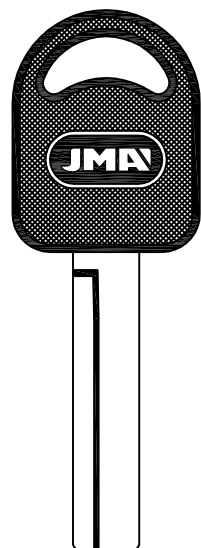

A  
101-291  
501-579  
B  
101-332  
501-602  
C  
101-344  
501-624  
D  
101-327  
501-602  
E  
101-296  
501-579



FO-8D.P1

FOR: FORD®

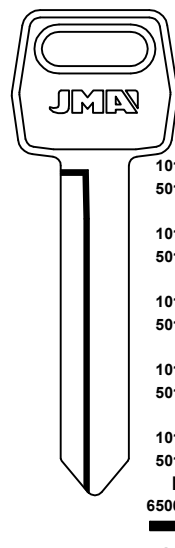

A  
101-291  
501-579  
B  
101-332  
501-602  
C  
101-344  
501-624  
D  
101-327  
501-602  
E  
101-296  
501-579  
FA  
6500-7733

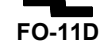

FO-11D

FOR: FORD®

FOR: MG®

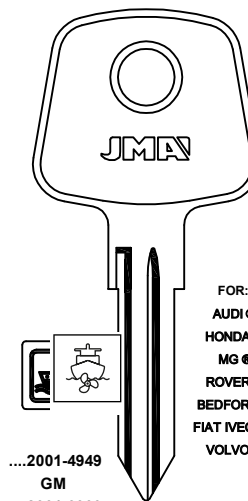

....2001-4949  
GM



NE-1

FOR: NEIMAN®

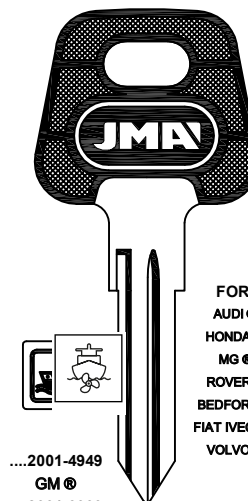

....2001-4949  
GM



NE-1.P

FOR: NEIMAN®

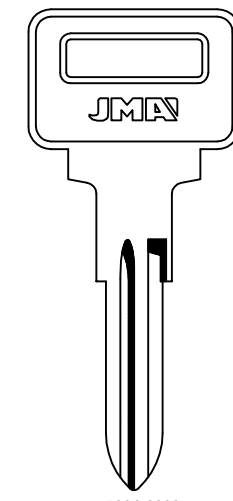

....7001-9000



NE-10

FOR: NEIMAN®

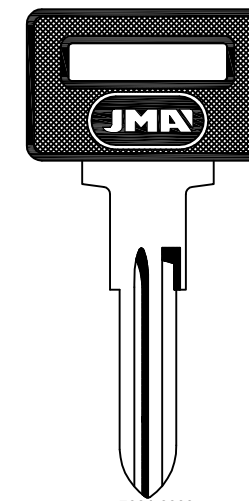

....7001-9000



NE-10.P

FOR: NEIMAN®

Concerning the marks and commercial denominations see legal warning.  
Concerniente a las marcas y denominaciones comerciales ver aviso legal.  
Marka eta izendapen komertzialiei dagokienez, ikus lege-oharra.  
Concernant les marques et denominations commerciales voir la note dans l'index.

**JMA** Opening the future

**JMA** Opening the future

Beziehen auf die marke und handelsname sehen sie die notiz im Impressum.  
Relativamente às marcas e denominações comerciais, ver aviso legal.  
Jeśli chodzi o znaki i nazwy handlowe, patrz Informacje prawne.





FOR: MG®

NRA  
FFE...1-100  
FJA...1-100  
FL...251-500  
NRA...51-90  
YFB...1-75  
FMD...1-75  
FG...1-30  
NF...1-30  
EJR...1-75

FP...  
626-750

UN-FFE  
UN-3  
UN-FP

MC...1-40  
MRA...251-290  
MRN...1-54  
MRN...201-250  
MRN...251-300

FR...  
751-875

UN-MRN  
UN-2  
UN-FR

FS...1-99  
FS...876-955

FA...  
501-625

RM...  
911-952

NGN...1-54

UN-1FS  
UN-44  
UN-44D  
UN-NG

FOR: UNION®

FK...  
01-99  
876-955

FS...  
01-99  
876-955

UN-FK  
UN-FS

FOR: UNION®  
FOR: WBH®

FT-BC...301-360  
BC-FT...101-225  
LF...451-575  
CB...801-875

TF...1001-1140

UN-FT  
UN-TF

FOR: UNION®  
FOR: CEM®

NH...  
2001-3000

UN-NH

FOR: UNION®  
FOR: CEM®

FOR: MITSUBISHI®

H  
7001-8400  
MIT-4  
FOR: MITSUBISHI®

H  
7001-8400  
MIT-4.P  
FOR: MITSUBISHI®

H  
7001-9000  
MIT-5  
FOR: MITSUBISHI®

H  
7001-9000  
MIT-5.P  
FOR: MITSUBISHI®

H  
7001-9000  
MIT-6  
FOR: MITSUBISHI®

FOR: MICROCAR®

0111111  
AL  
628888

SIX-3.P  
FOR: SIMPLEX®

FOR: MITSUBISHI®

E...  
5001-7679

CHR-17  
FOR: CHRYSLER®

Y  
1001-2000

HY-3

X  
1001-2000

HY-3D  
FOR: HYUNDAI®

X  
1001-2000

HY-3D.P1  
FOR: HYUNDAI®

E  
2001-3000

MIT-11  
FOR: MITSUBISHI®

H  
001-400  
2221-2620  
4441-4640  
4641-5143

E  
2001-3000

MIT-1D  
FOR: MITSUBISHI®

FOR: MITSUBISHI®

H  
7001-9000  
MIT-6.P  
FOR: MITSUBISHI®

E  
5001-7000  
MIT-7  
FOR: MITSUBISHI®

E  
5001-7000  
7001-7679

MIT-15.P  
FOR: MITSUBISHI®

30010-32009

MIT-8D  
FOR: MITSUBISHI®

30010-32009

MIT-8D.P  
FOR: MITSUBISHI®

FOR: MITSUBISHI®

H  
001-400  
2221-2620  
4441-4640  
4641-5143

E  
2001-3000

MIT-11.P  
FOR: MITSUBISHI®

H  
001-400  
2221-2620  
4441-4640  
4641-5143

E  
2001-3000

MIT-1D.P  
FOR: MITSUBISHI®

H  
001-400  
2221-2620  
4441-4640  
4641-5143

E  
2001-3000

MIT-21  
FOR: MITSUBISHI®

H  
001-400  
2221-2620  
4441-4640  
4641-5143

E  
2001-3000

MIT-2D  
FOR: MITSUBISHI®

H  
001-400  
2221-2620  
4441-4640  
4641-5143

E  
2001-3000

MIT-21.P  
FOR: MITSUBISHI®

H  
001-400  
2221-2620  
4441-4640  
4641-5143

E  
2001-3000

MIT-2D.P  
FOR: MITSUBISHI®

H  
7001-8400

MIT-3  
FOR: MITSUBISHI®

H  
7001-8400

MIT-3.P  
FOR: MITSUBISHI®

FOR: MITSUBISHI®

30010-32009

MIT-8D.P2  
FOR: MITSUBISHI®

E  
5001-7679

MIT-12  
FOR: MITSUBISHI®

30010-32009

MIT-13D  
FOR: MITSUBISHI®

30010-32009

MIT-14D  
FOR: MITSUBISHI®

FOR: MOSKVITCH®

0 AL 3  
LA-3D  
FOR: LADA-MOSKVITCH®

Concerning the marks and commercial denominations see legal warning.  
Conceniende a las marcas y denominaciones comerciales ver aviso legal.  
Marka eta izendapen komertzialiei dagokienez, ikus lege-oharra.  
Concernant les marques et denominations commerciales voir la note dans l'index.

**JMA** Opening the future

**JMA** Opening the future

Beziehen auf die Marke und Handelsname sehen Sie die Notiz im Impressum.  
Relativamente às marcas e denominações comerciais, ver aviso legal.  
Jeśli chodzi o znaki i nazwy handlowe, patrz Informacje prawne.



FOR: MOSKVITCH®

.....  
0 AL 3  
LA-3D.P  
FOR: LADA-MOSKVITCH®

JMA  
MOS-1  
FOR: MOSKVITCH®

.....A/Z  
A/Z.....  
A/Z.....A/Z  
1 AL 7  
.....A/Z  
0 AL 9  
NE-3  
FOR: NEIMAN®  
FOR: CLAUSOR®

FOR:  
EBRO®  
FIAT®  
LADA VAZ®  
MOSKVITCH®  
PEUGEOT®  
RENAULT®  
TALBOT SIMCA®  
ZAZ®  
DAF®  
VOLVO®

.....A/Z  
A/Z.....  
A/Z.....A/Z  
1 AL 7  
.....A/Z  
0 AL 9  
NE-3.P  
FOR: NEIMAN®  
FOR: CLAUSOR®

FOR:  
EBRO®  
FIAT®  
LADA VAZ®  
MOSKVITCH®  
PEUGEOT®  
RENAULT®  
TALBOT SIMCA®  
ZAZ®  
DAF®  
VOLVO®

.....A/Z  
A/Z.....  
A/Z.....A/Z  
1 AL 7  
.....A/Z  
0 AL 9  
NE-3.P1  
FOR: NEIMAN®  
FOR: CLAUSOR®

FOR: NISSAN®

EBRO®  
FIAT®  
LADA VAZ®  
MOSKVITCH®  
PEUGEOT®  
RENAULT®  
TALBOT SIMCA®  
ZAZ®  
DAF®  
VOLVO®

.....A/Z  
A/Z.....  
A/Z.....A/Z  
1 AL 7  
.....A/Z  
0 AL 9  
NE-3.P2  
FOR: NEIMAN®  
FOR: CLAUSOR®

JMA  
VOL-2  
VOL-2D

JMA  
VOL-3  
FOR: VOLGA®  
FOR: GAZ®-ZAZ®

F  
0001-1000  
1001-2000  
M  
4001-5000  
DAT-11

M  
0001-1000  
5001-6000  
N  
1001-2000  
DAT-1D

M  
6001-7000  
W  
0001-1000  
DAT-21

M  
0001-1000  
5001-6000  
N  
1001-2000  
DAT-1D

M  
7001-8000  
M  
7001-800  
DAT-2D

FOR: NISSAN®  
FOR: DATSUN®-WASO®

FOR: NISSAN®

F  
0001-1000  
1001-2000  
M  
4001-5000  
DAT-11.P

M  
0001-1000  
5001-6000  
N  
1001-2000  
DAT-1D.P

M  
6001-7000  
W  
0001-1000  
DAT-21.P

M  
7001-8000  
M  
7001-800  
DAT-2D.P

FOR: NISSAN®  
FOR: DATSUN®-WASO®

001-150  
601-900  
3-7  
DAT-31

001-150  
601-900  
4-8  
DAT-3D

001-150  
601-900  
1-5  
DAT-41

001-150  
601-900  
6-9  
DAT-4D

VH  
0001-3948  
K  
00001-14000  
DAT-5D

FOR: NISSAN®  
FOR: DATSUN®

FOR: NISSAN®  
FOR: DATSUN®-WASO®

FOR: NISSAN®

X  
0001-8000  
DAT-6  
FOR: NISSAN®  
FOR: DATSUN®

DAT-6D

X  
0001-8000  
DAT-6.P  
FOR: NISSAN®  
FOR: DATSUN®

DAT-6D.P

Y  
0001-8000  
8001-9000  
DAT-7  
FOR: NISSAN®  
FOR: DATSUN®

X  
0001-8000  
DAT-7.P  
FOR: NISSAN®  
FOR: DATSUN®

FOR: NISSAN®

X  
0001-8000  
DAT-6.P1

Y  
0001-8000  
8001-9000  
DAT-7.P1

FOR: NISSAN®  
FOR: DATSUN®

DAT-6D.P1

F  
0001-1000  
1001-2000  
M  
4001-5000  
DAT-81

M  
0001-1000  
5001-6000  
N  
1001-2000  
DAT-8

M  
6001-7000  
7001-800  
W  
0001-1000  
DAT-91

M  
7001-800  
DAT-9D

F  
0001-1000  
1001-2000  
M  
4001-5000  
DAT-81.P1

FOR: NISSAN®  
FOR: DATSUN®

FOR: NISSAN®  
FOR: DATSUN®

FOR: NISSAN®  
FOR: DATSUN®

FOR: NISSAN®

F  
0001-1000  
1001-2000  
M  
4001-5000  
DAT-81.P

M  
0001-1000  
5001-6000  
N  
1001-2000  
DAT-8.P

M  
6001-7000  
7001-800  
W  
0001-1000  
DAT-91.P

M  
7001-800  
DAT-9D.P

X  
0001-9000  
DAT-10  
FOR: NISSAN®

X  
0001-9000  
DAT-10.P  
FOR: NISSAN®

VH  
0001-3948  
K  
00001-14000  
DAT-11  
FOR: NISSAN®

DAT-11D  
FOR: DATSUN®-WASO®

FOR: NISSAN®  
FOR: DATSUN®

FOR: NISSAN®  
FOR: DATSUN®

Concerning the marks and commercial denominations see legal warning.  
 Concerniente a las marcas y denominaciones comerciales ver aviso legal.  
 Marka eta izendapen komertzialiei dagokienez, ikus lege-oharra.  
 Concernant les marques et denominations commerciales voir la note dans l'index.

**JMA** Opening the future

**JMA** Opening the future

Beziehen auf die marke und handelsname sehen sie die notiz im Impressum.  
 Relativamente às marcas e denominações comerciais, ver aviso legal.  
 Jeśli chodzi o znaki i nazwy handlowe, patrz Informacje prawne.



FOR: NISSAN®

VH  
0001-3948  
K  
00001-14000  
DAT-11.P  
FOR: NISSAN®  
FOR: DATSUN® -WASO®

X  
0001-9000  
DAT-12  
FOR: NISSAN®

Y  
....1-8000  
DAT-13  
FOR: NISSAN®

Y  
....1-8000  
DAT-14.P  
FOR: NISSAN®

1-22185  
DAT-15  
FOR: NISSAN®

FOR: NISSAN®

1-22185  
DAT-15.P  
FOR: NISSAN®

....1-22185  
DAT-15.P4  
FOR: NISSAN®

1-22185  
DAT-16  
FOR: NISSAN®

DAT-17  
FOR: NISSAN®

DAT-17D  
FOR: NISSAN®

DAT-18  
FOR: NISSAN®

LAT.

FOR: NISSAN®

A  
101-291  
501-579  
B  
101-332  
501-602  
C  
101-344  
501-624  
D  
101-327  
501-602  
E  
101-296  
501-579  
DAT-19.P  
FOR: NISSAN®

....X  
0001-1706  
DAT-20  
FOR: NISSAN®

....X  
0001-1706  
DAT-20.P  
FOR: NISSAN®

FO-8  
FOR: FORD®

A  
101-291  
501-579  
B  
101-332  
501-602  
C  
101-344  
501-624  
D  
101-327  
501-602  
E  
101-296  
501-579  
FO-8D  
FOR: FORD®

A  
101-291  
501-579  
B  
101-332  
501-602  
C  
101-344  
501-624  
D  
101-327  
501-602  
E  
101-296  
501-579  
FO-8D.P  
FOR: FORD®

FOR: NISSAN®

A  
101-291  
501-579  
B  
101-332  
501-602  
C  
101-344  
501-624  
D  
101-327  
501-602  
E  
101-296  
501-579  
FO-8D.P1  
FOR: FORD®

NSP....  
4000-4999  
7001-9000  
E....  
2001-3000  
4001-5000  
S....  
2001-3000  
NE-11  
FOR: NEIMAN®

NSP....  
4000-4999  
7001-9000  
E....  
2001-3000  
4001-5000  
S....  
2001-3000  
NE-11.P  
FOR: NEIMAN®

FOR: NISSAN (AUSTRALIA)®

X  
0001-8000  
DAT-6  
FOR: NISSAN®

Y  
0001-8000  
8001-9000  
DAT-7  
FOR: DATSUN®

DAT-6D  
FOR: DATSUN®

FOR: NISSAN (AUSTRALIA)®

X  
0001-8000  
DAT-6.P  
FOR: NISSAN®

Y  
0001-8000  
8001-9000  
DAT-7.P  
FOR: DATSUN®

DAT-6D.P  
FOR: NISSAN®

X  
0001-9000  
DAT-12  
FOR: NISSAN®

FOR: NISSAN (USA)®

F  
0001-1000  
1001-2000  
M  
4001-5000  
DAT-11  
FOR: NISSAN®

M  
0001-1000  
5001-6000  
N  
1001-2000  
DAT-1D  
FOR: NISSAN®

M  
6001-7000  
W  
0001-1000  
DAT-21  
FOR: DATSUN® -WASO®

M  
0001-8000  
7001-8000  
DAT-2D  
FOR: DATSUN® -WASO®

FOR: NISSAN (USA)®

F  
0001-1000  
1001-2000  
M  
4001-5000  
DAT-11.P  
FOR: NISSAN®

M  
0001-1000  
5001-6000  
N  
1001-2000  
DAT-1D.P  
FOR: NISSAN®

M  
6001-7000  
W  
0001-1000  
DAT-21.P  
FOR: DATSUN® -WASO®

M  
0001-8000  
7001-8000  
DAT-2D.P  
FOR: DATSUN® -WASO®

X  
0001-8000  
DAT-6  
FOR: NISSAN®

Y  
0001-8000  
8001-9000  
DAT-7  
FOR: DATSUN®

DAT-6D  
FOR: DATSUN®

Concerning the marks and commercial denominations see legal warning.  
Concerniente a las marcas y denominaciones comerciales ver aviso legal.  
Marka eta izendapen komertzialiei dagokienez, ikus lege-oharra.  
Concernant les marques et dénominations commerciales voir la note dans l'index.

**JMA**® Opening the future

**JMA**® Opening the future

Beziehen auf die Marke und Handelsname sehen Sie die Notiz im Impressum.  
Relativamente às marcas e denominações comerciais, ver aviso legal.  
Jeśli chodzi o znaki i nazwy handlowe, patrz Informacje prawne.



FOR: NISSAN (USA)®

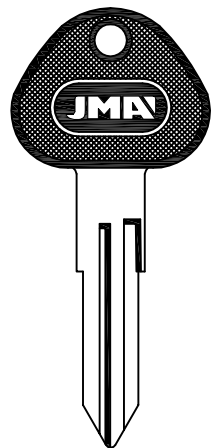

X  
0001-8000  
DAT-6.P DAT-6D.P

Y  
0001-8000  
8001-9000  
DAT-7.P

FOR: NISSAN®  
FOR: DATSUN®

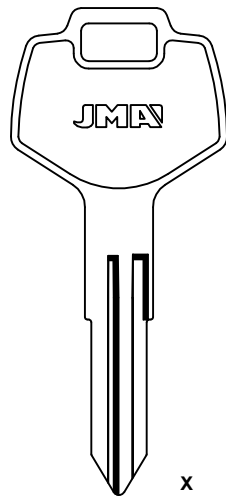

X  
0001-9000  
DAT-12

FOR: NISSAN®

FOR: NSU®

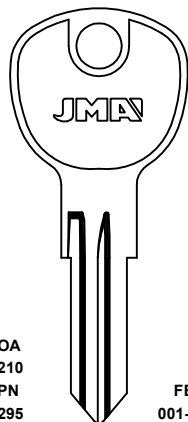

DA-OA  
001-210  
ER-PN  
101-295  
ER  
001-195  
ER  
501-695  
FO-OA

FB  
001-210  
PO  
501-695  
PO  
101-295  
FO-PN

FOR: FORD®  
FOR: CASI® -HUF® -YMOS®

OL  
001-210  
07R  
001-195  
7OR  
001-210  
FO-OL

O7L  
001-195  
7OL  
001-210  
OR  
001-210  
FO-OR

FOR: CASI® -YMOS®

OB...  
1-210  
VO-7

FOR: OM IVECO®

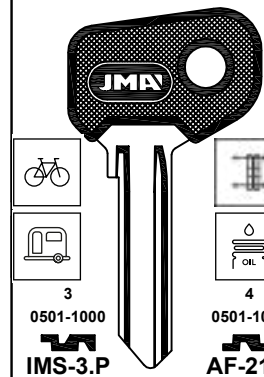

3  
0501-1000  
IMS-3.P

4  
0501-1000  
AF-21.P

1  
0501-1000  
IMS-5.P

2  
0501-1000  
AF-19.P

IMS-13.P

FOR: SAFE®  
FOR: CROMODORA® -FIST® -IMSA®

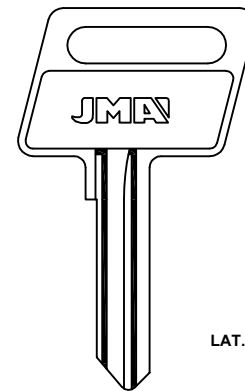

LAT.

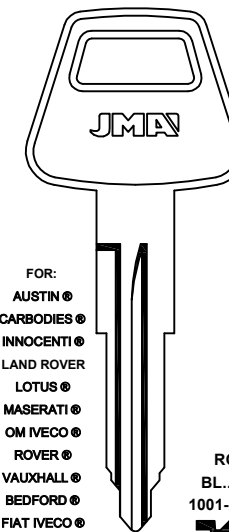

FOR:  
AUSTIN®  
CARBODIES®  
INNOCENTI®  
LAND ROVER  
LOTUS®  
MASERATI®  
OM IVECO®  
ROVER®  
VAUXHALL®  
BEDFORD®  
FIAT IVECO®

FOR: L. & F.®

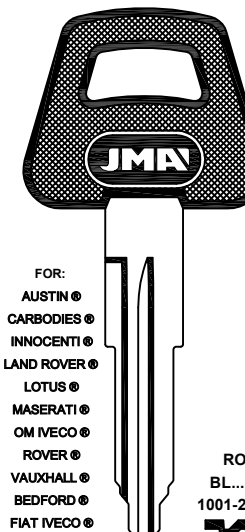

FOR:  
AUSTIN®  
CARBODIES®  
INNOCENTI®  
LAND ROVER  
LOTUS®  
MASERATI®  
OM IVECO®  
ROVER®  
VAUXHALL®  
BEDFORD®  
FIAT IVECO®

FOR: L. & F.®

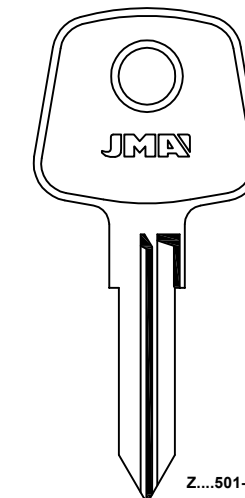

RO  
BL...N  
1001-2000  
LF-RO

FOR: L. & F.®

Z...501-3278  
P...501-3278  
SIP-1

FOR: SIPEA®

FOR: OM IVECO®

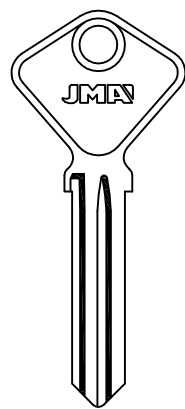

S  
615-699  
712-799  
812-899  
AF-4I

FOR: SAFE®  
FOR: FIST® -TRAMA®

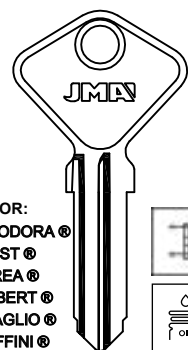

FOR:  
CROMODORA®  
FIST®  
FREA®  
GIOBERT®  
MIRAGLIO®  
RUFFINI®

6  
100-309  
AF-5I

2  
100-309  
AF-6I

FOR: SAFE®

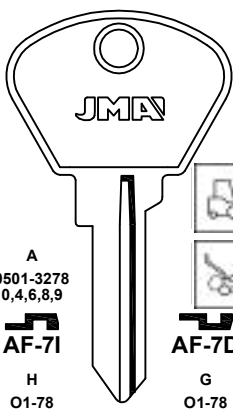

A  
0501-3278  
0,4,6,8,9  
AF-7I

H  
01-78  
AF-8I

F  
01-78  
AF-9I

FOR: SIPEA®

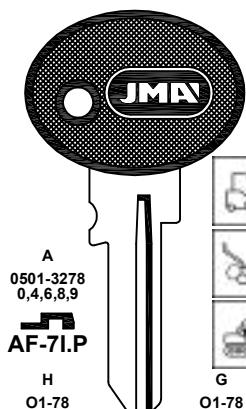

A  
0501-3278  
0,4,6,8,9  
AF-7I.P

H  
01-78  
AF-8I.P

F  
01-78  
AF-9I.P

FOR: SIPEA®

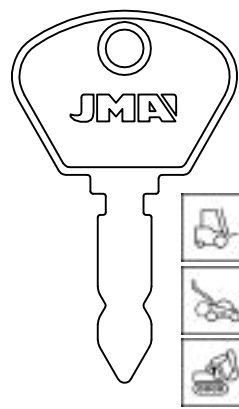

7,1  
1,95  
BH-4

FOR: BOSCH®  
FOR: KOLB® -POLAR®

FOR: OM IVECO®

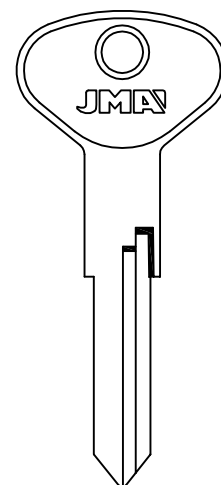

AH...  
1-8154  
1001-9282  
VO-AH

HV...  
1-8154  
1001-9282  
VO-HV

VB-NV-MD...  
1-8154  
1001-9282  
VO-VB

N...  
VO-N

FOR: HUF®  
FOR: AKS® -CASI® -UBE® -WITTE®

AN...  
001-854  
1001-1918  
2001-2830  
3001-3890  
4001-5151  
6001-7086  
7001-8154  
8201-9282  
AU-AN

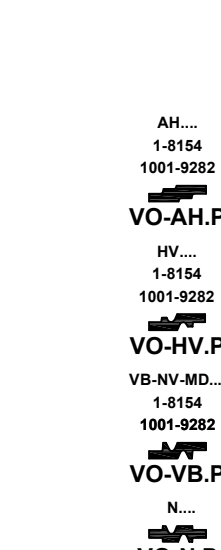

AH...  
1-8154  
1001-9282  
VO-AH.P

HV...  
1-8154  
1001-9282  
VO-HV.P

VB-NV-MD...  
1-8154  
1001-9282  
VO-VB.P

N...  
VO-N.P

FOR: HUF®  
FOR: AKS® -CASI® -UBE® -WITTE®

AN...  
001-854  
1001-1918  
2001-2830  
3001-3890  
4001-5151  
6001-7086  
7001-8154  
8201-9282  
AU-AN.P

FOR: OPEL-VAUXHALL®

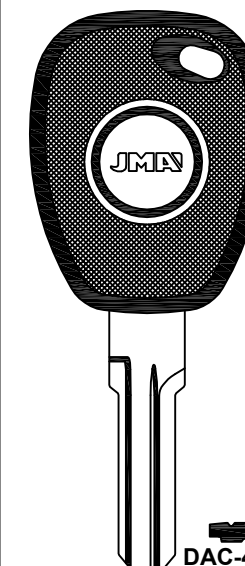

DAC-4D.P  
FOR: DACIA®

FOR: OM IVECO®

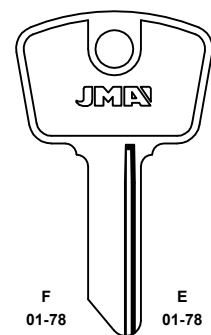

F  
01-78  
FEM-1I

H  
01-78  
FEM-2I

FEM-3I

FOR: FEMSA®

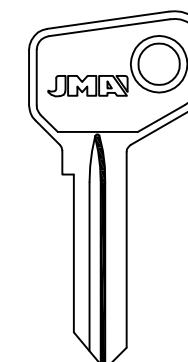

FI-5I

FOR: GIOBERT®  
FOR: IACAM®

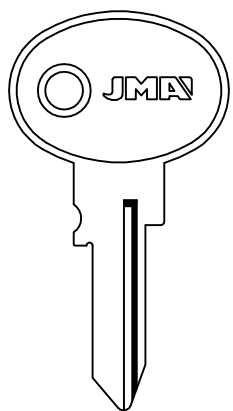

M  
0001-1050  
FI-9I

FOR: GIOBERT®

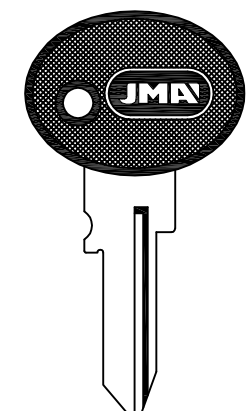

M  
0001-1050  
FI-9I.P

FOR: GIOBERT®

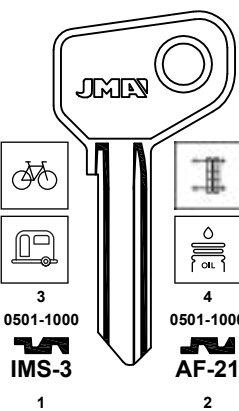

3  
0501-1000  
IMS-3

1  
0501-1000  
IMS-5

IMS-13

FOR: SAFE®  
FOR: CROMODORA® -FIST® -IMSA®

FOR: OPEL-VAUXHALL®

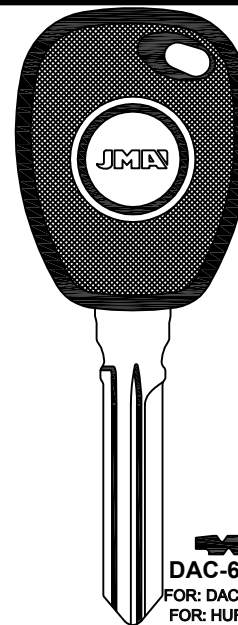

DAC-6D.P  
FOR: DACIA®  
FOR: HUF®

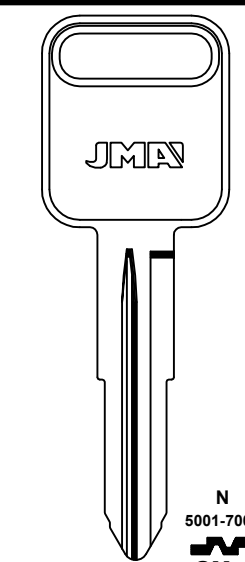

N  
5001-7000  
GM-4  
FOR: G.M.®

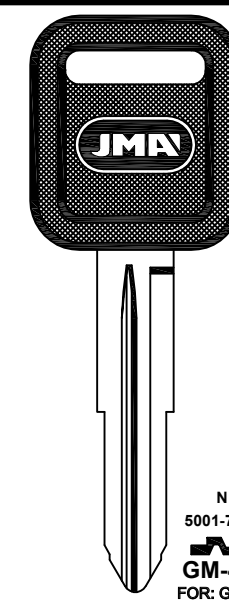

N  
5001-7000  
GM-4.P  
FOR: G.M.®

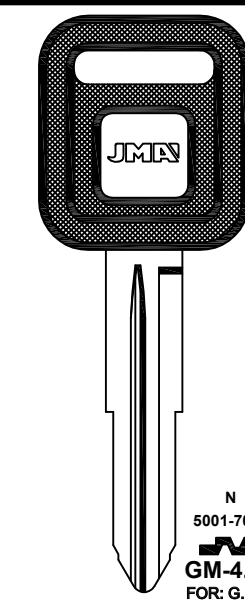

N  
5001-7000  
GM-4.P1  
FOR: G.M.®

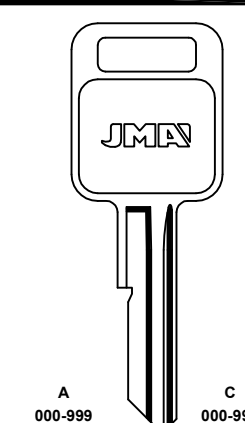

A  
000-999  
GM-6

E  
000-999  
GM-8

FOR: G.M.®

C  
000-999  
GM-7

J  
000-999  
GM-9

FOR: G.M.®

Concerning the marks and commercial denominations see legal warning.  
Concerniente a las marcas y denominaciones comerciales ver aviso legal.  
Marka eta izendapen komertzialiei dagokienez, ikus lege-oharra.  
Concernant les marques et denominations commerciales voir la note dans l'index.

**JMA** Opening the future

**JMA** Opening the future

Beziehen auf die Marke und Handelsname sehen Sie die Notiz im Impressum.  
Relativamente às marcas e denominações comerciais, ver aviso legal.  
Jeśli chodzi o znaki i nazwy handlowe, patrz Informacje prawne.



FOR: OPEL-VAUXHALL ®

SR  
001-240  
KSR  
001-240  
LSR  
001-240  
TSR  
001-240  
HU-SR

SU  
001-240  
401-630  
HU-SU  
SX  
001-240  
HU-SX  
SY  
001-240  
HU-SY

A 000-999 GM-6.P  
C 000-999 GM-7.P  
A 000-999 GM-A  
C 000-999 GM-C  
A 000-999 GM-A.P  
C 000-999 GM-C.P  
E 000-999 GM-8.P  
J 000-999 GM-9.P  
E 000-999 GM-E  
J 000-999 GM-J  
E 000-999 GM-E.P  
J 000-999 GM-J.P  
SE 001-750  
SC 401-630  
HU-SC  
SZ 1-240  
HU-SZ

FOR: G.M. ®  
FOR: BRIGGS STRATTON ®

FOR: G.M. ®  
FOR: BRIGGS STRATTON ®

FOR: G.M. ®  
FOR: BRIGGS STRATTON ®

FOR: HUF ®  
FOR: AKS ®

FOR: OPEL-VAUXHALL ®

H 7001-8400 MIT-3  
FOR: MITSUBISHI ®

H 7001-8400 MIT-3.P  
FOR: MITSUBISHI ®

6 001-250 OP-6  
7 001-250 OP-7  
8 001-250 OP-8  
9 001-250 OP-9

AB... 1-1000 OP-AB  
BA... 1-1000 OP-BA  
AB... 1-1000 OP-AB.P  
BA... 1-1000 OP-BA.P

FOR: HUF ®  
FOR: YMOS ®

FOR: HUF ®  
FOR: YMOS ®

FOR: HUF ®  
FOR: YMOS ®

FOR: HUF ®  
FOR: YMOS ®

FOR: OPEL-VAUXHALL ®

CC...501-1000  
CC...1751-2000  
CC...2501-3000  
OP-CC

DD...501-1000  
DD...1751-2000  
DD...2501-3000  
OP-DD

B...1-380  
BB...501-1000  
BB...1751-2000  
BB...2501-3000  
OP-BB

EE...501-1000  
EE...1751-2000  
EE...2501-3000  
OP-EE

FF...501-1000  
FF...1751-2000  
FF...2501-3000  
OP-FF

D 1-5200 OP-D  
S... 1-5200 OP-S  
D 1-5200 OP-D.P  
S... 1-5200 OP-S.P  
A... 1-500 OP-NA  
B... 1-500 OP-NB

FOR: HUF ®  
FOR: YMOS ®

FOR: HUF ®  
FOR: YMOS ®

FOR: HUF ®  
FOR: YMOS ®

FOR: OPEL-VAUXHALL ®

G...1-250  
G...1251-1500  
OP-HG

H...1-250  
H...1251-1500  
OP-HH

J... 1-2874  
OP-J

J... 1-2874  
OP-J.P

R... 1-1500  
OP-R

R... 1-1500  
OP-R.P

FOR: HUF ®

FOR: HUF ®

FOR: HUF ®

FOR: HUF ®

FOR: HUF ®

FOR: YMOS ®

FOR: YMOS ®

FOR: OPEL-VAUXHALL ®

S... 1-5200  
OP-S.P1  
FOR: HUF ®

T... 1-500  
501-1500  
OP-T

T... 1-500  
501-1500  
OP-T.P

H... WH... 0001-3000  
LAT. 2.95  
FOR: ASTON MARTIN ®  
GM ®  
HOLDEN ®  
IRMSCHER ®  
OPEL ®  
VAUXHALL ®

7.18  
2.95  
OP-WH.P

WY... 0001-3000  
Y...  
6.88  
2.95  
OP-WY.P

FOR: HUF ®

FOR: YMOS ®

FOR: HUF ®

FOR: YMOS ®

FOR: HUF ®

FOR: YMOS ®

FOR: PEUGEOT ®

FOR: A.MOTORS  
CITROEN ®  
MAZDA ®  
PEUGEOT ®  
RENAULT ®  
TALBOT  
DAF ®  
NISSAN ®  
PEGASO ®

.....  
A-Z  
B-C-D-E  
1/9...A-Z  
1/9...A-Z  
1/9...A-Z  
1/9...A-Z  
1/9...A-Z  
E-M-N-P-R  
CHR-3  
FOR: CHRYSLER ®  
FOR: CLAUSOR ®-NEIMAN ®

FOR: PEUGEOT ®

.....  
A-Z  
B-C-D-E  
1/9...A-Z  
1/9...A-Z  
1/9...A-Z  
1/9...A-Z  
B-D-E-G-H-J  
.1/9...A-Z  
.1/9...A-Z  
E-M-N-P-R  
CHR-3.P  
FOR: CHRYSLER ®  
FOR: CLAUSOR ®-NEIMAN ®

FOR: A.MOTORS  
CITROEN ®  
MAZDA ®  
PEUGEOT ®  
RENAULT ®  
TALBOT  
DAF ®  
NISSAN ®  
PEGASO ®

CHR-4I

CHR-4D

RO-1IS

RO-1DS

C 001-224  
RO-3

6 100-517  
FAR-1I

8 100-517  
FAR-1D

2 100-517  
FAR-2I

4 100-517  
FAR-2D

H 100-309  
FAR-3

FAR-3D

FAR-4D

FI-3

FI-3D

G 7001-9956  
Z-GR 7001-9956  
FI-2D  
G 2001-4530  
G-Z 7001-9956  
FI-3D  
G 7001-9956  
FI-12

FOR: FARMA ®  
FOR: FISAM ®

FOR: GIOBERT ®

Concerning the marks and commercial denominations see legal warning.  
Concerniente a las marcas y denominaciones comerciales ver aviso legal.  
Marka eta izendapen komertzialiei dagokienez, ikus lege-oharra.  
Concernant les marques et denominations commerciales voir la note dans l'index.

**JMA** Opening the future

**JMA** Opening the future

Beziehen auf die Marke und Handelsname sehen Sie die Notiz im Impressum.  
Relativamente às marcas e denominações comerciais, ver aviso legal.  
Jeśli chodzi o znaki i nazwy handlowe, patrz Informacje prawne.

FOR: PEUGEOT®

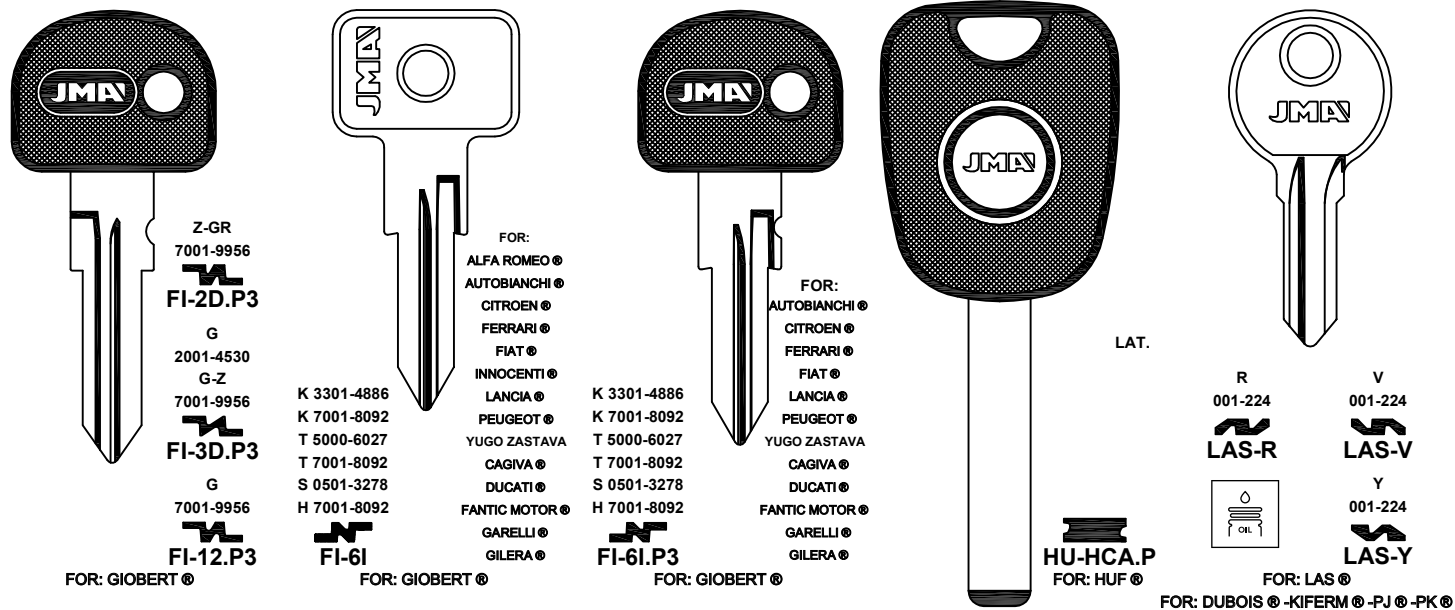

FOR: PEUGEOT®

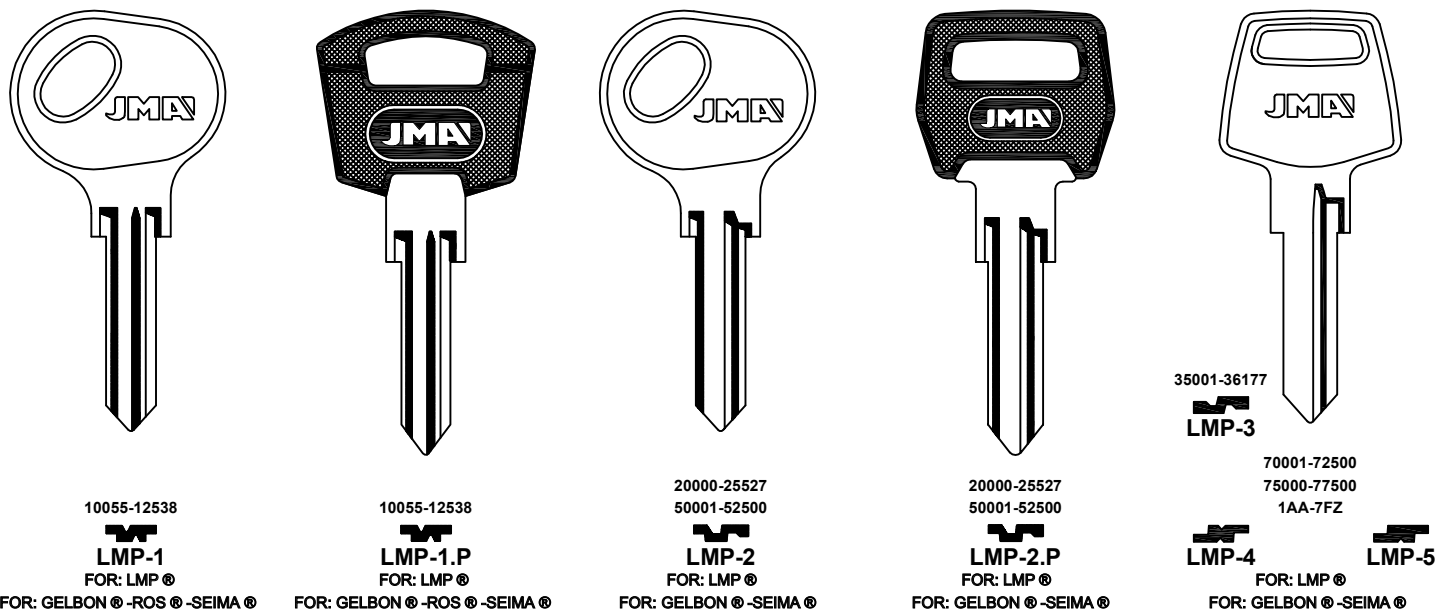

FOR: PEUGEOT®

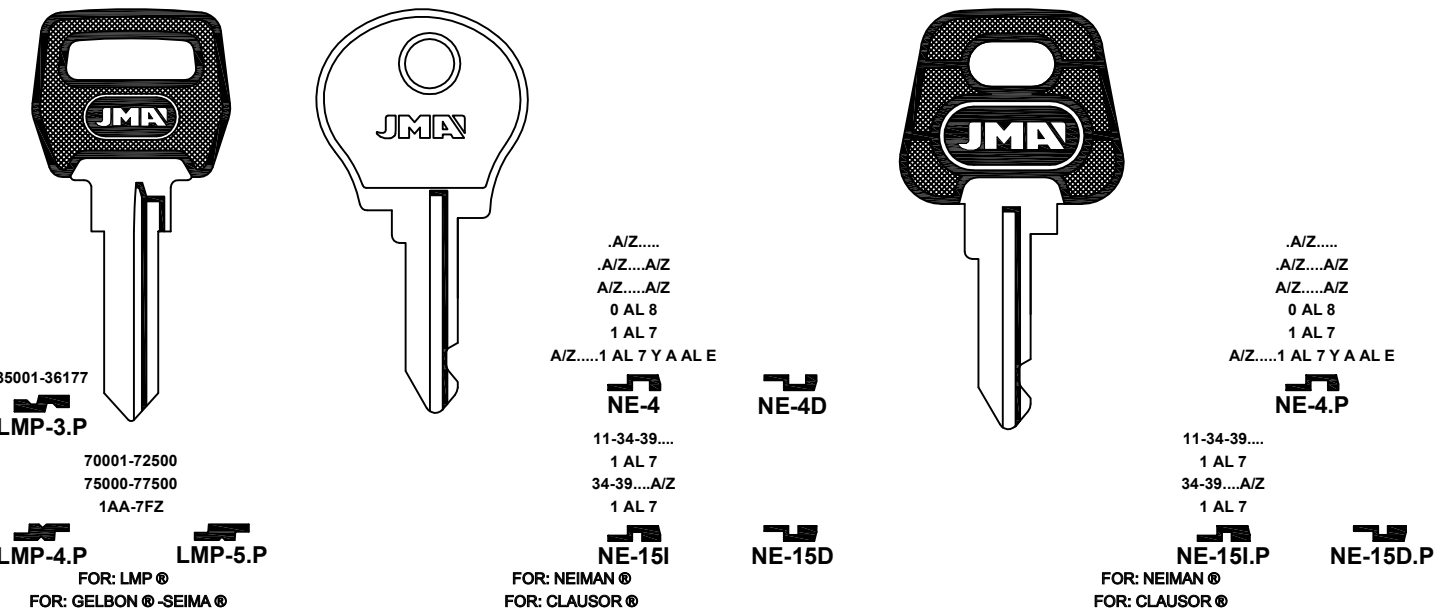

FOR: PEUGEOT®

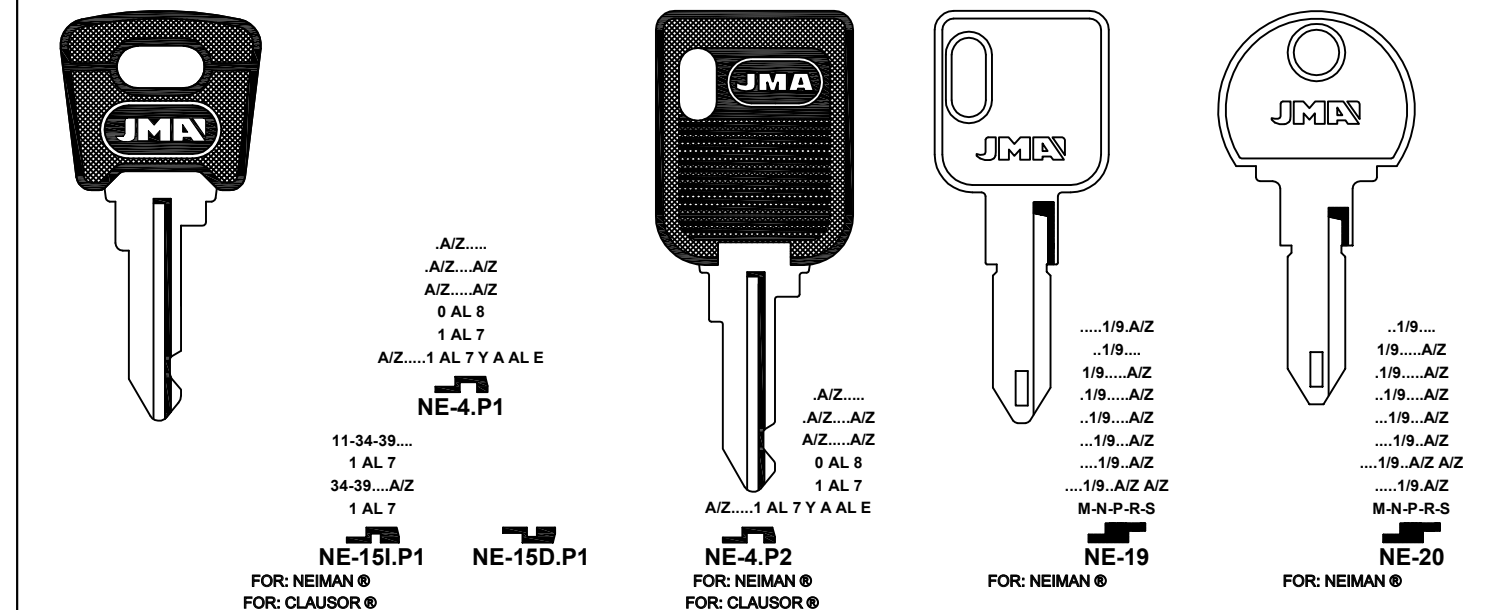

FOR: PEUGEOT®

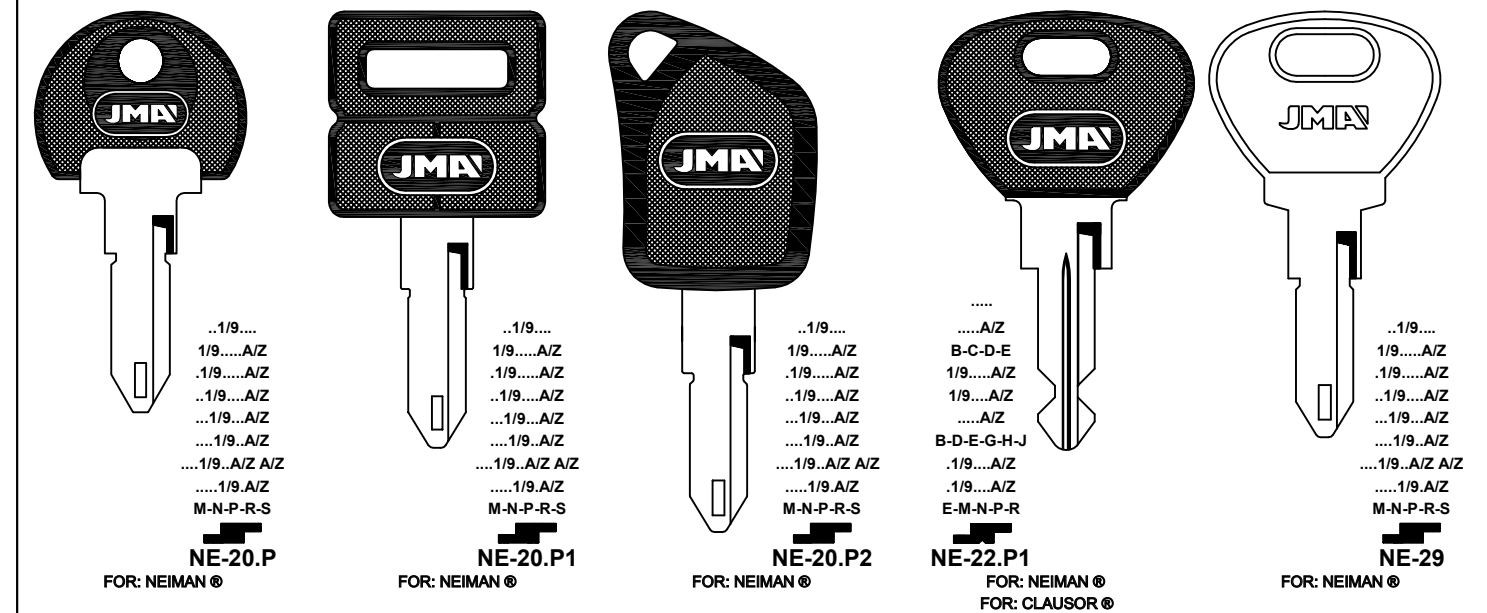

FOR: PEUGEOT®

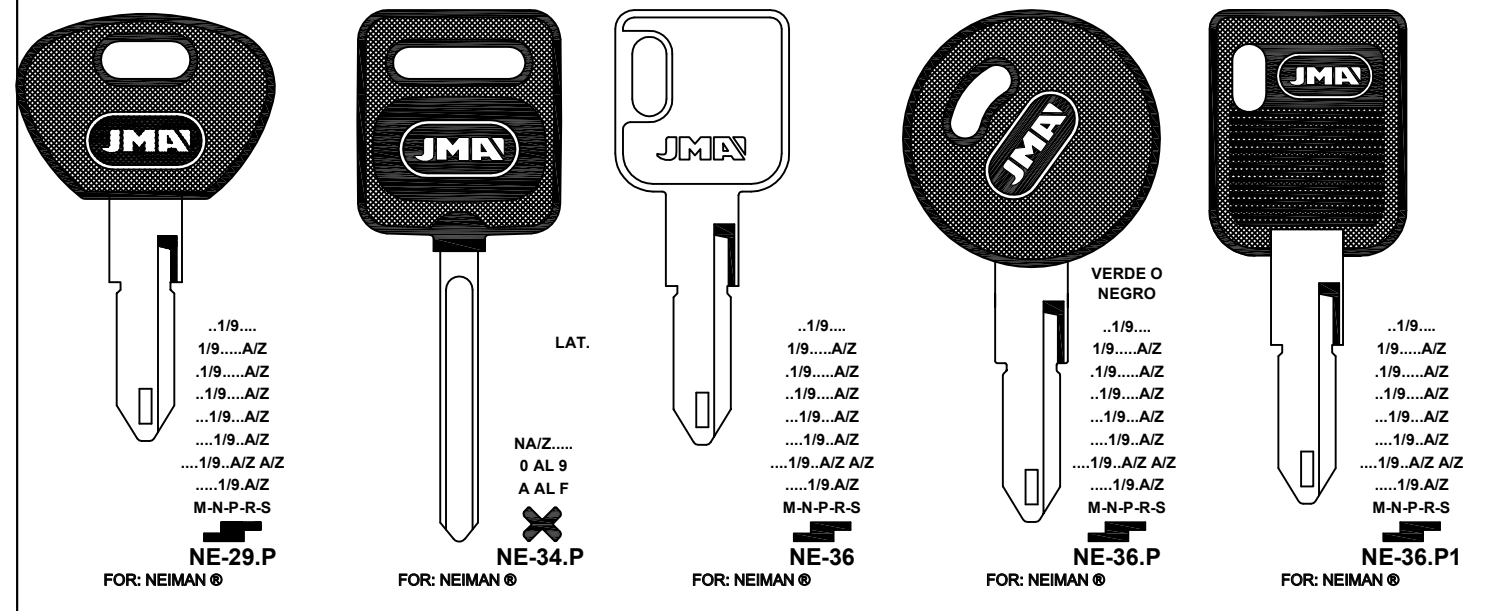

Concerning the marks and commercial denominations see legal warning.  
Concerniente a las marcas y denominaciones comerciales ver aviso legal.  
Marka eta izendapen komertzialiei dagokienez, ikus lege-oharra.  
Concernant les marques et dénominations commerciales voir la note dans l'index.





FOR: PEUGEOT (ARGENTINA) ®

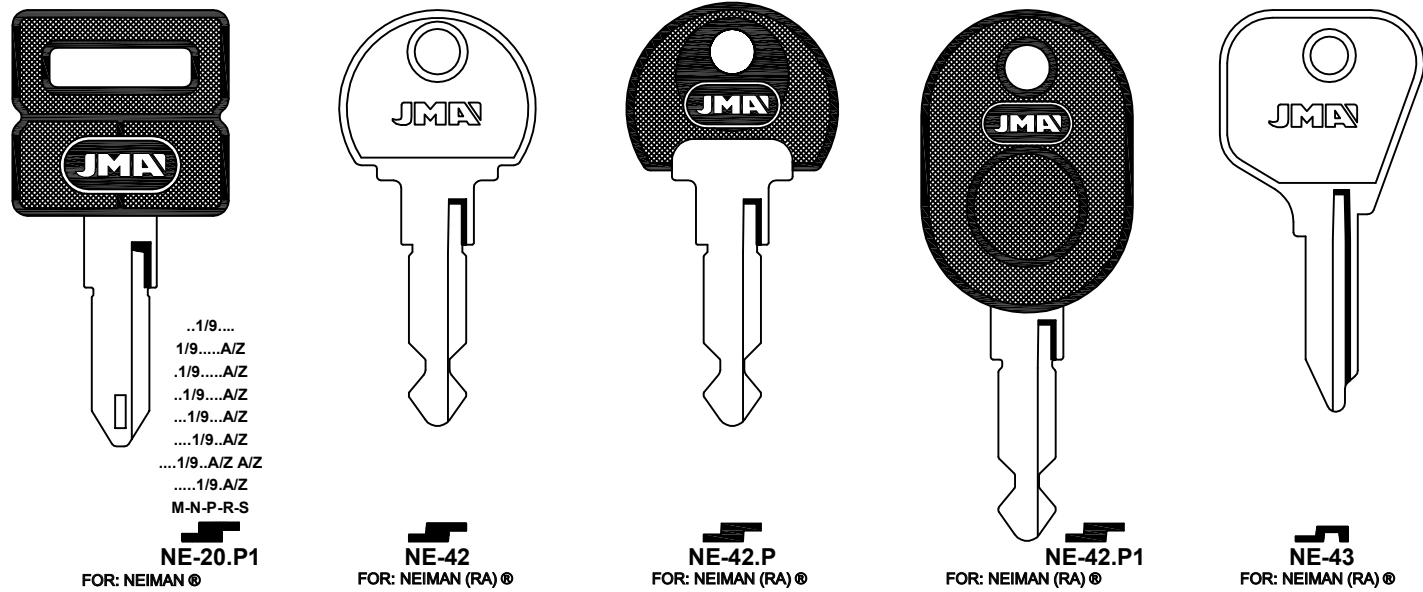

FOR: PLYMOUTH ®

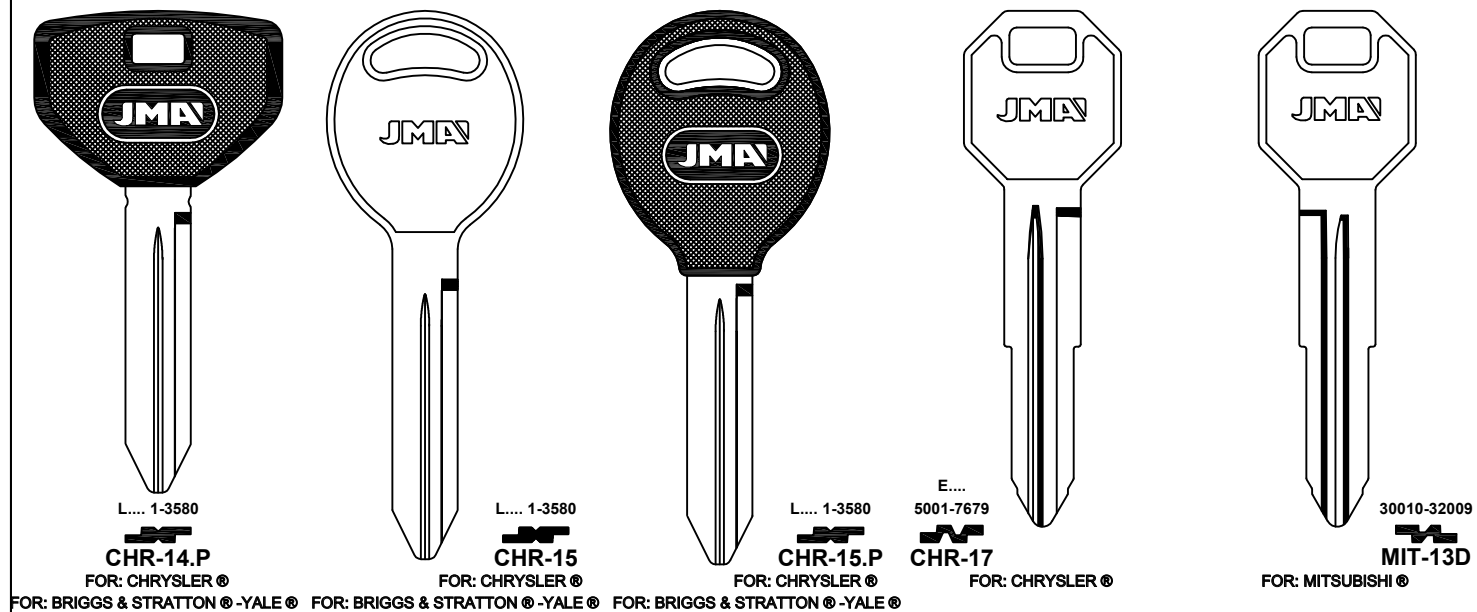

FOR: PEUGEOT (ARG.) ®

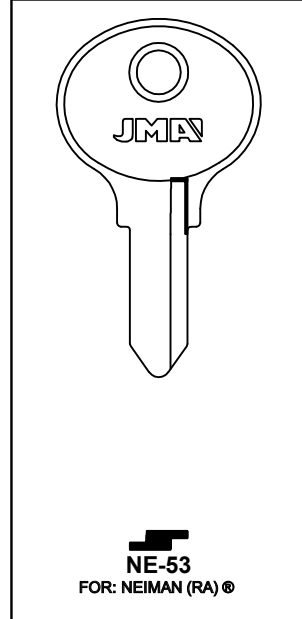

FOR: PIAGGIO ®

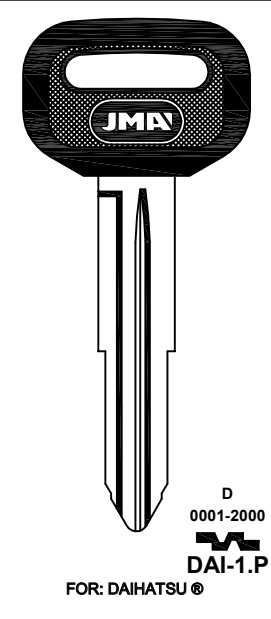

FOR: PLYMOUTH ®

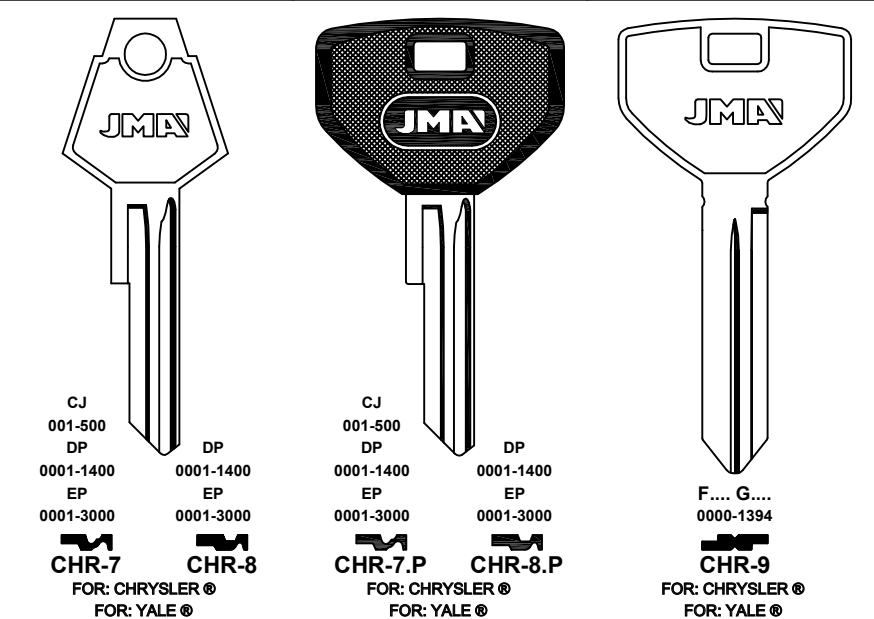

FOR: PLYMOUTH ®

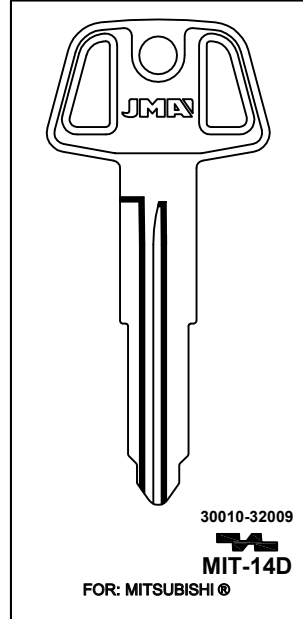

FOR: PORSCHE ®

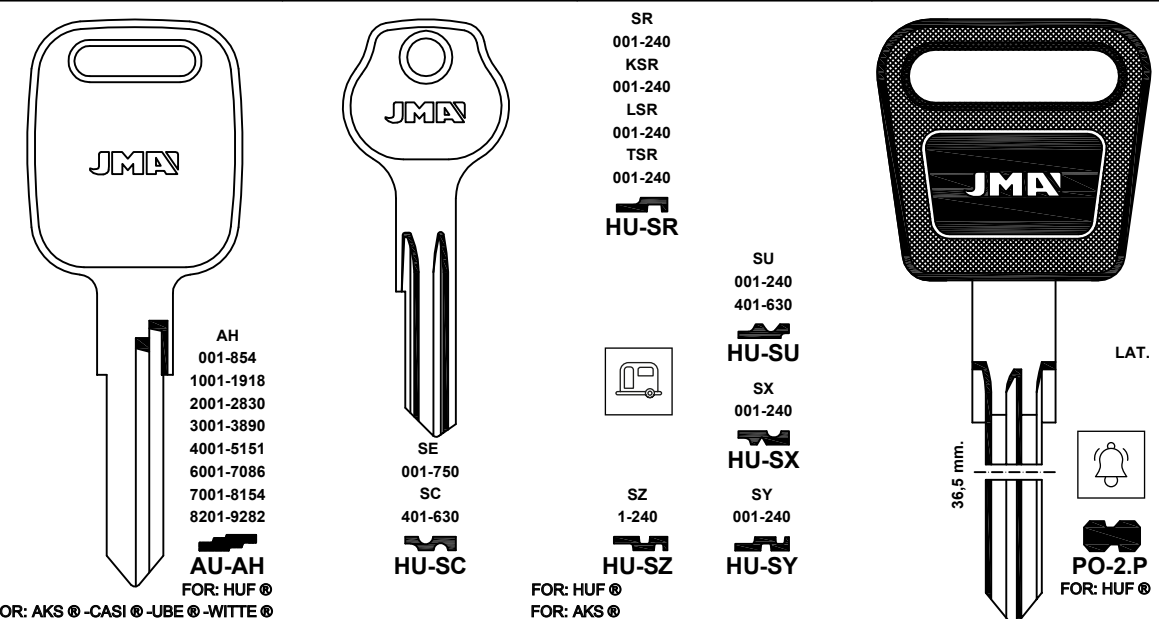

FOR: PLYMOUTH ®

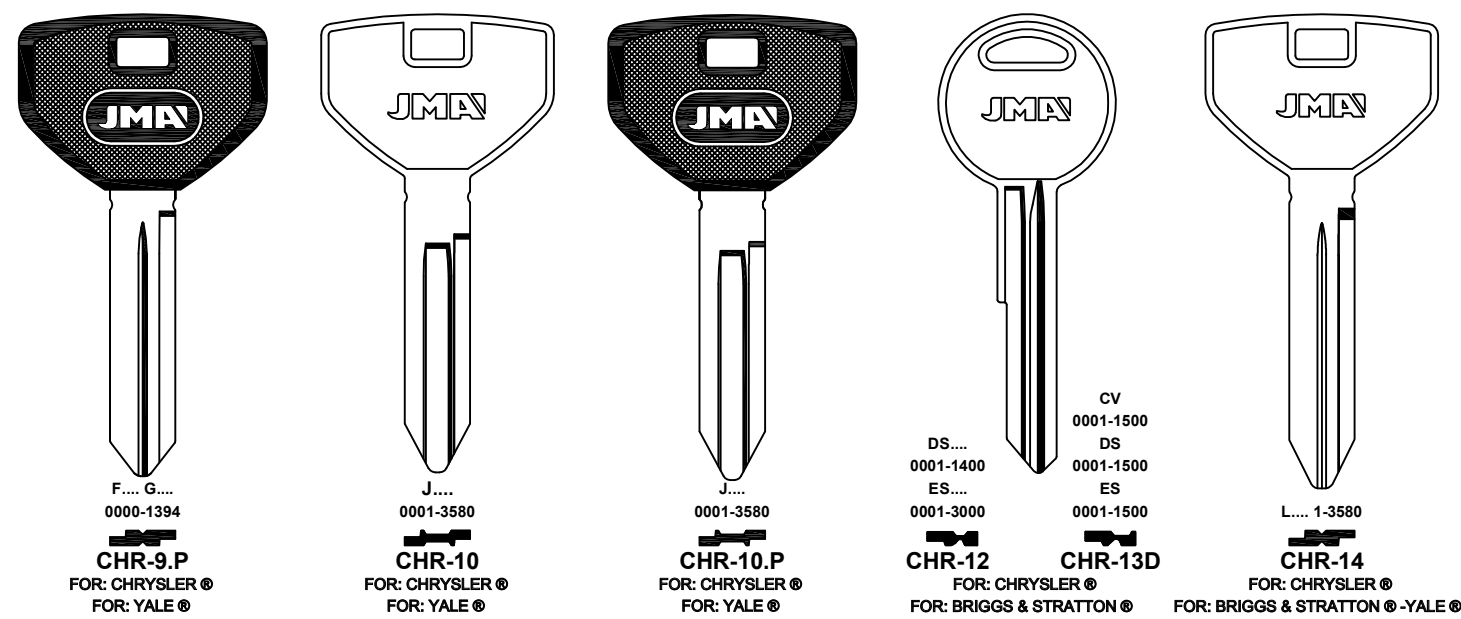

FOR: PORSCHE ®

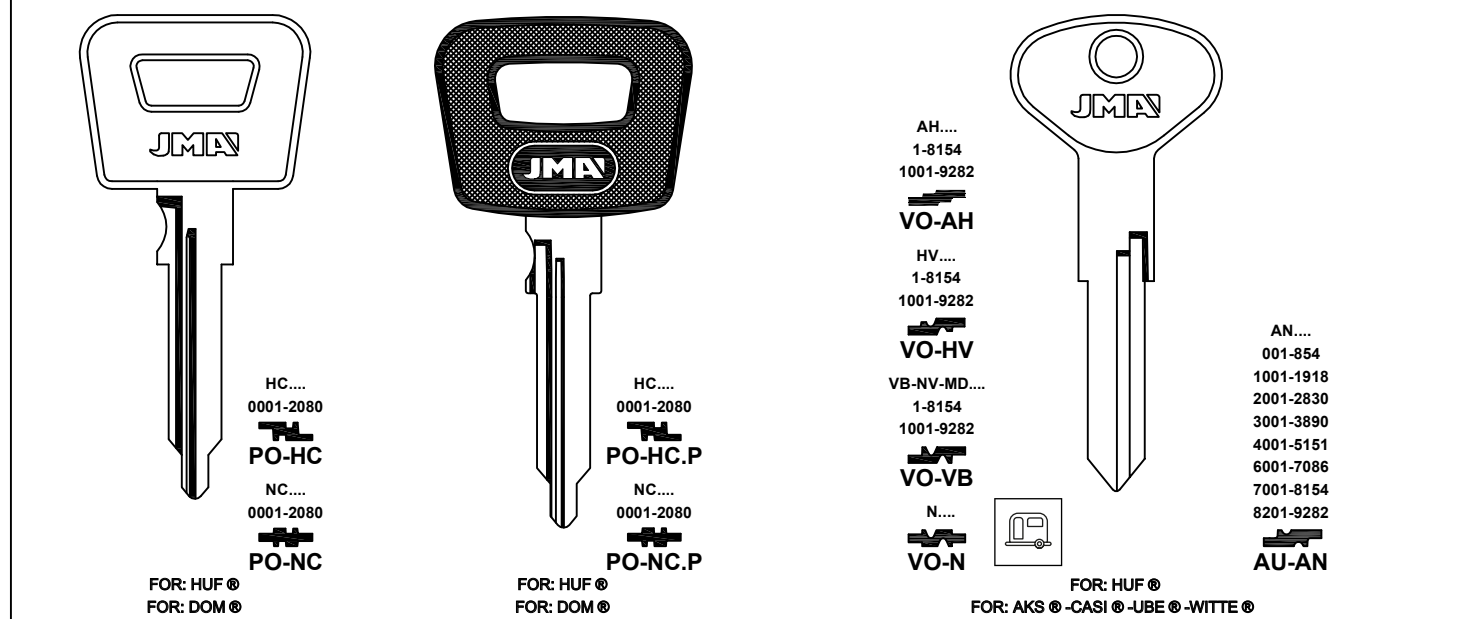

Concerning the marks and commercial denominations see legal warning.  
Concerniente a las marcas y denominaciones comerciales ver aviso legal.  
Marka eta izendapen komertzialiei dagokienez, ikus lege-oharra.  
Concernant les marques et denominations commerciales voir la note dans l'index.

**JMA** Opening the future

**JMA** Opening the future

Beziehen auf die marke und handelsname sehen sie die notiz im Impressum.  
Relativamente às marcas e denominações comerciais, ver aviso legal.  
Jeśli chodzi o znaki i nazwy handlowe, patrz Informacje prawne.



**FOR: PORSCHE®**

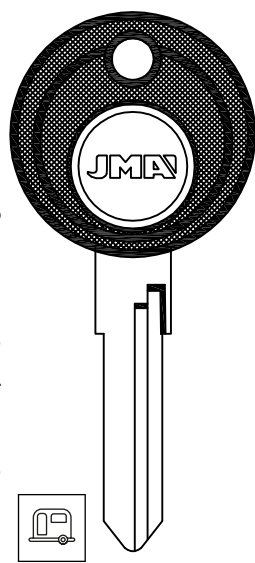

AH....  
1-8154  
1001-9282  
**VO-AH.P**

HV....  
1-8154  
1001-9282  
**VO-HV.P**

VB-NV-MD....  
1-8154  
1001-9282  
**VO-VB.P**

N....  
**VO-N.P**

AN....  
001-854  
1001-1918  
2001-2830  
3001-3890  
4001-5151  
6001-7086  
7001-8154  
8201-9282  
**AU-AN.P**

FOR: HUF®  
FOR: AKS® -CASI® -UBE® -WITTE®

**FOR: PREMIER®**

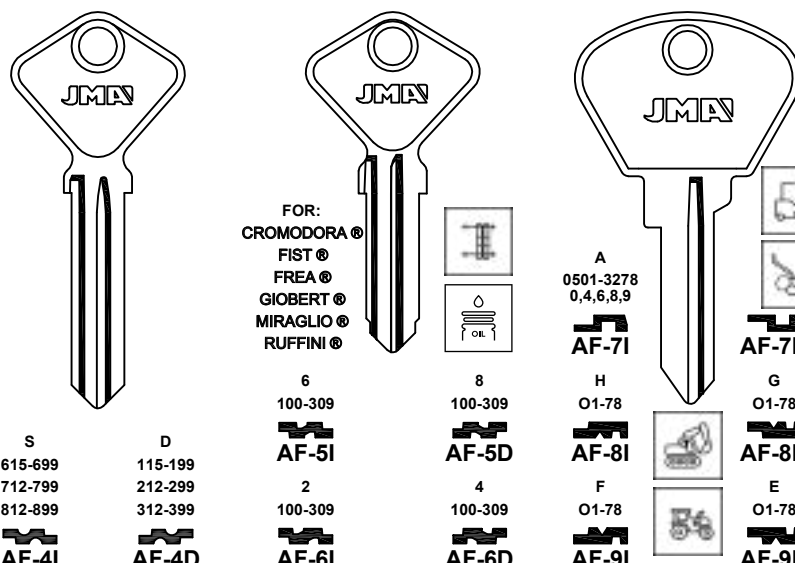

FOR: CROMODORA®  
FIST®  
FREA®  
GIOBERT®  
MIRAGLIO®  
RUFFINI®

A  
0501-3278  
0,4,6,8,9  
**AF-7I**

H  
O1-78  
**AF-8I**

F  
O1-78  
**AF-9I**

G  
O1-78  
**AF-7D**

O  
O1-78  
**AF-8D**

E  
O1-78  
**AF-9D**

S  
615-699  
712-799  
812-899  
**AF-4I**

D  
115-199  
212-299  
312-399  
**AF-4D**

6  
100-309  
**AF-5I**

8  
100-309  
**AF-5D**

2  
100-309  
**AF-6I**

4  
100-309  
**AF-6D**

FOR: SAFE®  
FOR: FIAT® -TRAMA®

FOR: SAFE®  
FOR: SAFE®

FOR: SIPEA®  
FOR: SAFE®

**FOR: RAYTON FISSORE®**

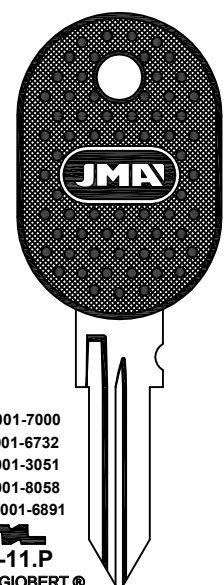

N 6001-7000  
J 3001-6732  
V 0001-3051  
V 5001-8058  
AB 6001-6891  
**FI-11.P**  
FOR: GIOBERT®

**FOR: RENAULT®**

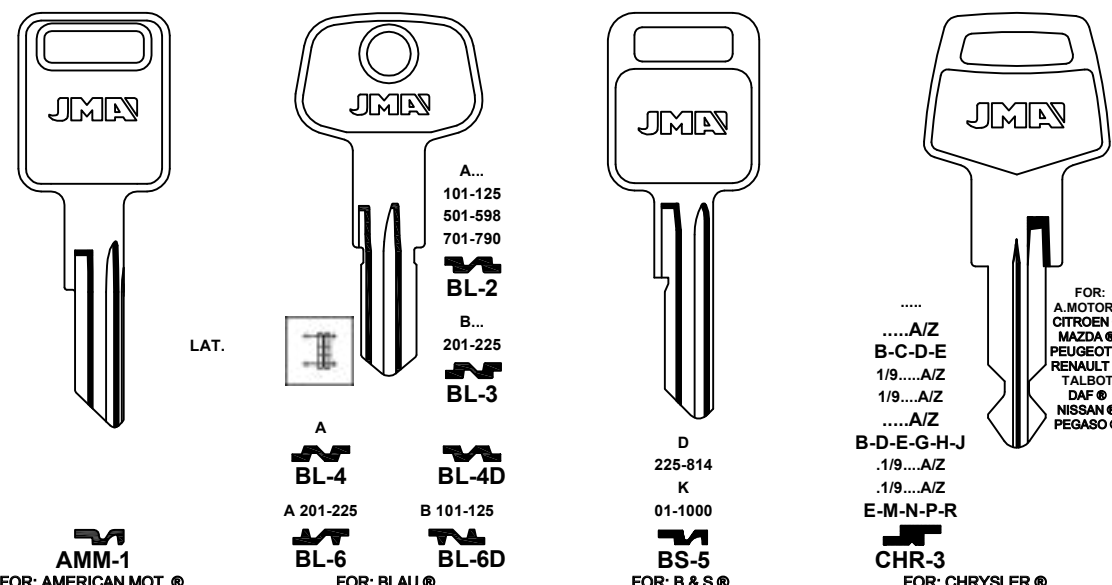

LAT.

A...  
101-125  
501-598  
701-790  
**BL-2**

B...  
201-225  
**BL-3**

A  
**BL-4**

A 201-225  
**BL-6**

B 101-125  
**BL-6D**

D  
225-814  
K  
01-1000  
**BS-5**  
FOR: B & S®

FOR: AMERICAN MOT.®

FOR: BLAU®

FOR: FORT® -HK® -WASO®

FOR: POLLAK® -BOBCAT®

FOR: CLAUSOR® -NEIMAN®

FOR: A MOTORS  
CITROEN®  
MAZDA®  
PEUGEOT®  
RENAULT®  
TALBOT®  
DAF®  
NISSAN®  
PEGASO®

.....  
A/Z  
B-C-D-E  
1/9...A/Z  
1/9...A/Z  
.....A/Z  
B-D-E-G-H-J  
1/9...A/Z  
1/9...A/Z  
E-M-N-P-R  
**CHR-3**  
FOR: CHRYSLER®

**FOR: PREMIER®**

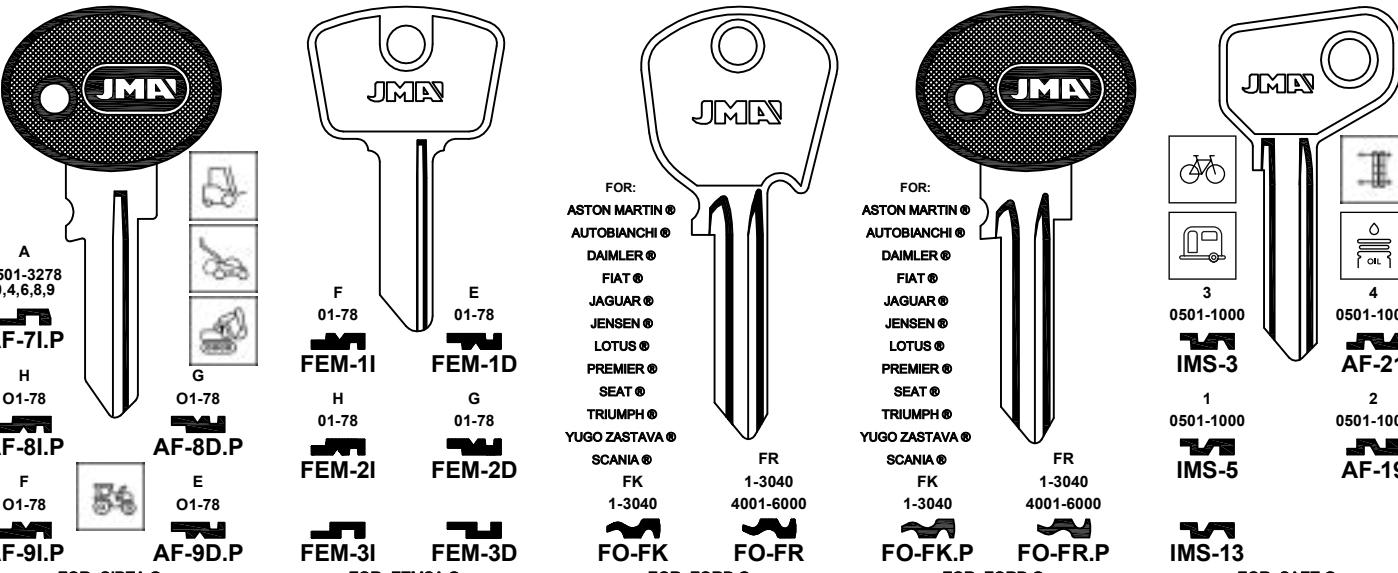

A  
0501-3278  
0,4,6,8,9  
**AF-7I.P**

H  
O1-78  
**AF-8I.P**

F  
O1-78  
**AF-8I**

G  
O1-78  
**AF-8D.P**

F  
O1-78  
**AF-9I.P**

E  
O1-78  
**AF-9D.P**

F  
O1-78  
**FEM-1I**

G  
O1-78  
**FEM-1D**

H  
O1-78  
**FEM-2I**

G  
O1-78  
**FEM-2D**

F  
O1-78  
**FEM-3I**

E  
O1-78  
**FEM-3D**

FOR: ASTON MARTIN®  
AUTOBIANCHI®  
DAIMLER®  
FIAT®  
JAGUAR®  
JENSEN®  
LOTUS®  
PREMIER®  
SEAT®  
TRIUMPH®  
YUGO ZASTAVA®

FOR: ASTON MARTIN®  
AUTOBIANCHI®  
DAIMLER®  
FIAT®  
JAGUAR®  
JENSEN®  
LOTUS®  
PREMIER®  
SEAT®  
TRIUMPH®  
YUGO ZASTAVA®

3  
0501-1000  
**IMS-3**

4  
0501-1000  
**AF-21**

1  
0501-1000  
**IMS-5**

2  
0501-1000  
**AF-19**

IMS-13

FOR: SIPEA®  
FOR: SAFE®

FOR: FORD®  
FOR: ARMAN® -DOM® -JUGODENT® -WASO®

FOR: FORD®  
FOR: FORD®

FOR: SAFE®  
FOR: CROMODORA® -FIST® -IMS®

**FOR: RENAULT®**

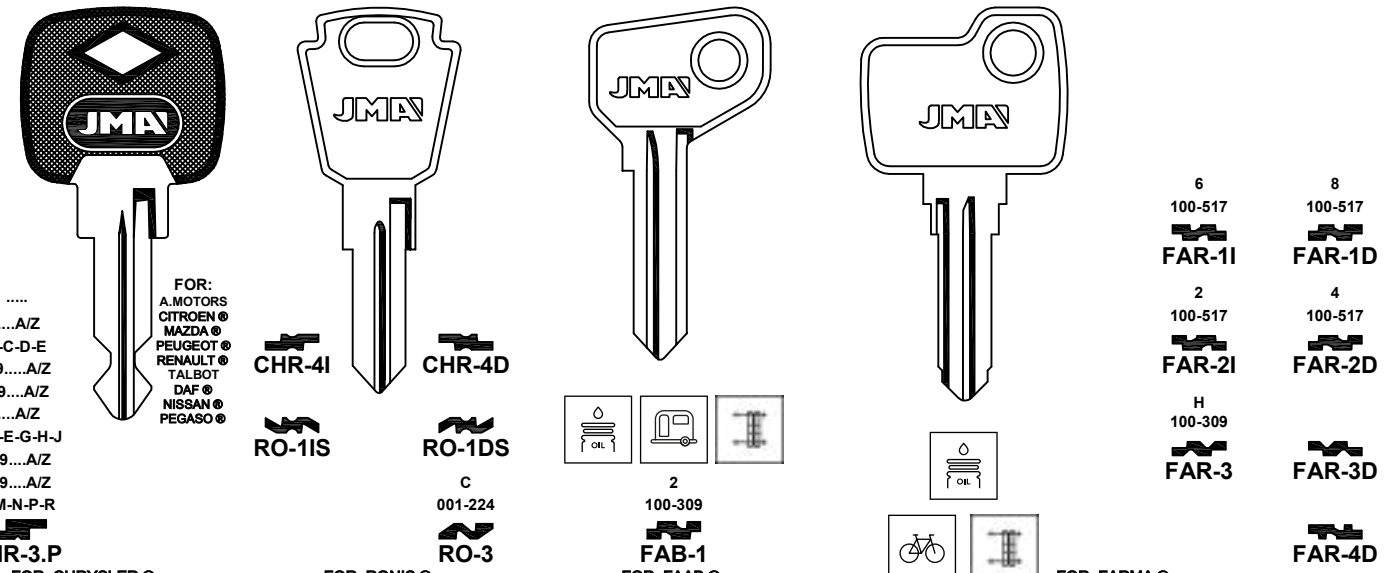

FOR: A MOTORS  
CITROEN®  
MAZDA®  
PEUGEOT®  
RENAULT®  
TALBOT®  
DAF®  
NISSAN®  
PEGASO®

.....  
A/Z  
B-C-D-E  
1/9...A/Z  
1/9...A/Z  
.....A/Z  
B-D-E-G-H-J  
1/9...A/Z  
1/9...A/Z  
E-M-N-P-R  
**CHR-3.P**  
FOR: CHRYSLER®  
FOR: CLAUSOR® -NEIMAN®

FOR: RONIS®

FOR: FAAB®

FOR: FARMA®  
FOR: FISAM®

6  
100-517  
**FAR-1I**

8  
100-517  
**FAR-1D**

2  
100-517  
**FAR-2I**

4  
100-517  
**FAR-2D**

H  
100-309  
**FAR-3**

**FAR-3D**

4  
100-517  
**FAR-4D**

**FOR: PREMIER®**

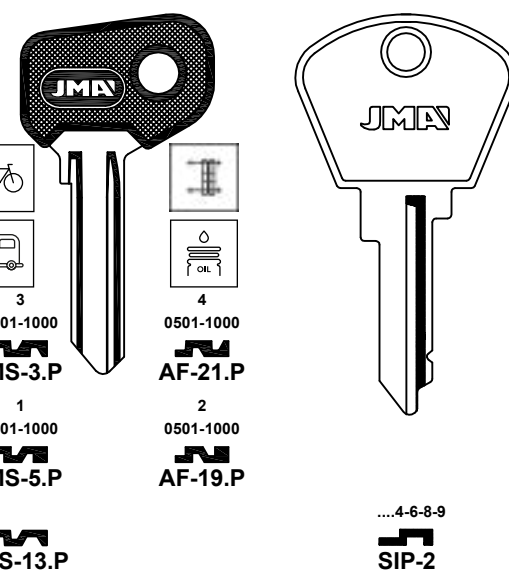

3  
0501-1000  
**IMS-3.P**

4  
0501-1000  
**AF-21.P**

1  
0501-1000  
**IMS-5.P**

2  
0501-1000  
**AF-19.P**

IMS-13.P

FOR: SAFE®  
FOR: CROMODORA® -FIST® -IMS®

FOR: MAGNETI MARELLI® -NEIMAN®

FOR: SIPEA®

**FOR: RAYTON FISSORE®**

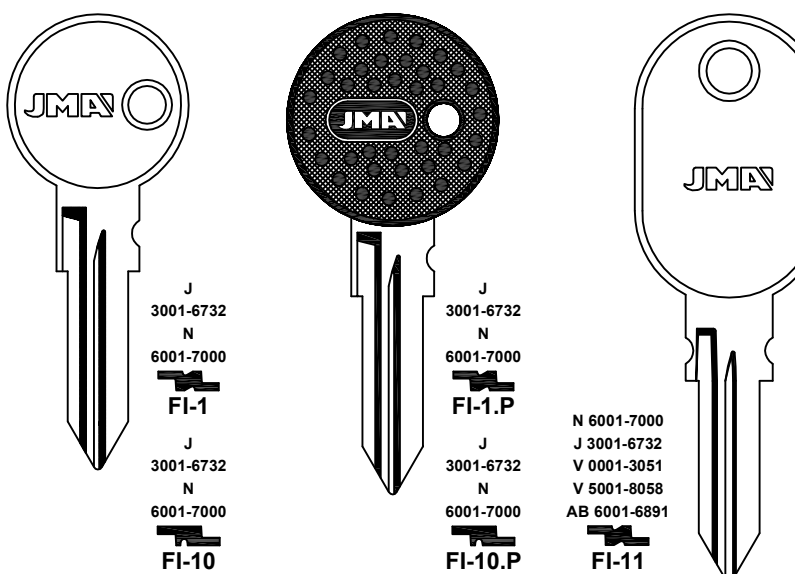

J  
3001-6732  
N  
6001-7000  
**FI-1**

J  
3001-6732  
N  
6001-7000  
**FI-10**

J  
3001-6732  
N  
6001-7000  
**FI-10.P**

N 6001-7000  
J 3001-6732  
V 0001-3051  
V 5001-8058  
AB 6001-6891  
**FI-11**  
FOR: GIOBERT®

FOR: GIOBERT®

FOR: GIOBERT®

**FOR: RENAULT®**

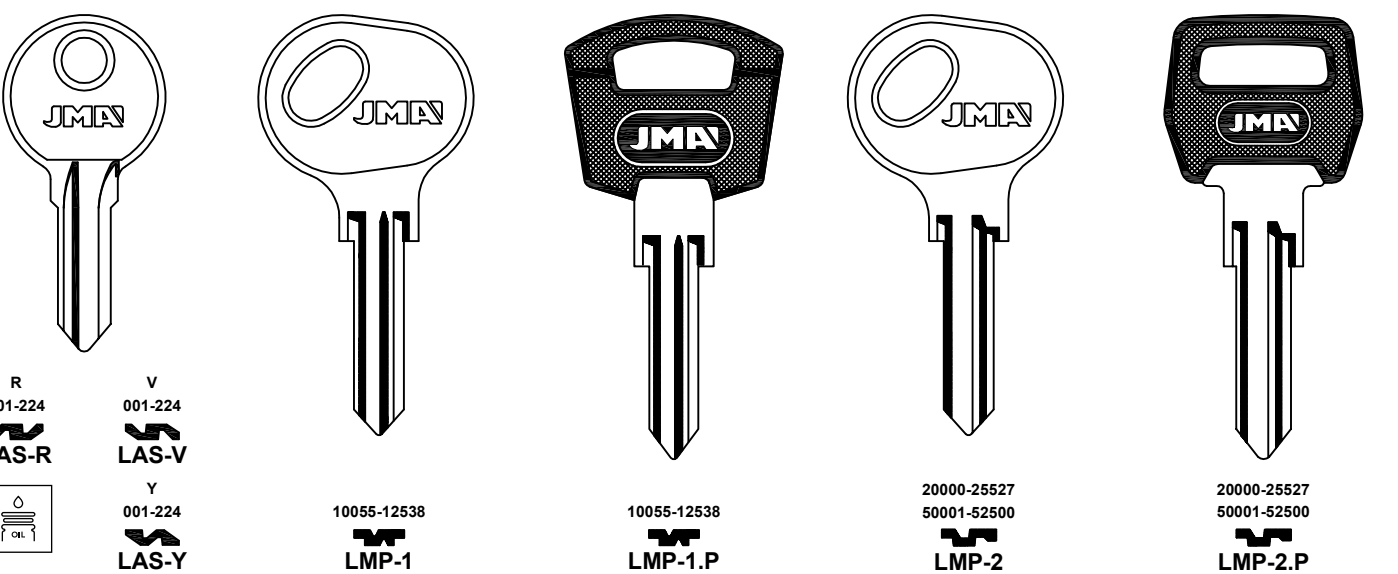

R  
001-224  
**LAS-R**

V  
001-224  
**LAS-V**

Y  
001-224  
**LAS-Y**

FOR: LAS®

10055-12538  
**LMP-1**  
FOR: LMP®

10055-12538  
**LMP-1.P**  
FOR: LMP®

20000-25527  
50001-52500  
**LMP-2**  
FOR: LMP®

20000-25527  
50001-52500  
**LMP-2.P**  
FOR: LMP®

FOR: DUBOIS® -KIFERM® -PJ® -PK®

FOR: GELBON® -ROS® -SEIMA®

FOR: GELBON® -ROS® -SEIMA®

FOR: GELBON® -SEIMA®

FOR: GELBON® -SEIMA®

Concerning the marks and commercial denominations see legal warning.  
Concerniente a las marcas y denominaciones comerciales ver aviso legal.  
Marka eta izendapen komertzialiei dagokienez, ikus lege-oharra.  
Concernant les marques et dénominations commerciales voir la note dans l'index.

FOR: ALFA ROMEO®

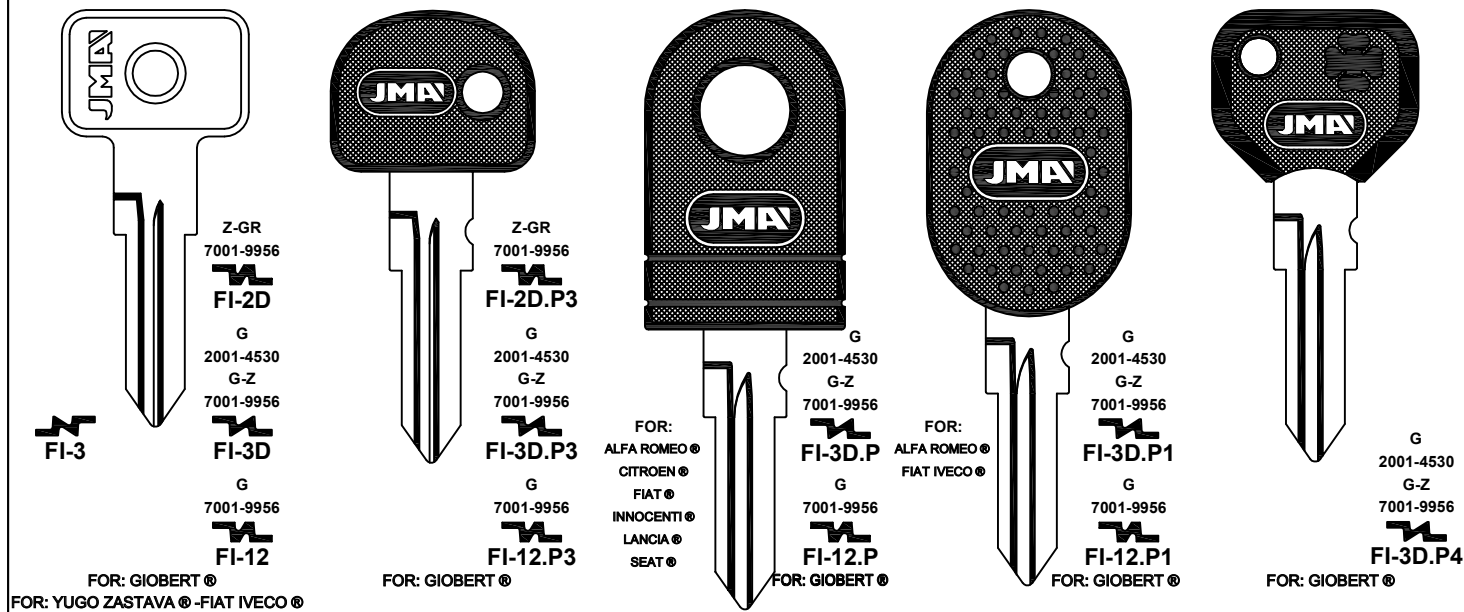

FOR: ALFA ROMEO®

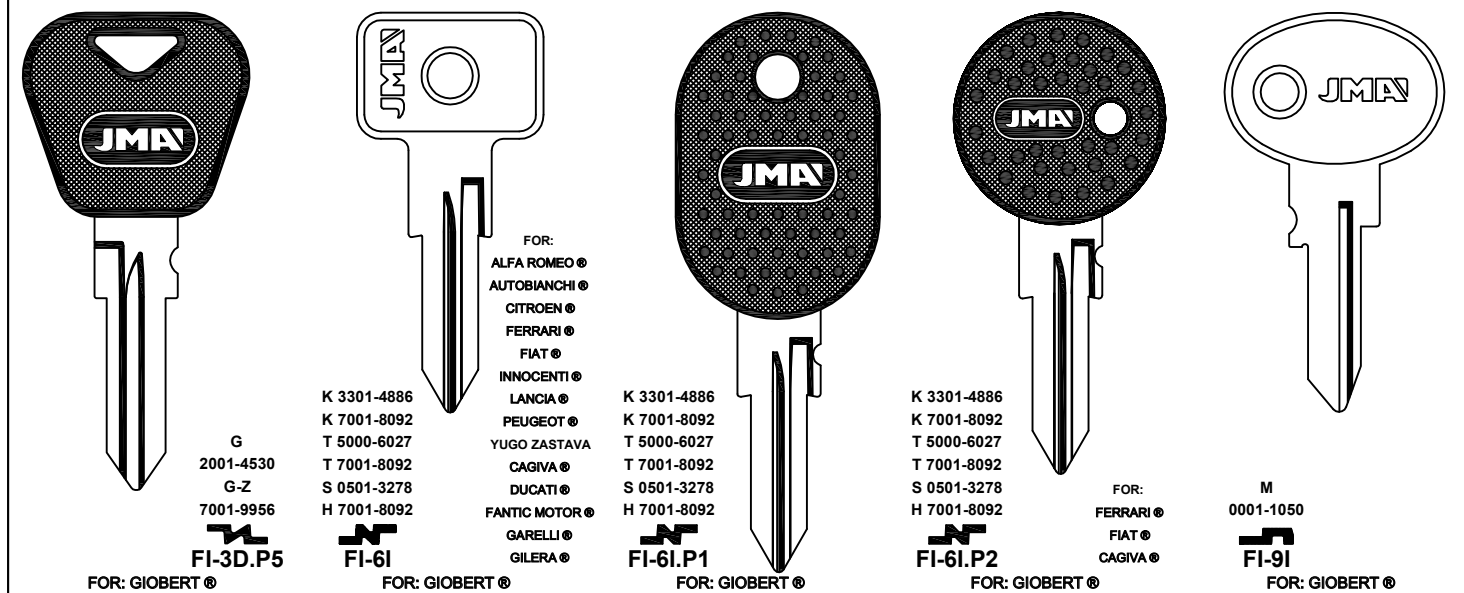

FOR: ALFA ROMEO®

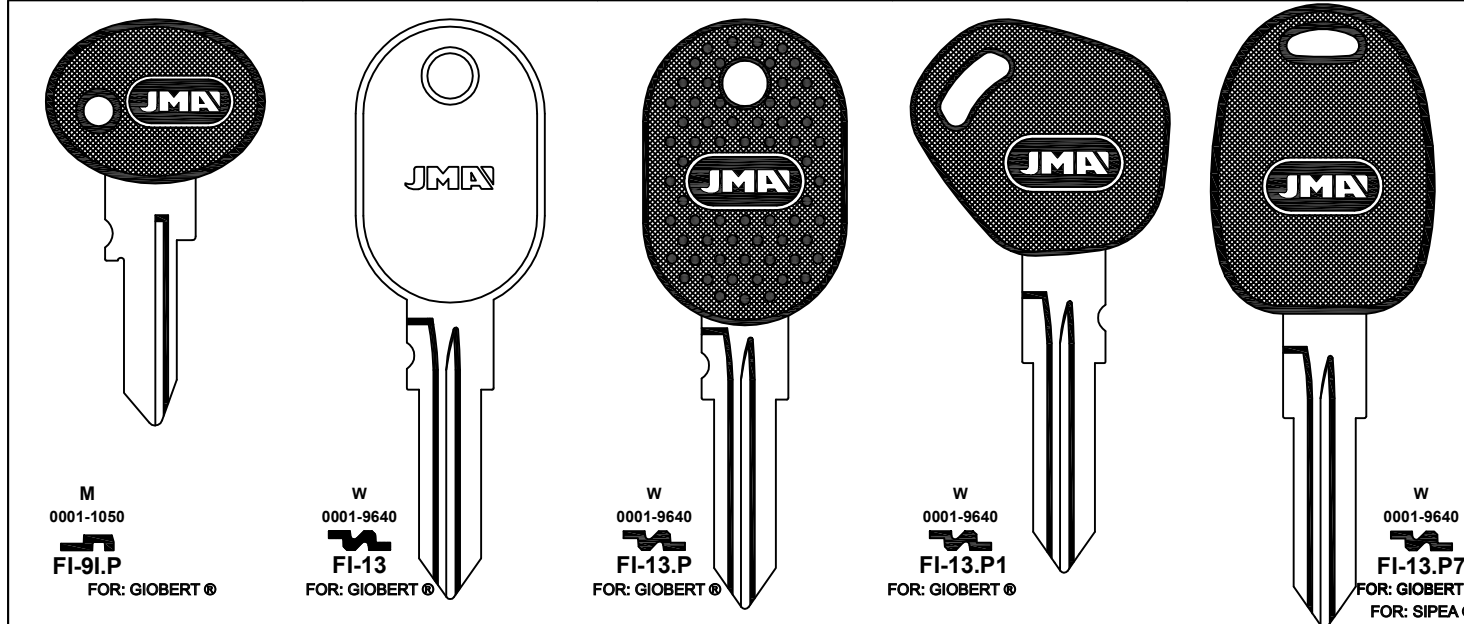

FOR: RENAULT®

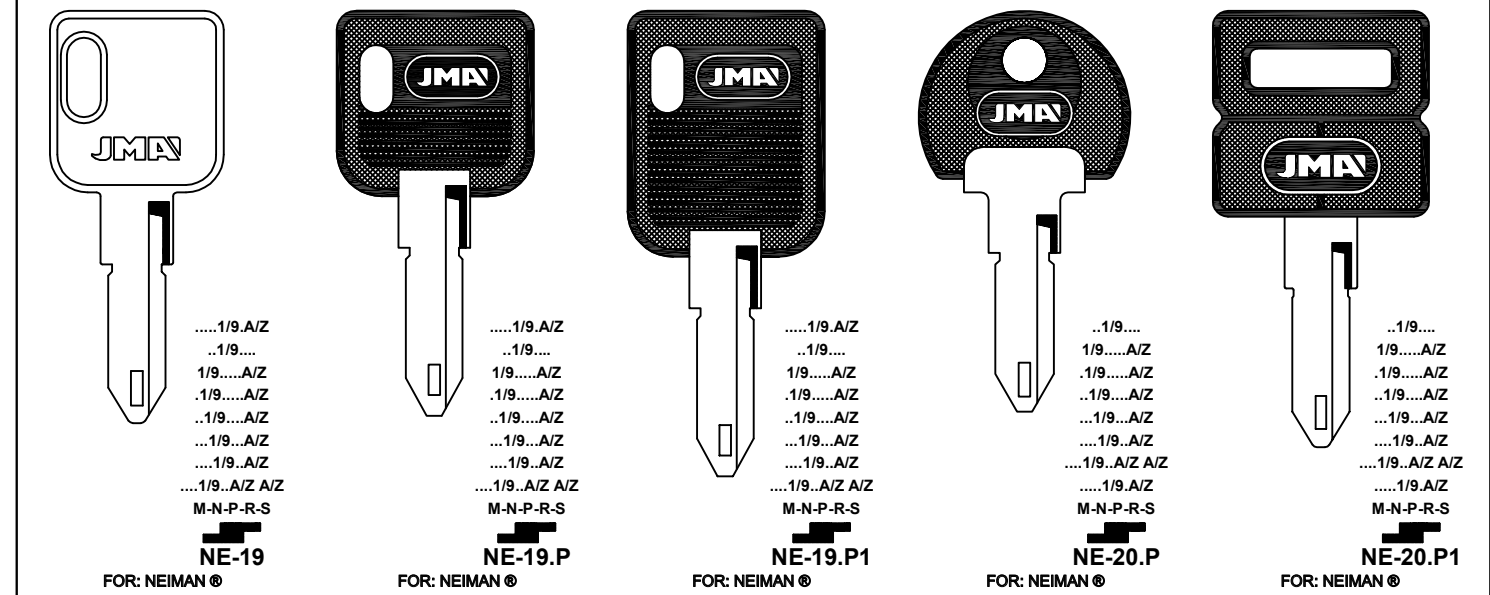

FOR: RENAULT®

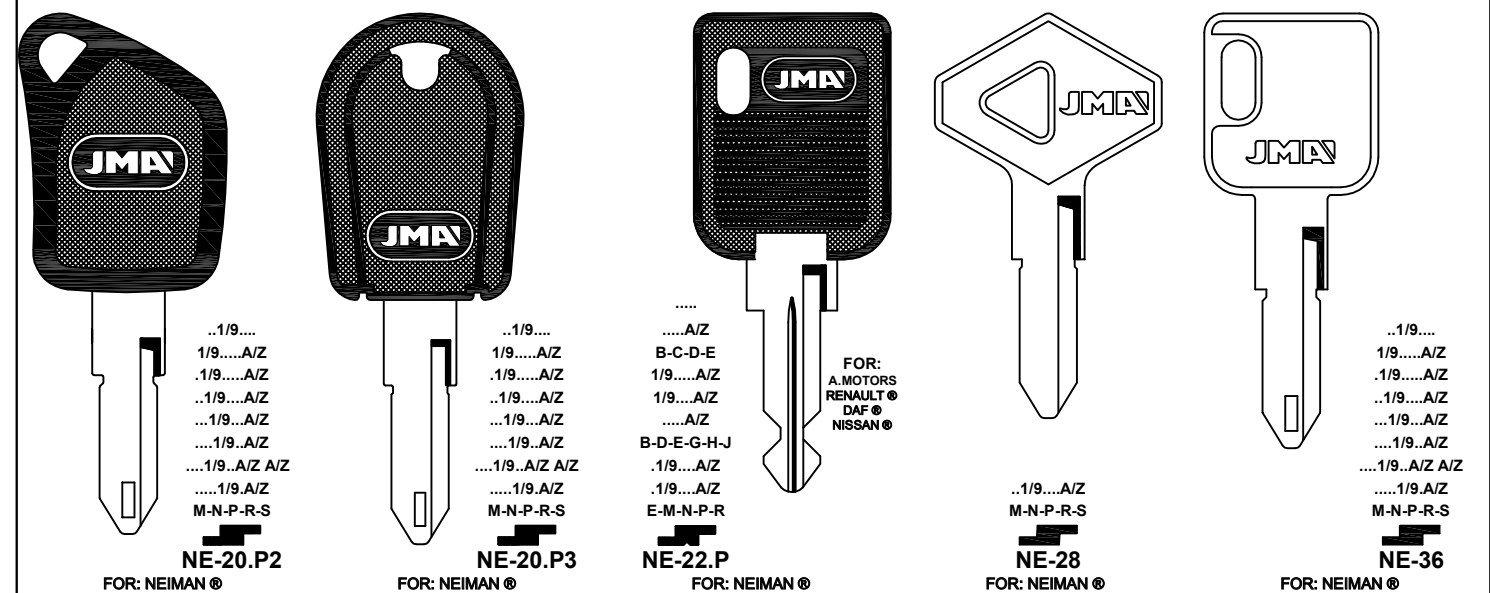

FOR: RENAULT®

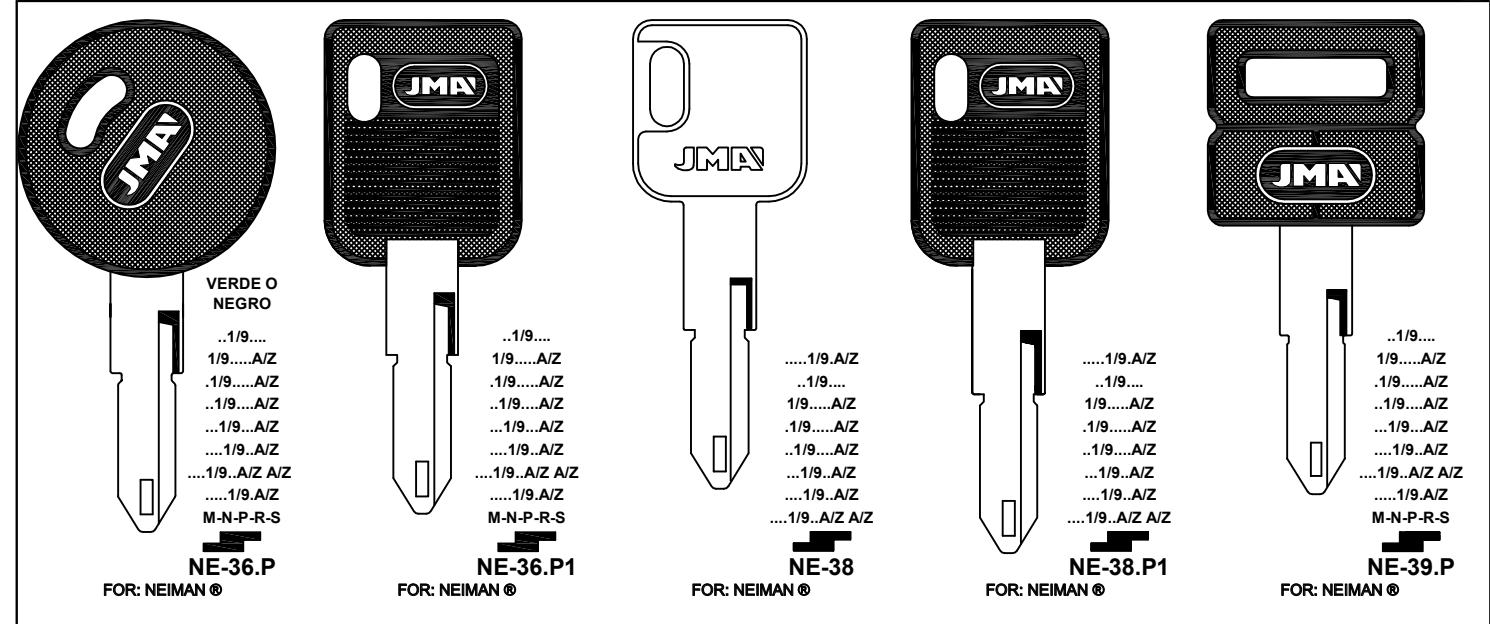

Concerning the marks and commercial denominations see legal warning.  
 Concerniente a las marcas y denominaciones comerciales ver aviso legal.  
 Marka eta izendapen komertzialiei dagokienez, ikus lege-oharra.  
 Concernant les marques et denominations commerciales voir la note dans l'index.

**JMA** Opening the future

**JMA** Opening the future

Beziehen auf die marke und handelsname sehen sie die notiz im Impressum.  
 Relativamente às marcas e denominações comerciais, ver aviso legal.  
 Jeśli chodzi o znaki i nazwy handlowe, patrz Informacje prawne.

FOR: RENAULT®

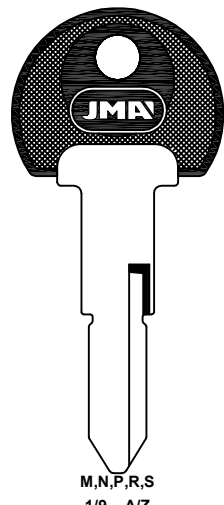

M,N,P,R,S  
1/9...A/Z

**NE-50.P**  
FOR: NEIMAN®

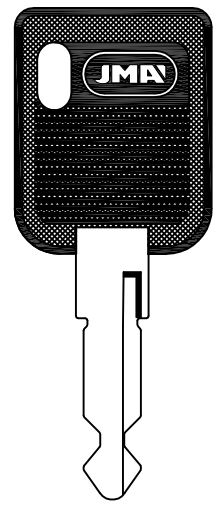

**NE-55.P**  
FOR: NEIMAN (RA)®

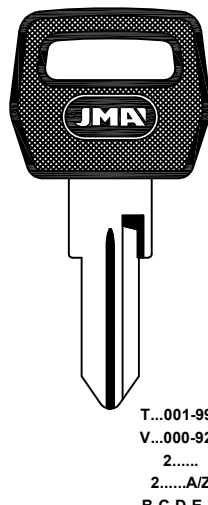

T...001-999  
V...000-922  
2.....  
2.....A/Z  
B-C-D-E-G

**NE-59.P**  
FOR: NEIMAN®  
FOR: CLAUSOR®

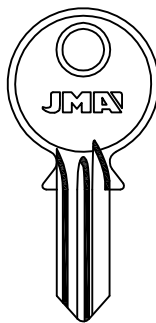

..4AB-ZZ  
S...331-348



**RO-2I**

AA-JZ  
A4...A.4.



**RO-4I**

AB-ZZ  
..6



**RO-6I**

A8..AA-DS  
..8AB-ZZ  
S...385-402



**RO-1I**

A9..AA-DS  
..8AB-ZZ  
S...403-420



**RO-1D**

..3AB-ZZ  
...1 AL 4



**RO-2D**

AA-JZ  
A3...A.3.  
S...213-246



**RO-4D**

AB-ZZ  
..7  
S...367-384



**RO-6D**

FOR: ABSA® -FROSER® -PJ® -SADV®  
FOR: RONIS®

FOR: RENAULT®

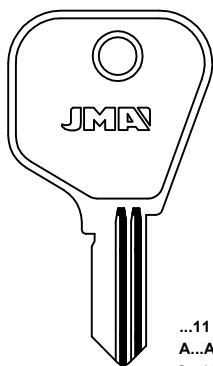

...11 1-700  
A...A1-700  
C...101-600  
D...1-1000  
T...1-380  
TA...1-224  
GV...1-300  
T...107-400  
Y...101-600

**RO-11I**  
FOR: RONIS®  
FOR: ABSA® -SADV® -SIMPLEX®

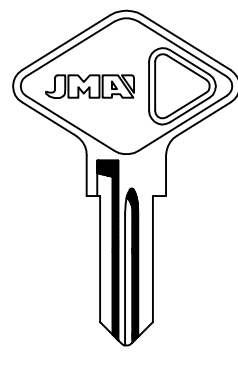

70.....  
1 AL 3  
...1-975

**RO-15**  
FOR: RONIS®

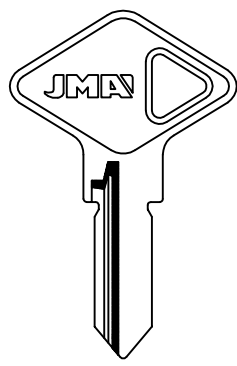

1R...000-999  
2R...1000-1837  
3R...000-665

**VA-7**  
FOR: VACHETTE®

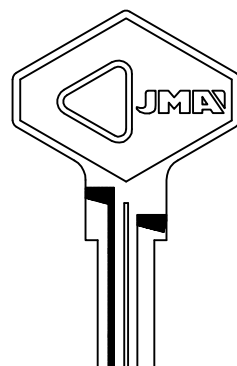

A/Z.....  
...A/Z  
...A/Z 1/9  
2700-4816

**VA-10**  
FOR: VACHETTE®

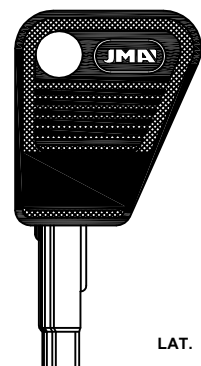

...A/Z  
A/Z...A/Z  
1000-2560  
.E...A/Z 0 AL 4

**VA-17.P**  
FOR: VACHETTE®  
FOR: NEIMAN®

FOR: RENAULT®

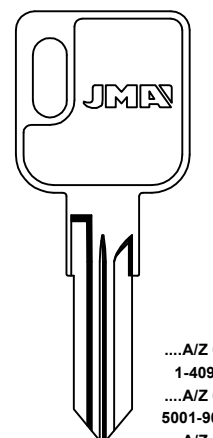

...A/Z 0/9  
1-4092  
...A/Z 0/9  
5001-9092  
...A/Z 0/9  
1-4092  
...A/Z 0/9  
5001-9092

**VA-34**  
FOR: VACHETTE®

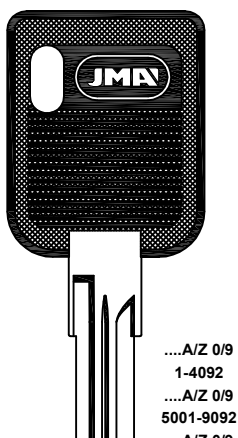

...A/Z 0/9  
1-4092  
...A/Z 0/9  
5001-9092  
...A/Z 0/9  
1-4092  
...A/Z 0/9  
5001-9092

**VA-34.P**  
FOR: VACHETTE®

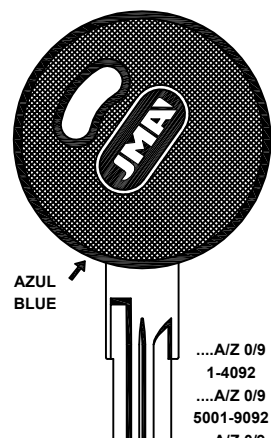

AZUL  
BLUE

...A/Z 0/9  
1-4092  
...A/Z 0/9  
5001-9092  
...A/Z 0/9  
1-4092  
...A/Z 0/9  
5001-9092

**VA-34.P1**  
FOR: VACHETTE®

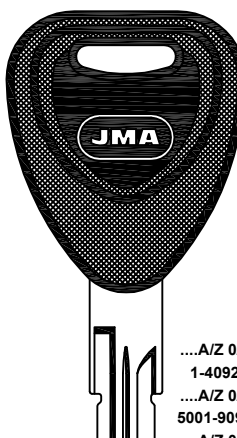

...A/Z 0/9  
1-4092  
...A/Z 0/9  
5001-9092  
...A/Z 0/9  
1-4092  
...A/Z 0/9  
5001-9092

**VA-34.P2**  
FOR: VACHETTE®

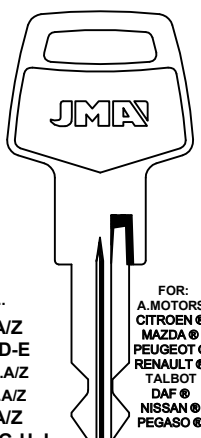

.....  
...A/Z  
B-C-D-E  
1/9...A/Z  
1/9...A/Z  
...A/Z  
B-D-E-G-H-J  
.1/9...A/Z  
.1/9...A/Z  
E-M-N-P-R

**CHR-3**  
FOR: CHRYSLER®  
FOR: CLAUSOR® -NEIMAN®

FOR: RENAULT(ARG.)®

FOR: RENAULT (ARGENTINA)®

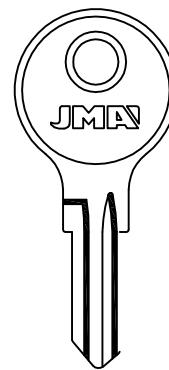

**GAS-1**  
FOR: GAS®

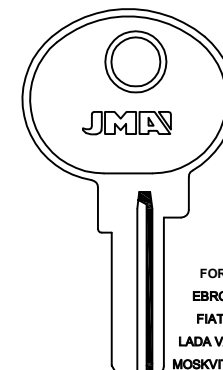

**GAS-1D**  
FOR: GAS®

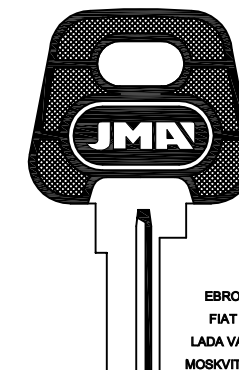

...A/Z  
A/Z.....  
A/Z...A/Z  
1 AL 7  
...A/Z  
0 AL 9

**NE-3.P**  
FOR: NEIMAN®  
FOR: CLAUSOR®

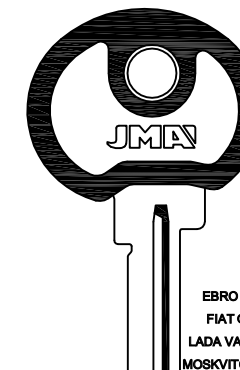

...A/Z  
A/Z.....  
A/Z...A/Z  
1 AL 7  
...A/Z  
0 AL 9

**NE-3.P2**  
FOR: NEIMAN®  
FOR: CLAUSOR®

FOR: RENAULT (ARGENTINA)®

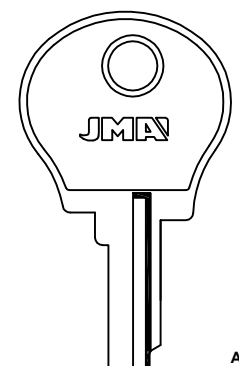

.A/Z.....  
.A/Z...A/Z  
A/Z...A/Z  
0 AL 8  
1 AL 7  
A/Z...1 AL 7 Y A AL E



**NE-4**

11-34-39...  
1 AL 7  
34-39...A/Z  
1 AL 7

**NE-15I**

FOR: NEIMAN®  
FOR: CLAUSOR®

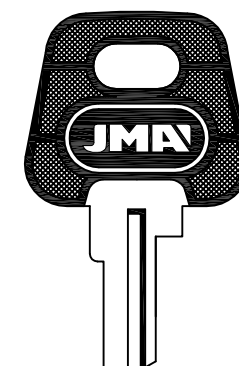

**NE-4D**

11-34-39...  
1 AL 7  
34-39...A/Z  
1 AL 7

**NE-15D**

FOR: NEIMAN®  
FOR: CLAUSOR®

FOR: RENAULT (ARGENTINA)®

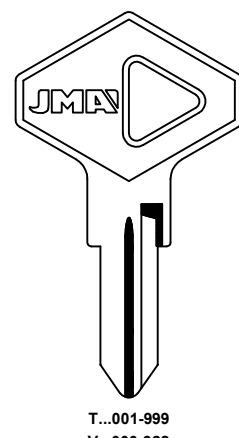

T...001-999  
V...000-922  
2.....  
2.....A/Z  
B-C-D-E-G

**NE-16**  
FOR: NEIMAN®  
FOR: CLAUSOR®

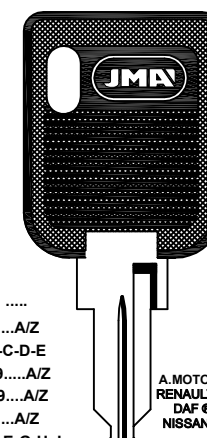

...A/Z  
B-C-D-E  
1/9...A/Z  
1/9...A/Z  
...A/Z  
B-D-E-G-H-J  
.1/9...A/Z  
.1/9...A/Z  
E-M-N-P-R

**NE-22.P**  
FOR: NEIMAN®  
FOR: CLAUSOR®

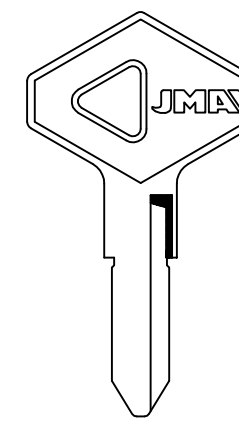

.1/9...A/Z  
M-N-P-R-S

**NE-28**  
FOR: NEIMAN®

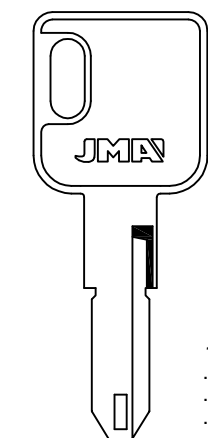

..1/9....  
1/9...A/Z  
..1/9...A/Z  
..1/9...A/Z  
...1/9...A/Z  
...1/9...A/Z  
...1/9...A/Z  
...1/9...A/Z  
M-N-P-R-S

**NE-36**  
FOR: NEIMAN®

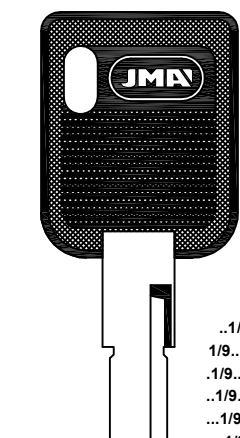

..1/9....  
1/9...A/Z  
..1/9...A/Z  
..1/9...A/Z  
...1/9...A/Z  
...1/9...A/Z  
...1/9...A/Z  
...1/9...A/Z  
M-N-P-R-S

**NE-36.P1**  
FOR: NEIMAN®

Concerning the marks and commercial denominations see legal warning.  
Concerniente a las marcas y denominaciones comerciales ver aviso legal.  
Marka eta izendapen komertzialiei dagokienez, ikus lege-oharra.  
Concernant les marques et denominations commerciales voir la note dans l'index.

**JMA** Opening the future

**JMA** Opening the future

Beziehen auf die marke und handelsname sehen sie die notiz im Impressum.  
Relativamente às marcas e denominações comerciais, ver aviso legal.  
Jeśli chodzi o znaki i nazwy handlowe, patrz Informacje prawne.

**K04** / 261



FOR: RENAULT (ARGENTINA) ®

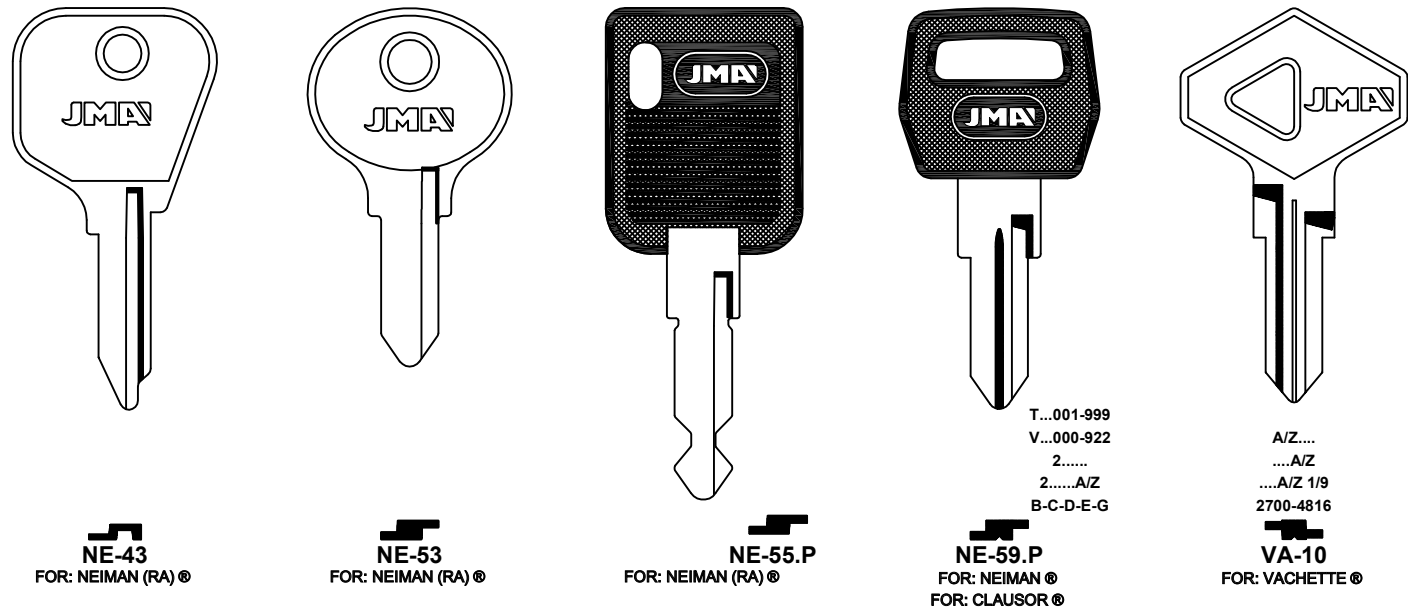

FOR: RENAULT SAVIEM ®

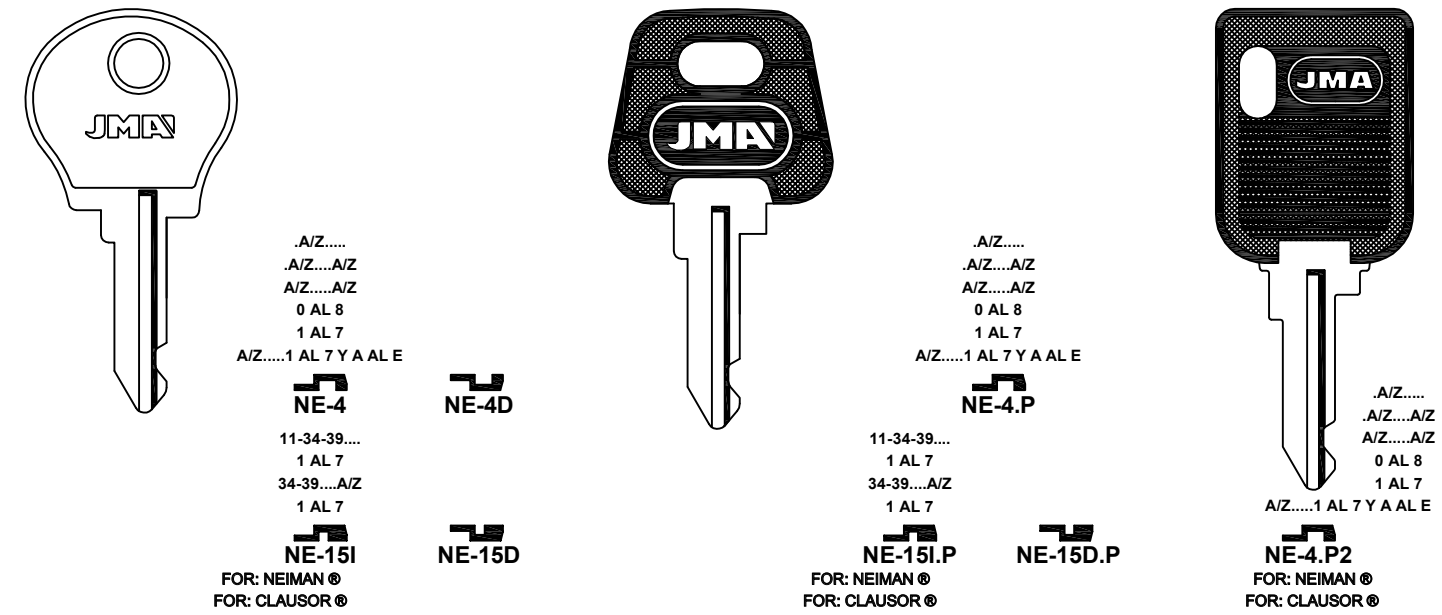

FOR: RENAULT DACIA ®

FOR: RENAULT SAVIEM ®

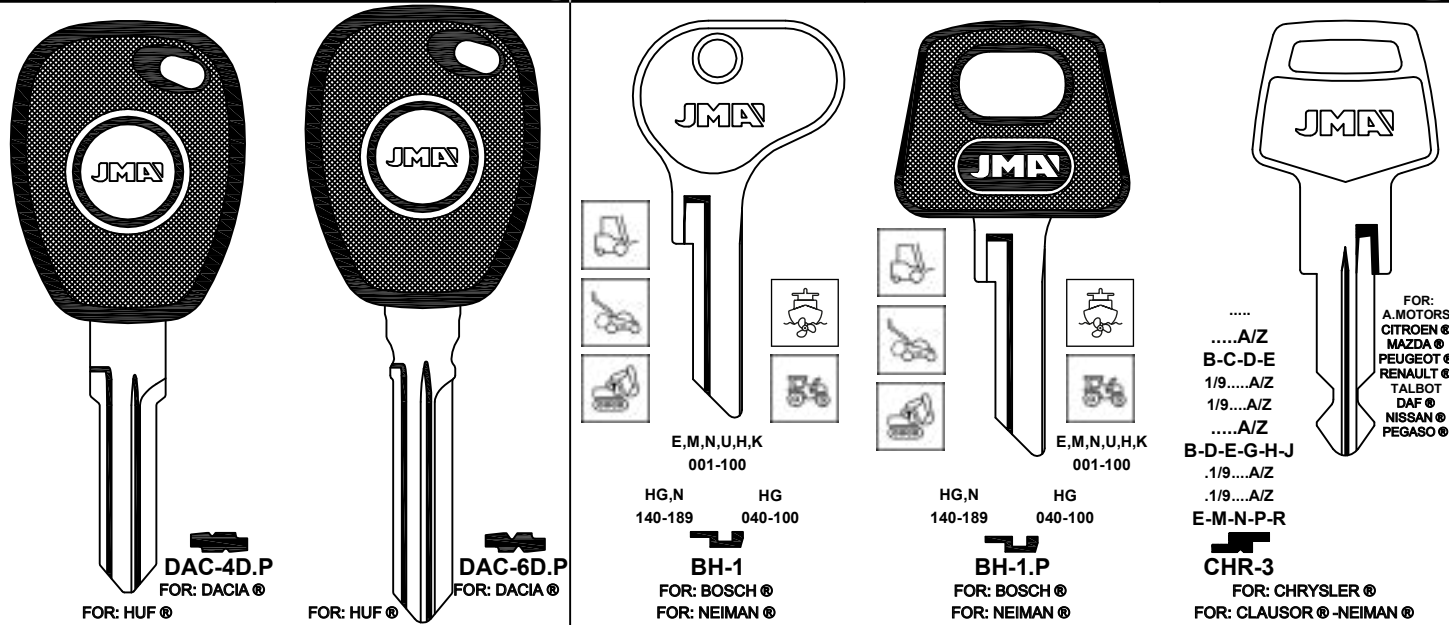

FOR: RENAULT SAVIEM ®

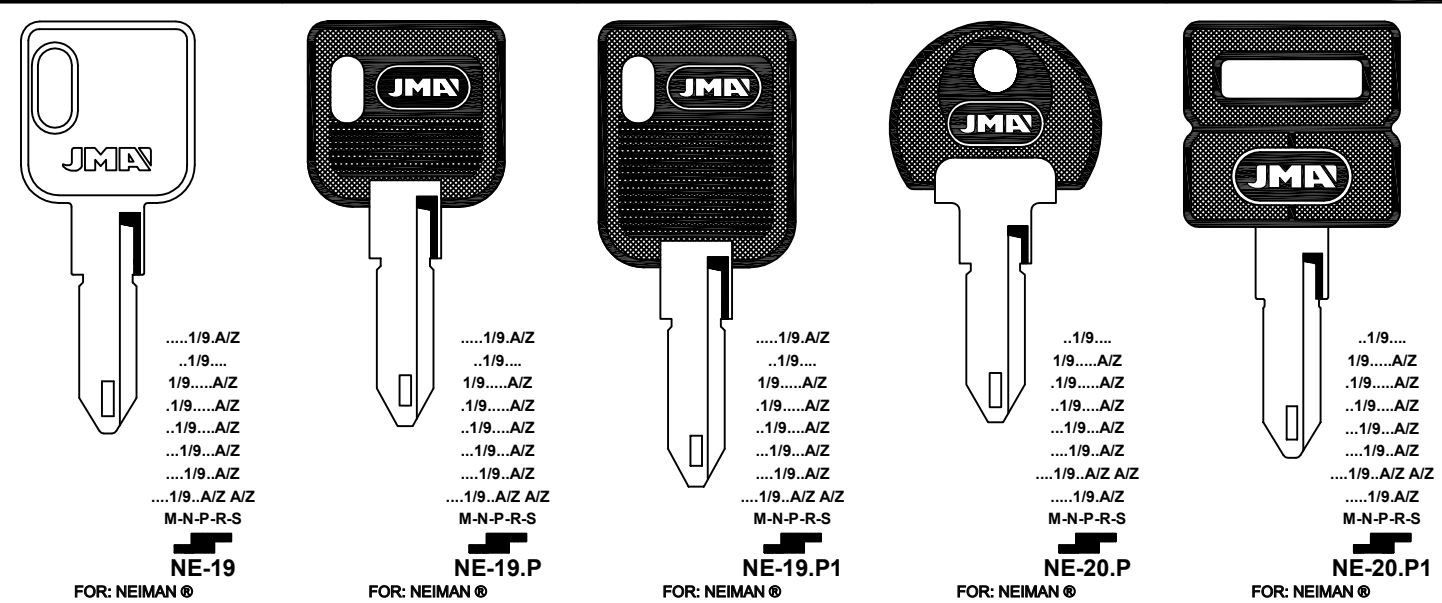

FOR: RENAULT SAVIEM ®

FOR: RENAULT SAVIEM ®

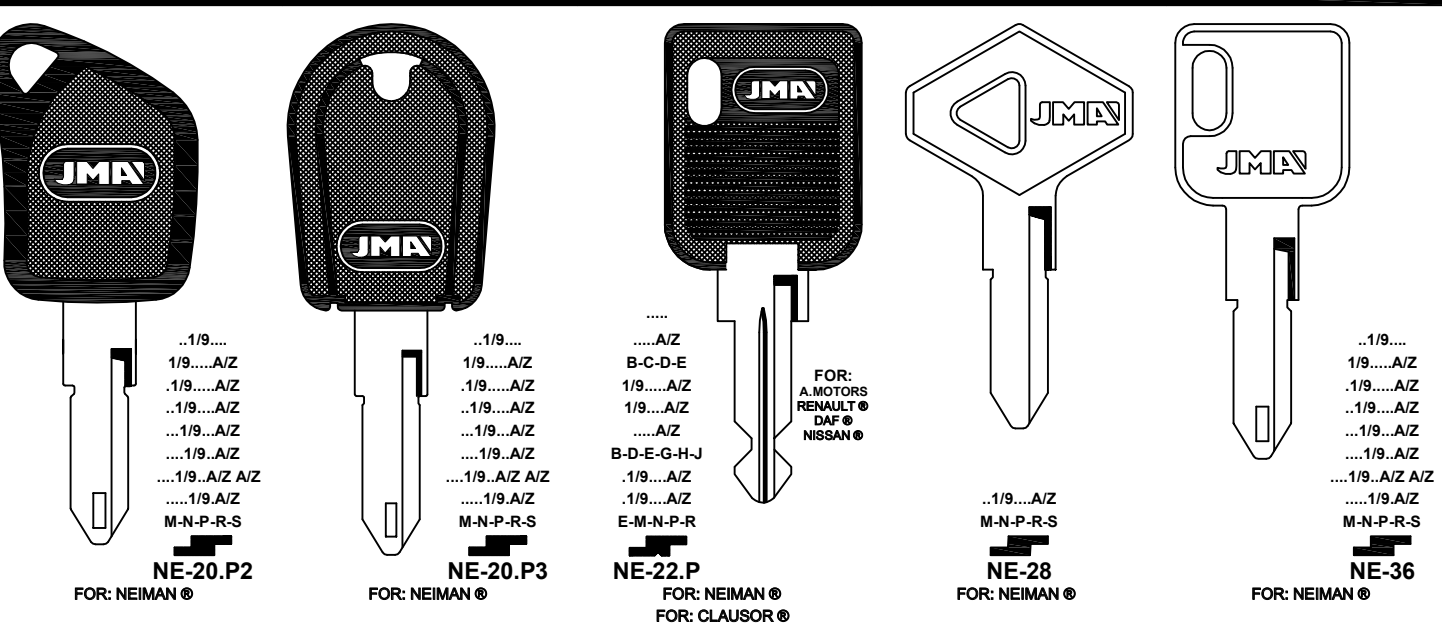
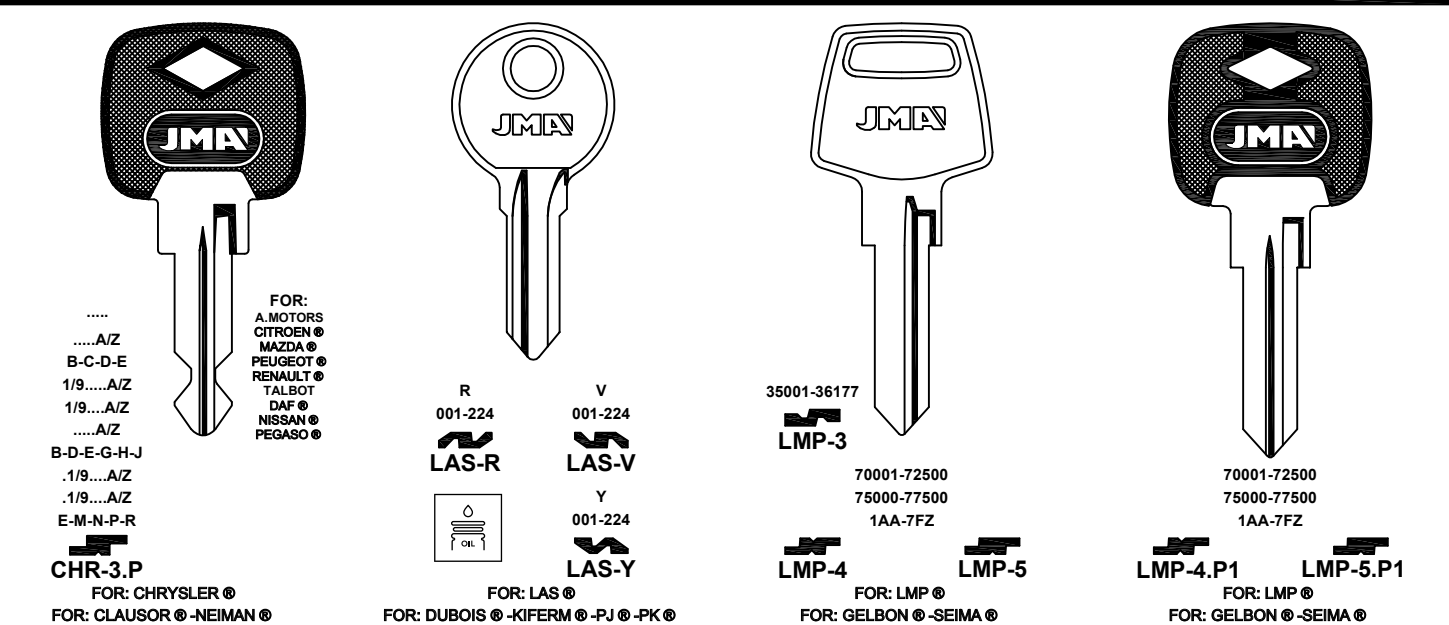

Concerning the marks and commercial denominations see legal warning.  
Concerniente a las marcas y denominaciones comerciales ver aviso legal.  
Marka eta izendapen komertzialiei dagokienez, ikus lege-oharra.  
Concernant les marques et denominations commerciales voir la note dans l'index.

**JMA** Opening the future

**JMA** Opening the future

Beziehen auf die marke und handelsname sehen sie die notiz im Impressum.  
Relativamente às marcas e denominações comerciais, ver aviso legal.  
Jeśli chodzi o znaki i nazwy handlowe, patrz Informacje prawne.





FOR: ROVER®

**NE-11.P1**  
 FOR: NEIMAN®  
 NSP...  
 4000-4999  
 7001-9000  
 E...  
 2001-3000  
 4001-5000  
 S...  
 2001-3000

**NE-11.P2**  
 FOR: NEIMAN®  
 NSP...  
 4000-4999  
 7001-9000  
 E...  
 2001-3000  
 4001-5000  
 S...  
 2001-3000

**NE-14**  
 FOR: NEIMAN®  
 FOR: CEM®  
 NP...  
 1-1000

**NE-24.P**  
 FOR: NEIMAN®  
 NSP...  
 4000-4999  
 7001-9000  
 E...  
 2001-3000  
 4001-5000  
 S...  
 2001-3000

FOR: ROVER®

**NE-24.P1**  
 FOR: NEIMAN®  
 NSP...  
 4000-4999  
 7001-9000  
 E...  
 2001-3000  
 4001-5000  
 S...  
 2001-3000

**NE-35**  
 FOR: NEIMAN®  
 R...  
 E...  
 4001-5000  
 S...  
 8001-10000

**NE-35.P**  
 FOR: NEIMAN®  
 R...  
 E...  
 4001-5000  
 S...  
 8001-10000

**NE-35.P2**  
 FOR: NEIMAN®  
 R...  
 E...  
 4001-5000  
 S...  
 8001-10000

FOR: ROVER®

**NE-52.P**  
 FOR: NEIMAN®  
 L...  
 8001-10000

**PJ-2**  
 FOR: PJ®  
 FOR: KIFERM®  
 J...  
 001-224

**PJ-2.P**  
 FOR: PJ®  
 FOR: KIFERM®  
 J...  
 001-224

**PJ-K**  
 FOR: PJ®  
 K...4-6-8  
 K...4-6-8-A-B-C

FOR: ROVER®

**UN-FFE**  
 FOR: UNION®  
 NRA  
 FFE...1-100  
 FJA...1-100  
 FL...251-500  
 NRA...51-90  
 YFB...1-75  
 FMD...1-75  
 FG...1-30  
 NF...1-30  
 EJR...1-75

**UN-3**  
 FOR: UNION®  
 FP...  
 626-750  
 UN-FP

**UN-MRN**  
 FOR: UNION®  
 MC...1-40  
 MRA...251-290  
 MRN...1-54  
 MRN...201-250  
 MRN...251-300

**UN-2**  
 FOR: UNION®  
 HX...100  
 UN-2

**UN-FR**  
 FOR: UNION®  
 FR...  
 751-875  
 UN-FR

**UN-1FS**  
 FOR: UNION®  
 FS...1-99  
 FS...876-955

**UN-44**  
 FOR: UNION®  
 FA...  
 501-625

**UN-44D**  
 FOR: UNION®  
 RM...  
 911-952

**UN-NG**  
 FOR: UNION®  
 NGN...1-54

**UN-FK**  
 FOR: UNION®  
 FOR: WBH®  
 FK...  
 01-99  
 876-955

**UN-FS**  
 FOR: UNION®  
 FS...  
 01-99  
 876-955

**UN-FT**  
 FOR: UNION®  
 FT-BC...301-360  
 BC-FT...101-225  
 LF...451-575

**UN-TF**  
 FOR: UNION®  
 FOR: CEM®  
 TF...1001-1140

FOR: ROVER®

**WAS-1**  
 FOR: WASO®  
 W...  
 600-842

**AS-11**  
 FOR: ASSA®  
 8...  
 1...  
 1001-3300

FOR: SAAB®

**SAA-1.P1**  
 FOR: SAAB®  
 FOR: YMOS®  
 6,7  
 2,95

**SAA-2.P**  
 FOR: SAAB®  
 42...  
 1001-2000

**SAA-AC**  
 FOR: SAAB®  
 FOR: YMOS®  
 AC  
 1-3192

FOR: SAAB®

**SAA-AC.P**  
 FOR: SAAB®  
 FOR: YMOS®  
 AC  
 1-3192

**WAS-1**  
 FOR: WASO®  
 W...  
 600-842

FOR: SCION®

**TOYO-30.P1**  
 FOR: TOYOTA®  
 LAT.  
 7,8  
 3

FOR: SEAT®

**AF-71**  
 FOR: SAFE®  
 FOR: SAFE®  
 FOR: CROMODORA®  
 FIST®  
 FREA®  
 GIOBERT®  
 MIRAGLIO®  
 RUFFINI®  
 6  
 100-309  
 AF-5I  
 2  
 100-309  
 AF-6I

**AF-7D**  
 FOR: SAFE®  
 A  
 0501-3278  
 0,4,6,8,9  
 AF-7I  
 H  
 O1-78  
 AF-8I  
 F  
 O1-78  
 AF-9I

**AF-7D**  
 FOR: SAFE®  
 G  
 O1-78  
 AF-8D  
 E  
 O1-78  
 AF-9D

Concerning the marks and commercial denominations see legal warning.  
 Concerniente a las marcas y denominaciones comerciales ver aviso legal.  
 Marka eta izendapen komertzialiei dagokienez, ikus lege-oharra.  
 Concernant les marques et denominations commerciales voir la note dans l'index.







FOR: SKODA ®

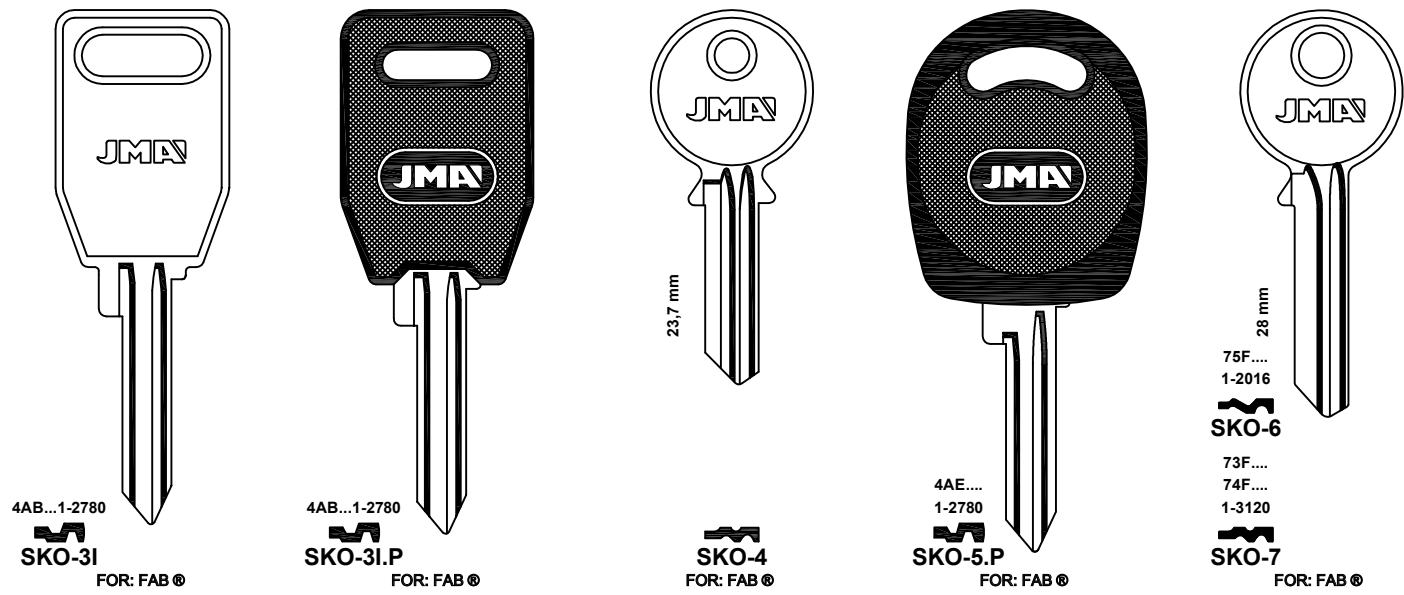

FOR: STEYR-PUCH ®

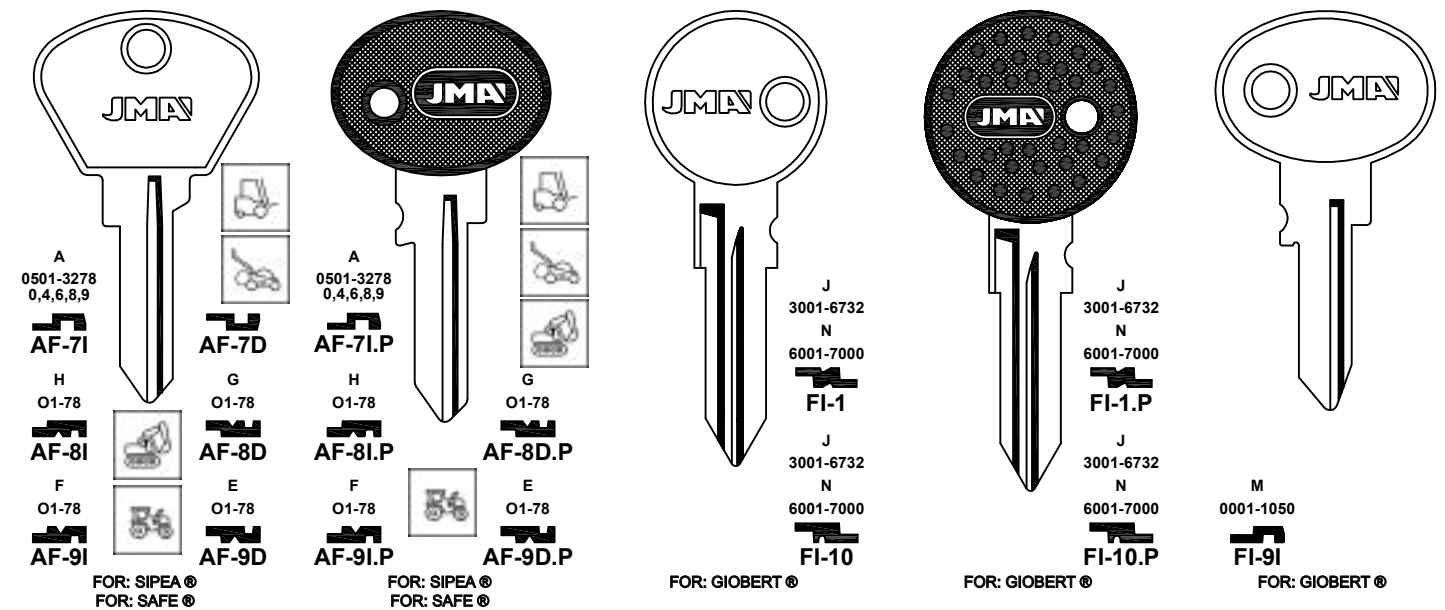

FOR: SKODA ®

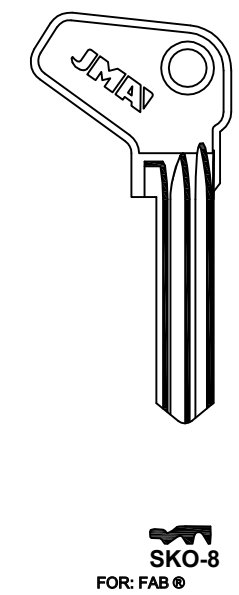

FOR: SSANGYONG ®

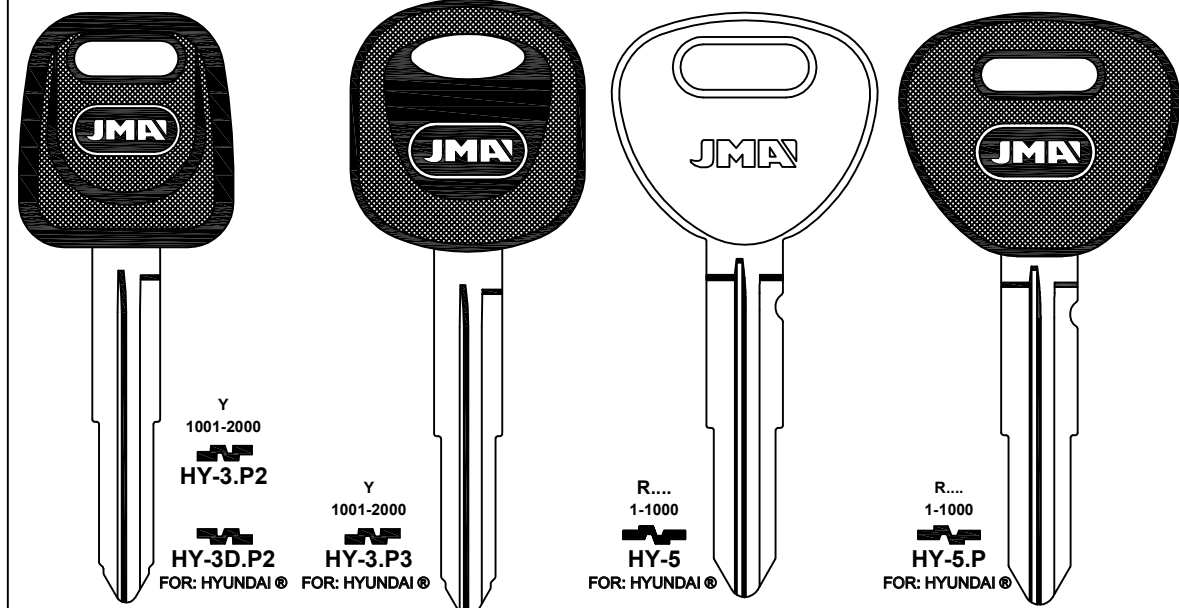

FOR: STEYR-PUCH ®

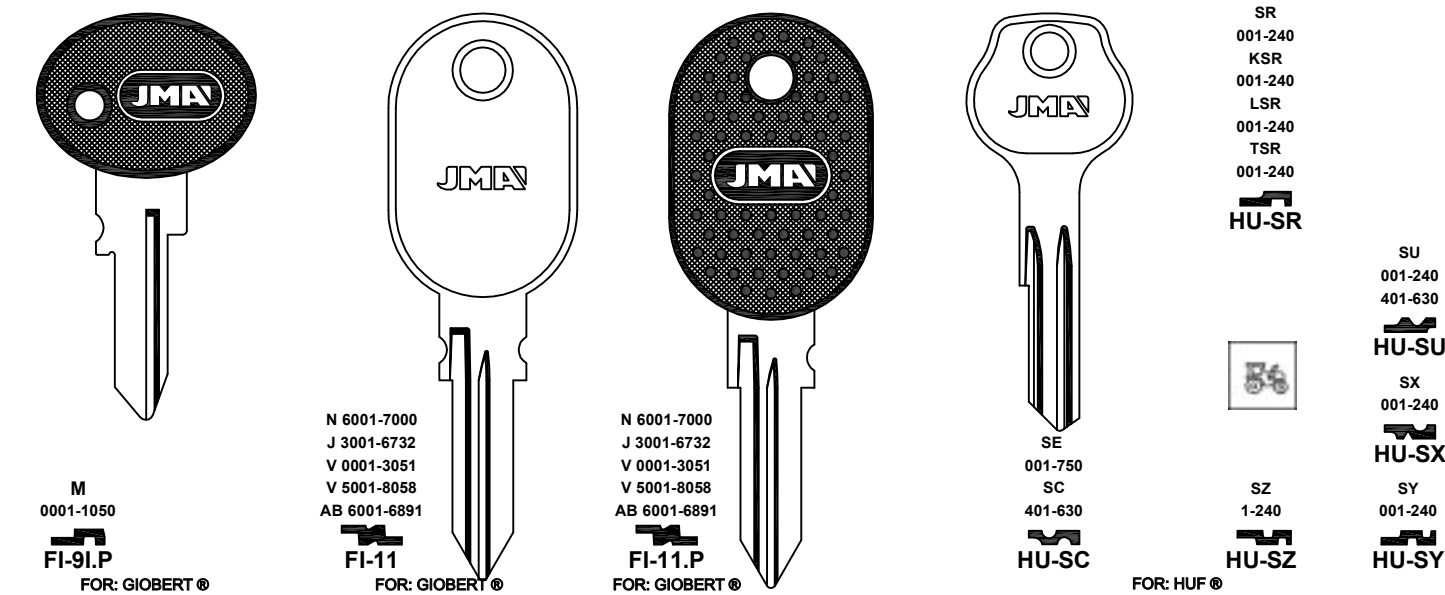

FOR: SSANGYONG ®

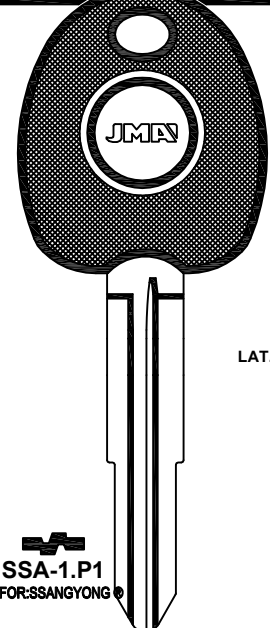

FOR: STERLING ®

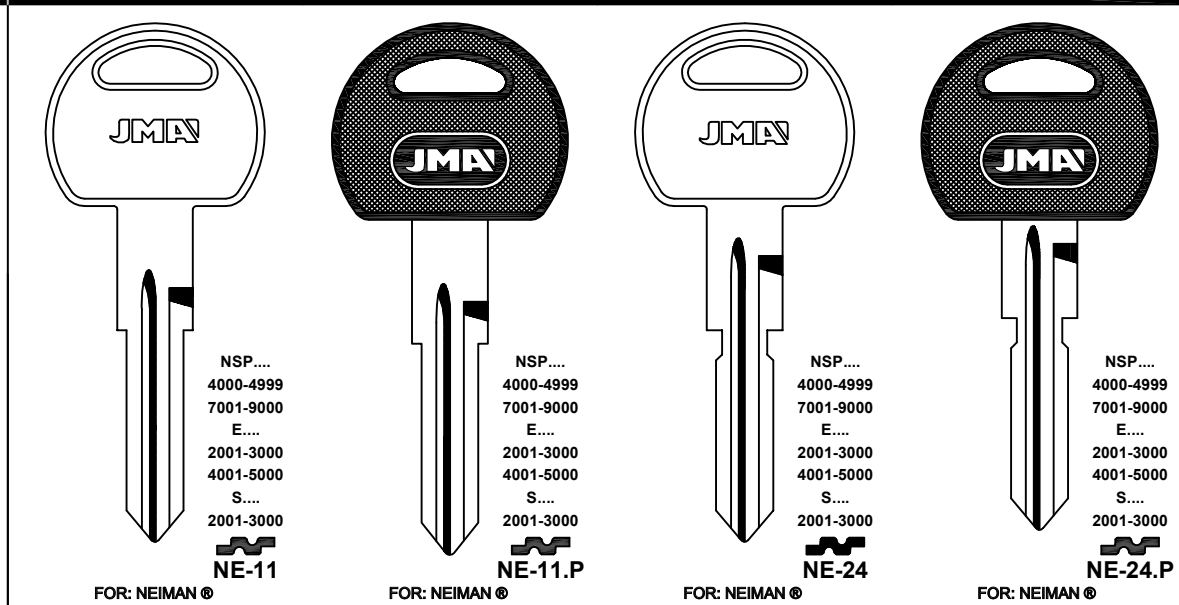

FOR: STEYR-PUCH ®

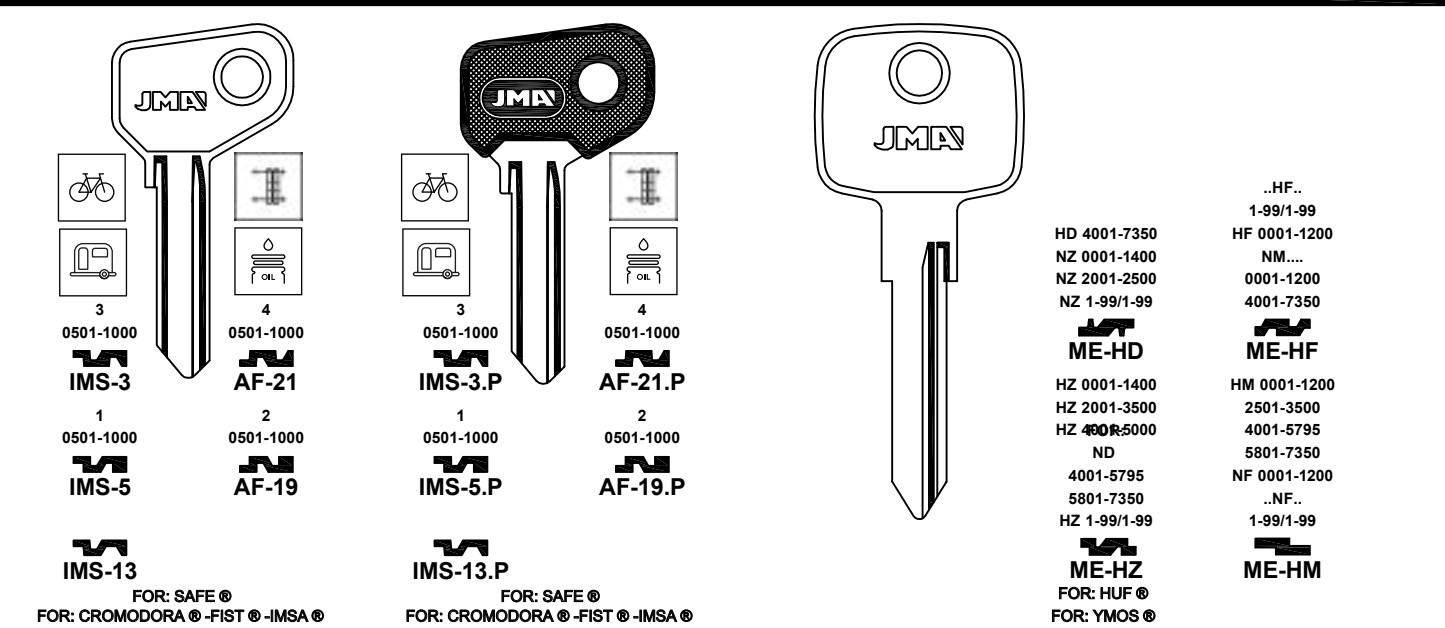

Concerning the marks and commercial denominations see legal warning.  
 Concerniente a las marcas y denominaciones comerciales ver aviso legal.  
 Marka eta izendapen komertzialiei dagokienez, ikus lege-oharra.  
 Concernant les marques et denominations commerciales voir la note dans l'index.

**JMA** Opening the future

**JMA** Opening the future

Beziehen auf die marke und handelsname sehen sie die notiz im Impressum.  
 Relativamente às marcas e denominações comerciais, ver aviso legal.  
 Jeśli chodzi o znaki i nazwy handlowe, patrz Informacje prawne.

FOR: STEYR-PUCH®

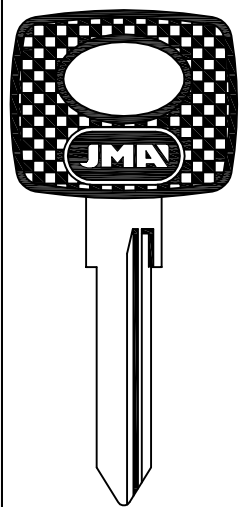

..HF..  
1-99/1-99  
HD 4001-7350  
NZ 0001-1400  
NZ 2001-2500  
NZ 1-99/1-99

**ME-HD.P**

HZ 0001-1400  
HZ 2001-3500  
HZ 4001-5000  
ND  
4001-5795  
5801-7350  
HZ 1-99/1-99

**ME-HZ.P**  
FOR: HUF®  
FOR: YMOS®

..HF..  
1-99/1-99  
HF 0001-1200  
NM....  
0001-1200  
4001-7350

**ME-HF.P**

HM 0001-1200  
2501-3500  
4001-5795  
5801-7350  
NF 0001-1200  
..NF..  
1-99/1-99

**ME-HM.P**

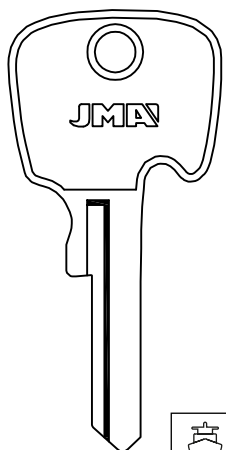

N....1 AL 5  
**NE-58D**  
FOR: NEIMAN®  
FOR: BOMORO® -BOSCH®

FOR: SUBARU®

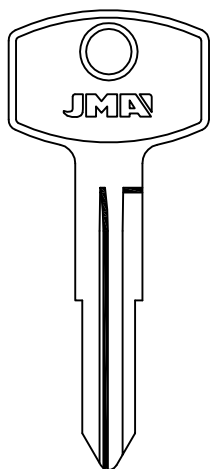

F  
0001-1000  
1001-2000

M  
4001-5000

**DAT-11**

M  
6001-7000  
W  
0001-1000

**DAT-21**

M  
0001-1000  
5001-6000

N  
1001-2000

**DAT-1D**

M  
7001-8000

**DAT-2D**

FOR: NISSAN®  
FOR: DATSUN® -WASO®

FOR: SUBARU®

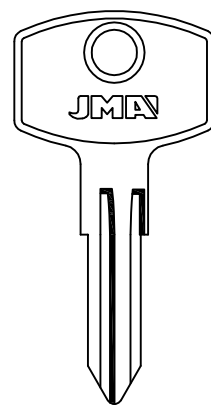

F  
0001-1000  
1001-2000

M  
4001-5000

**DAT-8I**

M  
6001-7000  
7001-800

W  
0001-1000

**DAT-9I**

FOR: NISSAN®  
FOR: DATSUN®

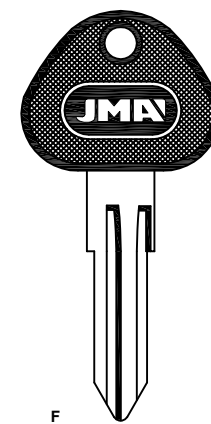

F  
0001-1000  
1001-2000

M  
4001-5000

**DAT-8I.P1**

FOR: NISSAN®  
FOR: DATSUN®



F  
0001-1000  
1001-2000

M  
4001-5000

**DAT-8I.P**

M  
6001-7000  
7001-800

W  
0001-1000

**DAT-9I.P**

FOR: NISSAN®  
FOR: DATSUN®

M  
0001-1000  
5001-6000

N  
1001-2000

**DAT-8.P**

M  
7001-800

**DAT-9D.P**

FOR: SUBARU®

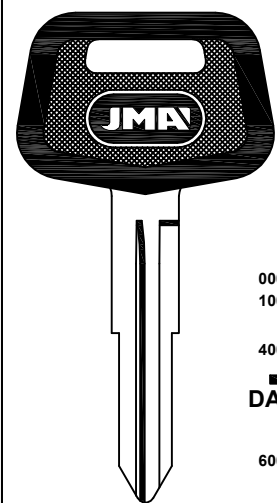

F  
0001-1000  
1001-2000

M  
4001-5000

**DAT-11.P**

M  
6001-7000  
W  
0001-1000

**DAT-21.P**

FOR: NISSAN®  
FOR: DATSUN® -WASO®

M  
0001-1000  
5001-6000

N  
1001-2000

**DAT-1D.P**

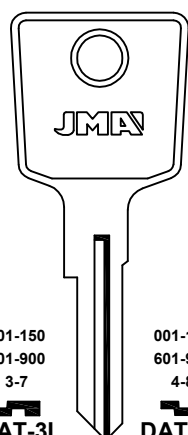

001-150  
601-900  
3-7

**DAT-3I**

001-150  
601-900  
1-5

**DAT-4I**

FOR: NISSAN®  
FOR: DATSUN®

001-150  
601-900  
4-8

**DAT-3D**

001-150  
601-900  
6-9

**DAT-4D**

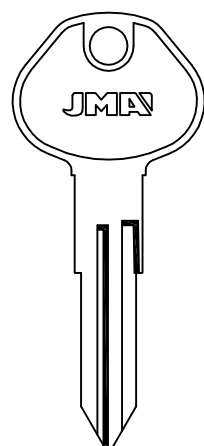

X  
0001-8000

**DAT-6**

**DAT-6D**

Y  
0001-8000  
8001-9000

**DAT-7**

FOR: NISSAN®  
FOR: DATSUN®

FOR: SUBARU®

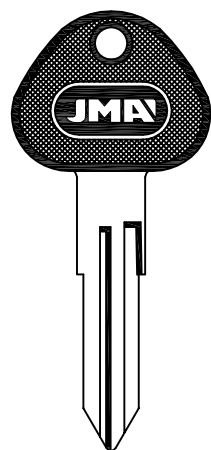

X  
0001-8000

**DAT-6.P**

**DAT-6D.P**

Y  
0001-8000  
8001-9000

**DAT-7.P**

FOR: NISSAN®  
FOR: DATSUN®

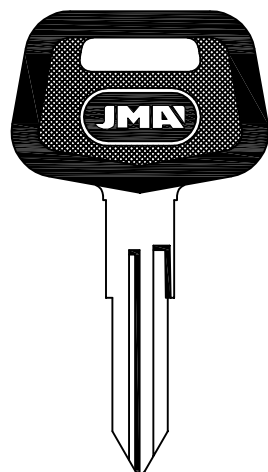

X  
0001-8000

**DAT-6.P1**

**DAT-6D.P1**

Y  
0001-8000  
8001-9000

**DAT-7.P1**

FOR: NISSAN®  
FOR: DATSUN®

FOR: SUBARU®

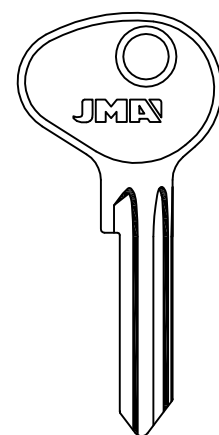

VH  
0001-3948

K  
00001-14000

**DAT-11**

FOR: NISSAN®  
FOR: DATSUN® -WASO®

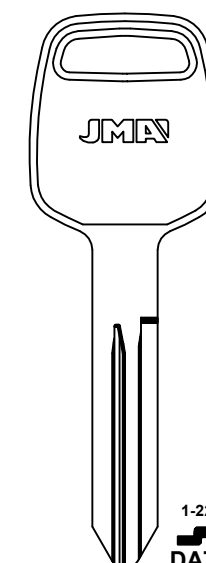

1-22185

**DAT-15**

FOR: NISSAN®

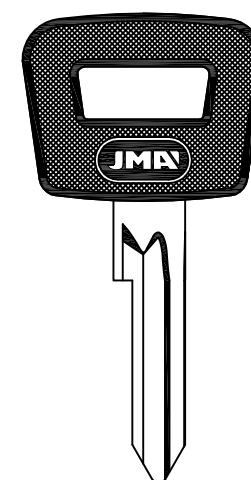

FR...4001-6000  
FZ...1-1232

**WAS-2.P**

FOR: WASO®  
FOR: ARMAN® -DOM®

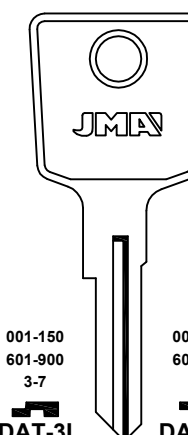

001-150  
601-900  
3-7

**DAT-3I**

001-150  
601-900  
1-5

**DAT-4I**

FOR: NISSAN®  
FOR: DATSUN®

001-150  
601-900  
4-8

**DAT-3D**

001-150  
601-900  
6-9

**DAT-4D**

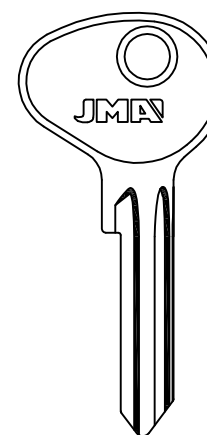

VH  
0001-3948

K  
00001-14000

**DAT-11**

FOR: NISSAN®  
FOR: DATSUN® -WASO®

FOR: SUBARU®

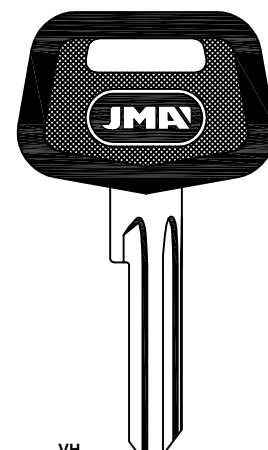

VH  
0001-3948

K  
00001-14000

**DAT-11.P**

FOR: NISSAN®  
FOR: DATSUN® -WASO®

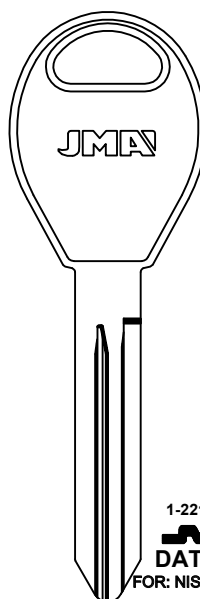

1-22185

**DAT-16**

FOR: NISSAN®

T...1-3000

**SUB-2.P**

FOR: SUBARU®

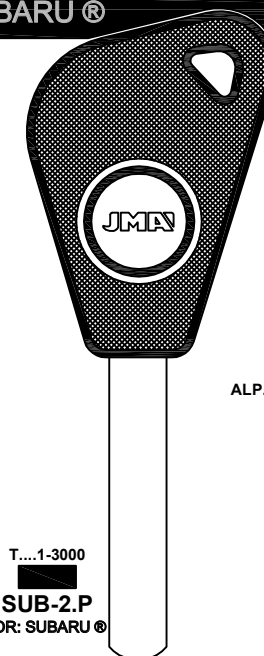

ALP.

LAT.

7.8

**TOYO-30.P1**

FOR: TOYOTA®

FOR: SULKY®

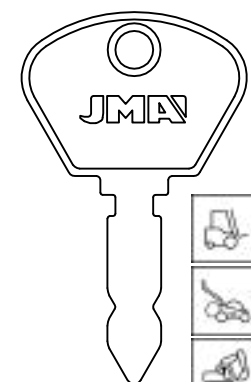

7.1

1.95

**BH-4**

FOR: BOSCH®  
FOR: KOLB® -POLAR®

Concerning the marks and commercial denominations see legal warning.  
Concerniente a las marcas y denominaciones comerciales ver aviso legal.  
Marka eta izendapen komertzialiei dagokienez, ikus lege-oharra.  
Concernant les marques et denominations commerciales voir la note dans l'index.

**JMA** Opening the future

**JMA** Opening the future

Beziehen auf die Marke und Handelsname sehen Sie die Notiz im Impressum.  
Relativamente às marcas e denominações comerciais, ver aviso legal.  
Jeśli chodzi o znaki i nazwy handlowe, patrz Informacje prawne.



FOR: SULKY®

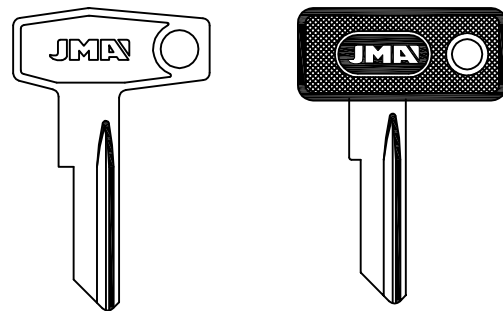

.....1-1625  
.....5001-6278  
E...1-710

**ZA-1**  
FOR: ZADI®  
FOR: BRETER®

**ZA-1.P**  
FOR: ZADI®  
FOR: BRETER®

FOR: SUNBEAM®

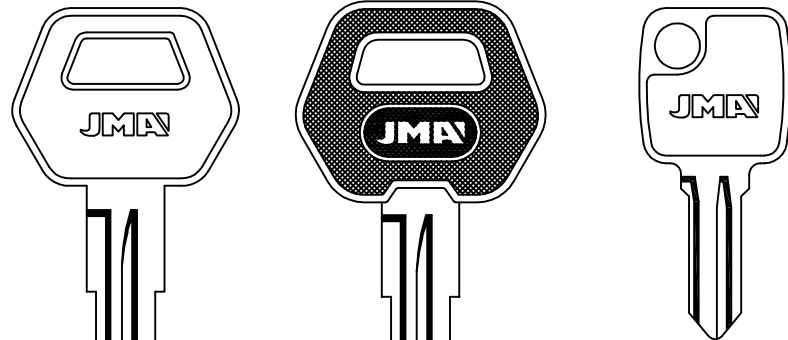

SL  
5001-7000  
**LF-SL**  
FOR: L. & F.®  
FOR: ROOTES®

SL  
5001-7000  
**LF-SL.P**  
FOR: L. & F.®  
FOR: ROOTES®

J...  
001-224  
**PJ-2**  
FOR: PJ®  
FOR: KIFERM®

FOR: SUZUKI®

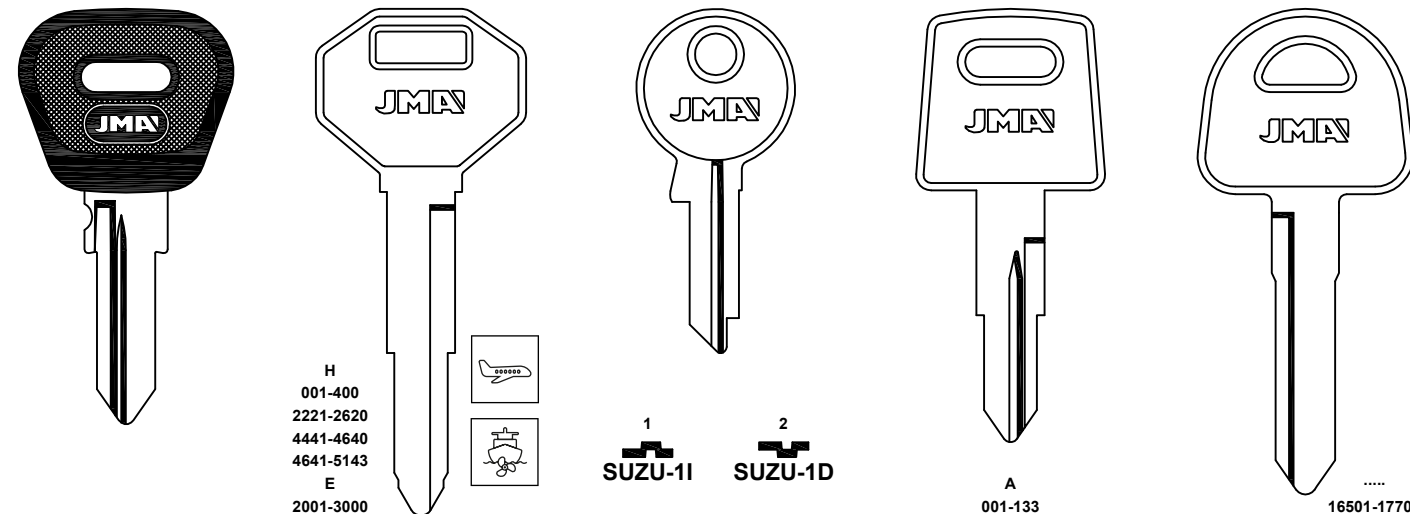

H  
001-400  
2221-2620  
4441-4640  
4641-5143  
E  
2001-3000

**IMS-11.P**  
FOR: IMSA®

**MIT-2I**  
FOR: MITSUBISHI®

**MIT-2D**  
FOR: MITSUBISHI®

1  
**SUZU-1I**

2  
**SUZU-1D**

A  
001-133  
**SUZU-6**  
FOR: SUZUKI®

.....  
16501-17704  
**SUZU-7**  
FOR: SUZUKI®

.....  
16501-17704  
**SUZU-7.P**  
FOR: SUZUKI®

.....  
18100-19229  
**SUZU-8I**  
FOR: SUZUKI®

.....  
18100-19229  
**SUZU-8**

.....  
18100-19229  
**SUZU-8I.P**  
FOR: SUZUKI®

.....  
18100-19229  
**SUZU-8.P**  
FOR: SUZUKI®

.....  
1 AL 5  
**SUZU-9.P**  
FOR: SUZUKI®  
FOR: CLAUSOR®

U...  
1-2000  
**SUZU-10**  
FOR: SUZUKI®

FOR: SUNBEAM®

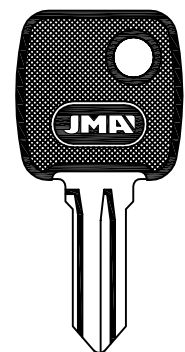

J...  
001-224  
**PJ-2.P**  
FOR: PJ®  
FOR: KIFERM®

FOR: SUZUKI®

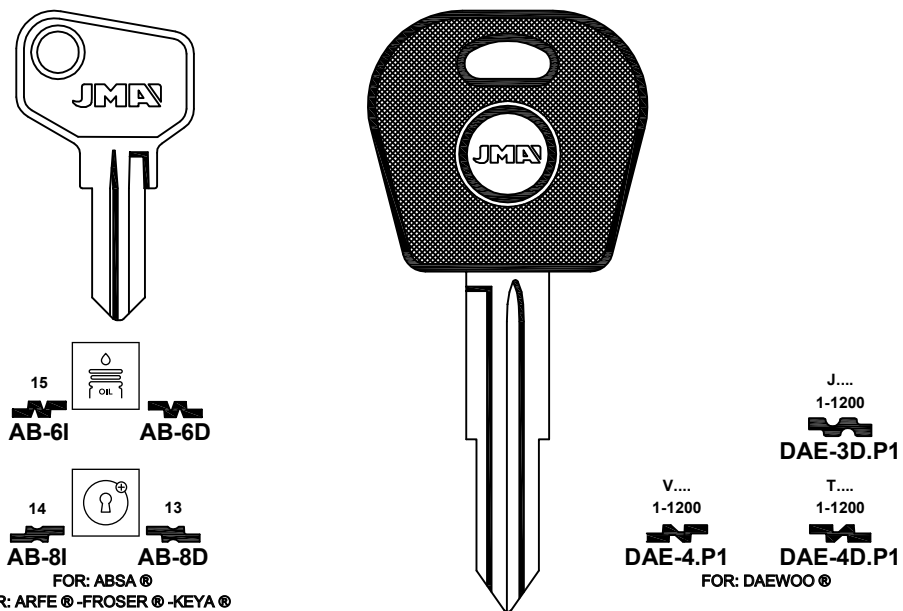

15  
**AB-6I**

15  
**AB-6D**

J...  
1-1200  
**DAE-3D.P1**

14  
**AB-8I**

13  
**AB-8D**  
FOR: ABSA®  
FOR: ARFE® -FROSER® -KEYA®

V...  
1-1200  
**DAE-4.P1**

T...  
1-1200  
**DAE-4D.P1**  
FOR: DAEWOO®

FOR: SUZUKI®

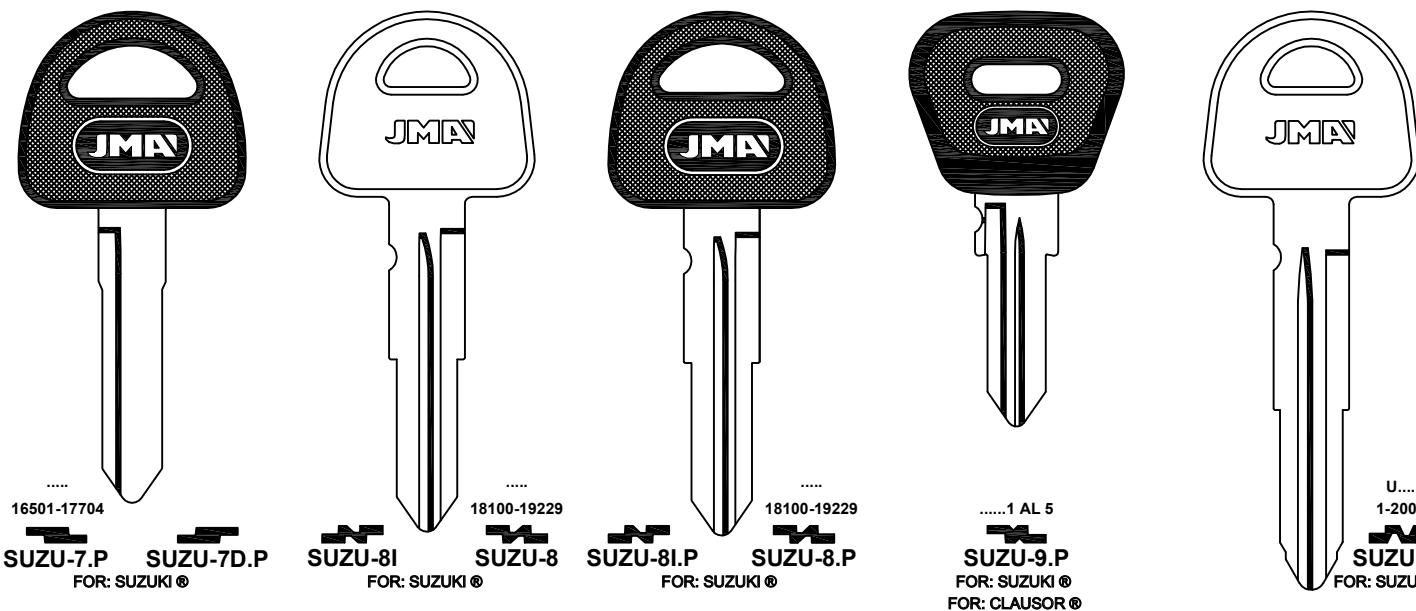

.....  
16501-17704  
**SUZU-7.P**  
FOR: SUZUKI®

.....  
16501-17704  
**SUZU-7D.P**  
FOR: SUZUKI®

.....  
18100-19229  
**SUZU-8I**  
FOR: SUZUKI®

.....  
18100-19229  
**SUZU-8**

.....  
18100-19229  
**SUZU-8I.P**  
FOR: SUZUKI®

.....  
18100-19229  
**SUZU-8.P**  
FOR: SUZUKI®

.....  
1 AL 5  
**SUZU-9.P**  
FOR: SUZUKI®  
FOR: CLAUSOR®

U...  
1-2000  
**SUZU-10**  
FOR: SUZUKI®

FOR: SUZUKI®

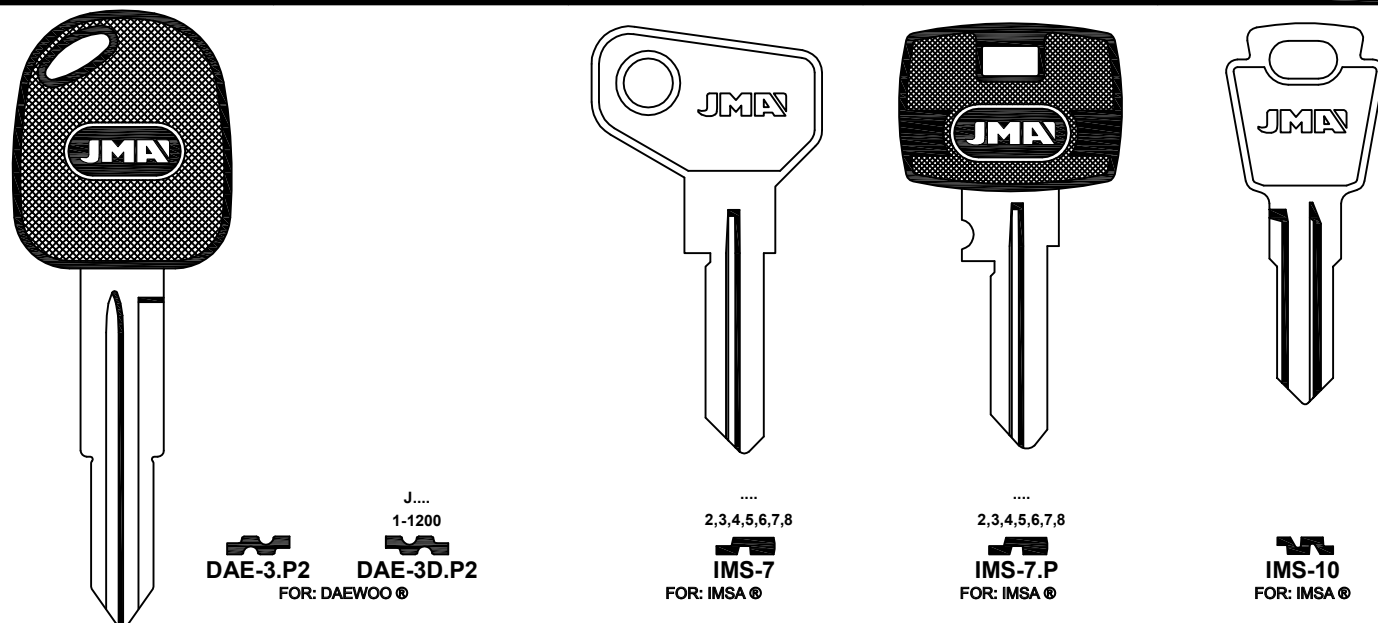

J...  
1-1200  
**DAE-3.P2**

J...  
1-1200  
**DAE-3D.P2**  
FOR: DAEWOO®

.....  
2,3,4,5,6,7,8  
**IMS-7**  
FOR: IMSA®

.....  
2,3,4,5,6,7,8  
**IMS-7.P**  
FOR: IMSA®

.....  
2,3,4,5,6,7,8  
**IMS-10**  
FOR: IMSA®

FOR: SUZUKI®

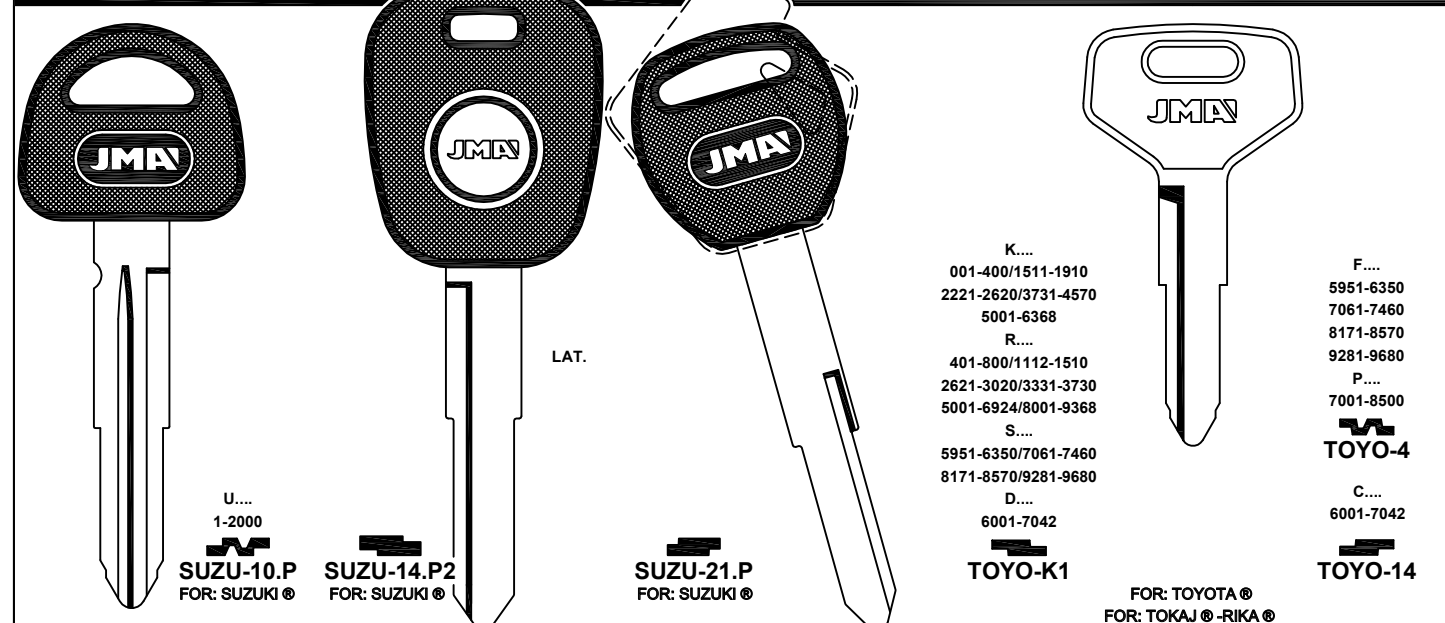

U...  
1-2000  
**SUZU-10.P**  
FOR: SUZUKI®

LAT.  
**SUZU-14.P2**  
FOR: SUZUKI®

**SUZU-21.P**  
FOR: SUZUKI®

K...  
001-400/1511-1910  
2221-2620/3731-4570  
5001-6368  
R...  
401-800/1112-1510  
2621-3020/3331-3730  
5001-6924/8001-9368  
S...  
5951-6350/7061-7460  
8171-8570/9281-9680  
D...  
6001-7042  
**TOYO-K1**

F...  
5951-6350  
7061-7460  
8171-8570  
9281-9680  
P...  
7001-8500  
**TOYO-4**

C...  
6001-7042  
**TOYO-14**

FOR: TOYOTA®  
FOR: TOKAJ® -RIKA®

Concerning the marks and commercial denominations see legal warning.  
Concerniente a las marcas y denominaciones comerciales ver aviso legal.  
Marka eta izendapen komertzialiei dagokienez, ikus lege-oharra.  
Concernant les marques et denominations commerciales voir la note dans l'index.

**JMA** Opening the future

**JMA** Opening the future

Beziehen auf die marke und handelsname sehen sie die notiz im Impressum.  
Relativamente às marcas e denominações comerciais, ver aviso legal.  
Jeśli chodzi o znaki i nazwy handlowe, patrz Informacje prawne.





FOR: SUZUKI®

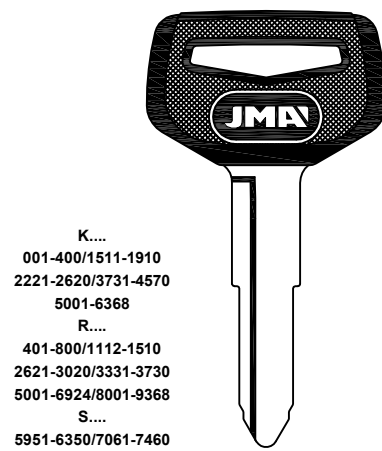

K....  
001-400/1511-1910  
2221-2620/3731-4570  
5001-6368  
R....  
401-800/1112-1510  
2621-3020/3331-3730  
5001-6924/8001-9368  
S....  
5951-6350/7061-7460  
8171-8570/9281-9680

F....  
5951-6350  
7061-7460  
8171-8570  
9281-9680  
P....  
7001-8500

TOYO-4.P

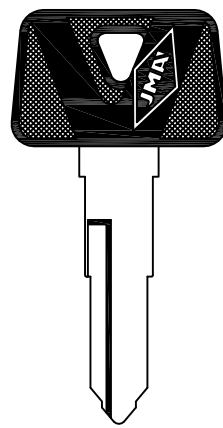

1 AL 4  
32010-79897

A....  
32010-79897  
YAMA-18I.P

B....  
32010-79897  
YAMA-18D.P

C....  
32010-79897  
YAMA-19I.P

D....  
32010-79897  
YAMA-19D.P

E....  
32010-79897  
YAMA-20I.P

F....  
32010-79897  
YAMA-20D.P

C....  
32010-79897  
YAMA-28.P

E....  
32010-79897  
YAMA-29.P

FOR: YAMAHA®

TOYO-K1.P

FOR: TOYOTA®  
FOR: TOKAJ®-RIKA®

TOYO-14.P

FOR: TALBOT SIMCA®

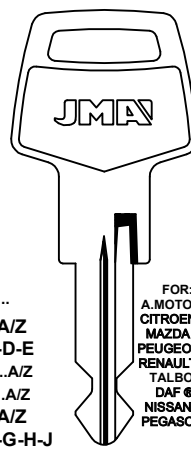

.....  
A/Z  
B-C-D-E  
1/9...A/Z  
1/9...A/Z  
1/9...A/Z  
B-D-E-G-H-J  
1/9...A/Z  
1/9...A/Z  
E-M-N-P-R  
CHR-3  
FOR: CHRYSLER®  
FOR: CLAUSSOR®-NEIMAN®

FOR: TALBOT SIMCA®

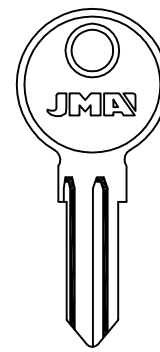

J...  
001-224  
PJ-1  
FOR: PJ®  
FOR: KIFERM®

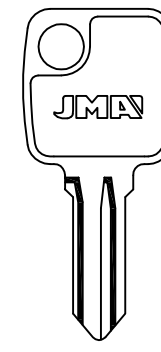

J...  
001-224  
PJ-2  
FOR: PJ®  
FOR: KIFERM®

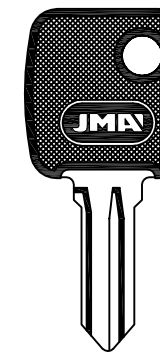

J...  
001-224  
PJ-2.P  
FOR: PJ®  
FOR: KIFERM®

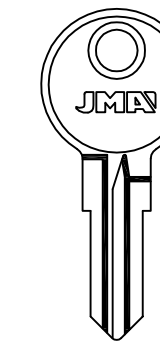

K...4-6-8  
K...4-6-8-A-B-C  
G..01-99  
PJ-3  
FOR: PJ®

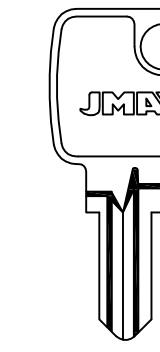

K...4-6-8  
K...4-6-8-A-B-C  
PJ-K  
FOR: PJ®

FOR: TALBOT SIMCA®

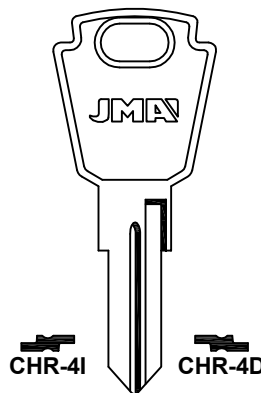

CHR-4I  
CHR-4D  
RO-1IS  
RO-1DS  
C  
001-224  
RO-3  
FOR: RONIS®

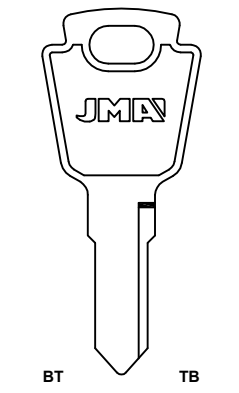

BT  
001-650  
LAS-BT  
CR  
001-650  
LAS-CR  
TB  
001-650  
LAS-TB  
RC  
001-650  
LAS-RC  
FOR: LAS®

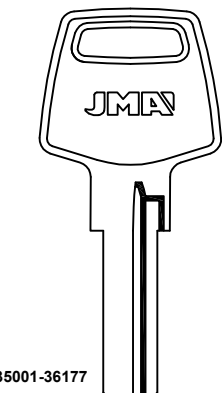

35001-36177  
LMP-3  
70001-72500  
75000-77500  
1AA-7FZ  
LMP-4  
FOR: LMP®  
FOR: GELBON®-SEIMA®

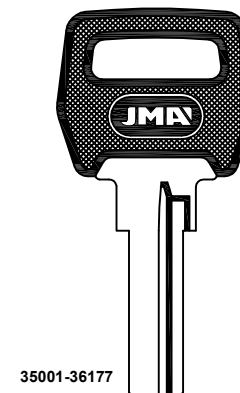

35001-36177  
LMP-3.P  
70001-72500  
75000-77500  
1AA-7FZ  
LMP-4.P  
LMP-5.P  
FOR: LMP®  
FOR: GELBON®-SEIMA®

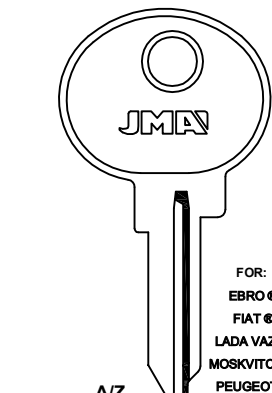

.....A/Z  
A/Z.....  
A/Z.....A/Z  
1 AL 7  
.....A/Z  
0 AL 9  
NE-3  
NE-3D  
FOR: NEIMAN®  
FOR: CLAUSSOR®

FOR:  
EBRO®  
FIAT®  
LADA VAZ®  
MOSKVITCH®  
PEUGEOT®  
RENAULT®  
TALBOT SIMCA®  
ZAZ®  
DAF®  
VOLVO®

FOR: TALBOT SIMCA®



K...4-6-8  
K...4-6-8-A-B-C  
PJ-K.P  
FOR: PJ®

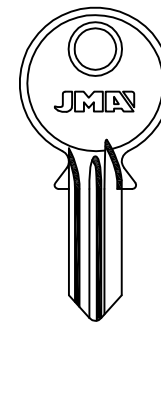

A8..AA-DS  
..8AB-ZZ  
S...385-402  
RO-1I  
FOR: ABSA®-FROSER®-PJ®-SADV®

A9..AA-DS  
..8AB-ZZ  
S...403-420  
RO-1D  
FOR: ABSA®-FROSER®-PJ®-SADV®

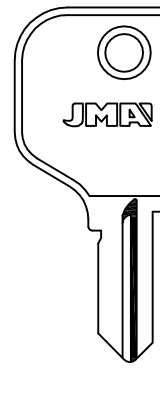

E...  
001-649  
VA-6  
FOR: VACHETTE®  
FOR: SIMPLEX®

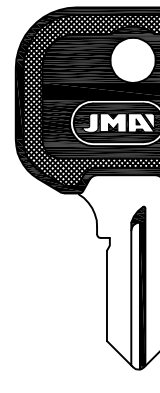

E...  
001-649  
VA-6.P  
FOR: VACHETTE®  
FOR: SIMPLEX®

FOR: TALBOT SIMCA®

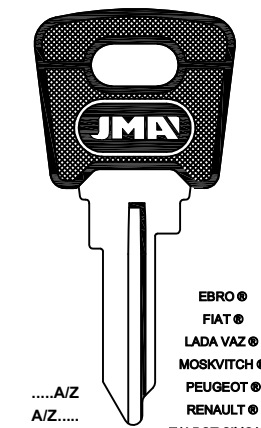

.....A/Z  
A/Z.....  
A/Z.....A/Z  
1 AL 7  
.....A/Z  
0 AL 9  
NE-3.P1  
FOR: NEIMAN®  
FOR: CLAUSSOR®

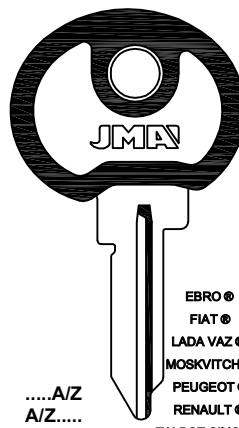

.....A/Z  
A/Z.....  
A/Z.....A/Z  
1 AL 7  
.....A/Z  
0 AL 9  
NE-3.P2  
FOR: NEIMAN®  
FOR: CLAUSSOR®

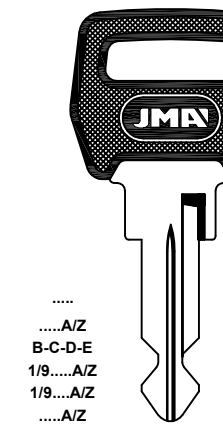

.....  
.....A/Z  
B-C-D-E  
1/9...A/Z  
1/9...A/Z  
.....A/Z  
B-D-E-G-H-J  
.1/9...A/Z  
.1/9...A/Z  
E-M-N-P-R  
NE-22.P2  
FOR: NEIMAN®  
FOR: CLAUSSOR®

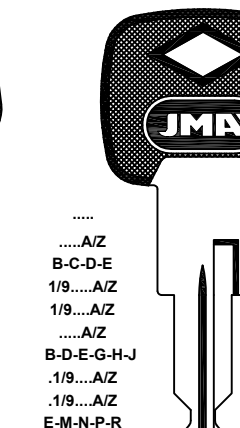

.....  
.....A/Z  
B-C-D-E  
1/9...A/Z  
1/9...A/Z  
.....A/Z  
B-D-E-G-H-J  
.1/9...A/Z  
.1/9...A/Z  
E-M-N-P-R  
NE-33.P  
FOR: NEIMAN®  
FOR: CLAUSSOR®

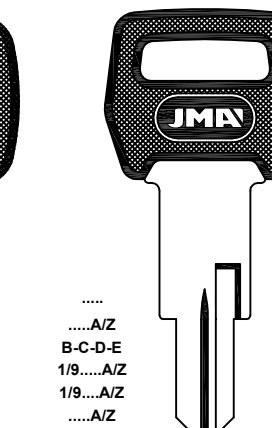

.....  
.....A/Z  
B-C-D-E  
1/9...A/Z  
1/9...A/Z  
.....A/Z  
B-D-E-G-H-J  
.1/9...A/Z  
.1/9...A/Z  
E-M-N-P-R  
NE-33.P1  
FOR: NEIMAN®  
FOR: CLAUSSOR®

FOR: TALBOT SIMCA®

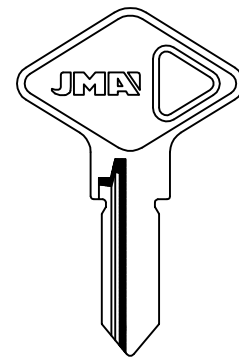

1R...000-999  
2R...1000-1837  
3R...000-665  
VA-7  
FOR: VACHETTE®

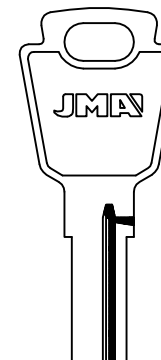

A...000-999  
B...000-999  
F...000-116  
VA-16  
FOR: VACHETTE®

FOR: TATA®

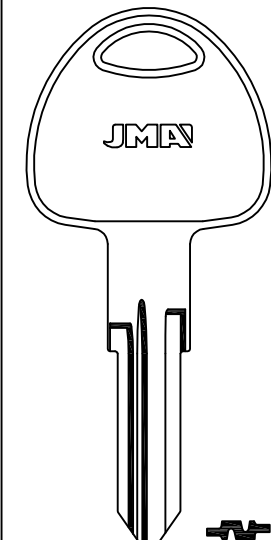

FOR: TATA®  
TAT-1D

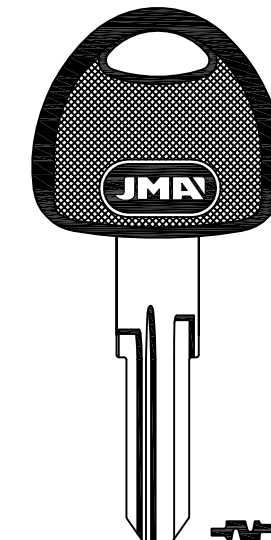

FOR: TATA®  
TAT-1D.P

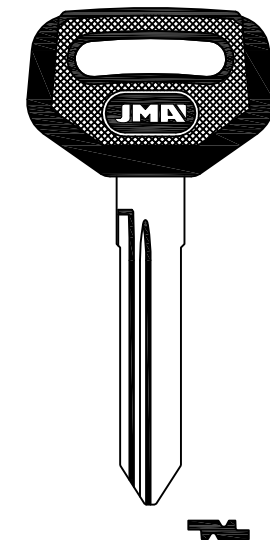

FOR: TATA®  
TAT-2D.P

Concerning the marks and commercial denominations see legal warning.  
Concieniente a las marcas y denominaciones comerciales ver aviso legal.  
Marka eta izendapen komertzialiei dagokienez, ikus lege-oharra.  
Concernant les marques et denominations commerciales voir la note dans l'index.

FOR: TOYOTA®

**MIT-2I**  
 FOR: MITSUBISHI®  
 H  
 001-400  
 2221-2620  
 4441-4640  
 4641-5143  
 E  
 2001-3000

**MIT-2D**  
 FOR: MITSUBISHI®  
 H  
 001-400  
 2221-2620  
 4441-4640  
 4641-5143  
 E  
 2001-3000

**MIT-2I.P**  
 FOR: MITSUBISHI®  
 H  
 001-400  
 2221-2620  
 4441-4640  
 4641-5143  
 E  
 2001-3000

**MIT-2D.P**  
 FOR: MITSUBISHI®  
 H  
 001-400  
 2221-2620  
 4441-4640  
 4641-5143  
 E  
 2001-3000

**TOYO-2**  
 FOR: TOYOTA®  
 FOR: TOKAJ®-RIKA®  
 A....  
 0001-0400  
 2221-2620  
 4441-4640  
 B....  
 5001-6000  
 C....  
 6001-7000  
 M....  
 5551-5950  
 6661-7060  
 7771-8170  
 8814-9280  
 N....  
 1921-2220

**TOYO-3**  
 FOR: TOYOTA®  
 FOR: TOKAJ®-RIKA®  
 ....7001-9000  
 K....7001-9000

**TOYO-3.P**  
 FOR: TOYOTA®  
 FOR: TOKAJ®-RIKA®  
 ....7001-9000  
 K....7001-9000

FOR: TOYOTA®

**TOYO-K1**  
 FOR: TOYOTA®  
 FOR: TOKAJ®-RIKA®  
 K....  
 001-400/1511-1910  
 2221-2620/3731-4570  
 5001-6368  
 R....  
 401-800/1112-1510  
 2621-3020/3331-3730  
 5001-6924/8001-9368  
 S....  
 5951-6350/7061-7460  
 8171-8570/9281-9680  
 D....  
 6001-7042

**TOYO-4**  
 FOR: TOYOTA®  
 FOR: TOKAJ®-RIKA®  
 F....  
 5951-6350  
 7061-7460  
 8171-8570  
 9281-9680  
 P....  
 7001-8500

**TOYO-K1.P**  
 FOR: TOYOTA®  
 FOR: TOKAJ®-RIKA®  
 K....  
 001-400/1511-1910  
 2221-2620/3731-4570  
 5001-6368  
 R....  
 401-800/1112-1510  
 2621-3020/3331-3730  
 5001-6924/8001-9368  
 S....  
 5951-6350/7061-7460  
 8171-8570/9281-9680  
 D....  
 6001-7042

**TOYO-4.P**  
 FOR: TOYOTA®  
 FOR: TOKAJ®-RIKA®  
 F....  
 5951-6350  
 7061-7460  
 8171-8570  
 9281-9680  
 P....  
 7001-8500

**TOYO-5**  
 FOR: TOYOTA®  
 FOR: TOKAJ®-RIKA®  
 ....7001-9000  
 K....7001-9000

FOR: TOYOTA®

**TOYO-5.P**  
 FOR: TOYOTA®  
 FOR: TOKAJ®-RIKA®  
 ....7001-9000  
 K....7001-9000

**TOYO-5.P1**  
 FOR: TOYOTA®  
 FOR: TOKAJ®-RIKA®  
 ....7001-9000  
 K....7001-9000

**TOYO-6**  
 FOR: TOYOTA®  
 FOR: TOKAJ®-RIKA®

**TOYO-8**  
 FOR: TOYOTA®  
 FOR: TOKAJ®-RIKA®  
 ....7001-9000  
 K....7001-9000

**TOYO-8I.P**  
 FOR: TOYOTA®  
 FOR: TOKAJ®-RIKA®  
 ....7001-9000  
 K....7001-9000

**TOYO-8.P**  
 FOR: TOYOTA®  
 FOR: TOKAJ®-RIKA®  
 ....7001-9000  
 K....7001-9000

FOR: TOYOTA®

**TOYO-9**  
 FOR: TOYOTA®  
 FOR: TOKAJ®-RIKA®  
 G/P/W/X....  
 1-2000

**TOYO-9.P**  
 FOR: TOYOTA®  
 FOR: TOKAJ®-RIKA®  
 G/P/W/X....  
 1-2000

**TOYO-9.P1**  
 FOR: TOYOTA®  
 FOR: TOKAJ®-RIKA®  
 G/P/W/X....  
 1-2000

**TOYO-9.P2**  
 FOR: TOYOTA®  
 FOR: TOKAJ®-RIKA®

**TOYO-11**  
 FOR: TOYOTA®  
 FOR: TOKAJ®-RIKA®  
 S....  
 0001-2878

FOR: TOYOTA®

**TOYO-10.P**  
 FOR: TOYOTA®  
 FOR: TOKAJ®-RIKA®  
 S....  
 0001-2878

**TOYO-10.P1**  
 FOR: TOYOTA®  
 FOR: TOKAJ®-RIKA®  
 S....  
 0001-2878

**TOYO-11.P**  
 FOR: TOYOTA®  
 FOR: TOKAJ®-RIKA®  
 S....  
 0001-2878

**TOYO-11.P1**  
 FOR: TOYOTA®  
 FOR: TOKAJ®-RIKA®  
 S....  
 0001-2878

**TOYO-12**  
 FOR: TOYOTA®  
 FOR: TOKAJ®-RIKA®  
 F....  
 5951-6350  
 7061-7460  
 8171-8570  
 9281-9680  
 P....  
 7001-8500

**TOYO-12D**  
 FOR: TOYOTA®  
 FOR: TOKAJ®-RIKA®  
 C....  
 6001-8042  
 U....  
 3001-4000  
 Z....  
 1-1000

**TOYO-13**  
 FOR: TOYOTA®  
 FOR: TOKAJ®-RIKA®  
 K....  
 001-400/1511-1910  
 2221-2620/3731-4570  
 5001-6368  
 R....  
 401-800/1112-1510  
 2621-3020/3331-3730  
 5001-6924/8001-9368  
 S....  
 5951-6350/7061-7460  
 8171-8570/9281-9680  
 D....  
 6001-7042

**TOYO-12D.P**  
 FOR: TOYOTA®  
 FOR: TOKAJ®-RIKA®  
 F....  
 5951-6350  
 7061-7460  
 8171-8570  
 9281-9680  
 P....  
 7001-8500

**TOYO-15**  
 FOR: TOYOTA®  
 FOR: TOKAJ®-RIKA®  
 1....  
 1-5000

**TOYO-15.P**  
 FOR: TOYOTA®  
 FOR: TOKAJ®-RIKA®  
 1....  
 1-5000

**TOYO-15D.P**  
 FOR: TOYOTA®  
 FOR: TOKAJ®-RIKA®  
 1....  
 1-5000

**TOYO-15.P10**  
 FOR: TOYOTA®  
 FOR: TOKAJ®-RIKA®  
 1....  
 1-5000

FOR: TOYOTA®

**TOYO-12.P1**  
 FOR: TOYOTA®  
 FOR: TOKAJ®-RIKA®  
 F....  
 5951-6350  
 7061-7460  
 8171-8570  
 9281-9680  
 P....  
 7001-8500

**TOYO-13.P1**  
 FOR: TOYOTA®  
 FOR: TOKAJ®-RIKA®  
 C....  
 6001-8042  
 U....  
 3001-4000  
 Z....  
 1-1000

**TOYO-15**  
 FOR: TOYOTA®  
 FOR: TOKAJ®-RIKA®  
 1....  
 1-5000

**TOYO-15.P**  
 FOR: TOYOTA®  
 FOR: TOKAJ®-RIKA®  
 1....  
 1-5000

**TOYO-15D.P**  
 FOR: TOYOTA®  
 FOR: TOKAJ®-RIKA®  
 1....  
 1-5000

**TOYO-15.P10**  
 FOR: TOYOTA®  
 FOR: TOKAJ®-RIKA®  
 1....  
 1-5000

Concerning the marks and commercial denominations see legal warning.  
 Concerniente a las marcas y denominaciones comerciales ver aviso legal.  
 Marka eta izendapen komertzialiei dagokienez, ikus lege-oharra.  
 Concernant les marques et denominations commerciales voir la note dans l'index.

FOR: TOYOTA®

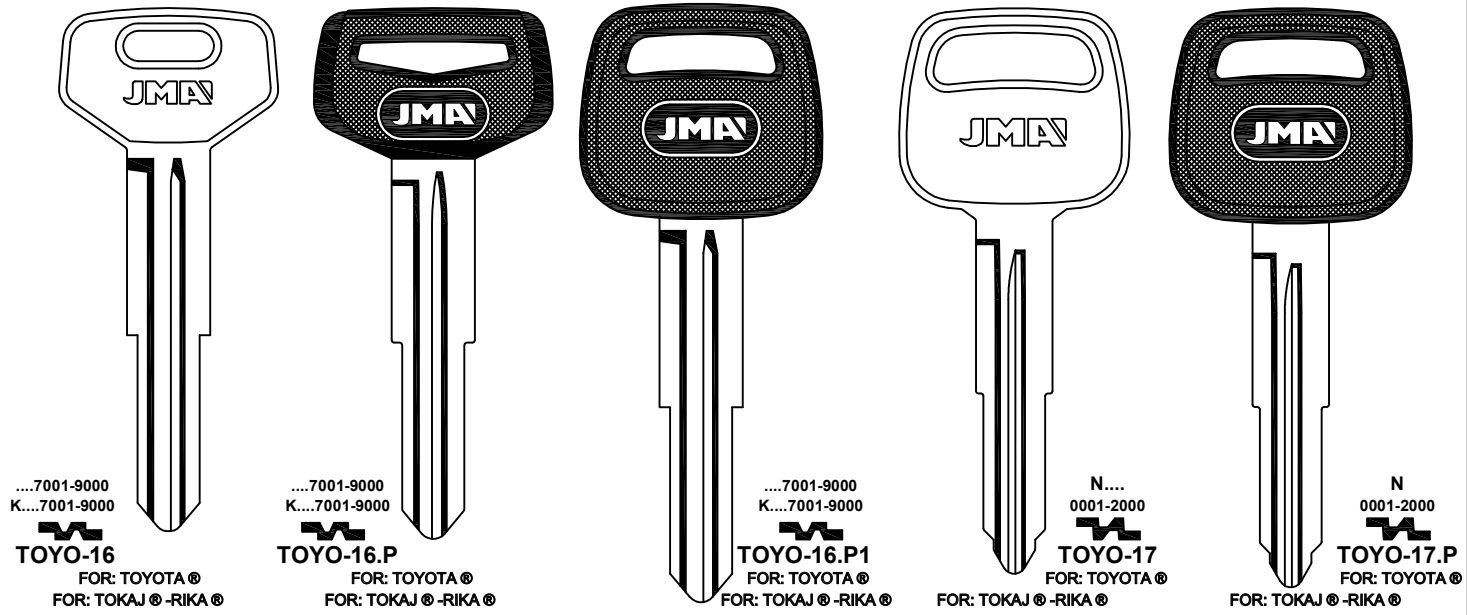

FOR: TOYOTA®

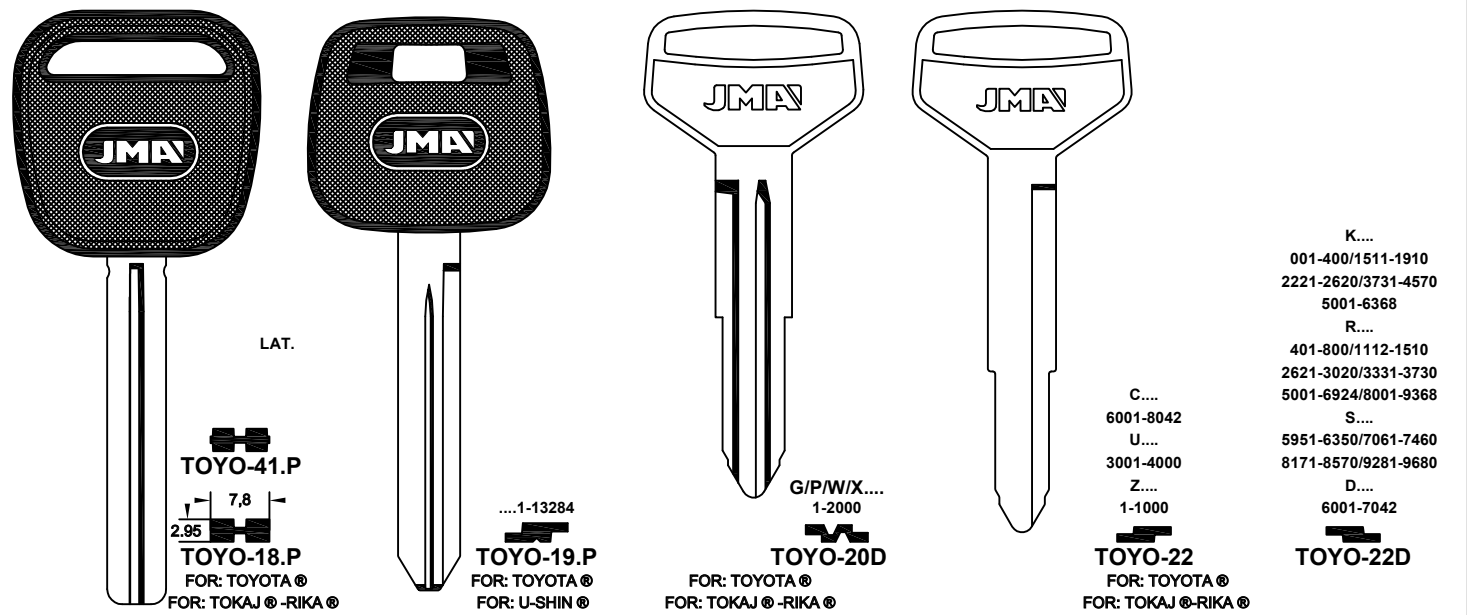

FOR: TOYOTA®

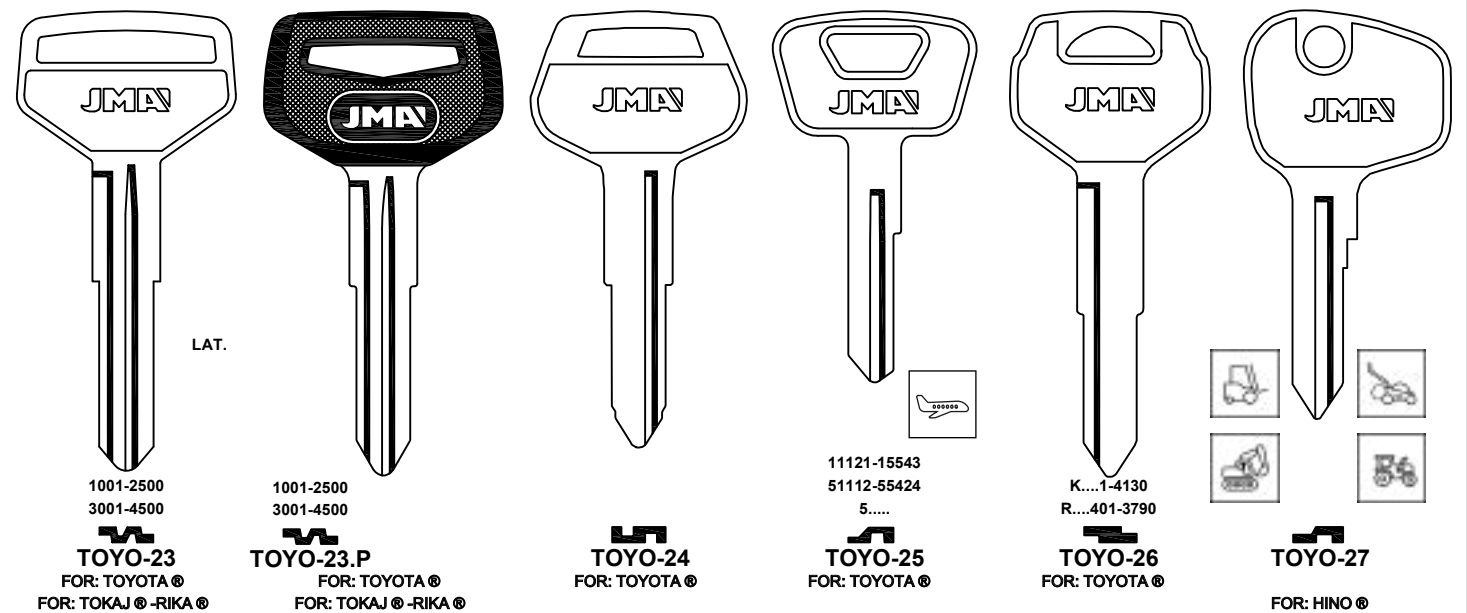

FOR: TOYOTA®

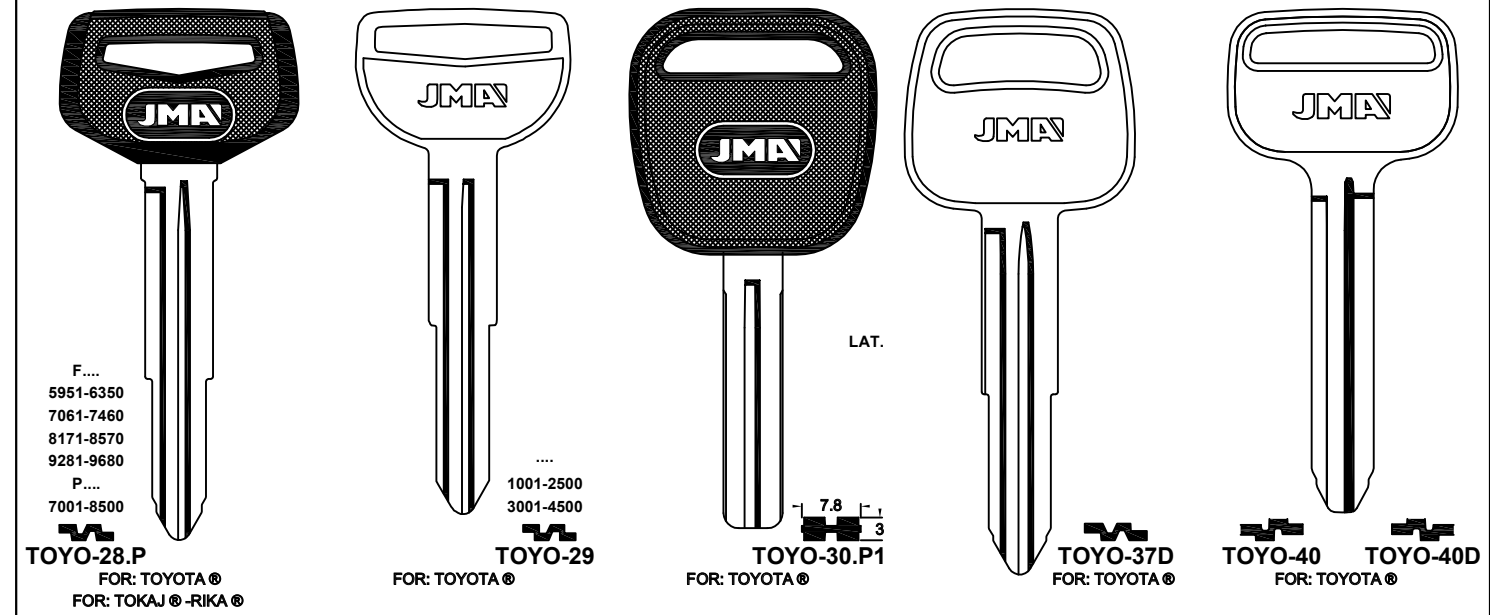

FOR: TRABANT®

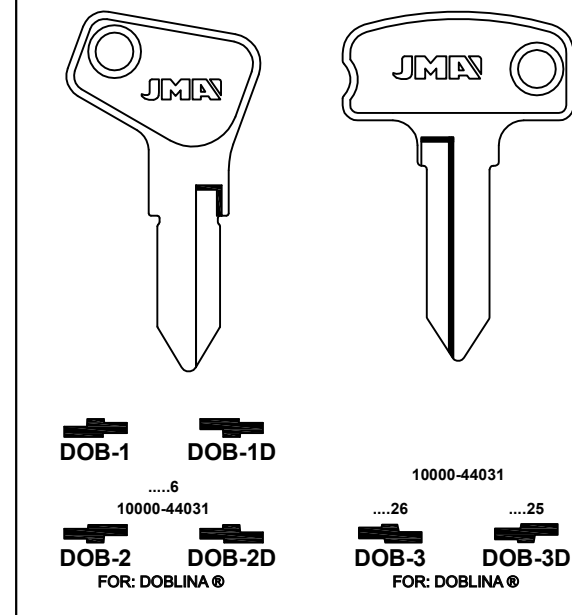

FOR: TRIUMPH®

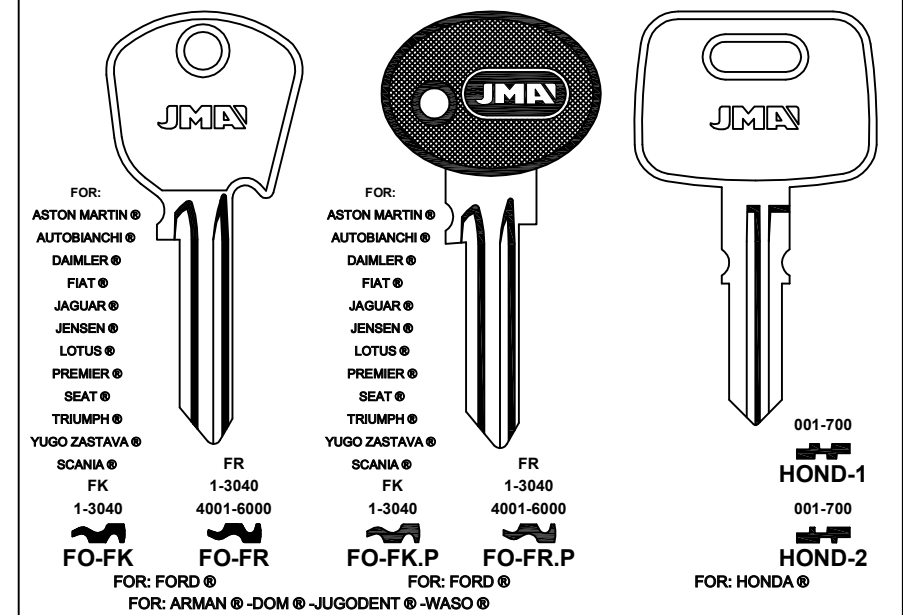

FOR: TRIUMPH®

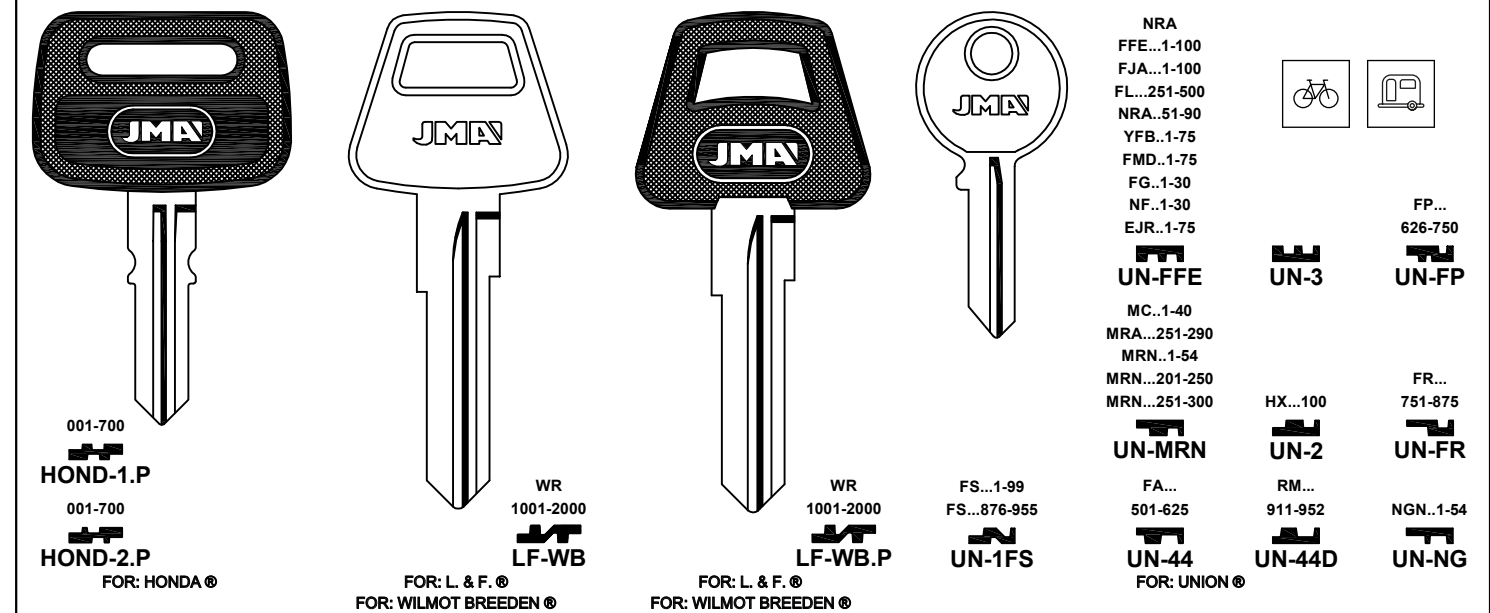

Concerning the marks and commercial denominations see legal warning.  
Concerniente a las marcas y denominaciones comerciales ver aviso legal.  
Marka eta izendapen komertzialiei dagokienez, ikus lege-oharra.  
Concernant les marques et dénominations commerciales voir la note dans l'index.

**JMA** Opening the future

**JMA** Opening the future

Beziehen auf die Marke und Handelsname sehen Sie die Notiz im Impressum.  
Relativamente às marcas e denominações comerciais, ver aviso legal.  
Jeśli chodzi o znaki i nazwy handlowe, patrz Informacje prawne.



FOR: TRIUMPH®

FOR: UAZ®

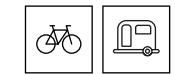
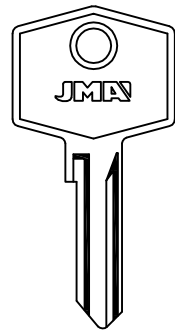

FK...  
01-99  
876-955



FOR: UNION®  
FOR: WBH®

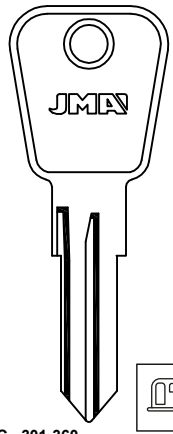

FT-BC...301-360  
BC-FT...101-225  
LF...451-575  
CB...801-875



FOR: UNION®  
FOR: CEM®

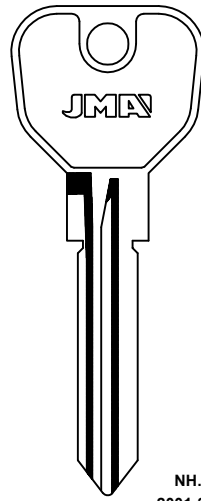

NH...  
2001-3000



FOR: UNION®  
FOR: CEM®

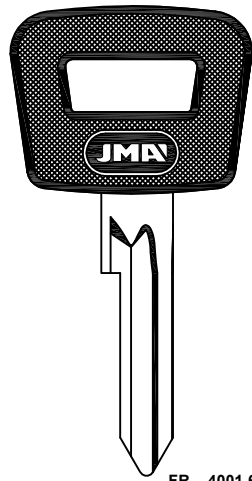

FR...4001-6000  
FZ...1-1232



FOR: WASO®  
FOR: ARMAN® -DOM®

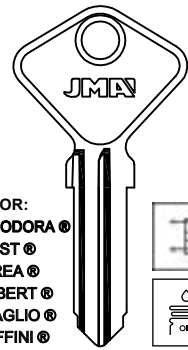

FOR:  
CROMODORA®  
FIST®  
FREA®  
GIOBERT®  
MIRAGLIO®  
RUFFINI®



6  
100-309



AF-5I

2  
100-309



AF-6I

8  
100-309



AF-5D

4  
100-309



AF-6D

FOR: SAFE®

FOR: VAUXHALL®

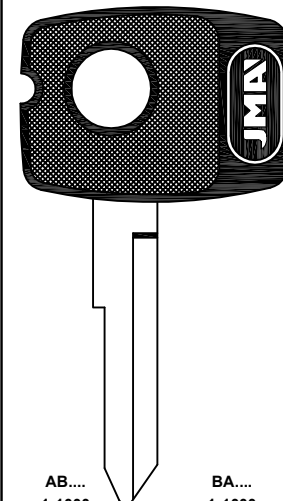

AB...  
1-1000



FOR: HUF®  
FOR: YMOS®

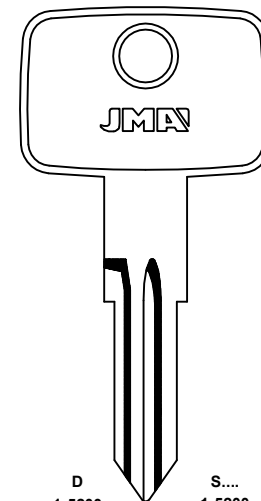

BA...  
1-1000



FOR: HUF®  
FOR: YMOS®

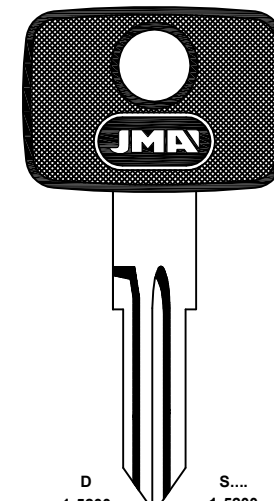

D  
1-5200



FOR: HUF®  
FOR: YMOS®

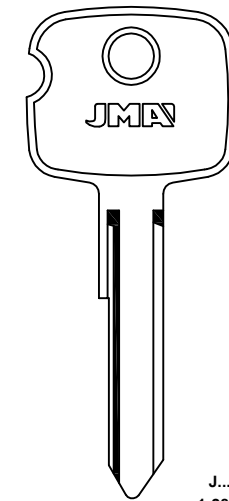

S...  
1-5200



FOR: HUF®  
FOR: YMOS®

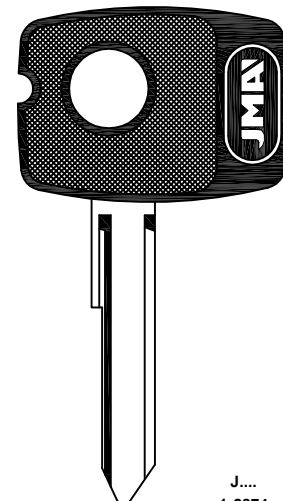

J...  
1-2874



FOR: HUF®  
FOR: YMOS®

J...  
1-2874



FOR: HUF®  
FOR: YMOS®

FOR: UAZ®

FOR: VAUXHALL®

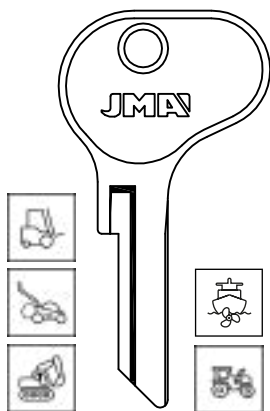

E,M,N,U,H,K  
001-100

HG,N  
140-189



BH-1  
FOR: BOSCH®  
FOR: NEIMAN®

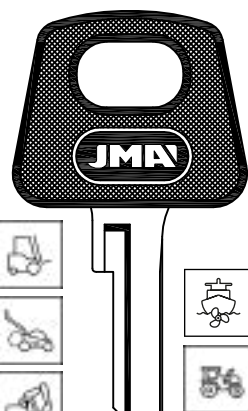

E,M,N,U,H,K  
001-100

HG,N  
140-189



BH-1.P  
FOR: BOSCH®  
FOR: NEIMAN®

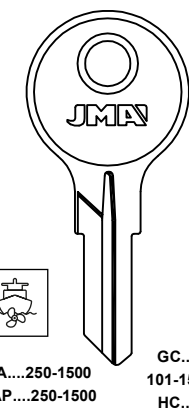

A...250-1500  
AP...250-1500  
B...250-1500  
C...1251-1700  
CB...250-1500  
DC-EP...250-699  
P...250-1500

GC...  
101-150

HC...  
0-499



BS-6

FOR: B & S®

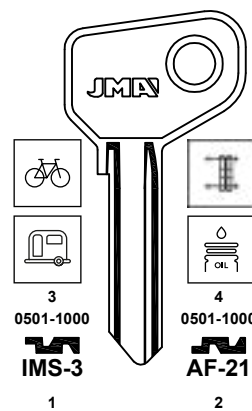

3  
0501-1000



IMS-3

1  
0501-1000



IMS-5

FOR: SAFE®

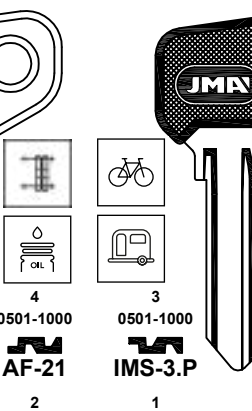

4  
0501-1000



AF-21

2  
0501-1000



AF-19

FOR: CROMODORA® -FIST® -IMSA®

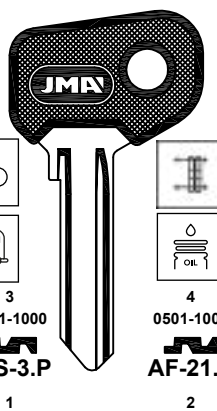

3  
0501-1000



IMS-3.P

1  
0501-1000



IMS-5.P

FOR: SAFE®

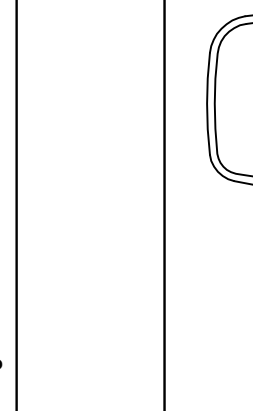

4  
0501-1000



AF-21.P

2  
0501-1000



AF-19.P

FOR: SAFE®

FOR: UAZ®

FOR: VAUXHALL®

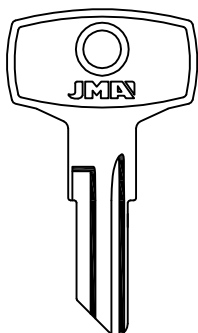

VOL-2



FOR: VOLGA®  
FOR: GAZ® -ZAZ®

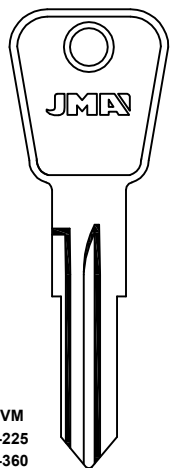

FV-VM  
101-225  
301-360  
VT...  
400-474



LF-6

FOR: L. & F.®

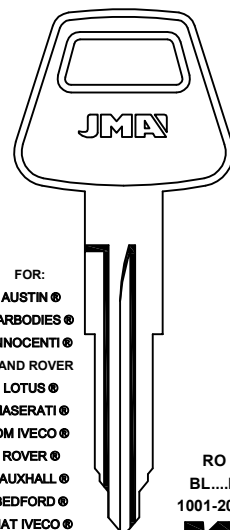

FOR:  
AUSTIN®  
CARBODIES®  
INNOCENTI®  
LAND ROVER®  
LOTUS®  
MASERATI®  
OM IVECO®  
ROVER®  
VAUXHALL®  
BEDFORD®  
FIAT IVECO®

RO  
BL...N  
1001-2000



LF-RO

FOR: L. & F.®

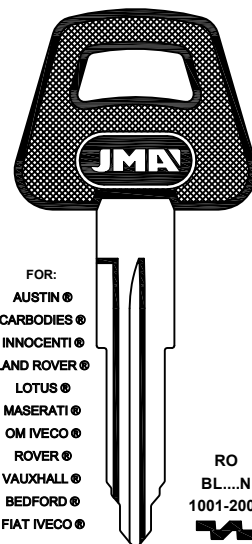

FOR:  
AUSTIN®  
CARBODIES®  
INNOCENTI®  
LAND ROVER®  
LOTUS®  
MASERATI®  
OM IVECO®  
ROVER®  
VAUXHALL®  
BEDFORD®  
FIAT IVECO®

RO  
BL...N  
1001-2000



LF-RO.P

FOR: L. & F.®

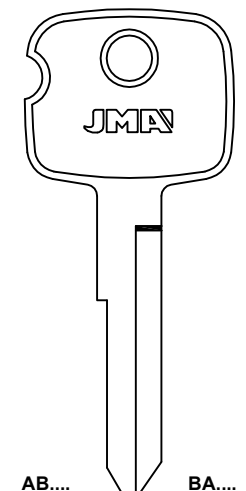

AB...  
1-1000



OP-AB

FOR: HUF®  
FOR: YMOS®



BA...  
1-1000



OP-BA

FOR: HUF®  
FOR: YMOS®

FOR: VOLGA®

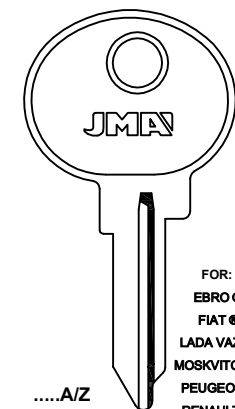

...A/Z  
A/Z...  
A/Z...A/Z

1 AL 7  
...A/Z  
0 AL 9

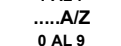

NE-3

FOR: NEIMAN®  
FOR: CLAUSOR®



...A/Z  
A/Z...  
A/Z...A/Z

1 AL 7  
...A/Z  
0 AL 9

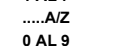

NE-3D

FOR: NEIMAN®  
FOR: CLAUSOR®

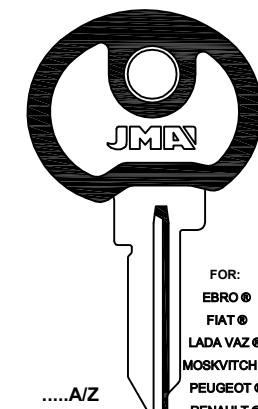

...A/Z  
A/Z...  
A/Z...A/Z

1 AL 7  
...A/Z  
0 AL 9

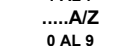

NE-3.P2

FOR: NEIMAN®  
FOR: CLAUSOR®

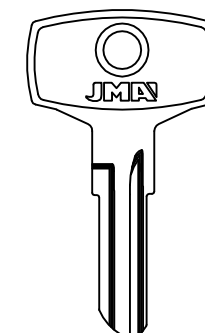

VOL-1

FOR: VOLGA®

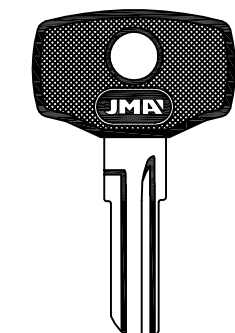

VOL-1.P

FOR: VOLGA®

Concerning the marks and commercial denominations see legal warning.  
Concerniente a las marcas y denominaciones comerciales ver aviso legal.  
Marka eta izendapen komertzialiei dagokienez, ikus lege-oharra.  
Concernant les marques et denominations commerciales voir la note dans l'index.

**JMA** Opening the future

**JMA** Opening the future

Beziehen auf die Marke und Handelsname sehen sie die Notiz im Impressum.  
Relativamente às marcas e denominações comerciais, ver aviso legal.  
Jeśli chodzi o znaki i nazwy handlowe, patrz Informacje prawne.

FOR: VOLGA®

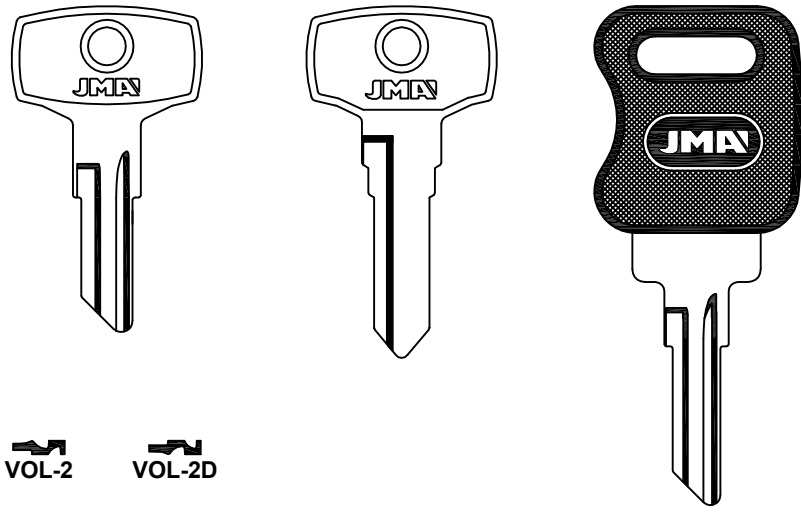

VOL-2 VOL-2D  
VOL-3 FOR: VOLGA®  
FOR: GAZ® -ZAZ®  
VOL-4 FOR: VOLGA®  
VOL-5.P FOR: VOLGA®

FOR: VOLKSWAGEN®

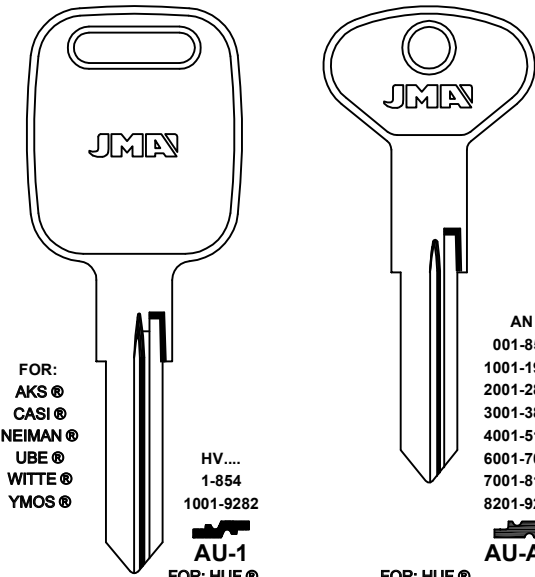

AN  
001-854  
1001-1918  
2001-2830  
3001-3890  
4001-5151  
6001-7086  
7001-8154  
8201-9282  
FOR: AKS®  
CASI®  
NEIMAN®  
UBE®  
WITTE®  
YMOS®  
HV....  
1-854  
1001-9282  
AU-1 FOR: HUF®  
AU-AN FOR: HUF®  
FOR: AKS® -CASI® -UBE® -WITTE®

FOR: VOLKSWAGEN®

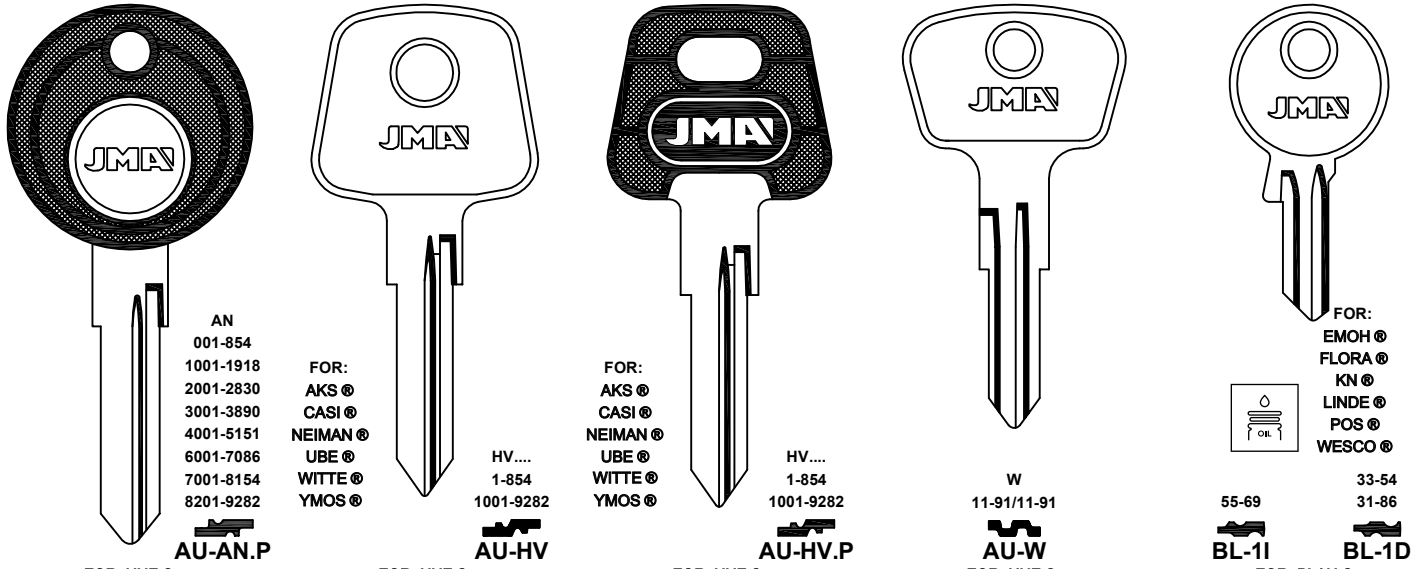

AN  
001-854  
1001-1918  
2001-2830  
3001-3890  
4001-5151  
6001-7086  
7001-8154  
8201-9282  
FOR: HUF®  
FOR: AKS® -CASI® -UBE® -WITTE®  
FOR: AKS®  
CASI®  
NEIMAN®  
UBE®  
WITTE®  
YMOS®  
HV....  
1-854  
1001-9282  
AU-AN.P FOR: HUF®  
AU-HV FOR: HUF®  
AU-HV.P FOR: HUF®  
W  
11-91/11-91  
AU-W FOR: HUF®  
FOR: AKS® -WITTE®  
33-54  
31-86  
55-69  
BL-1 FOR: BLAU®  
BL-1D FOR: BLAU®  
FOR: EMOH®  
FLORA®  
KN®  
LINDE®  
POS®  
WESCO®

FOR: VOLKSWAGEN®

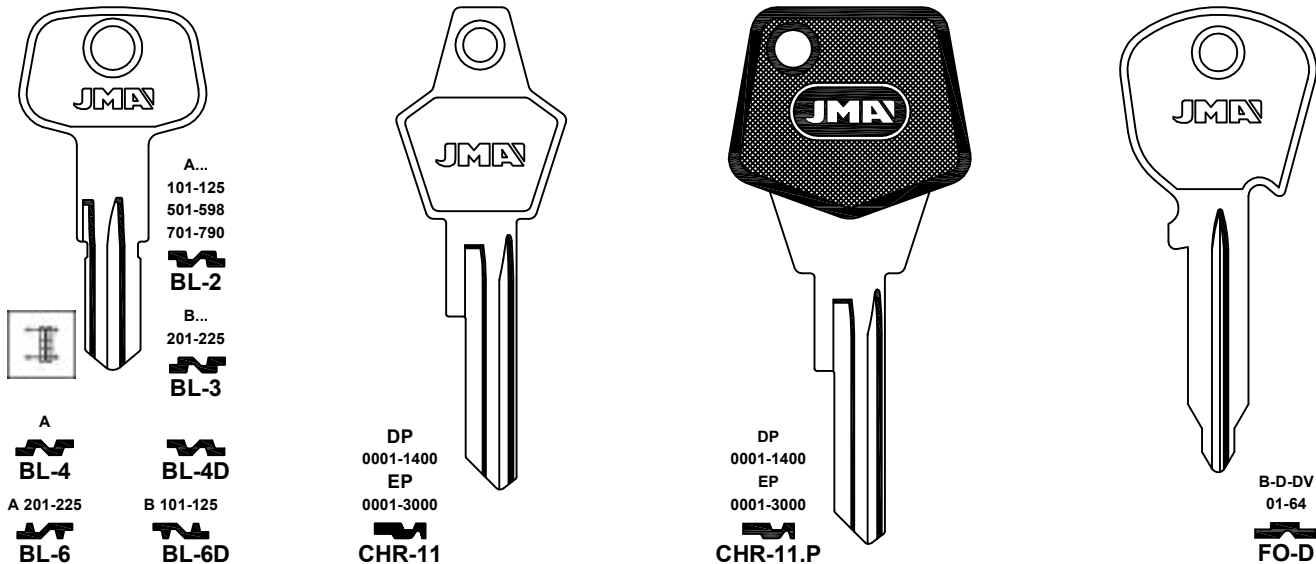

A...  
101-125  
501-598  
701-790  
BL-2  
B...  
201-225  
BL-3  
A  
BL-4  
A 201-225 B 101-125  
BL-6 BL-6D  
FOR: BLAU®  
FOR: FORT® -HK® -WASO®  
DP  
0001-1400  
EP  
0001-3000  
CHR-11 FOR: CHRYSLER®  
FOR: YALE®  
DP  
0001-1400  
EP  
0001-3000  
CHR-11.P FOR: CHRYSLER®  
FOR: YALE®  
B-D-DV  
01-64  
FO-D FOR: FORD®  
FOR: BRITAX® -KOLB®

FOR: FERRARI®

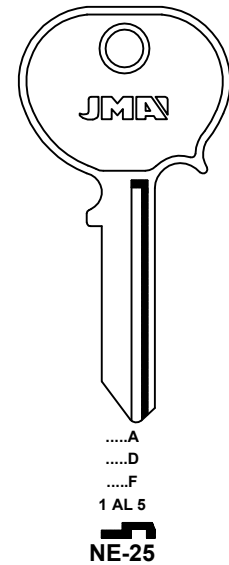

.....A  
.....D  
.....F  
1 AL 5  
NE-25 FOR: NEIMAN®

FOR: FIAT®

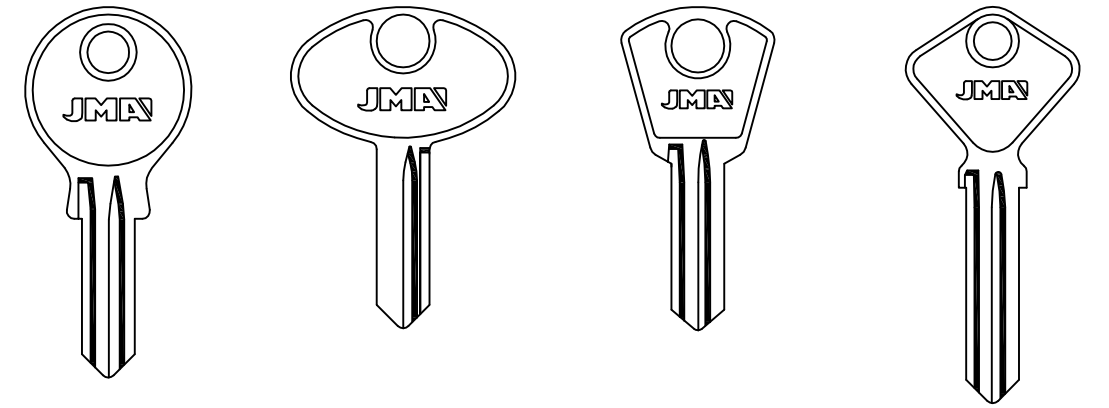

A  
001-125  
AF-1I FOR: SAFE®  
FOR: SIPEA® -MAGNETI MARELLI®  
B  
001-125  
AF-1D FOR: SAFE®  
FOR: SIPEA® -MAGNETI MARELLI®  
D  
1-125  
AF-2I FOR: SAFE®  
FOR: SIPEA® -MAGNETI MARELLI®  
C  
1-125  
AF-2D FOR: SAFE®  
FOR: SIPEA® -MAGNETI MARELLI®  
S  
615-699  
712-799  
812-899  
AF-4I FOR: SAFE®  
FOR: FIST® -TRAMA®  
D  
115-199  
212-299  
312-399  
AF-4D FOR: SAFE®  
FOR: FIST® -TRAMA®

FOR: FIAT®

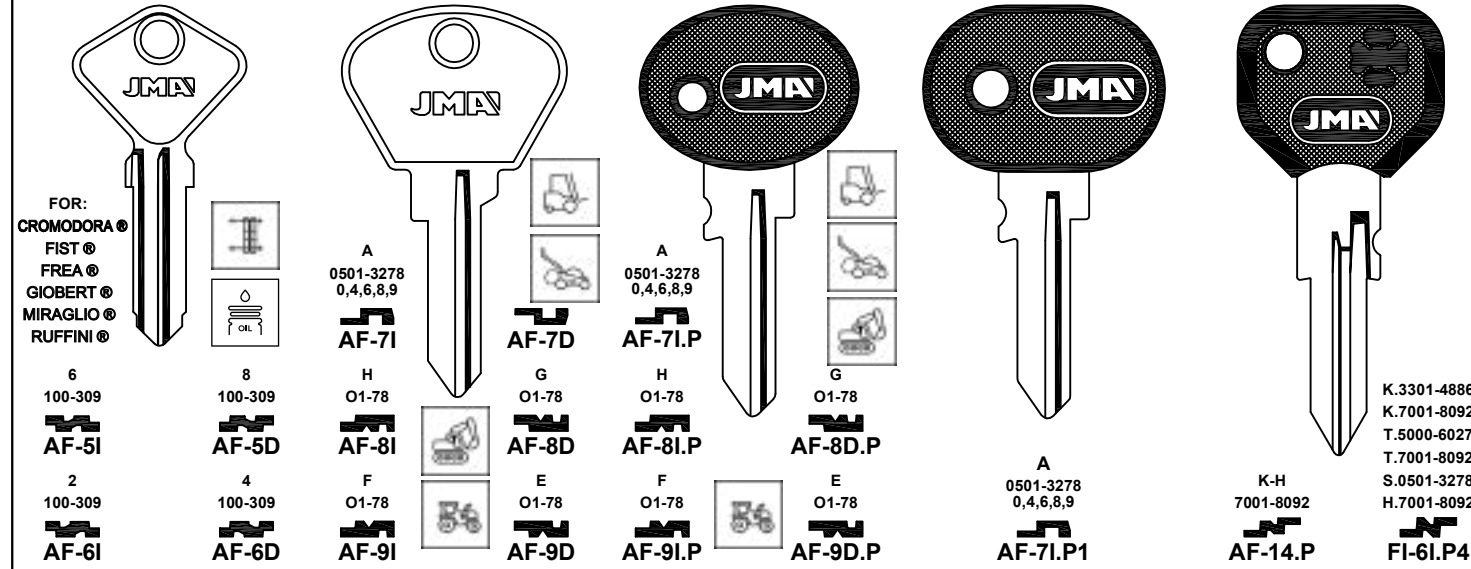

FOR: CROMODORA®  
FIST®  
FREA®  
GIOBERT®  
MIRAGLIO®  
RUFFINI®  
A  
0501-3278  
0,4,6,8,9  
AF-7I FOR: SAFE®  
AF-7D FOR: SAFE®  
AF-7I.P FOR: SIPEA®  
FOR: SAFE®  
AF-7D.P FOR: SIPEA®  
FOR: SAFE®  
H  
01-78  
AF-8I FOR: SIPEA®  
FOR: SAFE®  
G  
01-78  
AF-8D FOR: SIPEA®  
FOR: SAFE®  
AF-8I.P FOR: SIPEA®  
FOR: SAFE®  
AF-8D.P FOR: SIPEA®  
FOR: SAFE®  
A  
0501-3278  
0,4,6,8,9  
AF-7I.P1 FOR: SIPEA®  
FOR: NEIMAN®  
K-H  
7001-8092  
AF-14.P FOR: GIOBERT®  
FOR: FIST® -M.MARELLI® -NEIMAN® -SIPEA®  
K.3301-4886  
K.7001-8092  
T.5000-6027  
T.7001-8092  
S.0501-3278  
H.7001-8092  
FOR: GIOBERT®  
FOR: GIOBERT®

FOR: FIAT®

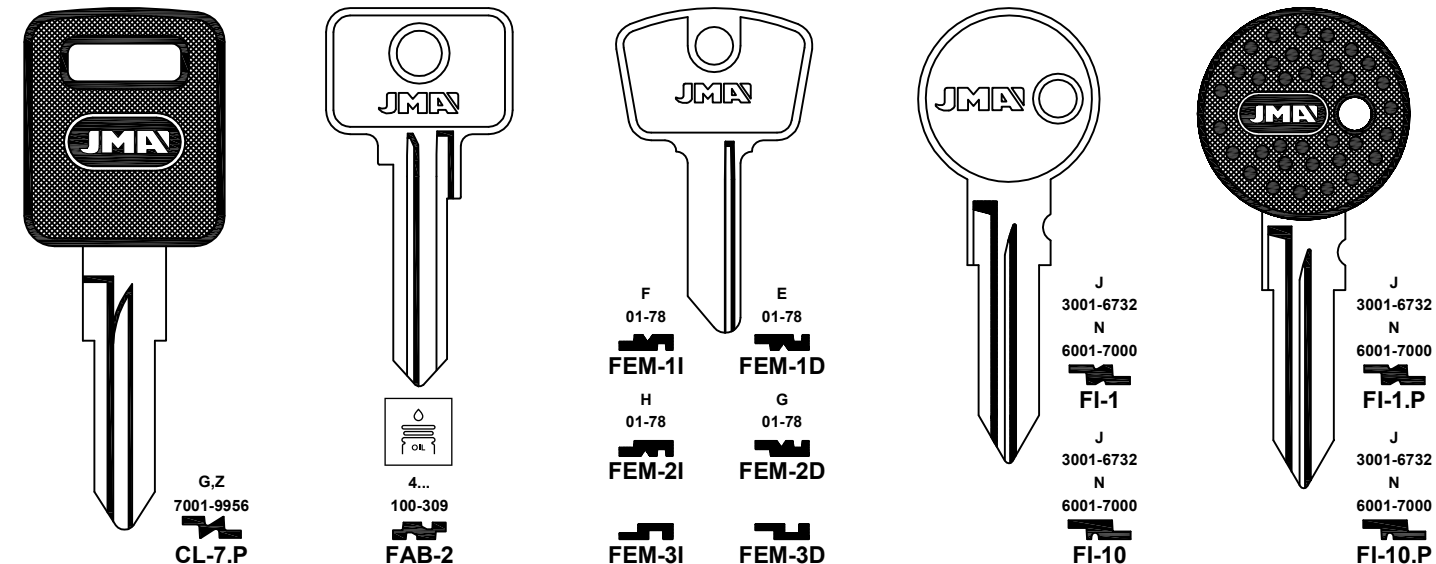

G,Z  
7001-9956  
CL-7.P FOR: CLAUSOR®  
FOR: GIOBERT®  
4...  
100-309  
FAB-2 FOR: FAAB®  
F  
01-78  
FEM-1I FOR: FEMSA®  
H  
01-78  
FEM-2I FOR: FEMSA®  
E  
01-78  
FEM-1D FOR: FEMSA®  
G  
01-78  
FEM-2D FOR: FEMSA®  
F  
01-78  
FEM-3I FOR: FEMSA®  
G  
01-78  
FEM-3D FOR: FEMSA®  
J  
3001-6732  
N  
6001-7000  
FI-1 FOR: GIOBERT®  
FOR: GIOBERT®  
J  
3001-6732  
N  
6001-7000  
FI-1.P FOR: GIOBERT®  
FOR: GIOBERT®  
J  
3001-6732  
N  
6001-7000  
FI-10.P FOR: GIOBERT®  
FOR: GIOBERT®

Concerning the marks and commercial denominations see legal warning.  
Concerniente a las marcas y denominaciones comerciales ver aviso legal.  
Marka eta izendapen komertzialiei dagokienez, ikus lege-oharra.  
Concernant les marques et denominations commerciales voir la note dans l'index.

**JMA** Opening the future

**JMA** Opening the future

Beziehen auf die Marke und Handelsname sehen sie die Notiz im Impressum.  
Relativamente às marcas e denominações comerciais, ver aviso legal.  
Jeśli chodzi o znaki i nazwy handlowe, patrz Informacje prawne.



FOR: FIAT®

**Z-GR**  
 7001-9956  
**FI-2D**  
 G  
 2001-4530  
 G-Z  
 7001-9956  
**FI-3D**  
 G  
 7001-9956  
**FI-12**  
 FOR: GIOBERT®

**Z-GR**  
 7001-9956  
**FI-2D.P3**  
 G  
 2001-4530  
 G-Z  
 7001-9956  
**FI-3D.P3**  
 G  
 7001-9956  
**FI-12.P3**  
 FOR: GIOBERT®

FOR: ALFA ROMEO®  
 CITROEN®  
 FIAT®  
 INNOCENTI®  
 LANCIA®  
 SEAT®  
 YUGO ZASTAVA®

**G**  
 2001-4530  
 G-Z  
 7001-9956  
**FI-3D.P**  
 G  
 7001-9956  
**FI-12.P**  
 FOR: GIOBERT®

FOR: ALFA ROMEO®  
 FIAT IVECO®

**G**  
 2001-4530  
 G-Z  
 7001-9956  
**FI-3D.P1**  
 G  
 7001-9956  
**FI-12.P1**  
 FOR: GIOBERT®

**G**  
 2001-4530  
 G-Z  
 7001-9956  
**FI-3D.P2**  
 FOR: GIOBERT®

FOR: FIAT®

**G**  
 2001-4530  
 G-Z  
 7001-9956  
**FI-3D.P4**  
 FOR: GIOBERT®

**G**  
 2001-4530  
 G-Z  
 7001-9956  
**FI-3D.P5**  
 FOR: GIOBERT®

FOR: ALFA ROMEO®  
 AUTOBIANCHI®  
 CITROEN®  
 FERRARI®  
 FIAT®  
 INNOCENTI®  
 LANCIA®  
 PEUGEOT®  
 YUGO ZASTAVA®  
 CAGIVA®  
 DUCATI®  
 FANTIC MOTOR®  
 GARELLI®  
 GILERA®

**K 3301-4886**  
**K 7001-8092**  
**T 5000-6027**  
**T 7001-8092**  
**S 0501-3278**  
**H 7001-8092**  
**FI-6I**  
 FOR: GIOBERT®

**K 3301-4886**  
**K 7001-8092**  
**T 5000-6027**  
**T 7001-8092**  
**S 0501-3278**  
**H 7001-8092**  
**FI-6I.P**  
 FOR: GIOBERT®

FOR: FERRARI®  
 FIAT®  
 INNOCENTI®  
 LANCIA®

**K 3301-4886**  
**K 7001-8092**  
**T 5000-6027**  
**T 7001-8092**  
**S 0501-3278**  
**H 7001-8092**  
**FI-6I.P2**  
 FOR: GIOBERT®

FOR: FERRARI®  
 FIAT®  
 CAGIVA®

FOR: FIAT®

**X**  
 3301-4886  
**FI-7I**  
 FOR: GIOBERT®  
 FOR: NEIMAN®-SIPA®

**Y**  
 7001-9956  
**FI-8I**  
 FOR: GIOBERT®  
 FOR: ARMAN®

**Y**  
 7001-9956  
**FI-8I.P**  
 FOR: GIOBERT®  
 FOR: ARMAN®

**Y**  
 7001-9956  
**FI-8I.P1**  
 FOR: GIOBERT®  
 FOR: ARMAN®

**M**  
 0001-1050  
**FI-9I**  
 FOR: GIOBERT®

FOR: FIAT®

**M**  
 0001-1050  
**FI-9I.P**  
 FOR: GIOBERT®

**N 6001-7000**  
**J 3001-6732**  
**V 0001-3051**  
**V 5001-8058**  
**AB 6001-6891**  
**FI-11**  
 FOR: GIOBERT®

**N 6001-7000**  
**J 3001-6732**  
**V 0001-3051**  
**V 5001-8058**  
**AB 6001-6891**  
**FI-11.P**  
 FOR: GIOBERT®

**W**  
 0001-9640  
**FI-13**  
 FOR: GIOBERT®

**W**  
 0001-9640  
**FI-13.P**  
 FOR: GIOBERT®

FOR: RAYTON FISSORE®-STEYR PUCH®-APRILIA®  
 FOR: RAYTON FISSORE®-STEYR PUCH®-APRILIA®  
 FOR: ALFA ROMEO®-FIAT®-LANCIA®  
 FOR: ALFA ROMEO®-FIAT®-LANCIA®

FOR: FIAT®

**W**  
 0001-9640  
**FI-13.P1**  
 FOR: GIOBERT®

**W**  
 0001-9640  
**FI-14.P**  
 FOR: GIOBERT®

**FI-15**  
 FOR: GIOBERT®

**FIA-2**  
 FOR: FIAT®

**FR**  
 1-3040  
**FO-FK**  
 FOR: ARMAN®-DOM®-JUGODENT®-WASO®

**FR**  
 1-3040  
**FO-FR**  
 FOR: FORD®

FOR: ASTON MARTIN®  
 AUTOBIANCHI®  
 DAIMLER®  
 FIAT®  
 JAGUAR®  
 JENSEN®  
 LOTUS®  
 PREMIER®  
 SEAT®  
 TRIUMPH®  
 YUGO ZASTAVA®  
 SCANIA®  
 FK  
 1-3040  
**FO-FK**  
 FOR: ARMAN®-DOM®-JUGODENT®-WASO®

FOR: FIAT®

FOR: ASTON MARTIN®  
 AUTOBIANCHI®  
 DAIMLER®  
 FIAT®  
 JAGUAR®  
 JENSEN®  
 LOTUS®  
 PREMIER®  
 SEAT®  
 TRIUMPH®  
 YUGO ZASTAVA®  
 SCANIA®  
 FK  
 1-3040  
**FO-FK.P**  
 FOR: FORD®

**FR**  
 1-3040  
**FO-FR.P**  
 FOR: FORD®

**3**  
 0501-1000  
**IMS-3**  
 FOR: SAFE®

**4**  
 0501-1000  
**AF-21**  
 FOR: SAFE®

**3**  
 0501-1000  
**IMS-3.P**  
 FOR: SAFE®

**4**  
 0501-1000  
**AF-21.P**  
 FOR: SAFE®

**1**  
 0501-1000  
**IMS-5**  
 FOR: SAFE®

**2**  
 0501-1000  
**AF-19**  
 FOR: SAFE®

**1**  
 0501-1000  
**IMS-5.P**  
 FOR: SAFE®

**2**  
 0501-1000  
**AF-19.P**  
 FOR: SAFE®

**IMS-13**  
 FOR: SAFE®

**IMS-13.P**  
 FOR: SAFE®

**1**  
 0501-1000  
**IMS-12**  
 FOR: IMSA®

**.....A/Z**  
**A/Z.....**  
**A/Z.....A/Z**  
**1 AL 7**  
**.....A/Z**  
**0 AL 9**  
**NE-3**  
 FOR: NEIMAN®

**FOR: CLAUSSOR®**

Concerning the marks and commercial denominations see legal warning.  
 Concerniente a las marcas y denominaciones comerciales ver aviso legal.  
 Marka eta izendapen komertzialiei dagokienez, ikus lege-oharra.  
 Concernant les marques et denominations commerciales voir la note dans l'index.



FOR: FIAT ®

FOR: EBRO ®  
FIAT ®  
LADA VAZ ®  
MOSKVITCH ®  
PEUGEOT ®  
RENAULT ®  
TALBOT SIMCA ®  
ZAZ ®  
DAF ®  
VOLVO ®

.....A/Z  
A/Z.....  
A/Z.....A/Z  
1 AL 7  
.....A/Z  
0 AL 9

NE-3.P  
FOR: NEIMAN ®  
FOR: CLAUSOR ®

FOR: EBRO ®  
FIAT ®  
LADA VAZ ®  
MOSKVITCH ®  
PEUGEOT ®  
RENAULT ®  
TALBOT SIMCA ®  
ZAZ ®  
DAF ®  
VOLVO ®

.....A/Z  
A/Z.....  
A/Z.....A/Z  
1 AL 7  
.....A/Z  
0 AL 9

NE-3.P2  
FOR: NEIMAN ®  
FOR: CLAUSOR ®

FOR: EBRO ®  
FIAT ®  
LADA VAZ ®  
MOSKVITCH ®  
PEUGEOT ®  
RENAULT ®  
TALBOT SIMCA ®  
ZAZ ®  
DAF ®  
VOLVO ®

NE-47  
FOR: NEIMAN (RA) ®

SI-3  
SI-3D  
SI-2D  
FOR: SISPA ®  
FOR: AUTOBLOCK ®

.....4-6-8-9  
SIP-2  
FOR: SIPEA ®  
FOR: MAGNETI MARELLI ® - NEIMAN ®

FOR: VOLKSWAGEN (BRASIL) ®

J...  
001-224  
PJ-2.P  
FOR: PJ ®  
FOR: KIFERM ®

AH....  
1-8154  
1001-9282  
VO-2  
FOR: HUF ®  
FOR: AKS ® -CASI ® -UBE ® -WITTE ®

HV....  
1-8154  
1001-9282  
VO-HV.P1  
2FF  
VO-8.P  
AH....  
1-8154  
1001-9282  
VO-2.P  
FOR: HUF ®  
FOR: AKS ® -CASI ® -UBE ® -WITTE ®

VO-2D.P  
FOR: HUF ®

FOR: FIAT ®

FOR: FIAT (ARGENTINA) ®

B....01-3278  
B....0-4-6-8-9  
SIP-3  
FOR: SIPEA ®  
FOR: ARTEB ® -CLAUSOR ® -NEIMAN ®

0111111  
FOR: AL ®  
628888  
SIX-3.P1  
FOR: SIMPLEX ®

FOR: CROMODORA ®  
FIST ®  
FREA ®  
GIOBERT ®  
MIRAGLIO ®  
RUFFINI ®

6  
100-309  
AF-5I

8  
100-309  
AF-5D

2  
100-309  
AF-6I

A  
0501-3278  
0,4,6,8,9  
AF-7I

G  
01-78  
AF-7D

4  
100-309  
AF-6D

H  
01-78  
AF-8I

G  
01-78  
AF-8D

F  
01-78  
AF-9I

E  
01-78  
AF-9D

A  
0501-3278  
0,4,6,8,9  
AF-7I.P

H  
01-78  
AF-8I.P

F  
01-78  
AF-9I.P

G  
01-78  
AF-8D.P

E  
01-78  
AF-9D.P

FOR: SIPEA ®  
FOR: SAFE ®

FOR: SIPEA ®  
FOR: SAFE ®

FOR: SIPEA ®  
FOR: SAFE ®

FOR: VOLKSWAGEN (BRASIL) ®

FOR: VOLKSWAGEN (CH) ®

AH....  
1-8154  
1001-9282  
VO-AH

HV....  
1-8154  
1001-9282  
VO-HV

VB-NV-MD....  
1-8154  
1001-9282  
VO-VB

N....  
VO-N

FOR: HUF ®  
FOR: AKS ® -CASI ® -UBE ® -WITTE ®

AH....  
1-8154  
1001-9282  
VO-AH.P

HV....  
1-8154  
1001-9282  
VO-HV.P

VB-NV-MD....  
1-8154  
1001-9282  
VO-VB.P

N....  
VO-N.P

FOR: HUF ®  
FOR: AKS ® -CASI ® -UBE ® -WITTE ®

AN....  
001-854  
1001-1918  
2001-2830  
3001-3890  
4001-5151  
6001-7086  
7001-8154  
8201-9282  
AU-AN

AN....  
001-854  
1001-1918  
2001-2830  
3001-3890  
4001-5151  
6001-7086  
7001-8154  
8201-9282  
AU-AN.P

FOR: HUF ®  
FOR: AKS ® -CASI ® -UBE ® -WITTE ®

FOR: AKS ®  
CASI ®  
NEIMAN ®  
UBE ®  
WITTE ®  
YMOS ®

HV....  
1-854  
1001-9282  
AU-1  
FOR: HUF ®

FOR: FIAT (ARGETINA) ®

FOR: VOLKSWAGEN (CHINA) ®

J  
3001-6732  
N  
6001-7000  
FI-1

J  
3001-6732  
N  
6001-7000  
FI-1.P

J  
3001-6732  
N  
6001-7000  
FI-10

FOR: GIOBERT ®

FOR: GIOBERT ®

FOR: GIOBERT ®

Y  
7001-9956  
FI-8I

FOR: GIOBERT ®  
FOR: ARMAN ®

Y  
7001-9956  
FI-8I.P

FOR: GIOBERT ®  
FOR: ARMAN ®

M  
0001-1050  
FI-9I

FOR: GIOBERT ®

AN  
001-854  
1001-1918  
2001-2830  
3001-3890  
4001-5151  
6001-7086  
7001-8154  
8201-9282  
AU-AN

FOR: HUF ®  
FOR: AKS ® -CASI ® -UBE ® -WITTE ®

AN  
001-854  
1001-1918  
2001-2830  
3001-3890  
4001-5151  
6001-7086  
7001-8154  
8201-9282  
AU-AN.P

FOR: HUF ®  
FOR: AKS ® -CASI ® -UBE ® -WITTE ®

FOR: AKS ®  
CASI ®  
NEIMAN ®  
UBE ®  
WITTE ®  
YMOS ®

HV....  
1-854  
1001-9282  
AU-HV

FOR: HUF ®

FOR: AKS ®  
CASI ®  
NEIMAN ®  
UBE ®  
WITTE ®  
YMOS ®

HV....  
1-854  
1001-9282  
AU-HV.P

FOR: HUF ®

FOR: EMOH ®  
FLORA ®  
KN ®  
LINDE ®  
POS ®  
WESCO ®

55-69  
BL-1I

33-54  
BL-1D

FOR: BLAU ®

Concerning the marks and commercial denominations see legal warning.  
Concieniente a las marcas y denominaciones comerciales ver aviso legal.  
Marka eta izendapen komertzialiei dagokienez, ikus lege-oharra.  
Concernant les marques et denominations commerciales voir la note dans l'index.

**JMA** Opening the future

**JMA** Opening the future

Beziehen auf die marke und handelsname sehen sie die notiz im Impressum.  
Relativamente às marcas e denominações comerciais, ver aviso legal.  
Jeśli chodzi o znaki i nazwy handlowe, patrz Informacje prawne.

FOR: VOLKSWAGEN (CHINA) ®

A...  
101-125  
501-598  
701-790  
BL-2

B...  
201-225  
BL-3

A  
BL-4

A 201-225  
BL-6

FOR: BLAU ®  
FOR: FORT ® -HK ® -WASO ®

DA-OA  
001-210  
ER-PN  
101-295  
ER  
001-195  
ER  
501-695  
FO-OA

FOR: FORD ®  
FOR: CASI ® -HUF ® -YMOS ®

OL  
001-210  
07R  
001-195  
7OR  
001-210  
FO-OL

O7L  
001-195  
7OL  
001-210  
OR  
001-210  
FO-OR

FOR: CASI ® -YMOS ®

FB  
001-210  
PO  
501-695  
PO  
101-295  
FO-PN

FOR: FORD ®  
FOR: AKS ® -CASI ® -UBE ® -WITTE ®

AN  
001-854  
1001-1918  
2001-2830  
3001-3890  
4001-5151  
6001-7086  
7001-8154  
8201-9282  
HU-AN

FOR: FORD ®  
FOR: AKS ® -CASI ® -UBE ® -WITTE ®

J...  
001-224  
PJ-1

FOR: PJ ®  
FOR: KIFERM ®

FOR: VOLKSWAGEN (CHINA) ®

J...  
001-224  
PJ-2

FOR: PJ ®  
FOR: KIFERM ®

J...  
001-224  
PJ-2.P

FOR: PJ ®  
FOR: KIFERM ®

AH...  
1-8154  
1001-9282  
VO-2

FOR: HUF ®  
FOR: AKS ® -CASI ® -UBE ® -WITTE ®

HV...  
1-8154  
1001-9282  
VO-HV.P1

2FF  
VO-8.P

AH...  
1-8154  
1001-9282  
VO-2.P

FOR: HUF ®  
FOR: AKS ® -CASI ® -UBE ® -WITTE ®

8...  
1...  
1001-3300  
AS-1D

7...  
6...  
1001-3300  
AS-24

FOR: ASSA ®

JC  
001-852  
CEM-JC

AK  
0001-1000  
FO-5

FOR: CEM ®

A...201-1050  
C...500-699  
H...601-1100  
HM...201-1050  
HUD-1

FOR: HUDSON ®

DF-F  
0001-1975  
HU-DF

FOR: HUF ®

DF-F  
0001-1975  
HU-DF.P

FOR: HUF ®

FOR: VOLKSWAGEN (CHINA) ®

AH...  
1-8154  
1001-9282  
VO-AH

HV...  
1-8154  
1001-9282  
VO-HV

VB-NV-MD...  
1-8154  
1001-9282  
VO-VB

N...  
VO-N

FOR: HUF ®  
FOR: AKS ® -CASI ® -UBE ® -WITTE ®

AH...  
1-8154  
1001-9282  
VO-AH.P

HV...  
1-8154  
1001-9282  
VO-HV.P

VB-NV-MD...  
1-8154  
1001-9282  
VO-VB.P

N...  
VO-N.P

FOR: HUF ®  
FOR: AKS ® -CASI ® -UBE ® -WITTE ®

AN...  
001-854  
1001-1918  
2001-2830  
3001-3890  
4001-5151  
6001-7086  
7001-8154  
8201-9282  
AU-AN

FOR: HUF ®  
FOR: AKS ® -CASI ® -UBE ® -WITTE ®

AN...  
001-854  
1001-1918  
2001-2830  
3001-3890  
4001-5151  
6001-7086  
7001-8154  
8201-9282  
AU-AN.P

FOR: HUF ®  
FOR: AKS ® -CASI ® -UBE ® -WITTE ®

FOR: VOLKSWAGEN (MEXICO) ®

SR  
001-240  
KSR  
001-240  
LSR  
001-240  
TSR  
001-240  
HU-SR

SE  
001-750  
SC  
401-630  
HU-SC

SU  
001-240  
401-630  
HU-SU

SX  
001-240  
HU-SX

SZ  
1-240  
HU-SZ

FOR: HUF ®  
FOR: AKS ®

..M...  
11-72.1-110  
VO-M

..M...  
11-72.1-110  
VO-M.P

..R...  
11-72.1-110  
VO-R

FOR: HUF ®  
FOR: AKS ® -CASI ® -WITTE ®

..M...  
11-72.1-110  
VO-M.P

..R...  
11-72.1-110  
VO-R.P

FOR: HUF ®  
FOR: AKS ® -CASI ® -WITTE ®

KA  
001-100  
AKS-1

FOR: AKS ®

FOR: VOLVO ®

FOR: VOLVO ®

AS-11

AS-1D

7...  
6...  
1001-3300  
AS-24

FOR: ASSA ®

JC  
001-852  
CEM-JC

AK  
0001-1000  
FO-5

FOR: CEM ®

A...201-1050  
C...500-699  
H...601-1100  
HM...201-1050  
HUD-1

FOR: HUDSON ®

DF-F  
0001-1975  
HU-DF

FOR: HUF ®

DF-F  
0001-1975  
HU-DF.P

FOR: HUF ®

FOR: VOLVO ®

DN-DH  
6001-8000  
HU-DH.P  
FOR: HUF ®

DN-DH  
6001-8000  
HU-DN.P  
FOR: HUF ®

FOR:  
ASTON MARTIN ®  
JAGUAR ®  
LAND ROVER  
MG ®  
ROVER ®  
VOLVO ®

FP  
626-750  
IN-1

FS  
01-99  
876-955  
IN-4

FR  
751-875  
UN-4

FOR: UNION ®

...6250-6499  
NE-9  
FOR: NEIMAN ®

...6250-6499  
NE-9.P  
FOR: NEIMAN ®

Concerning the marks and commercial denominations see legal warning.  
Conceniende a las marcas y denominaciones comerciales ver aviso legal.  
Marka eta izendapen komertzialiei dagokienez, ikus lege-oharra.  
Concernant les marques et denominations commerciales voir la note dans l'index.



FOR: VOLVO®

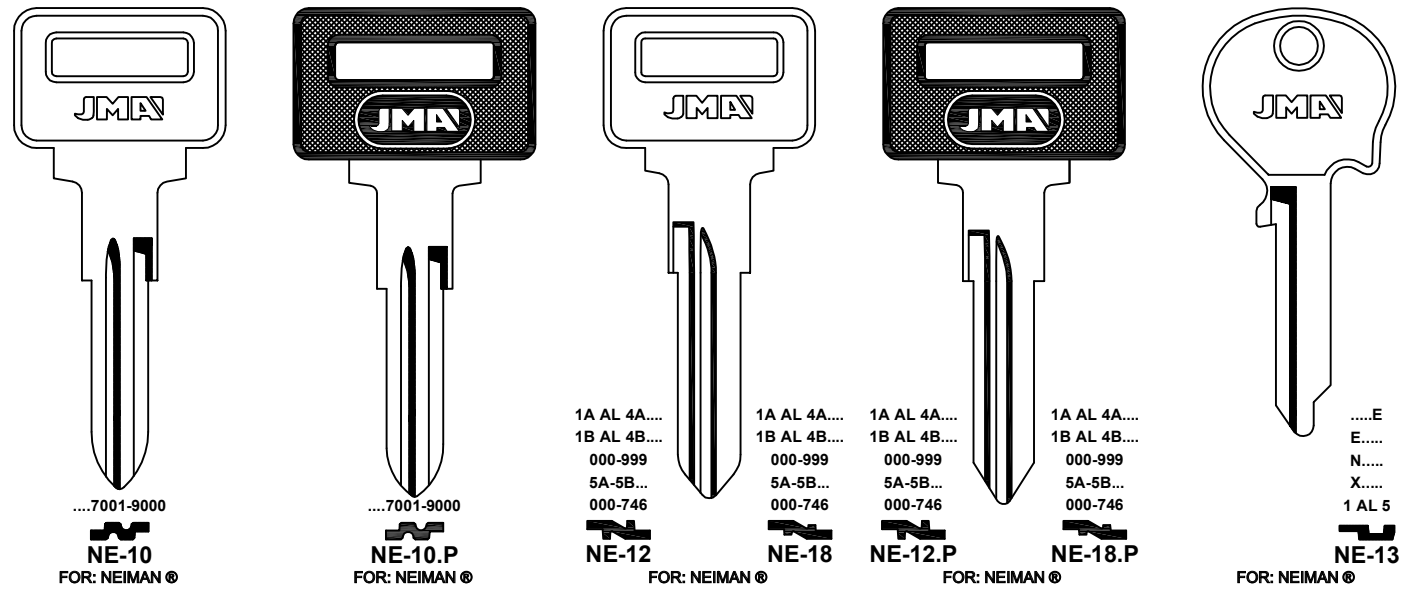

FOR: VOLVO®

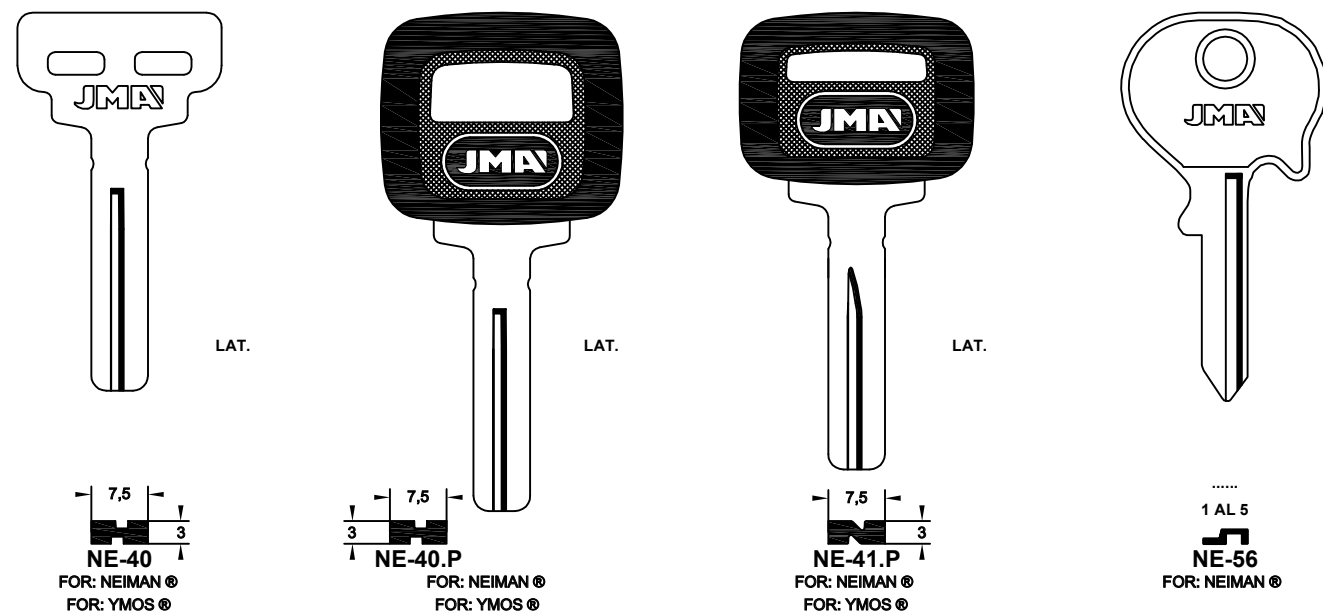

FOR: VOLVO®

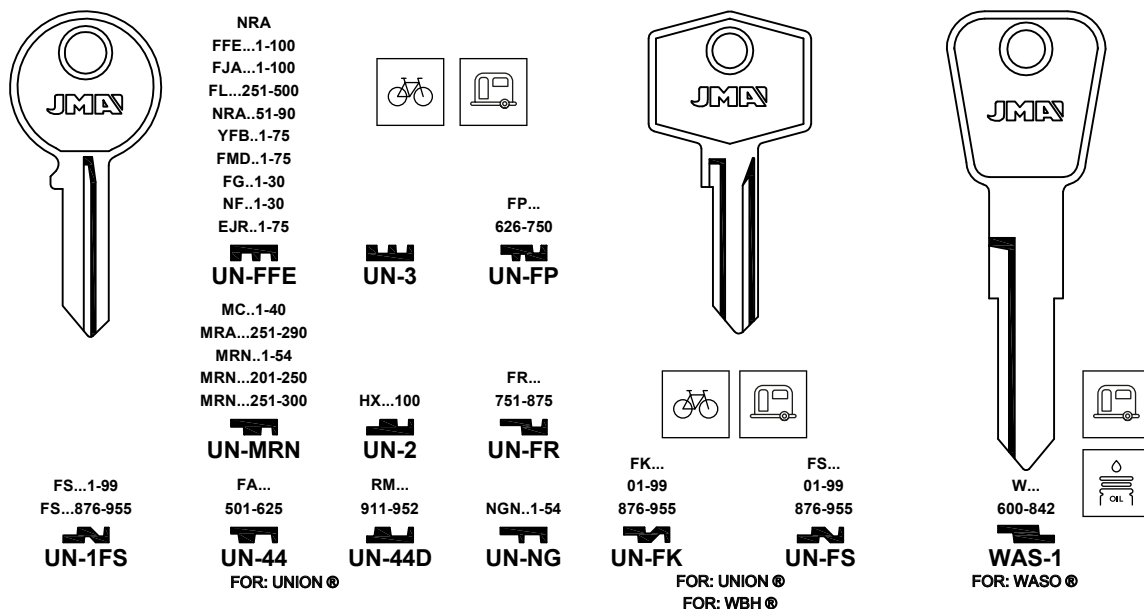

FOR: WARTBURG®

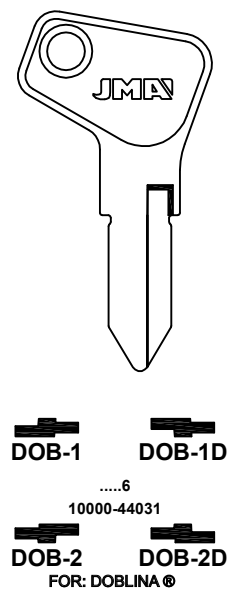

FOR: WARTBURG®

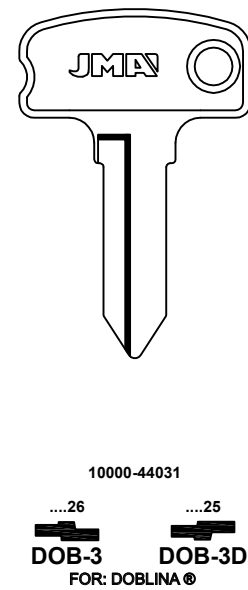

FOR: YAMAHA®

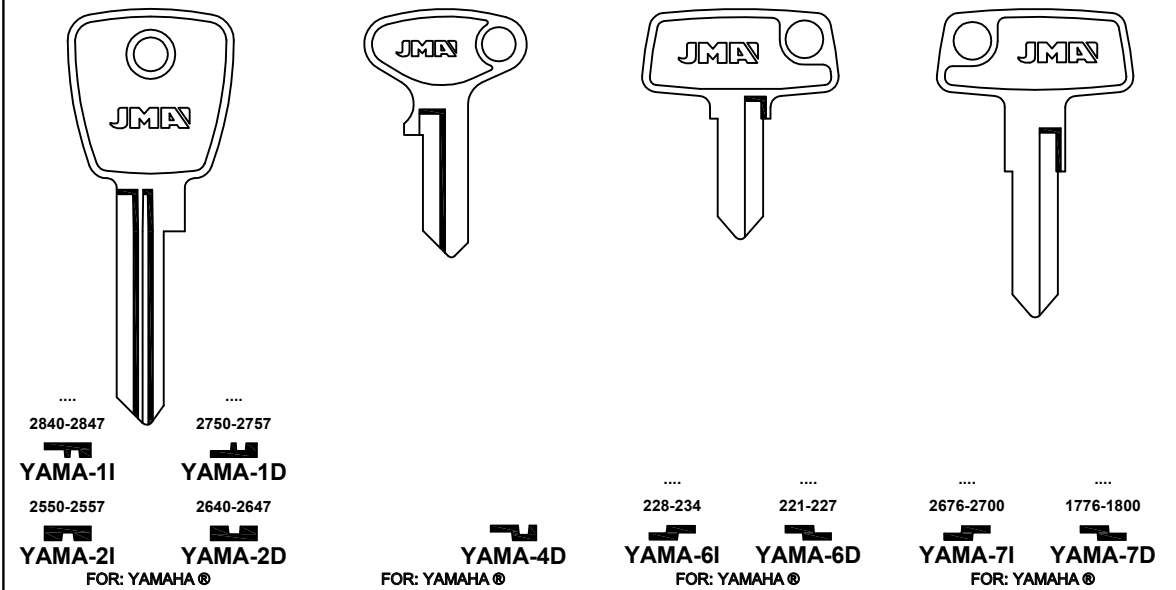

FOR: YAMAHA®

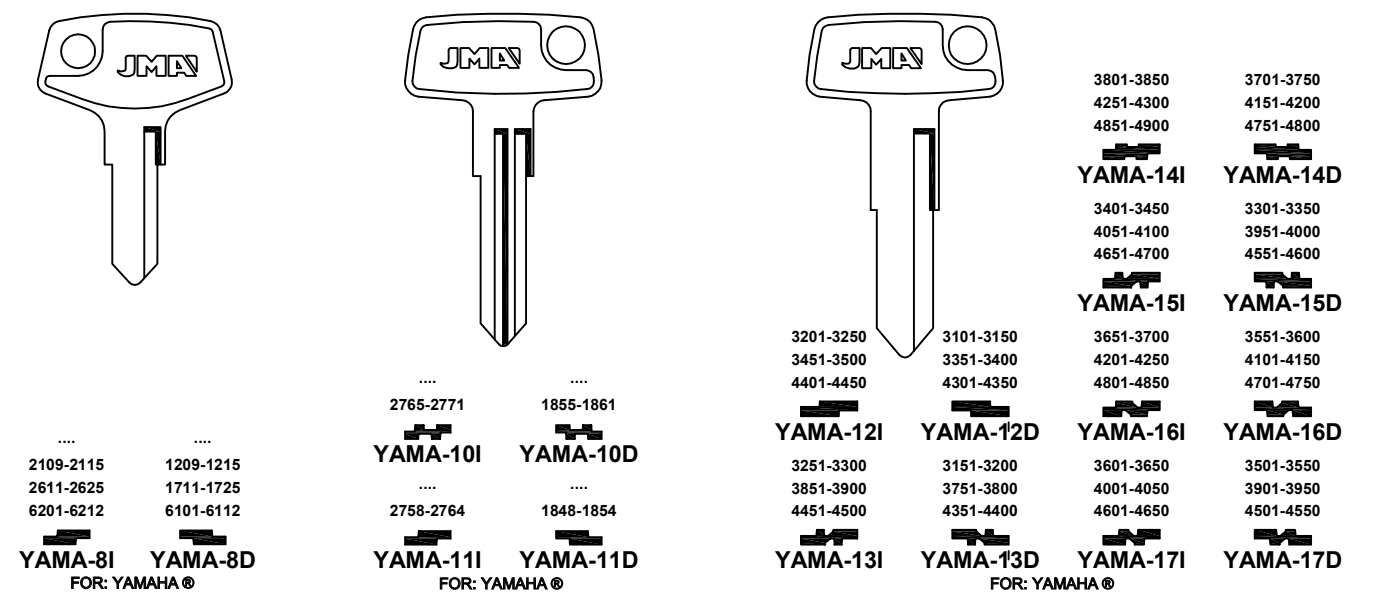

FOR: YAMAHA®

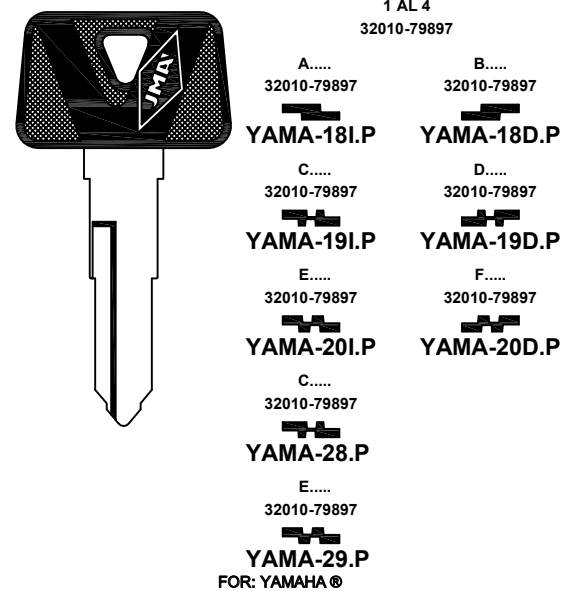

FOR: YUGO-ZASTAVA®

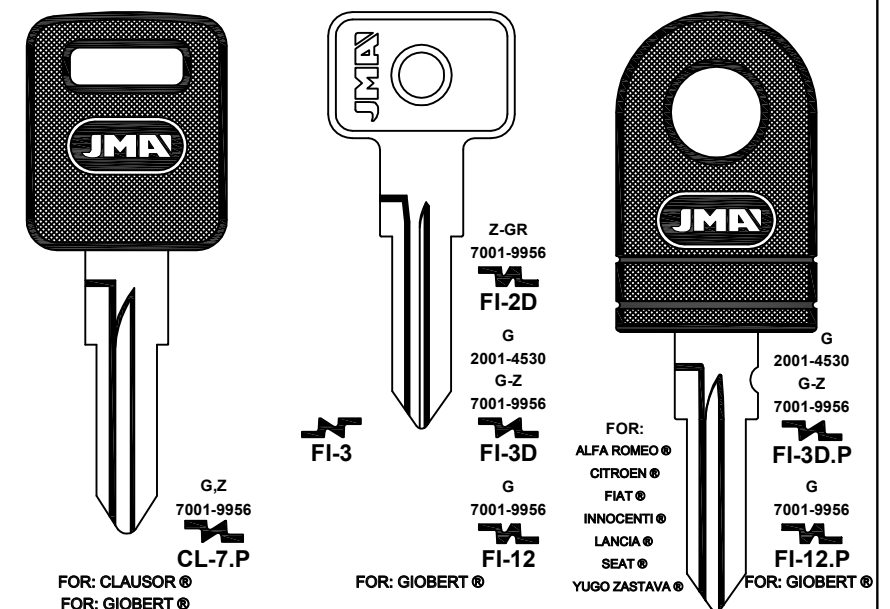

Concerning the marks and commercial denominations see legal warning.  
Concerniente a las marcas y denominaciones comerciales ver aviso legal.  
Marka eta izendapen komertzialiei dagokienez, ikus lege-oharra.  
Concernant les marques et denominations commerciales voir la note dans l'index.







FOR: ASTRA®

0501-3278  
0,4,6,8,9

AF-7I AF-7D  
AF-7I.P AF-7D.P

0501-1000  
3 4 3 4

IMS-3 AF-21 IMS-3.P AF-21.P

0501-1000  
1 2 1 2

IMS-5 AF-19 IMS-5.P AF-19.P

0501-1000  
3 4 3 4

IMS-13 AF-9D.P IMS-13.P AF-9D.P

FOR: SIPEA®  
FOR: SAFE®

FOR: SIPEA®  
FOR: SAFE®

FOR: SAFE®  
FOR: CROMODORA® -FIST® -JMSA®

FOR: SAFE®  
FOR: CROMODORA® -FIST® -JMSA®

FOR: BEDFORD®

FOR: L. & F.®

FOR: BEDFORD®

FOR: WASO®

FOR: BROCKWAY®

FOR: B & S®

FOR: HUDSON®

FOR: YALE®

FOR: YALE®

FOR: BEDFORD®

FOR: L. & F.®

FOR: L. & F.®

FOR: L. & F.®

FOR: NEIMAN®  
FOR: CLAUSOR®

FOR: NEIMAN®  
FOR: CLAUSOR®

FOR: DAF®

FOR: CHRYSLER®  
FOR: CLAUSOR® -NEIMAN®

FOR: CHRYSLER®  
FOR: CLAUSOR® -NEIMAN®

FOR: DAV®

FOR: DAV®

FOR: BEDFORD®

FOR: NEIMAN®

FOR: NEIMAN®

FOR: UNION®

FOR: UNION®

FOR: UNION®  
FOR: CEM®

FOR: DAF®

FOR: FORD®

FOR: FORD®

FOR: LAS®  
FOR: DUBOIS® -KIFERM® -PJ® -PK®

FOR: NEIMAN®  
FOR: CLAUSOR®

FOR: NEIMAN®  
FOR: CLAUSOR®

Concerning the marks and commercial denominations see legal warning.  
Concerniente a las marcas y denominaciones comerciales ver aviso legal.  
Marka eta izendapen komertzialiei dagokienez, ikus lege-oharra.  
Concernant les marques et denominations commerciales voir la note dans l'index.







FOR: FIAT IVECO®

**FI-3**  
 Z-GR  
 7001-9956  
 G  
 2001-4530  
 G-Z  
 7001-9956  
 FOR: GIOBERT®  
 FOR: YUGO ZASTAVA® -FIAT IVECO®

**FI-2D**  
 Z-GR  
 7001-9956  
 G  
 2001-4530  
 G-Z  
 7001-9956  
 FOR: GIOBERT®

**FI-2D.P3**  
 Z-GR  
 7001-9956  
 G  
 2001-4530  
 G-Z  
 7001-9956  
 FOR: GIOBERT®

**FI-3D**  
 G  
 2001-4530  
 G-Z  
 7001-9956  
 FOR: GIOBERT®

**FI-3D.P1**  
 G  
 2001-4530  
 G-Z  
 7001-9956  
 FOR: GIOBERT®

**FI-3D.P4**  
 G  
 2001-4530  
 G-Z  
 7001-9956  
 FOR: GIOBERT®

**FI-3D.P5**  
 G  
 2001-4530  
 G-Z  
 7001-9956  
 FOR: GIOBERT®

**FI-12**  
 G  
 7001-9956  
 FOR: GIOBERT®

**FI-12.P3**  
 G  
 7001-9956  
 FOR: GIOBERT®

**FI-12.P1**  
 G  
 7001-9956  
 FOR: GIOBERT®

FOR: FIAT IVECO®

**FI-4D**  
 FOR: GIOBERT®  
 FOR: IACAM®

**FI-5I**  
 FOR: GIOBERT®

**FI-5D**  
 FOR: GIOBERT®

**FI-6I**  
 FOR: GIOBERT®

**FI-6I.P**  
 FOR: GIOBERT®

**FI-6I.P1**  
 FOR: GIOBERT®

**FI-6I.P2**  
 FOR: GIOBERT®

FOR:  
 ALFA ROMEO®  
 AUTOBANCHI®  
 CITROEN®  
 FERRARI®  
 FIAT®  
 INNOCENTI®  
 LANCIA®  
 PEUGEOT®  
 YUGO ZASTAVA®  
 CAGIVA®  
 DUCATI®  
 FANTIC MOTOR®  
 GARELLI®  
 GILERA®

K 3301-4886  
 K 7001-8092  
 T 5000-6027  
 T 7001-8092  
 S 0501-3278  
 H 7001-8092

K 3301-4886  
 K 7001-8092  
 T 5000-6027  
 T 7001-8092  
 S 0501-3278  
 H 7001-8092

K 3301-4886  
 K 7001-8092  
 T 5000-6027  
 T 7001-8092  
 S 0501-3278  
 H 7001-8092

FOR:  
 FERRARI®  
 FIAT®  
 INNOCENTI®  
 LANCIA®

FOR:  
 AUDI®  
 HONDA®  
 MG®  
 ROVER®  
 BEDFORD®  
 FIAT IVECO®  
 VOLVO®

FOR: FIAT IVECO®

**FI-9I**  
 FOR: GIOBERT®

**FI-9I.P**  
 FOR: GIOBERT®

**FI-11**  
 FOR: GIOBERT®

**FI-11.P**  
 FOR: GIOBERT®

**FIS-1D**  
 FOR: FIST®

N 6001-7000  
 J 3001-6732  
 V 0001-3051  
 V 5001-8058  
 AB 6001-6891

N 6001-7000  
 J 3001-6732  
 V 0001-3051  
 V 5001-8058  
 AB 6001-6891

FOR: FIAT IVECO®

**IMS-3**  
 3  
 0501-1000  
 FOR: SAFE®  
 FOR: CROMODORA® -FIST® -IMSA®

**AF-21**  
 4  
 0501-1000  
 FOR: SAFE®  
 FOR: CROMODORA® -FIST® -IMSA®

**IMS-3.P**  
 3  
 0501-1000  
 FOR: SAFE®  
 FOR: CROMODORA® -FIST® -IMSA®

**AF-21.P**  
 4  
 0501-1000  
 FOR: SAFE®  
 FOR: CROMODORA® -FIST® -IMSA®

**IMS-5**  
 1  
 0501-1000  
 FOR: SAFE®  
 FOR: CROMODORA® -FIST® -IMSA®

**AF-19**  
 2  
 0501-1000  
 FOR: SAFE®  
 FOR: CROMODORA® -FIST® -IMSA®

**IMS-5.P**  
 1  
 0501-1000  
 FOR: SAFE®  
 FOR: CROMODORA® -FIST® -IMSA®

**AF-19.P**  
 2  
 0501-1000  
 FOR: SAFE®  
 FOR: CROMODORA® -FIST® -IMSA®

**IMS-13**  
 FOR: L. & F.®

**IMS-13.P**  
 FOR: L. & F.®

**LF-RO**  
 RO  
 BL...N  
 1001-2000  
 FOR: L. & F.®

**NE-1**  
 ...2001-4949  
 GM  
 ...2001-3000  
 FOR: NEIMAN®  
 FOR: CLAUSOR®

**NE-1D**  
 FOR: NEIMAN®  
 FOR: CLAUSOR®

FOR:  
 AUSTIN®  
 CARBODIES®  
 INNOCENTI®  
 LAND ROVER®  
 LOTUS®  
 MASERATI®  
 OM IVECO®  
 ROVER®  
 VAUXHALL®  
 BEDFORD®  
 FIAT IVECO®

FOR:  
 AUSTIN®  
 CARBODIES®  
 INNOCENTI®  
 LAND ROVER®  
 LOTUS®  
 MASERATI®  
 OM IVECO®  
 ROVER®  
 VAUXHALL®  
 BEDFORD®  
 FIAT IVECO®

FOR:  
 AUDI®  
 HONDA®  
 MG®  
 ROVER®  
 BEDFORD®  
 FIAT IVECO®  
 VOLVO®

FOR: FIAT IVECO®

**NE-1.P**  
 FOR: NEIMAN®  
 FOR: CLAUSOR®

**NE-1D.P**  
 FOR: NEIMAN®  
 FOR: CLAUSOR®

**PRE-3**  
 FOR: PRESTA®  
 FOR: LAPORTE®

**PRE-11**  
 FOR: PRESTA®  
 FOR: LAPORTE®

**SIP-1**  
 FOR: SIPEA®

**VO-1**  
 FOR: HUF®  
 FOR: NEIMAN®

...124-197  
 ...501-598  
 ...701-790  
 ...G06-G10  
 ...0G1-1G0  
 A...101-125  
 A...701-790  
 G...001-100

Z...501-3278  
 P...501-3278

FOR: FIAT IVECO®

**VO-AH**  
 AH...  
 1-8154  
 1001-9282  
 FOR: HUF®  
 FOR: AKS® -CASI® -UBE® -WITTE®

**VO-AH.P**  
 AH...  
 1-8154  
 1001-9282  
 FOR: HUF®  
 FOR: AKS® -CASI® -UBE® -WITTE®

**VO-HV**  
 HV...  
 1-8154  
 1001-9282  
 FOR: HUF®  
 FOR: AKS® -CASI® -UBE® -WITTE®

**VO-HV.P**  
 HV...  
 1-8154  
 1001-9282  
 FOR: HUF®  
 FOR: AKS® -CASI® -UBE® -WITTE®

**VO-VB**  
 VB-NV-MD...  
 1-8154  
 1001-9282  
 FOR: HUF®  
 FOR: AKS® -CASI® -UBE® -WITTE®

**VO-VB.P**  
 VB-NV-MD...  
 1-8154  
 1001-9282  
 FOR: HUF®  
 FOR: AKS® -CASI® -UBE® -WITTE®

**VO-N**  
 N...  
 001-854  
 1001-1918  
 2001-2830  
 3001-3890  
 4001-5151  
 6001-7086  
 7001-8154  
 8201-9282  
 FOR: HUF®  
 FOR: AKS® -CASI® -UBE® -WITTE®

**VO-N.P**  
 N...  
 001-854  
 1001-1918  
 2001-2830  
 3001-3890  
 4001-5151  
 6001-7086  
 7001-8154  
 8201-9282  
 FOR: HUF®  
 FOR: AKS® -CASI® -UBE® -WITTE®

**AU-AN**  
 AN...  
 001-854  
 1001-1918  
 2001-2830  
 3001-3890  
 4001-5151  
 6001-7086  
 7001-8154  
 8201-9282  
 FOR: HUF®  
 FOR: AKS® -CASI® -UBE® -WITTE®

**AU-AN.P**  
 AN...  
 001-854  
 1001-1918  
 2001-2830  
 3001-3890  
 4001-5151  
 6001-7086  
 7001-8154  
 8201-9282  
 FOR: HUF®  
 FOR: AKS® -CASI® -UBE® -WITTE®

FOR: FORD®

**FO-E/TC**  
 FOR: FORD®  
 FOR: CASI® -CEM® -CLAUSOR®  
 FOR: KOLB® -NEIMAN®

AK  
 0001-1000  
 TC  
 0001-1000  
 TX  
 0001-1859

Concerning the marks and commercial denominations see legal warning.  
 Concerniente a las marcas y denominaciones comerciales ver aviso legal.  
 Marka eta izendapen komertzialiei dagokienez, ikus lege-oharra.  
 Concernant les marques et denominations commerciales voir la note dans l'index.





FOR: GM (CHEVROLET)®

H  
001-400  
2221-2620  
4441-4640  
4641-5143  
E  
2001-3000

H  
001-400  
2221-2620  
4441-4640  
4641-5143  
E  
2001-3000

A....  
0001-0400  
2221-2620  
4441-4640  
B....  
5001-6000  
C....  
6001-7000  
M....  
5551-5950  
6661-7060  
7771-8170  
8814-9280  
N....  
1921-2220

MIT-21 FOR: MITSUBISHI®  
MIT-2D FOR: MITSUBISHI®  
MIT-21.P FOR: MITSUBISHI®  
MIT-2D.P FOR: MITSUBISHI®  
TOYO-2 FOR: TOYOTA®  
FOR: TOKAJ® -RIKA®

FOR: GM (GMC)®

X  
0001-8000  
DAT-6 DAT-6D

Y  
0001-8000  
8001-9000  
DAT-7

FOR: NISSAN®  
FOR: DATSUN®

FOR: ISUZU®

X  
0001-8000  
DAT-6 DAT-6D

X  
0001-8000  
8001-9000  
DAT-7.P1 DAT-6D.P1

Y  
0001-8000  
8001-9000  
DAT-7.P1

FOR: NISSAN®  
FOR: DATSUN®

A....  
8001-9400  
ISU-1

FOR: ISUZU®

FOR: GM (GMC)®

X  
0001-8000  
DAT-6.P1 DAT-6D.P1

Y  
0001-8000  
8001-9000  
DAT-7.P1

FOR: NISSAN®  
FOR: DATSUN®

A....  
8001-9400  
ISU-2

FOR: ISUZU®

FOR: GMC®

U  
1-2000  
GM-5

FOR: G.M.®  
FOR: BRIGGS S.®

U  
1-2000  
GM-5.P

FOR: G.M.®  
FOR: BRIGGS S.®

FOR: ISUZU®

A....  
8001-9400  
ISU-2

H  
001-400  
2221-2620  
4441-4640  
4641-5143  
E  
2001-3000

MIT-11 MIT-1D  
FOR: MITSUBISHI®

H  
001-400  
2221-2620  
4441-4640  
4641-5143  
E  
2001-3000

MIT-11.P MIT-1D.P  
FOR: MITSUBISHI®

E  
5001-7000  
MIT-7.P

E  
5001-7000  
7001-7679  
MIT-15.P

FOR: MITSUBISHI®

FOR: IVECO®

FOR:  
AUTOBIANCHI®  
CITROEN®  
FERRARI®  
FIAT®  
LANCIA®  
PEUGEOT®  
YUGO ZASTAVA  
CAGIVA®  
DUCATI®  
FANTIC MOTOR®  
GARELLI®  
GILERA®

K 3301-4886  
K 7001-8092  
T 5000-6027  
T 7001-8092  
S 0501-3278  
H 7001-8092

FI-6I.P3

FOR: GIOBERT®

FOR: HINO®

K....  
001-400/1511-1910  
2221-2620/3731-4570  
5001-6368  
R....  
401-800/1112-1510  
2621-3020/3331-3730  
5001-6924/8001-9368  
S....  
5951-6350/7061-7460  
8171-8570/9281-9680  
D....  
6001-7042  
TOYO-K1

F....  
5951-6350  
7061-7460  
8171-8570  
9281-9680  
P....  
7001-8500  
TOYO-4

C....  
6001-7042  
TOYO-14

FOR: TOYOTA®  
FOR: TOKAJ® -RIKA®

K....  
001-400/1511-1910  
2221-2620/3731-4570  
5001-6368  
R....  
401-800/1112-1510  
2621-3020/3331-3730  
5001-6924/8001-9368  
S....  
5951-6350/7061-7460  
8171-8570/9281-9680  
D....  
6001-7042  
TOYO-K1.P

F....  
5951-6350  
7061-7460  
8171-8570  
9281-9680  
P....  
7001-8500  
TOYO-4.P

C....  
6001-7042  
TOYO-14.P

FOR: TOYOTA®  
FOR: TOKAJ® -RIKA®

FOR: KENWORTH®

DA-OA  
001-210  
ER-PN  
101-295  
ER  
001-195  
ER  
501-695  
PO  
101-295  
FO-OA

FB  
001-210  
PO  
501-695  
PO  
101-295  
FO-PN

FOR: FORD®  
FOR: CASI® -YMOŠ®

OL  
001-210  
07R  
001-195  
7OR  
001-210  
FO-OL

O7L  
001-195  
7OL  
001-210  
OR  
001-210  
FO-OR

FOR: FORD®  
FOR: CASI® -YMOŠ®

NSP....  
4000-4999  
7001-9000  
E....  
2001-3000  
4001-5000  
S....  
2001-3000  
NE-11

FOR: NEIMAN®  
FOR: DAF® -KENWORTH®

NSP....  
4000-4999  
7001-9000  
E....  
2001-3000  
4001-5000  
S....  
2001-3000  
NE-11.P

FOR: NEIMAN®  
FOR: DAF® -KENWORTH®

FOR: MACK®

LAT.

AMM-1

FOR: AMERICAN MOT.®

Concerning the marks and commercial denominations see legal warning.  
Concerniente a las marcas y denominaciones comerciales ver aviso legal.  
Marka eta izendapen komertzialiei dagokienez, ikus lege-oharra.  
Concernant les marques et denominations commerciales voir la note dans l'index.



FOR: MACK®

**BAS-4**  
FOR: BASCO®  
FOR: ELMO®-HERSEE E.®-ILLINOIS®-YALE®

**BH-1**  
FOR: BOSCH®  
FOR: NEIMAN®

**BH-1.P**  
FOR: BOSCH®  
FOR: NEIMAN®

**BS-1I**  
FOR: B & S®  
FOR: DEXTER®-POLLAK®-BOBCAT®

**DAV-1**  
FOR: DAV®

FOR: MACK®

**DAV-1.P**  
FOR: DAV®

**MAK-1**  
FOR: MACK®

**RO-1I**  
**RO-1D**  
FOR: RONIS®  
FOR: ABSA®-FROSER®-PJ®-SADV®

**RO-2I**  
**RO-2D**  
**RO-4I**  
**RO-4D**  
**RO-6I**  
**RO-6D**  
FOR: RONIS®  
FOR: ABSA®-FROSER®-PJ®-SADV®

**YA-11I**  
**YA-11D**  
FOR: RONIS®

FOR: ABUS®  
BENDIX®  
CAB®  
CHICAGO®  
COLE HERSEE®

USA GB  
ALU.

FOR: MAGIRUS DEUTZ®

**BH-1**  
FOR: BOSCH®  
FOR: NEIMAN®

**BH-1.P**  
FOR: BOSCH®  
FOR: NEIMAN®

**BH-2**  
FOR: BOSCH®

**LAS-R**  
**LAS-V**  
**LAS-Y**  
FOR: LAS®  
FOR: DUBOIS®-KIFERM®-PJ®-PK®

**PRE-1I**  
**PRE-3**  
FOR: PRESTA®  
FOR: LAPORTE®

FOR: MAGIRUS DEUTZ®

**RO-2I**  
FOR: RONIS®  
FOR: ABSA®-FROSER®-PJ®-SADV®

**RO-2D**  
**RO-4I**  
**RO-4D**  
**RO-6I**  
**RO-6D**  
FOR: RONIS®  
FOR: ABSA®-FROSER®-PJ®-SADV®

FOR: MAN®

**BH-1**  
FOR: BOSCH®  
FOR: NEIMAN®

**BH-1.P**  
FOR: BOSCH®  
FOR: NEIMAN®

**BL-2**  
**BL-3**  
**BL-4**  
**BL-6**  
**BL-4D**  
**BL-6D**  
FOR: BLAU®  
FOR: FORT®-HK®-WASO®

FOR: MAN®

**FO-OL**  
FOR: FORD®  
FOR: CASI®-YMOŠ®

**FO-OR**  
FOR: FORD®

**HU-MN**  
FOR: HUF®

FOR: MAN®

**HU-SR**  
FOR: HUF®  
FOR: AKS®

FOR: MERCEDES ARG.®

**VO-M**  
**VO-R.P**  
FOR: AKS®-CASI®-WITTE®

**ME-9.P**  
FOR: HUF®

Concerning the marks and commercial denominations see legal warning.  
Concerniente a las marcas y denominaciones comerciales ver aviso legal.  
Marka eta izendapen komertzialiei dagokienez, ikus lege-oharra.  
Concernant les marques et denominations commerciales voir la note dans l'index.

**JMA** Opening the future

**JMA** Opening the future

Beziehen auf die Marke und Handelsname sehen Sie die Notiz im Impressum.  
Relativamente às marcas e denominações comerciais, ver aviso legal.  
Jeśli chodzi o znaki i nazwy handlowe, patrz Informacje prawne.

FOR: MERCEDES (ARGENTINA) ®

TX  
ME-13D.P  
FOR: HUF ®

ME-14.P  
FOR: HUF ®

ME-HD.P  
FOR: HUF ®

ME-HZ.P  
FOR: HUF ®

ME-HM.P  
FOR: YMOS ®

ME-HML.P  
FOR: HUF ®  
FOR: YMOS ®

..HF..  
1-99/1-99  
HD 4001-7350  
NZ 0001-1400  
NZ 2001-2500  
NZ 1-99/1-99

HF 0001-1200  
NM....  
0001-1200  
4001-7350

HZ 0001-1400  
HZ 2001-3500  
HZ 4001-5000  
ND  
4001-5795  
5801-7350  
HZ 1-99/1-99

HM 0001-1200  
2501-3500  
4001-5795  
5801-7350  
NF 0001-1200  
..NF..  
1-99/1-99

HM 0001-1200  
2501-3500  
4001-5795  
5801-7350  
NF 0001-1200  
..NF..  
1-99/1-99

FOR: NISSAN ®

X  
0001-8000  
DAT-6  
DAT-6D

Y  
0001-8000  
8001-9000  
DAT-7  
FOR: NISSAN ®  
FOR: DATSUN ®

X  
0001-8000  
DAT-6.P  
DAT-6D.P

Y  
0001-8000  
8001-9000  
DAT-7.P  
FOR: NISSAN ®  
FOR: DATSUN ®

X  
0001-9000  
DAT-12  
FOR: NISSAN ®

FOR: MERCEDES ®

FOR: MITSUBISHI ®

L  
001-300  
ME-L  
FOR: HUF ®  
FOR: IMSA ® -YMOS ®

S  
101-295  
401-465  
501-695  
ME-S  
FOR: HUF ®  
FOR: CASI ®

H  
001-400  
2221-2620  
4441-4640  
4641-5143  
E  
2001-3000  
MIT-2I  
FOR: MITSUBISHI ® -SUZUKI ®

H  
001-400  
2221-2620  
4441-4640  
4641-5143  
E  
2001-3000  
MIT-2I.P  
MIT-2D  
FOR: MITSUBISHI ® -SUZUKI ®

H  
001-400  
2221-2620  
4441-4640  
4641-5143  
E  
2001-3000  
MIT-9  
FOR: MITSUBISHI ® -SUZUKI ®

FOR: NISSAN ®

FOR: PEGASO ®

.....  
...A/Z  
B-C-D-E  
1/9...A/Z  
1/9...A/Z  
.....A/Z  
B-D-E-G-H-J  
.1/9...A/Z  
.1/9...A/Z  
E-M-N-P-R  
NE-22.P  
FOR: NEIMAN ®  
CLAUSOR ®

FOR:  
A.MOTORS  
RENAULT ®  
DAF ®  
NISSAN ®

ROS-2  
FOR: ROSS ®

FOR:  
AKS ®  
CASI ®  
NEIMAN ®  
UBE ®  
WITTE ®  
YMOS ®

HV....  
1-854  
1001-9282  
AU-1  
FOR: HUF ®

FOR:  
AKS ®  
CASI ®  
NEIMAN ®  
UBE ®  
WITTE ®  
YMOS ®

HV....  
1-854  
1001-9282  
AU-HV  
FOR: HUF ®

FOR:  
AKS ®  
CASI ®  
NEIMAN ®  
UBE ®  
WITTE ®  
YMOS ®

HV....  
1-854  
1001-9282  
AU-HV.P  
FOR: HUF ®

FOR: MITSUBISHI ®

FOR: NISSAN ®

H  
0001-0400  
2221-2620  
4441-5143  
MIT-10  
FOR: MITSUBISHI ®

H  
0001-0400  
2221-2620  
4441-5143  
MIT-11D  
FOR: MITSUBISHI ®

.....  
...A/Z  
B-C-D-E  
1/9...A/Z  
1/9...A/Z  
.....A/Z  
B-D-E-G-H-J  
.1/9...A/Z  
.1/9...A/Z  
E-M-N-P-R  
CHR-3  
FOR: CHRYSLER ®  
FOR: CLAUSOR ® -NEIMAN ®

FOR:  
A.MOTORS  
CITROEN ®  
MAZDA ®  
PEUGEOT ®  
RENAULT ®  
TALBOT  
DAF ®  
NISSAN ®  
PEGASO ®

CHR-5  
FOR: CHRYSLER ®  
FOR: ROSS ®

FOR: PEGASO ®

A...  
101-125  
501-598  
701-790  
BL-2  
B...  
201-225  
BL-3

A  
BL-4  
BL-6  
FOR: BLAU ®  
FOR: FORT ® -HK ® -WASO ®

.....  
...A/Z  
B-C-D-E  
1/9...A/Z  
1/9...A/Z  
.....A/Z  
B-D-E-G-H-J  
.1/9...A/Z  
.1/9...A/Z  
E-M-N-P-R  
CHR-3  
FOR: CHRYSLER ®  
FOR: CLAUSOR ® -NEIMAN ®

FOR:  
A.MOTORS  
CITROEN ®  
MAZDA ®  
PEUGEOT ®  
RENAULT ®  
TALBOT  
DAF ®  
NISSAN ®  
PEGASO ®

.....  
...A/Z  
B-C-D-E  
1/9...A/Z  
1/9...A/Z  
.....A/Z  
B-D-E-G-H-J  
.1/9...A/Z  
.1/9...A/Z  
E-M-N-P-R  
CHR-3.P  
FOR: CHRYSLER ®  
FOR: CLAUSOR ® -NEIMAN ®

FOR:  
A.MOTORS  
CITROEN ®  
MAZDA ®  
PEUGEOT ®  
RENAULT ®  
TALBOT  
DAF ®  
NISSAN ®  
PEGASO ®

3  
0501-1000  
IMS-3  
1  
0501-1000  
IMS-5  
IMS-13  
FOR: CROMODORA ® -FIST ® -JMSA ®

4  
0501-1000  
AF-21  
2  
0501-1000  
AF-19  
FOR: SAFE ®

Concerning the marks and commercial denominations see legal warning.  
Concieniente a las marcas y denominaciones comerciales ver aviso legal.  
Marka eta izendapen komertzialiei dagokienez, ikus lege-oharra.  
Concernant les marques et denominations commerciales voir la note dans l'index.



FOR: PEGASO ®

**IMS-3.P**  
 0501-1000  
 FOR: SAFE ®  
 FOR: CROMODORA ® -FIST ® -IMSA ®

**AF-21.P**  
 0501-1000  
 FOR: NEIMAN ®  
 FOR: CLAUSOR ®

**ROS-2**  
 FOR: ROSS ®

**VO-AH**  
 AH....  
 1-8154  
 1001-9282  
 HV....  
 1-8154  
 1001-9282  
 VO-HV  
 VB-NV-MD....  
 1-8154  
 1001-9282  
 VO-VB  
 N....  
 VO-N  
 FOR: HUF ®  
 FOR: AKS ® -CASI ® -UBE ® -WITTE ®

**AN....**  
 001-854  
 1001-1918  
 2001-2830  
 3001-3890  
 4001-5151  
 6001-7086  
 7001-8154  
 8201-9282  
**AU-AN**

FOR: RENAULT SAVIEM ®

**CHR-3**  
 FOR: CHRYSLER ®  
 FOR: CLAUSOR ® -NEIMAN ®

**CHR-3.P**  
 FOR: CHRYSLER ®  
 FOR: CLAUSOR ® -NEIMAN ®

**DAV-1**  
 FOR: DAV ®

**DAV-1.P**  
 FOR: DAV ®

**LAS-R**  
 FOR: LAS ®

**LAS-V**  
 FOR: LAS ®

**LAS-Y**  
 FOR: LAS ®

**LAS-R**  
 FOR: DUBOIS ® -KIFERM ® -PJ ® -PK ®

FOR: PEGASO ®

**VO-AH.P**  
 AH....  
 1-8154  
 1001-9282  
 HV....  
 1-8154  
 1001-9282  
 VO-HV.P  
 VB-NV-MD....  
 1-8154  
 1001-9282  
 VO-VB.P  
 N....  
 VO-N.P  
 FOR: HUF ®  
 FOR: AKS ® -CASI ® -UBE ® -WITTE ®

**AN....**  
 001-854  
 1001-1918  
 2001-2830  
 3001-3890  
 4001-5151  
 6001-7086  
 7001-8154  
 8201-9282  
**AU-AN.P**

FOR: PIAGGIO ®

**AF-7I**  
 A  
 0501-3278  
 0,4,6,8,9  
 H  
 O1-78  
 AF-8I  
 F  
 O1-78  
 AF-9I  
 FOR: SIPEA ®  
 FOR: SAFE ®

**AF-7D**  
 G  
 O1-78  
 AF-8D  
 E  
 O1-78  
 AF-9D  
 FOR: SIPEA ®  
 FOR: SAFE ®

**AF-8I.P**  
 H  
 O1-78  
 AF-9I.P  
 F  
 O1-78  
 FOR: SIPEA ®  
 FOR: SAFE ®

**AF-8D.P**  
 G  
 O1-78  
 AF-9D.P  
 E  
 O1-78  
 FOR: SIPEA ®  
 FOR: SAFE ®

**FAB-1**  
 2  
 100-309  
 FOR: FAAB ®

FOR: RENAULT SAVIEM ®

**LMP-3**  
 35001-36177  
 70001-72500  
 75000-77500  
 1AA-7FZ  
 FOR: LMP ®  
 FOR: GELBON ® -SEIMA ®

**LMP-4**  
 FOR: LMP ®  
 FOR: GELBON ® -SEIMA ®

**LMP-5**  
 FOR: LMP ®  
 FOR: GELBON ® -SEIMA ®

**LMP-4.P1**  
 FOR: LMP ®  
 FOR: GELBON ® -SEIMA ®

**LMP-5.P1**  
 FOR: LMP ®  
 FOR: GELBON ® -SEIMA ®

**NE-3**  
 FOR: NEIMAN ®  
 FOR: CLAUSOR ®

**NE-3D**  
 FOR: NEIMAN ®  
 FOR: CLAUSOR ®

**NE-3.P**  
 FOR: NEIMAN ®  
 FOR: CLAUSOR ®

**NE-3.P1**  
 FOR: NEIMAN ®  
 FOR: CLAUSOR ®

FOR: PIAGGIO ®

**FEM-1I**  
 F  
 01-78  
**FEM-1D**  
 E  
 01-78  
**FEM-2I**  
 H  
 01-78  
**FEM-2D**  
 G  
 01-78  
**FEM-3I**  
 FOR: FEMSA ®

**FEM-3D**  
 FOR: FEMSA ®

**NE-6**  
 FOR: NEIMAN ®

**NE-6.P**  
 FOR: NEIMAN ®

FOR: RENAULT SAVIEM ®

**BH-1**  
 FOR: BOSCH ®  
 FOR: NEIMAN ®

**BH-1.P**  
 FOR: BOSCH ®  
 FOR: NEIMAN ®

FOR: RENAULT SAVIEM ®

**NE-3.P2**  
 FOR: NEIMAN ®  
 FOR: CLAUSOR ®

**NE-19**  
 FOR: NEIMAN ®

**NE-19.P**  
 FOR: NEIMAN ®

**NE-22.P**  
 FOR: NEIMAN ®  
 FOR: CLAUSOR ®

**NE-28**  
 FOR: NEIMAN ®

Concerning the marks and commercial denominations see legal warning.  
 Concerniente a las marcas y denominaciones comerciales ver aviso legal.  
 Marka eta izendapen komertzialiei dagokienez, ikus lege-oharra.  
 Concernant les marques et denominations commerciales voir la note dans l'index.

**JMA** Opening the future

**JMA** Opening the future

Beziehen auf die marke und handelsname sehen sie die notiz im Impressum.  
 Relativamente às marcas e denominações comerciais, ver aviso legal.  
 Jeśli chodzi o znaki i nazwy handlowe, patrz Informacje prawne.



FOR: RENAULT SAVIEM®

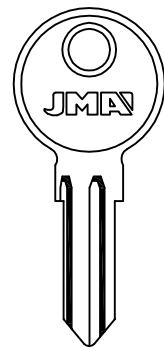

J...  
001-224  
PJ-1  
FOR: PJ®  
FOR: KIFERM®

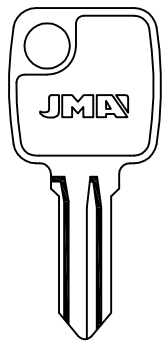

J...  
001-224  
PJ-2  
FOR: PJ®  
FOR: KIFERM®

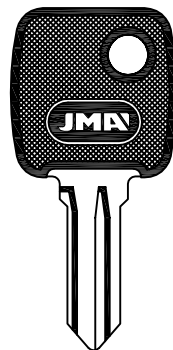

J...  
001-224  
PJ-2.P  
FOR: PJ®  
FOR: KIFERM®

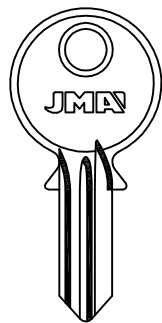

A8..AA-DS  
..8AB-ZZ  
S...385-402  
RO-11

A9..AA-DS  
..8AB-ZZ  
S...403-420  
RO-1D

FOR: RONIS®  
FOR: ABSA® -FROSER® -PJ® -SADV®

..4AB-ZZ  
S...331-348  
RO-2I

AA-JZ  
A4../A.4.  
RO-4I

AB-ZZ  
..6  
S...349-366  
RO-6I

..3AB-ZZ  
...1 AL 4  
RO-2D

AA-JZ  
A3../A.3.  
S...213-246  
RO-4D

AB-ZZ  
..7  
S...367-384  
RO-6D

FOR: RENAULT SAVIEM®

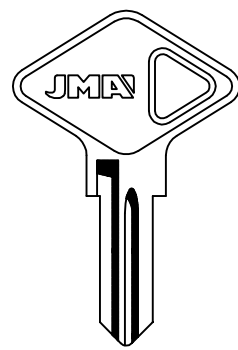

70.....  
1 AL 3  
...1-975  
RO-15  
FOR: RONIS®

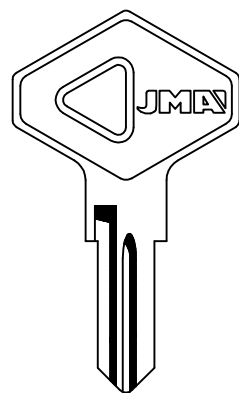

77....  
0 AL 3  
RO-17  
FOR: RONIS®

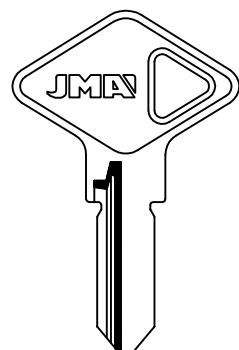

1R...000-999  
2R...1000-1837  
3R...000-665  
VA-7  
FOR: VACHETTE®

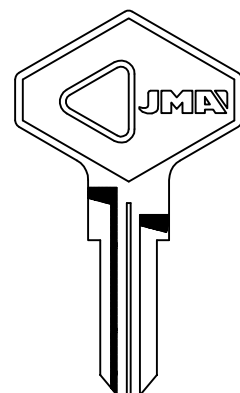

A/Z....  
...A/Z  
...A/Z 1/9  
2700-4816  
VA-10  
FOR: VACHETTE®

FOR: ROVER®

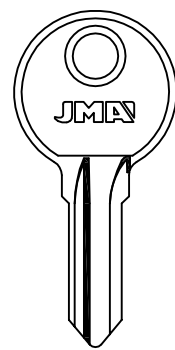

R  
001-224  
LAS-R

V  
001-224  
LAS-V

FOR: LAS®  
FOR: DUBOIS® -KIFERM® -PJ® -PK®

Y  
001-224  
LAS-Y

FOR: ROVER®

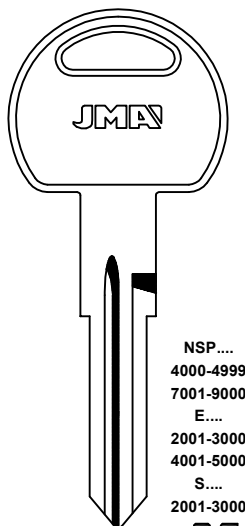

FOR: NEIMAN®

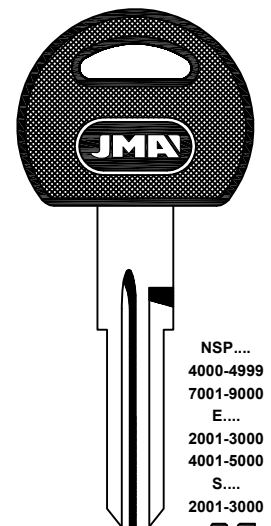

FOR: NEIMAN®

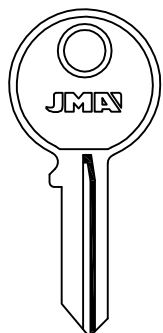

FS...1-99  
FS...876-955  
UN-1FS

NRA  
FFE...1-100  
FJA...1-100  
FL...251-500  
NRA...51-90  
YFB...1-75  
FMD...1-75  
FG...1-30  
NF...1-30  
EJR...1-75  
UN-FFE  
MC...1-40  
MRA...251-290  
MRN...1-54  
MRN...201-250  
MRN...251-300  
UN-MRN  
FA...  
501-625  
UN-44  
FOR: UNION®

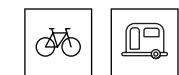

UN-3

FP...  
626-750  
UN-FP

HX...100

UN-2

FR...  
751-875  
UN-FR

RM...

UN-44D

NGN...1-54  
UN-NG

FOR: SCANIA®

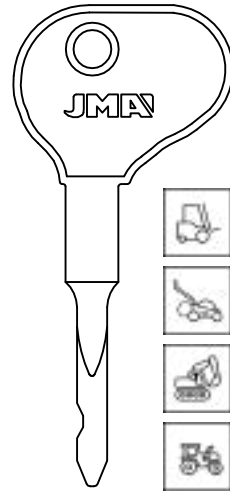

BH-2  
FOR: BOSCH®

FOR: SCANIA®

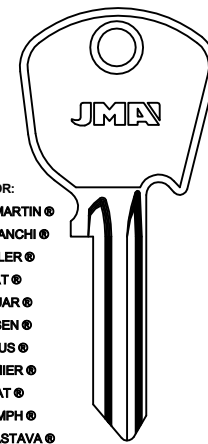

FOR:  
ASTON MARTIN®  
AUTOBIANCHI®  
DAIMLER®  
FIAT®  
JAGUAR®  
JENSEN®  
LOTUS®  
PREMIER®  
SEAT®  
TRIUMPH®  
YUGO ZASTAVA®  
SCANIA®  
FK  
1-3040  
FO-FK  
FOR: FORD®  
FOR: ARMAN® -DOM® -JUGODENT® -WASO®

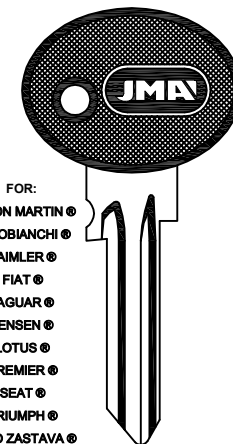

FOR:  
ASTON MARTIN®  
AUTOBIANCHI®  
DAIMLER®  
FIAT®  
JAGUAR®  
JENSEN®  
LOTUS®  
PREMIER®  
SEAT®  
TRIUMPH®  
YUGO ZASTAVA®  
SCANIA®  
FK  
1-3040  
FO-FK.P  
FOR: FORD®

FR  
1-3040  
4001-6000  
FO-FR  
FOR: FORD®

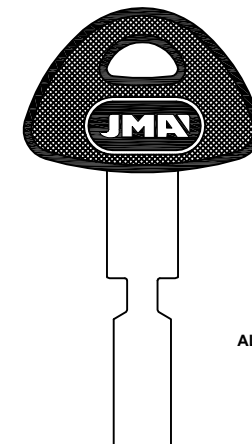

ALP.  
...  
1-2000  
7,6  
3,5  
HU-2.P  
FOR: HUF®

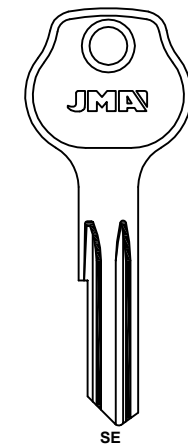

SE  
001-750  
SC  
401-630  
HU-SC

FOR: HUF®  
FOR: AKS®

SR  
001-240  
KSR  
001-240  
LSR  
001-240  
TSR  
001-240  
HU-SR



SZ  
1-240  
HU-SZ

FOR: HUF®  
FOR: AKS®

SU  
001-240  
401-630  
HU-SU

HU-SU

SX  
001-240  
HU-SX

HU-SX

SY  
001-240  
HU-SY

HU-SY

FOR: SCANIA®

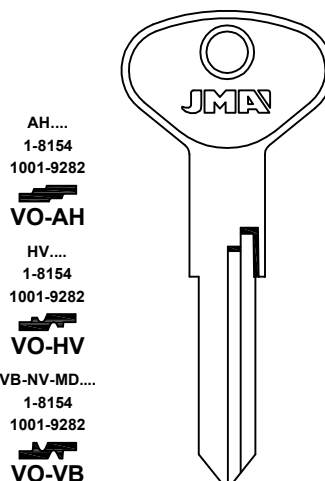

AH...  
1-8154  
1001-9282  
VO-AH

HV...  
1-8154  
1001-9282  
VO-HV

VB-NV-MD...  
1-8154  
1001-9282  
VO-VB

N...  
VO-N



FOR: HUF®  
FOR: AKS® -CASI® -UBE® -WITTE®

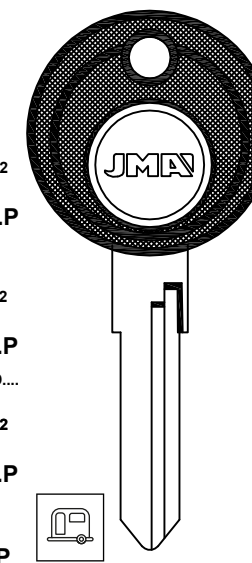

AH...  
1-8154  
1001-9282  
VO-AH.P

HV...  
1-8154  
1001-9282  
VO-HV.P

VB-NV-MD...  
1-8154  
1001-9282  
VO-VB.P

N...  
VO-N.P



FOR: HUF®  
FOR: AKS® -CASI® -UBE® -WITTE®

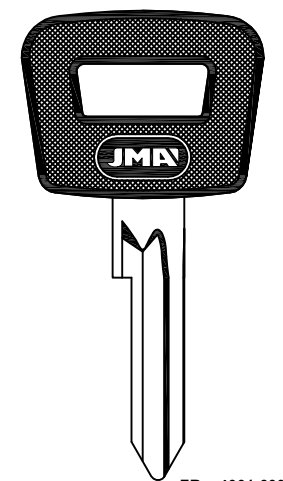

AN...  
001-854  
1001-1918  
2001-2830  
3001-3890  
4001-5151  
6001-7086  
7001-8154  
8201-9282  
AU-AN.P

AU-AN.P

FR...4001-6000  
FZ...1-1232  
WAS-2.P

FOR: WASO®  
FOR: ARMAN® -DOM®

FOR: SCANIA®

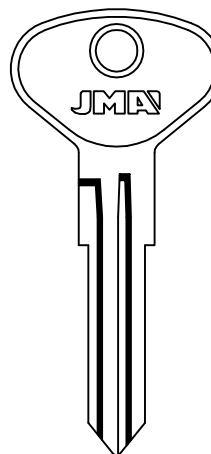

8001-8100  
WIT-1  
FOR: WITTE®

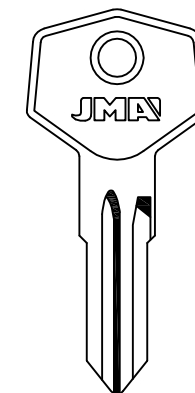

KA  
001-100  
AKS-1  
FOR: AKS®

FOR: STEYR PUCH®

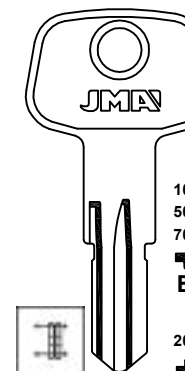

A...  
101-125  
501-598  
701-790  
BL-2

B...  
201-225  
BL-3

A

BL-4

BL-6

FOR: BLAU®

BL-4D

BL-6D

FOR: FORT® -HK® -WASO®

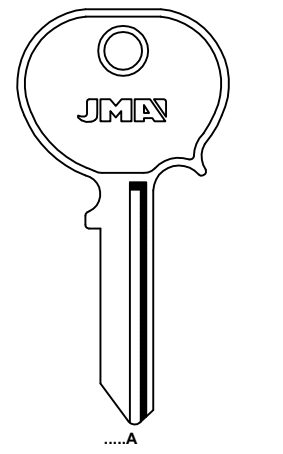

...A  
...D  
...F  
1 AL 5  
NE-25  
FOR: NEIMAN®

Concerning the marks and commercial denominations see legal warning.  
Concerniente a las marcas y denominaciones comerciales ver aviso legal.  
Marka eta izendapen komertzialiei dagokienez, ikus lege-oharra.  
Concernant les marques et denominations commerciales voir la note dans l'index.

FOR: STEYR PUCH®

FOR: TATA®

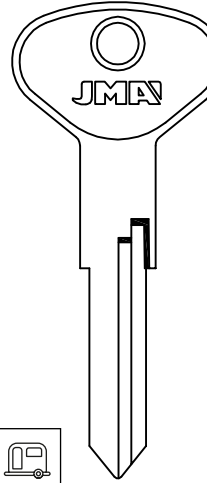

AH....  
1-8154  
1001-9282

**VO-AH**

HV....  
1-8154  
1001-9282

**VO-HV**

VB-NV-MD....  
1-8154  
1001-9282

**VO-VB**

N....  
**VO-N**

FOR: HUF®  
FOR: AKS® - CASI® - UBE® - WITTE®

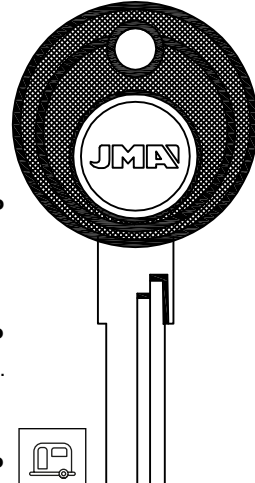

AH....  
1-8154  
1001-9282

**VO-AH.P**

HV....  
1-8154  
1001-9282

**VO-HV.P**

VB-NV-MD....  
1-8154  
1001-9282

**VO-VB.P**

N....  
**VO-N.P**

AN....  
001-854  
1001-1918  
2001-2830  
3001-3890  
4001-5151  
6001-7086  
7001-8154  
8201-9282

**AU-AN**

FOR: HUF®  
FOR: AKS® - CASI® - UBE® - WITTE®

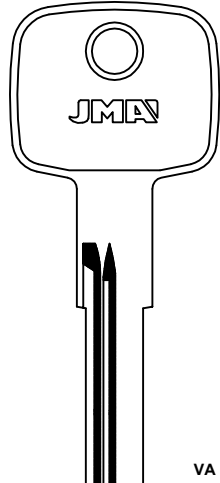

VA  
01-50  
**ME-VA**

FOR: HUF®  
FOR: CASI®

FOR: TRUCK (USA)®

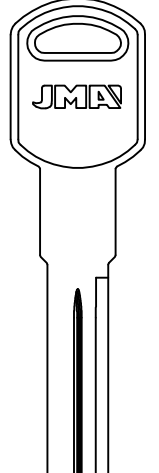

....A00-7N45  
**GM-14**

FOR: G.M.®  
FOR: BRIGGS STRATTON®

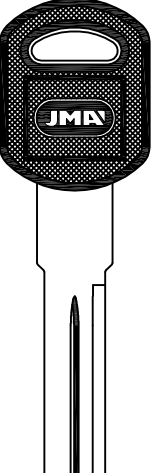

....A00-7N45  
**GM-14.P**

FOR: G.M.®  
FOR: BRIGGS STRATTON®

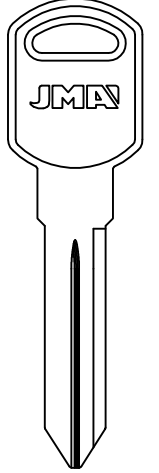

....A00-7N45  
**GM-25**

FOR: G.M.®  
FOR: BRIGGS STRATTON®

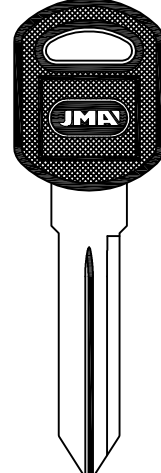

....A00-7N45  
**GM-25.P**

FOR: G.M.®  
FOR: BRIGGS STRATTON®

FOR: VOLKSWAGEN®

FOR: VOLVO®

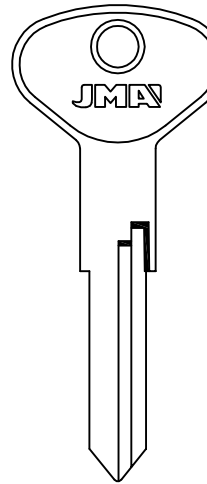

AH....  
1-8154  
1001-9282

**VO-AH**

HV....  
1-8154  
1001-9282

**VO-HV**

VB-NV-MD....  
1-8154  
1001-9282

**VO-VB**

N....  
**VO-N**

FOR: HUF®  
FOR: AKS® - CASI® - UBE® - WITTE®

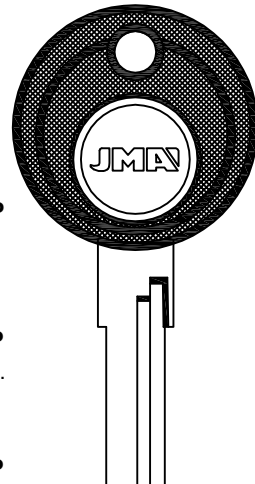

AH....  
1-8154  
1001-9282

**VO-AH.P**

HV....  
1-8154  
1001-9282

**VO-HV.P**

VB-NV-MD....  
1-8154  
1001-9282

**VO-VB.P**

N....  
**VO-N.P**

AN....  
001-854  
1001-1918  
2001-2830  
3001-3890  
4001-5151  
6001-7086  
7001-8154  
8201-9282

**AU-AN**

FOR: HUF®  
FOR: AKS® - CASI® - UBE® - WITTE®

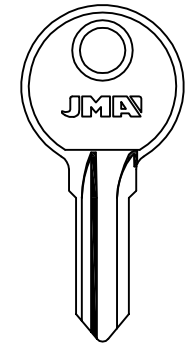

R  
001-224  
**LAS-R**

V  
001-224  
**LAS-V**

Y  
001-224  
**LAS-Y**

FOR: LAS®  
FOR: DUBOIS® - KIFERM® - PJ® - PK®

FOR: VOLVO®

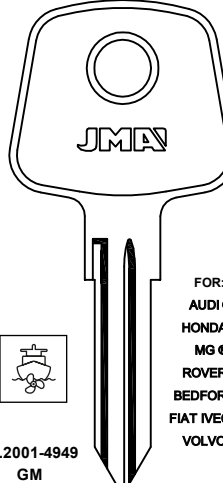

FOR: AUDI®  
HONDA®  
MG®  
ROVER®  
BEDFORD®  
FIAT (VECO)®  
VOLVO®

....2001-4949  
GM®  
....2001-3000

**NE-1**

FOR: NEIMAN®  
FOR: CLAUSOR®

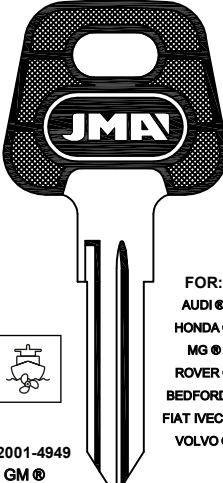

FOR: AUDI®  
HONDA®  
MG®  
ROVER®  
BEDFORD®  
FIAT (VECO)®  
VOLVO®

....2001-4949  
GM®  
....2001-3000

**NE-1.D**

FOR: NEIMAN®  
FOR: CLAUSOR®

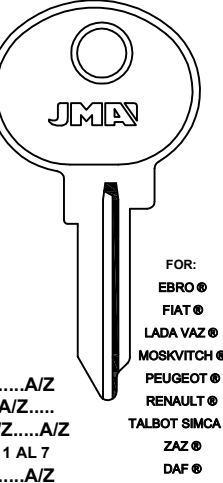

FOR: EBRO®  
FIAT®  
LADA VAZ®  
MOSKVITCH®  
PEUGEOT®  
RENAULT®  
TALBOT SIMCA®  
ZAZ®  
DAF®  
VOLVO®

....A/Z  
A/Z.....  
A/Z.....A/Z  
1 AL 7  
....A/Z  
0 AL 9

**NE-3**

FOR: NEIMAN®  
FOR: CLAUSOR®

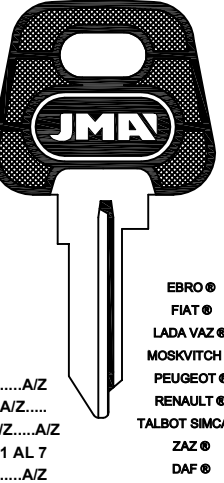

FOR: EBRO®  
FIAT®  
LADA VAZ®  
MOSKVITCH®  
PEUGEOT®  
RENAULT®  
TALBOT SIMCA®  
ZAZ®  
DAF®  
VOLVO®

....A/Z  
A/Z.....  
A/Z.....A/Z  
1 AL 7  
....A/Z  
0 AL 9

**NE-3.P**

FOR: NEIMAN®  
FOR: CLAUSOR®

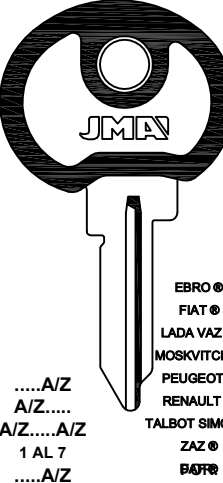

FOR: EBRO®  
FIAT®  
LADA VAZ®  
MOSKVITCH®  
PEUGEOT®  
RENAULT®  
TALBOT SIMCA®  
ZAZ®  
DAF®  
VOLVO®

....A/Z  
A/Z.....  
A/Z.....A/Z  
1 AL 7  
....A/Z  
0 AL 9

**NE-3.P2**

FOR: NEIMAN®  
FOR: CLAUSOR®

FOR: VOLVO®

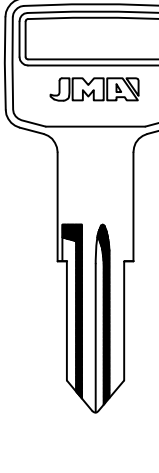

....6250-6499  
**NE-9**

FOR: NEIMAN®  
FOR: CLAUSOR®

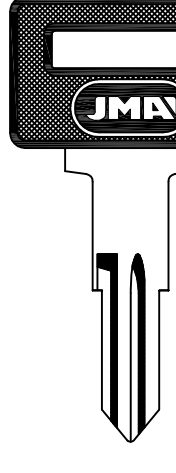

....6250-6499  
**NE-9.P**

FOR: NEIMAN®  
CLAUSOR®

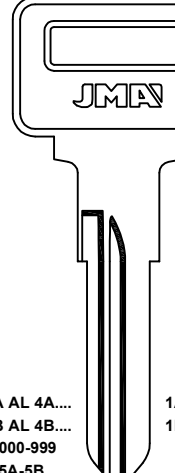

1A AL 4A....  
1B AL 4B....  
000-999  
5A-5B...  
000-746

**NE-12**

FOR: NEIMAN®



1A AL 4A....  
1B AL 4B....  
000-999  
5A-5B...  
000-746

**NE-18**

FOR: NEIMAN®

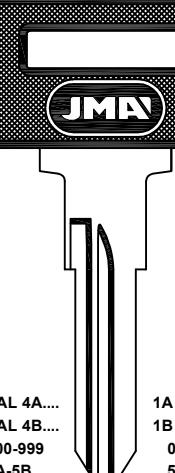

1A AL 4A....  
1B AL 4B....  
000-999  
5A-5B...  
000-746

**NE-12.P**

FOR: NEIMAN®



1A AL 4A....  
1B AL 4B....  
000-999  
5A-5B...  
000-746

**NE-18.P**

FOR: NEIMAN®

FOR: VOLVO®

FOR: WHITE®

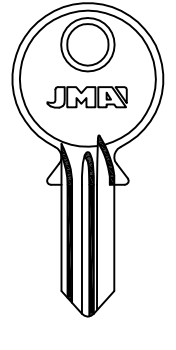

A8..AA-DS  
..8AB-ZZ  
S...385-402

**RO-1I**

FOR: ABSA® - FROSER® - PJ® - SADV®

..4AB-ZZ  
S...331-348

**RO-2I**

AA-JZ  
A4..A.A.  
**RO-4I**

AB-ZZ  
..6  
S...349-366

**RO-6I**

FOR: RONIS®

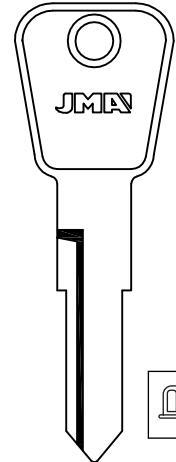

..3AB-ZZ  
...1 AL 4

**RO-2D**

AA-JZ  
A3..A.3.  
S...213-246

**RO-4D**

AB-ZZ  
..7  
S...367-384

**RO-6D**

W...  
600-842

**WAS-1**

FOR: WASO®

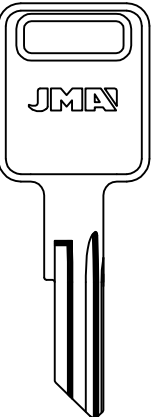

LAT.

**AMM-1**

FOR: AMERICAN MOT.®

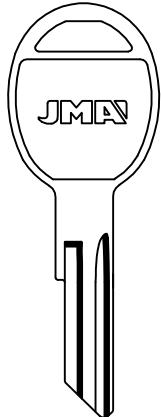

LAT.

**AMM-2**

FOR: AMERICAN MOT.®

Concerning the marks and commercial denominations see legal warning.  
Concerniente a las marcas y denominaciones comerciales ver aviso legal.  
Marka eta izendapen komertzialiei dagokienez, ikus lege-oharra.  
Concernant les marques et denominations commerciales voir la note dans l'index.

**JMA** Opening the future

**JMA** Opening the future

Beziehen auf die Marke und Handelsname sehen sie die Notiz im Impressum.  
Relativamente às marcas e denominações comerciais, ver aviso legal.  
Jeśli chodzi o znaki i nazwy handlowe, patrz Informacje prawne.

FOR: WHITE®

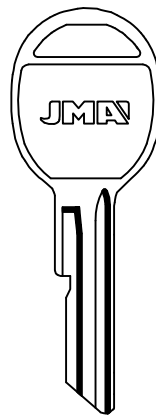

E...225-814  
L...1-1000  
**BS-2**  
FOR: B & S®

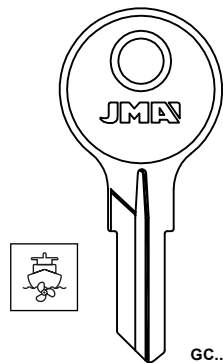

A...250-1500  
AP...250-1500  
B...250-1500  
C...1251-1700  
CB...250-1500  
DC-EP...250-699  
P...250-1500  
**BS-6**  
FOR: B & S®

LAT.

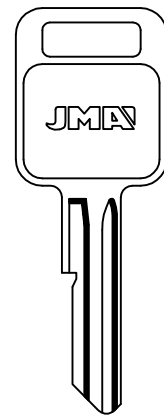

D  
225-814  
K  
01-1000  
**BS-5**  
FOR: B & S®  
FOR: POLLAK® - BOBCAT®

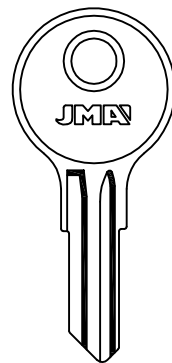

A...201-1050  
C...500-699  
H...601-1100  
HM...201-1050  
**HUD-1**  
FOR: HUDSON®



FOR: APRILIA®

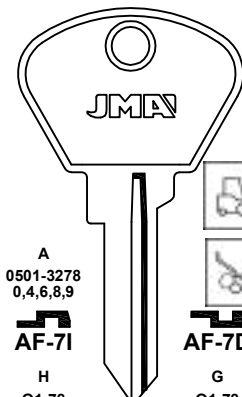

A  
0501-3278  
0,4,6,8,9  
**AF-71**

H  
01-78  
**AF-81**

F  
01-78  
**AF-91**

FOR: SIPEA®  
FOR: SAFE®

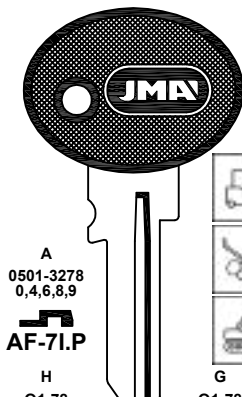

A  
0501-3278  
0,4,6,8,9  
**AF-71.P**

H  
01-78  
**AF-81.P**

F  
01-78  
**AF-91.P**

FOR: SIPEA®  
FOR: SAFE®

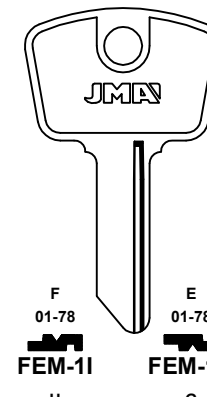

F  
01-78  
**FEM-11**

H  
01-78  
**FEM-21**

F  
01-78  
**FEM-31**

FOR: FEMSA®

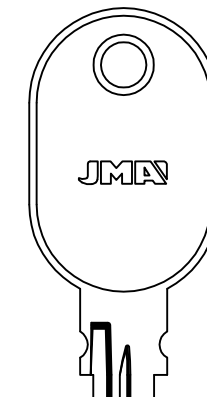

N 6001-7000  
J 3001-6732  
V 0001-3051  
V 5001-8058  
AB 6001-6891  
**FI-11**

FOR: GIOBERT®  
FOR: RAYTON FISSORE® - STEYR PUCH® - APRILIA®



N 6001-7000  
J 3001-6732  
V 0001-3051  
V 5001-8058  
AB 6001-6891  
**FI-11.P**

FOR: GIOBERT®

FOR: APRILIA®

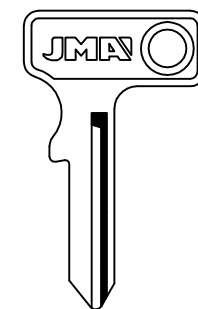

.0.../...0...  
...0/0...0  
AA.../BA...  
CA...  
1 AL 5  
**NE-8**

FOR: NEIMAN®  
FOR: CLAUSOR®

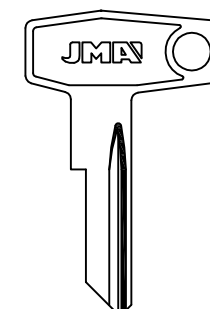

...1-1625  
...5001-6278  
E...1-710  
**ZA-1**

FOR: ZADI®  
FOR: BRETER®

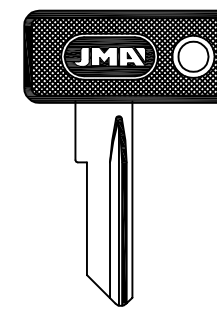

...1-1625  
...5001-6278  
E...1-710  
**ZA-1.P**

FOR: ZADI®  
FOR: BRETER®

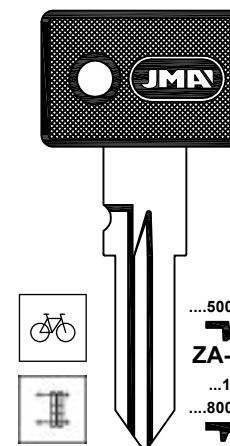

...5001-6475  
**ZA-13.P**  
...1-700  
...8001-9554  
**ZA-4D.P**  
...2001-3554  
...8001-9554  
**ZA-2.P**

FOR: ZADI®  
FOR: BASTA® - VIRO® - LML®

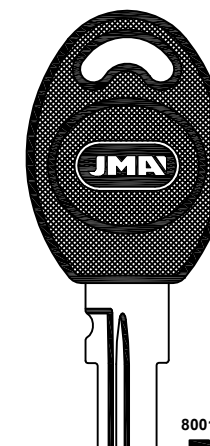

8001-9554  
**ZA-9.P2**  
8001-9554  
**ZA-6D.P1**

FOR: ZADI®

FOR: APRILIA®

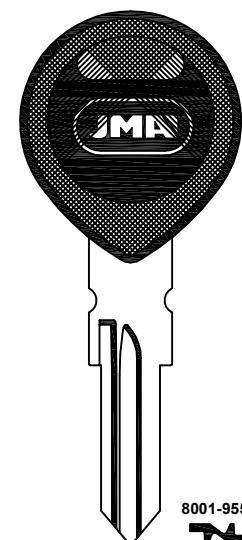

8001-9554  
**ZA-9.P1**

FOR: ZADI®

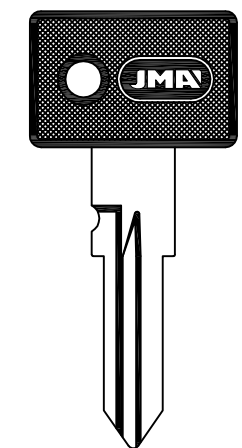

...5001-6475  
**ZA-13.P**

FOR: ZADI®  
FOR: LML®

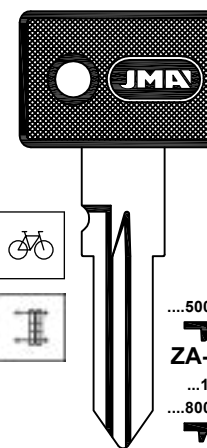

...5001-6475  
**ZA-13.P**  
...1-700  
...8001-9554  
**ZA-4D.P**  
...2001-3554  
...8001-9554  
**ZA-2.P**

FOR: ZADI®  
FOR: BASTA® - VIRO® - LML®

FOR: ATALA®

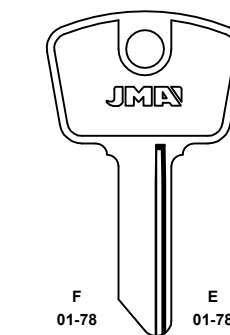

F  
01-78  
**FEM-11**

H  
01-78  
**FEM-21**

F  
01-78  
**FEM-31**

FOR: FEMSA®

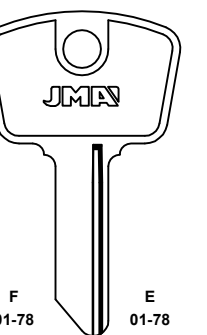

E  
01-78  
**FEM-1D**

G  
01-78  
**FEM-2D**

F  
01-78  
**FEM-3D**

FOR: FEMSA®

FOR: BENELLI®

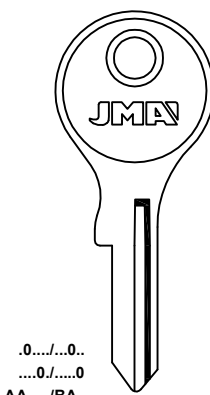

.0.../...0...  
...0/0...0  
AA.../BA...  
CA.../EA...  
Z.../Z...  
...Z.../Z...  
...Z.../Z...  
1 AL 5  
**NE-6**

FOR: NEIMAN®

Concerning the marks and commercial denominations see legal warning.  
Concerniente a las marcas y denominaciones comerciales ver aviso legal.  
Marka eta izendapen komertzialiei dagokienez, ikus lege-oharra.  
Concernant les marques et denominations commerciales voir la note dans l'index.

**JMA** Opening the future

**JMA** Opening the future

Beziehen auf die marke und handelsname sehen sie die notiz im Impressum.  
Relativamente às marcas e denominações comerciais, ver aviso legal.  
Jeśli chodzi o znaki i nazwy handlowe, patrz Informacje prawne.

**K04** / 317



FOR: BENELLI®

.0.../...0...  
 ...0.../...0...  
 AA.../BA...  
 CA.../EA...  
 Z.../Z...  
 ..Z.../Z...  
 ...Z.../...Z...  
 1 AL 5  
**NE-6.P**  
 FOR: NEIMAN®

.0.../...0...  
 ...0.../...0...  
 AA.../BA...  
 CA...  
 1 AL 5  
**NE-8**  
 FOR: NEIMAN®  
 FOR: CLAUSOR®

...1-1625  
 ...5001-6278  
 E...1-710  
**ZA-1**  
 FOR: ZADI®  
 FOR: BRETER®

...1-1625  
 ...5001-6278  
 E...1-710  
**ZA-1.P**  
 FOR: ZADI®  
 FOR: BRETER®

FOR: BETA®

FOR:  
 CROMODORA®  
 FIST®  
 FREA®  
 GIOBERT®  
 MIRAGLIO®  
 RUFFINI®

6  
 100-309  
**AF-5I**  
 2  
 100-309  
**AF-6I**

8  
 100-309  
**AF-5D**  
 4  
 100-309  
**AF-6D**  
 FOR: SAFE®

FOR: BICICLETTA-CYCLES®

NRA  
 FFE...1-100  
 FJA...1-100  
 FL...251-500  
 NRA...51-90  
 YFB...1-75  
 FMD...1-75  
 FG...1-30  
 NF...1-30  
 EJR...1-75  
**UN-FFE**  
 MC...1-40  
 MRA...251-290  
 MRN...1-54  
 MRN...201-250  
 MRN...251-300  
**UN-MRN**  
 FA...  
 501-625  
**UN-44**  
 FOR: UNION®

FP...  
 626-750  
**UN-FP**  
 FR...  
 751-875  
**UN-FR**  
 RM...  
 911-952  
**UN-44D**  
 NGN...1-54  
**UN-NG**

95001-97000  
 97001-99000  
**LF-2**  
**LF-12**  
 FOR: L. & F.®  
 FOR: DOBLE SAFE® -EURO LOCKS®

FS...1-99  
 FS...876-955  
**UN-1FS**

HX...100  
**UN-3**  
**UN-2**

FOR: BIMOTA®

6  
 100-517  
**FAR-1I**

8  
 100-517  
**FAR-1D**

2  
 100-517  
**FAR-2I**

4  
 100-517  
**FAR-2D**

H  
 100-309  
**FAR-3**

**FAR-3D**

**FAR-4D**  
 FOR: FARMA®  
 FOR: FISAM®

FOR: BETA®

...5001-6475  
**ZA-13.P**  
 ...1-700  
 ...8001-9554  
**ZA-4D.P**  
 ...2001-3554  
 ...8001-9554  
**ZA-2.P**  
 8001-9554  
**ZA-9.P2**  
 8001-9554  
**ZA-6D.P1**  
 FOR: ZADI®

2  
 100-309  
**FAB-1**  
 FOR: FAAB®

...1-1625  
 ...5001-6278  
 E...1-710  
**ZA-1**  
 FOR: ZADI®  
 FOR: BRETER®

...1-1625  
 ...5001-6278  
 E...1-710  
**ZA-1.P**  
 FOR: ZADI®  
 FOR: BRETER®

...5001-6475  
**ZA-13.P**  
 ...1-700  
 ...8001-9554  
**ZA-4D.P**  
 ...2001-3554  
 ...8001-9554  
**ZA-2.P**  
 8001-9554  
**ZA-9.P2**  
 8001-9554  
**ZA-6D.P1**  
 FOR: ZADI®  
 FOR: BASTA® -VIRO® -LML®

FOR: BIMOTA®

...  
 101-499  
 751-795  
 A00-A99  
**SUZU-4I**  
 FOR: SUZUKI®

...  
 101-499  
 751-795  
 A00-A99  
**SUZU-4D**  
 FOR: SUZUKI®

...  
 101-499  
 751-795  
 A00-A99  
**SUZU-4I.P**  
 FOR: SUZUKI®

...  
 101-499  
 751-795  
 A00-A99  
**SUZU-4D.P**  
 FOR: SUZUKI®

...  
 101-499  
 751-795  
**SUZU-5**  
 FOR: SUZUKI®

FOR: LAVERDA® -AUGUSTA® -PEUGEOT® -SUZUKI®

FOR: BETA®

8001-9554  
**ZA-9.P1**  
 FOR: ZADI®

FOR: BICICLETTA-CYCLES®

7000-7999  
 A...  
 7000-7999  
**AS-2I**

8000-9999  
 A...  
 9000-9999  
**AS-21D**

7000-7999  
 A...  
 7000-7999  
**AS-21.P**

8000-9999  
 A...  
 9000-9999  
**AS-21D.P**  
 FOR: ASSA®

21...  
 0001-9999  
**AS-17D**  
 FOR: ASSA®

7000-7999  
 A...  
 7000-7999  
**AS-2I**

6000-8999  
 A...  
 9000-9999  
**AS-2D**  
 FOR: ASSA®

FOR: BIMOTA®

101-499  
 751-795  
 A00-A99  
**SUZU-5.P**  
 FOR: SUZUKI®

...  
 101-499  
 751-795  
 A00-A99  
**SUZU-13D.P**  
 FOR: SUZUKI®  
 FOR: LAVERDA® -AUGUSTA® -PEUGEOT® -SUZUKI®

...1-1625  
 ...5001-6278  
 E...1-710  
**ZA-1**  
 FOR: ZADI®  
 FOR: BRETER®

...1-1625  
 ...5001-6278  
 E...1-710  
**ZA-1.P**  
 FOR: ZADI®  
 FOR: BRETER®

FOR: BMA®

A  
 0501-3278  
 0,4,6,8,9  
**AF-7I**

G  
 01-78  
**AF-7D**

H  
 01-78  
**AF-8I**

G  
 01-78  
**AF-8D**

F  
 01-78  
**AF-9I**

E  
 01-78  
**AF-9D**  
 FOR: SIPEA®  
 FOR: SAFE®

Concerning the marks and commercial denominations see legal warning.  
 Concerniente a las marcas y denominaciones comerciales ver aviso legal.  
 Marka eta izendapen komertzialiei dagokienez, ikus lege-oharra.  
 Concernant les marques et denominations commerciales voir la note dans l'index.

FOR: BMA®

A  
0501-3278  
0,4,6,8,9  
AF-7I.P  
H  
01-78  
AF-8I.P  
F  
01-78  
AF-9I.P  
FOR: SIPEA®  
FOR: SAFE®

F  
01-78  
FEM-1I  
H  
01-78  
FEM-2I  
F  
01-78  
FEM-3I  
FOR: FEMSA®

E  
01-78  
FEM-1D  
G  
01-78  
FEM-2D  
E  
01-78  
FEM-3D  
FOR: FEMSA®

NRA  
FFE...1-100  
FJA...1-100  
FL...251-500  
NRA...51-90  
YFB...1-75  
FMD...1-75  
FG...1-30  
NF...1-30  
EJR...1-75  
UN-FFE  
UN-3  
UN-FP  
MC...1-40  
MRA...251-290  
MRN...1-54  
MRN...201-250  
MRN...251-300  
UN-MRN  
FA...  
501-625  
UN-44  
UN-44D  
FOR: UNION®

FP...  
626-750  
UN-FP  
FR...  
751-875  
UN-FR  
HX...100  
UN-2  
RM...  
911-952  
UN-44D  
NGN...1-54  
UN-NG

FOR: BMW®

A...  
101-125  
501-598  
701-790  
BL-2  
B...  
201-225  
BL-3  
A  
BL-4  
A 201-225  
BL-6  
FOR: BLAU®  
FOR: FORT® -HK® -WASO®

B...  
201-225  
BL-3  
B 101-125  
BL-4D  
BL-6D

FOR: CAGIVA®

J  
3001-6732  
N  
6001-7000  
FI-1  
J  
3001-6732  
N  
6001-7000  
FI-10  
FOR: GIOBERT®

J  
3001-6732  
N  
6001-7000  
FI-1.P  
J  
3001-6732  
N  
6001-7000  
FI-10.P  
FOR: GIOBERT®

FOR:  
ALFA ROMEO®  
AUTOSIANCHI®  
CITROEN®  
FERRARI®  
FIAT®  
INNOCENTI®  
LANCIA®  
PEUGEOT®  
YUGO ZASTAVA  
CAGIVA®  
DUCATI®  
FANTIC MOTOR®  
GARELLI®  
GILERA®

K 3301-4886  
K 7001-8092  
T 5000-6027  
T 7001-8092  
S 0501-3278  
H 7001-8092  
FI-6I  
FOR: GIOBERT®

FOR:  
FERRARI®  
FIAT®  
CAGIVA®

K 3301-4886  
K 7001-8092  
T 5000-6027  
T 7001-8092  
S 0501-3278  
H 7001-8092  
FI-6I.P2  
FOR: GIOBERT®

FOR:  
AUTOSIANCHI®  
CITROEN®  
FERRARI®  
FIAT®  
LANCIA®  
PEUGEOT®  
YUGO ZASTAVA  
CAGIVA®  
DUCATI®  
FANTIC MOTOR®  
GARELLI®  
GILERA®

K 3301-4886  
K 7001-8092  
T 5000-6027  
T 7001-8092  
S 0501-3278  
H 7001-8092  
FI-6I.P3  
FOR: GIOBERT®

FOR: BMW®

H...P  
12353-53425  
BM-HB.P1  
FOR: HUF®  
FOR: NEIMAN®

...0.../...0...  
...0.../...0...  
AA.../BA...  
CA.../EA...  
Z.../Z...  
...Z.../...Z...  
...Z.../...Z...  
1 AL 5  
NE-6  
FOR: NEIMAN®

...0.../...0...  
...0.../...0...  
AA.../BA...  
CA.../EA...  
Z.../Z...  
...Z.../...Z...  
...Z.../...Z...  
1 AL 5  
NE-6.P  
FOR: NEIMAN®

...O/H...  
...H.../...H...  
...H.../...H...  
1 AL 5  
NE-7  
FOR: NEIMAN®

8001-9554  
ZA-7D.P1  
8001-9554  
ZA-6D.P  
FOR: ZADI®

FOR: CAGIVA®

LAT.  
FIS-1D  
FOR: FIST®

B... 1 AL 4  
H... 1 AL 4  
KAW-6.P  
KAW-6D.P  
FOR: KAWASAKI®

1001-1500  
MER-16  
MER-16D  
FOR: MERONI®  
FOR: LAMA®

...  
101-499  
751-795  
A00-A99  
SUZU-4I  
SUZU-4D  
FOR: SUZUKI®

...  
101-499  
751-795  
A00-A99  
SUZU-4I.P  
SUZU-4D.P  
FOR: SUZUKI®  
FOR: LAVERDA® -AUGUSTA® -PEUGEOT® -SUZUKI®

FOR: BUELL®

8001-9554  
ZA-9.P1  
FOR: ZADI®

FOR: CAGIVA®

K.3301-4886  
K.7001-8092  
T.5000-6027  
T.7001-8092  
S.0501-3278  
H.7001-8092  
K-H  
7001-8092  
AF-14.P  
FOR: GIOBERT®

FI-6I.P4  
FOR: GIOBERT®

CL-2I  
CL-2D  
CL-3I  
FOR: CLAUSOR®

F  
01-78  
FEM-1I  
H  
01-78  
FEM-2I  
E  
01-78  
FEM-1D  
G  
01-78  
FEM-2D  
FEM-3I  
FEM-3D  
FOR: FEMSA®

FOR: CAGIVA®

...  
101-499  
751-795  
A00-A99  
SUZU-13.P  
SUZU-13D.P  
FOR: SUZUKI®

...1-1625  
...5001-6278  
E...1-710  
ZA-1  
FOR: ZADI®  
FOR: BRETER®

...1-1625  
...5001-6278  
E...1-710  
ZA-1.P  
FOR: ZADI®  
FOR: BRETER®

...5001-6475  
ZA-13.P  
...1-700  
...8001-9554  
ZA-4D.P  
...2001-3554  
...8001-9554  
ZA-2.P  
FOR: ZADI®  
FOR: BASTA® -VIRO® -JML®

ZA-8.P  
FOR: ZADI®

Concerning the marks and commercial denominations see legal warning.  
Conceniende a las marcas y denominaciones comerciales ver aviso legal.  
Marka eta izendapen komertzialiei dagokienez, ikus lege-oharra.  
Concernant les marques et denominations commerciales voir la note dans l'index.



FOR: CIMATTI®

2  
100-309  
**FAB-1**  
FOR: FAAB®

1-1625  
5001-6278  
E...1-710  
**ZA-1**  
FOR: ZADI®  
FOR: BRETER®

1-1625  
5001-6278  
E...1-710  
**ZA-1.P**  
FOR: ZADI®  
FOR: BRETER®

FOR: DEMM®

.0.../...0...  
...0.../...0  
AA.../BA...  
CA.../EA...  
Z.../Z...  
...Z.../...Z...  
...Z.../...Z...  
1 AL 5  
**NE-6**  
FOR: NEIMAN®

.0.../...0...  
...0.../...0  
AA.../BA...  
CA.../EA...  
Z.../Z...  
...Z.../...Z...  
...Z.../...Z...  
1 AL 5  
**NE-6.P**  
FOR: NEIMAN®

FOR: DUCATI®

FOR:  
AUTOBIANCHI®  
CITROEN®  
FERRARI®  
FIAT®  
LANCIA®  
PEUGEOT®  
YUGO ZASTAVA  
CAGIVA®  
DUCATI®  
FANTIC MOTOR®  
GARELLI®  
GILERA®

K 3301-4886  
K 7001-8092  
T 5000-6027  
T 7001-8092  
S 0501-3278  
H 7001-8092  
**FI-6I.P3**  
FOR: GIOBERT®

B. 1 AL 4  
H. 1 AL 4  
**KAW-6.P**  
FOR: KAWASAKI®

**KAW-6D.P**  
FOR: KAWASAKI®

1 AL 5  
**NE-6**  
FOR: NEIMAN®

.0.../...0...  
...0.../...0  
AA.../BA...  
CA.../EA...  
Z.../Z...  
...Z.../...Z...  
...Z.../...Z...  
1 AL 5  
**NE-6.P**  
FOR: NEIMAN®

.0.../...0...  
...0.../...0  
AA.../BA...  
CA...  
1 AL 5  
**NE-8**  
FOR: NEIMAN®  
FOR: CLAUSOR®

FOR: DERBY®

8001-9554  
**ZA-9.P1**  
FOR: ZADI®

FOR: DKM-HERCULES®

.0.../...0...  
...0.../...0  
AA.../BA...  
CA.../EA...  
Z.../Z...  
...Z.../...Z...  
...Z.../...Z...  
1 AL 5  
**NE-6**  
FOR: NEIMAN®

.0.../...0...  
...0.../...0  
AA.../BA...  
CA.../EA...  
Z.../Z...  
...Z.../...Z...  
...Z.../...Z...  
1 AL 5  
**NE-6.P**  
FOR: NEIMAN®

FOR: DUCATI®

K.3301-4886  
K.7001-8092  
T.5000-6027  
T.7001-8092  
S.0501-3278  
H.7001-8092  
K-H  
7001-8092  
**AF-14.P**  
FOR: GIOBERT®  
**FI-6I.P4**  
FOR: GIOBERT®

FOR: FIST® -M.MARELLI® -NEIMAN® -SIPEA®

FOR: DUCATI®

1-1625  
5001-6278  
E...1-710  
**ZA-1**  
FOR: ZADI®  
FOR: BRETER®

1-1625  
5001-6278  
E...1-710  
**ZA-1.P**  
FOR: ZADI®  
FOR: BRETER®

5001-6475  
1-700  
8001-9554  
**ZA-4D.P**  
2001-3554  
8001-9554  
**ZA-2.P**  
FOR: ZADI®  
FOR: BASTA® -VIRO® -LML®

5001-6475  
**ZA-13.P**  
FOR: ZADI®  
FOR: LML®

FOR: FANTIC MOTOR®

K.3301-4886  
K.7001-8092  
T.5000-6027  
T.7001-8092  
S.0501-3278  
H.7001-8092  
K-H  
7001-8092  
**AF-14.P**  
FOR: GIOBERT®  
**FI-6I.P4**  
FOR: GIOBERT®

FOR: FIST® -M.MARELLI® -NEIMAN® -SIPEA®

FOR: DUCATI®

6  
100-517  
**FAR-1**

8  
100-517  
**FAR-1D**

2  
100-517  
**FAR-2**

4  
100-517  
**FAR-2D**

H  
100-309  
**FAR-3**

**FAR-3D**

F  
01-78  
**FEM-1**

E  
01-78  
**FEM-1D**

H  
01-78  
**FEM-2**

G  
01-78  
**FEM-2D**

FEM-3I  
FEM-3D  
FOR: FEMSA®

K 3301-4886  
K 7001-8092  
T 5000-6027  
T 7001-8092  
S 0501-3278  
H 7001-8092  
**FI-6I**  
FOR: GIOBERT®

FOR:  
ALFA ROMEO®  
AUTOBIANCHI®  
CITROEN®  
FERRARI®  
FIAT®  
INNOCENTI®  
LANCIA®  
PEUGEOT®  
YUGO ZASTAVA  
CAGIVA®  
DUCATI®  
FANTIC MOTOR®  
GARELLI®  
GILERA®

K 3301-4886  
K 7001-8092  
T 5000-6027  
T 7001-8092  
S 0501-3278  
H 7001-8092  
**FI-6I.P2**  
FOR: GIOBERT®

FERRARI®  
FIAT®  
CAGIVA®

FOR: FANTIC MOTOR®

FOR:  
ALFA ROMEO®  
AUTOBIANCHI®  
CITROEN®  
FERRARI®  
FIAT®  
INNOCENTI®  
LANCIA®  
PEUGEOT®  
YUGO ZASTAVA  
CAGIVA®  
DUCATI®  
FANTIC MOTOR®  
GARELLI®  
GILERA®

K 3301-4886  
K 7001-8092  
T 5000-6027  
T 7001-8092  
S 0501-3278  
H 7001-8092  
**FI-6I**  
FOR: GIOBERT®

K 3301-4886  
K 7001-8092  
T 5000-6027  
T 7001-8092  
S 0501-3278  
H 7001-8092  
**FI-6I.P2**  
FOR: GIOBERT®

FOR:  
FERRARI®  
FIAT®  
CAGIVA®

**FI-6I.P3**  
FOR: GIOBERT®

FOR:  
AUTOBIANCHI®  
CITROEN®  
FERRARI®  
FIAT®  
LANCIA®  
PEUGEOT®  
YUGO ZASTAVA  
CAGIVA®  
DUCATI®  
FANTIC MOTOR®  
GARELLI®  
GILERA®

3  
0501-1000  
**IMS-3**

4  
0501-1000  
**AF-21**

3  
0501-1000  
**IMS-3.P**

4  
0501-1000  
**AF-21.P**

1  
0501-1000  
**IMS-5**

2  
0501-1000  
**AF-19**

1  
0501-1000  
**IMS-5.P**

2  
0501-1000  
**AF-19.P**

**IMS-13**  
FOR: SAFE®  
FOR: CROMODORA® -FIST® -IMSA®

**IMS-13.P**  
FOR: SAFE®  
FOR: CROMODORA® -FIST® -IMSA®

Concerning the marks and commercial denominations see legal warning.  
Concerniente a las marcas y denominaciones comerciales ver aviso legal.  
Marka eta izendapen komertzialiez dagokienez, ikus lege-oharra.  
Concernant les marques et dénominations commerciales voir la note dans l'index.





FOR: GILERA®

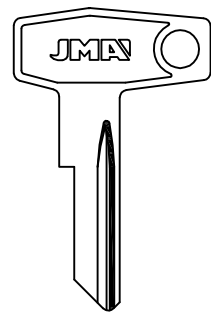

.....1-1625  
.....5001-6278  
E...1-710

**ZA-1**  
FOR: ZADI®  
FOR: BRETER®

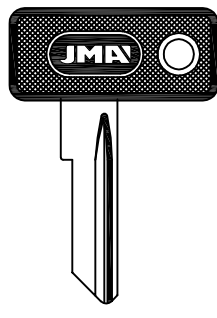

.....1-1625  
.....5001-6278  
E...1-710

**ZA-1.P**  
FOR: ZADI®  
FOR: BRETER®

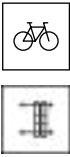
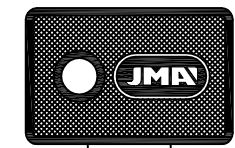

.....5001-6475  
**ZA-13.P**  
...1-700  
.....8001-9554  
**ZA-4D.P**  
.....2001-3554  
.....8001-9554  
**ZA-2.P**

FOR: ZADI®  
FOR: BASTA® -VIRO® -LML®



8001-9554  
**ZA-7D.P1**  
8001-9554  
**ZA-6D.P**

FOR: ZADI®



.....  
8001-9554  
**ZA-7D.P1**

FOR: ZADI®

FOR: HM®

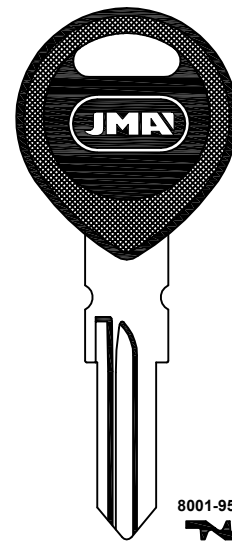

8001-9554  
**ZA-9.P1**

FOR: ZADI®

FOR:  
CROMODORA®  
FIST®  
FREA®  
GIOBERT®  
MIRAGLIO®  
RUFFINI®



6  
100-309  
**AF-5I**  
2  
100-309  
**AF-6I**

FOR: SAFE®



8  
100-309  
**AF-5D**  
4  
100-309  
**AF-6D**

FOR: SAFE®

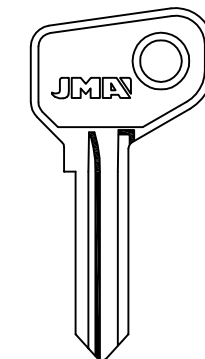

2  
100-309  
**FAB-1**

FOR: FAAB®

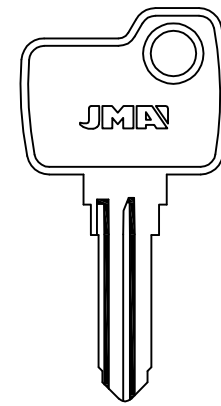

6  
100-517  
**FAR-1I**  
2  
100-517  
**FAR-2I**  
H  
100-309  
**FAR-3**

FOR: FARMA®  
FOR: FISAM®

8  
100-517  
**FAR-1D**  
4  
100-517  
**FAR-2D**  
**FAR-3D**  
**FAR-4D**

FOR: FARMA®  
FOR: FISAM®

FOR: GILERA®

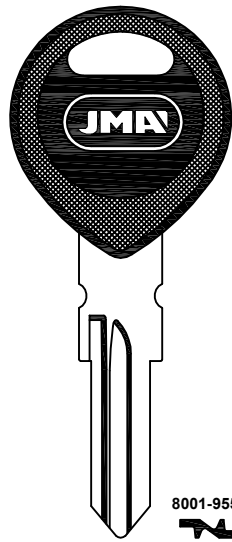

8001-9554  
**ZA-9.P1**  
FOR: ZADI®

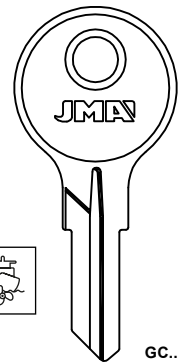

LAT.

A....250-1500  
AP....250-1500  
B....250-1500  
C....1251-1700  
CB....250-1500  
DC-EP...250-699  
P....250-1500

GC...  
101-150  
HC...  
0-499  
**BS-4D**

**BS-6**  
FOR: B & S®

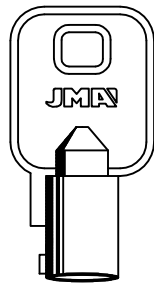

LAT.



**CHI-1T**  
FOR: CHICAGO®

FOR: EURO LOCKS® -FORT® -GELM® -L&F®

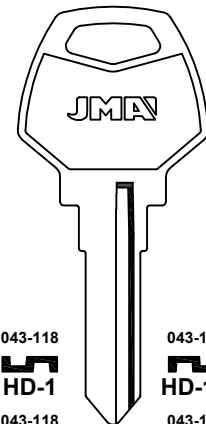

043-118  
**HD-1**  
043-118  
**HD-2**  
043-118  
**HD-3**

FOR: HARLEY DAVIDSON®

043-118  
**HD-1D**  
043-118  
**HD-2D**  
043-118  
**HD-3D**

FOR: HARLEY DAVIDSON®

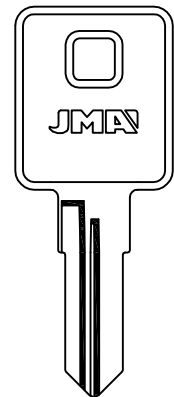

**HD-4D**  
FOR: HARLEY DAVIDSON®

FOR: HARLEY DAVIDSON®

FOR: HARLEY DAVIDSON®

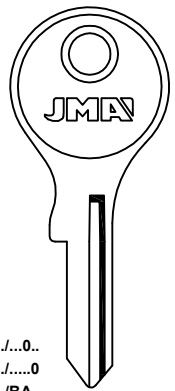

.0.../...0...  
...0.../...0...  
AA.../BA...  
CA.../EA...  
Z.../Z...  
...Z.../Z...  
...Z.../Z...  
1 AL 5

**NE-6**  
FOR: NEIMAN®

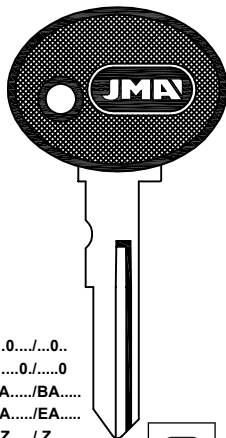

.0.../...0...  
...0.../...0...  
AA.../BA...  
CA.../EA...  
Z.../Z...  
...Z.../Z...  
...Z.../Z...  
1 AL 5

**NE-6.P**  
FOR: NEIMAN®

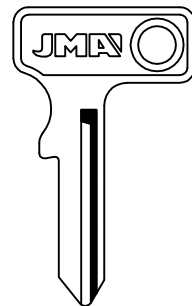

.0.../...0...  
...0.../...0...  
AA.../BA...  
CA...  
1 AL 5

**NE-8**  
FOR: NEIMAN®  
FOR: CLAUSSOR®

FOR: HERCULES®

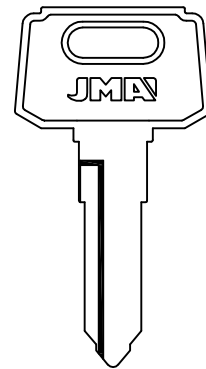

7001-8000  
**YAMA-21I**  
FOR: YAMAHA®

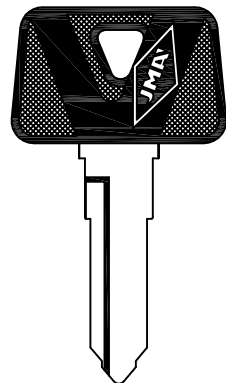

7001-7999  
**YAMA-21I.P**  
FOR: YAMAHA®

FOR: HONDA®

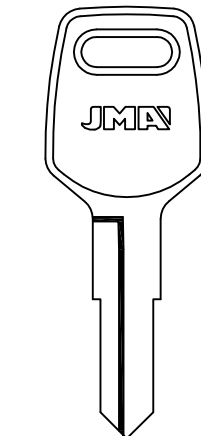

1 AL 4  
**HOND-3I** **HOND-3D**  
FOR: HONDA®

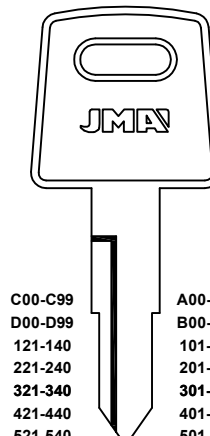

C00-C99  
D00-D99  
121-140  
221-240  
321-340  
421-440  
521-540  
621-640  
721-740  
821-840

**HOND-4I** **HOND-4D**  
FOR: HONDA®

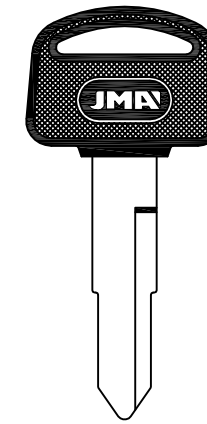

**HOND-25.P2**

**HOND-30.P2** **HOND-30D.P2**  
FOR: HONDA®

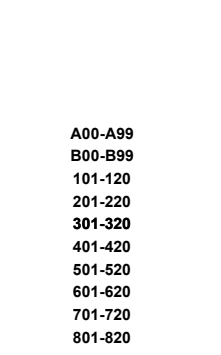

A00-A99  
B00-B99  
101-120  
201-220  
301-320  
401-420  
501-520  
601-620  
701-720  
801-820

**HOND-4D.P2**

**HOND-4I.P** **HOND-4D.P**  
FOR: HONDA®

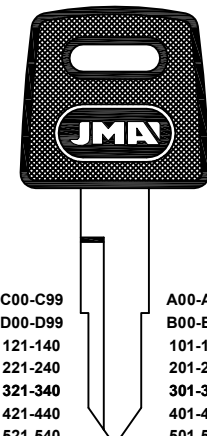

C00-C99  
D00-D99  
121-140  
221-240  
321-340  
421-440  
521-540  
621-640  
721-740  
821-840

**HOND-4I.P** **HOND-4D.P**  
FOR: HONDA®

FOR: HONDA®

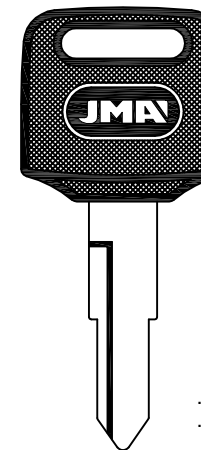

...C00-C99  
...D00-D99  
**HOND-4I.P1**

**HOND-18.P**  
FOR: HONDA®



...A00-A99  
...B00-B99  
**HOND-4D.P1**

**HOND-18D.P**

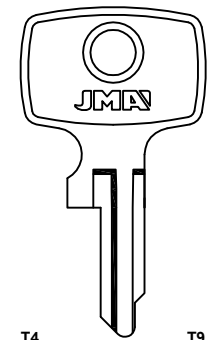

T4  
**HOND-5I**  
T1  
**HOND-6I**  
T3  
**HOND-7I**

**HOND-7I** **HOND-7D**  
FOR: HONDA®

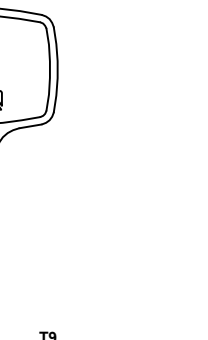

T9  
**HOND-5D**  
T6  
**HOND-6D**  
T8  
**HOND-7D**

**HOND-7D**

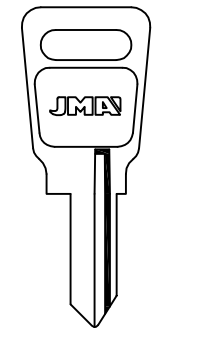

**HOND-8I** **HOND-8D**  
FOR: HONDA®

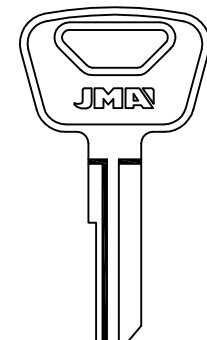

**HOND-9I** **HOND-9D**  
FOR: HONDA®

Concerning the marks and commercial denominations see legal warning.  
Concerniente a las marcas y denominaciones comerciales ver aviso legal.  
Marka eta izendapen komertzialiei dagokienez, ikus lege-oharra.  
Concernant les marques et denominations commerciales voir la note dans l'index.

**JMA** Opening the future

**JMA** Opening the future

Beziehen auf die marke und handelsname sehen sie die notiz im Impressum.  
Relativamente às marcas e denominações comerciais, ver aviso legal.  
Jeśli chodzi o znaki i nazwy handlowe, patrz Informacje prawne.

**K04** / 327



FOR: HONDA®

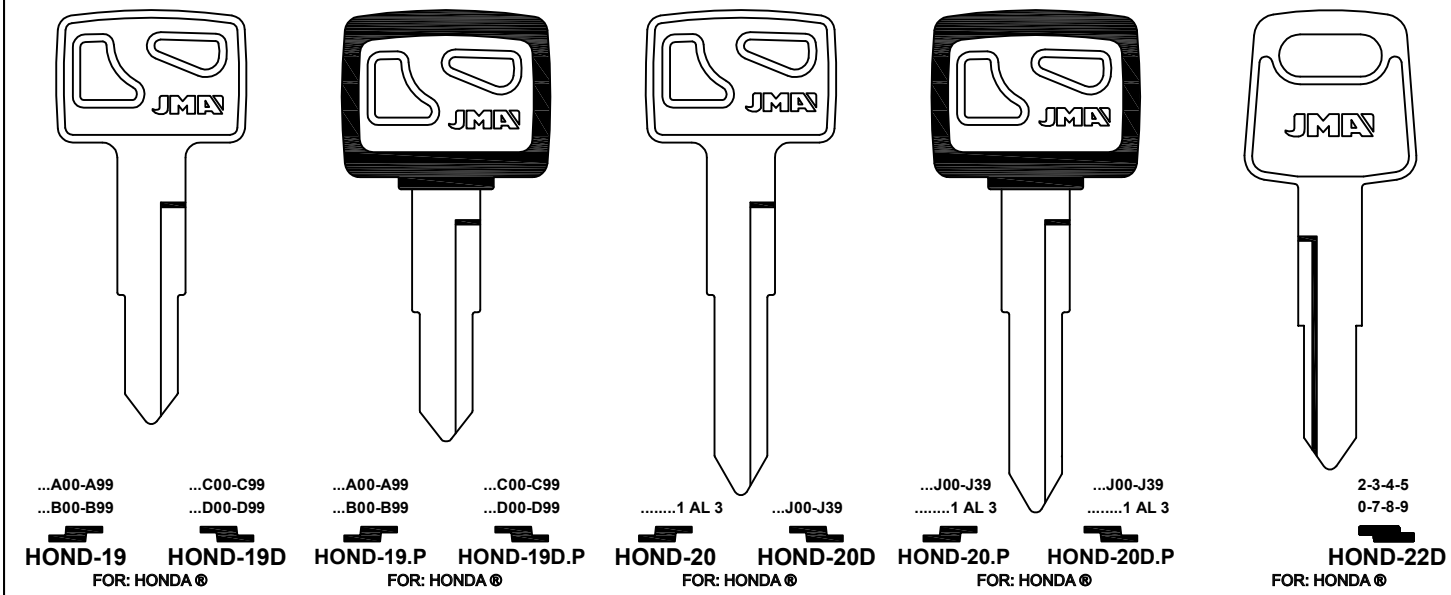

FOR: HONDA®

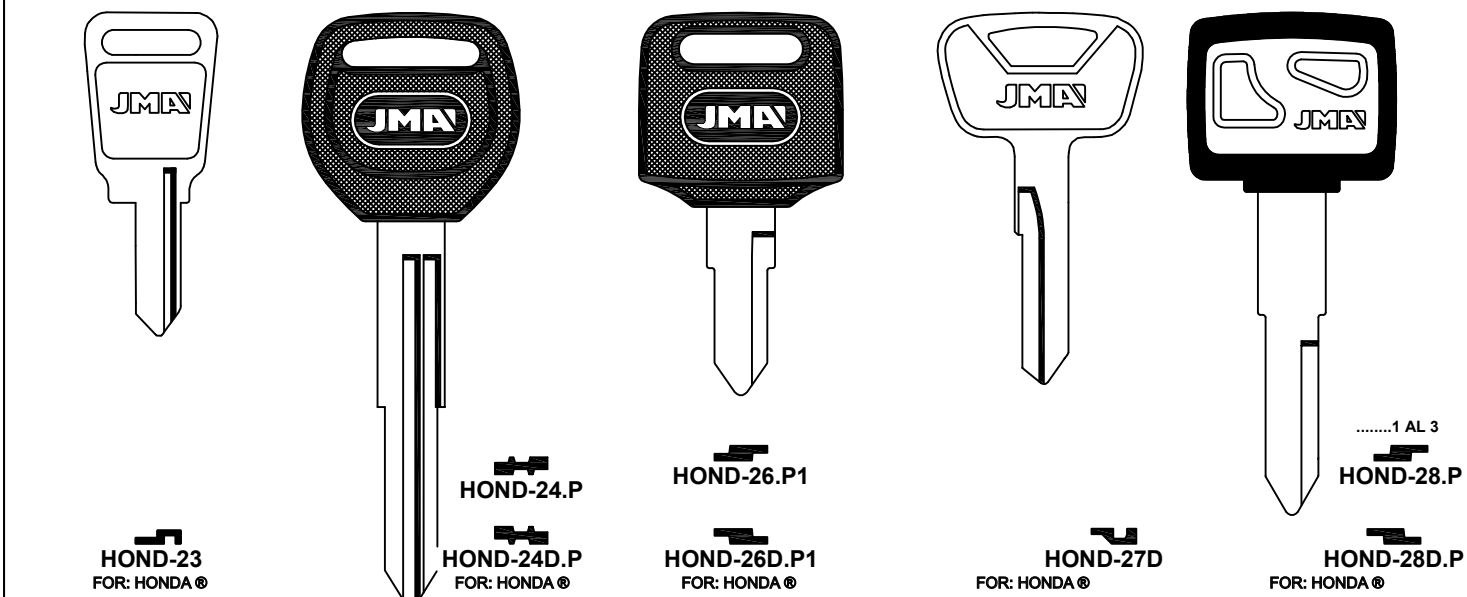

FOR: HONDA®

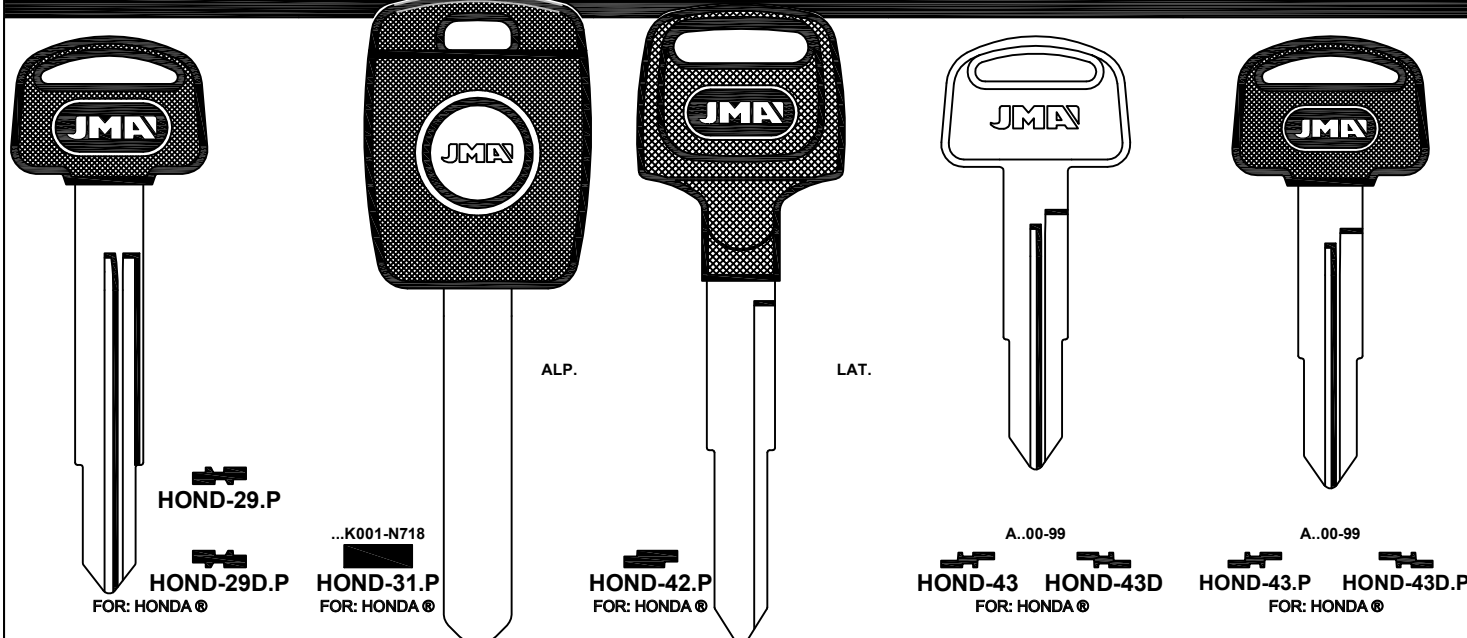

FOR: HONDA®

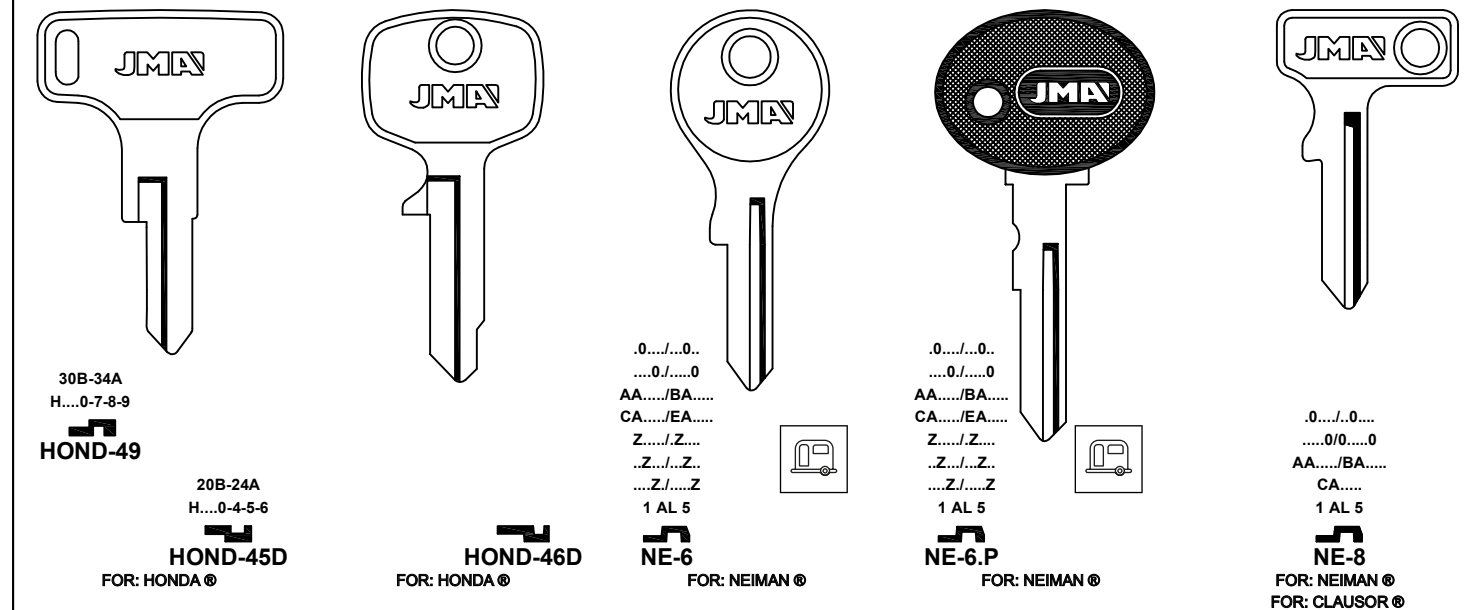

FOR: HONDA®

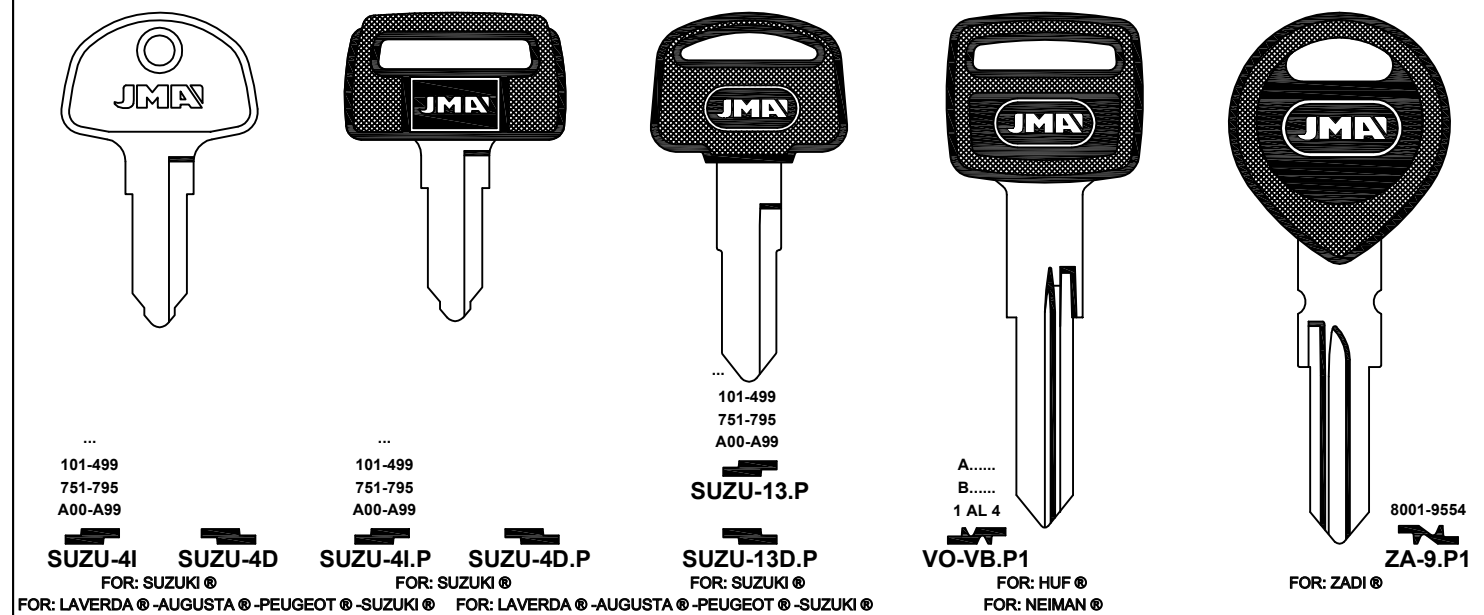

FOR: ITALJET®

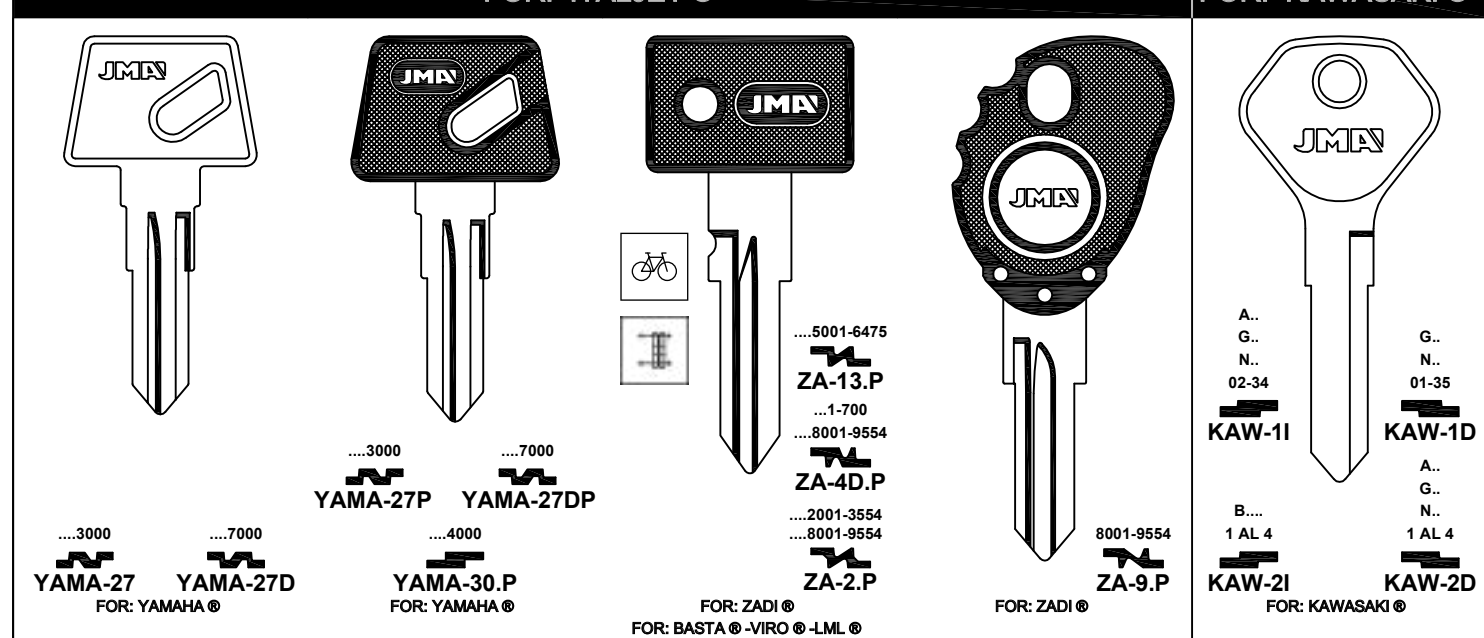

FOR: KAWASAKI®

Concerning the marks and commercial denominations see legal warning.  
Concerniente a las marcas y denominaciones comerciales ver aviso legal.  
Marka eta izendapen komertzialiei dagokienez, ikus lege-oharra.  
Concernant les marques et dénominations commerciales voir la note dans l'index.

**JMA** Opening the future

**JMA** Opening the future

Beziehen auf die Marke und Handelsname sehen sie die Notiz im Impressum.  
Relativamente às marcas e denominações comerciais, ver aviso legal.  
Jeśli chodzi o znaki i nazwy handlowe, patrz Informacje prawne.



FOR: KAWASAKI®

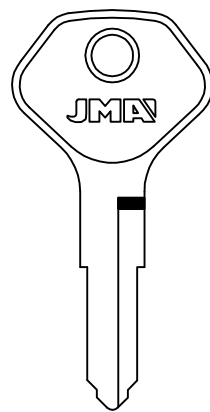

Z  
5000-6000

**KAW-3**  
FOR: KAWASAKI®

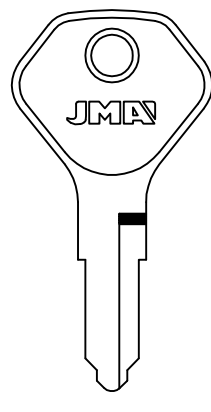

751-795  
PLC  
401-600

**KAW-4**  
FOR: KAWASAKI®

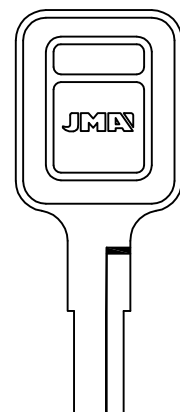

Z....  
5000-6000

**KAW-5**  
FOR: KAWASAKI®

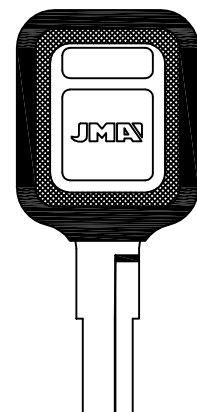

Z....  
5000-6000

**KAW-5.P**  
FOR: KAWASAKI®

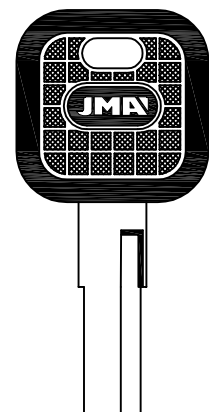

B.. 1 AL 4  
H.. 1 AL 4

**KAW-6.P KAW-6D.P**  
FOR: KAWASAKI®

FOR: KAWASAKI®

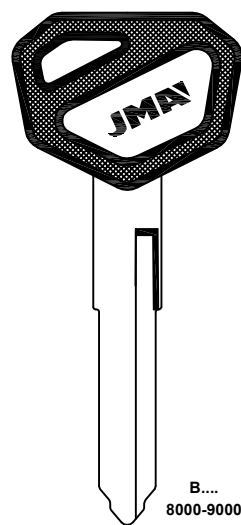

B....  
8000-9000

**KAW-7.P**  
FOR: KAWASAKI®

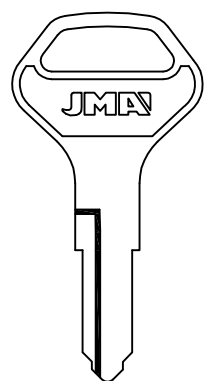

**KAW-8D**  
FOR: KAWASAKI®

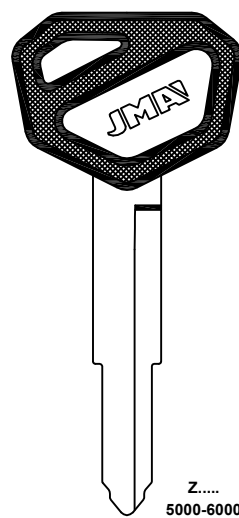

Z....  
5000-6000

**KAW-9.P**  
FOR: KAWASAKI®

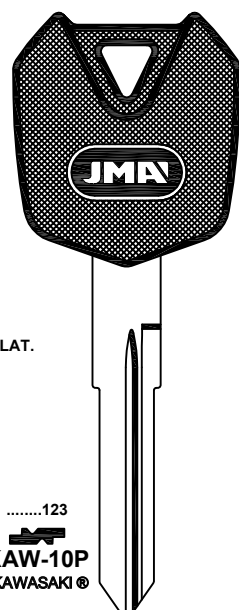

LAT.

.....123

**KAW-10P**  
FOR: KAWASAKI®

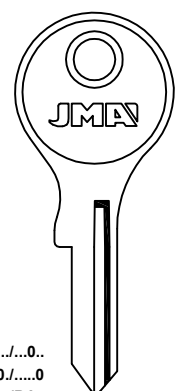

.0.../...0...  
...0.../...0...  
AA.../BA...  
CA.../EA...  
Z.../Z...  
...Z.../Z...  
...Z.../Z...  
1 AL 5

**NE-6**  
FOR: NEIMAN®

FOR: KAWASAKI®

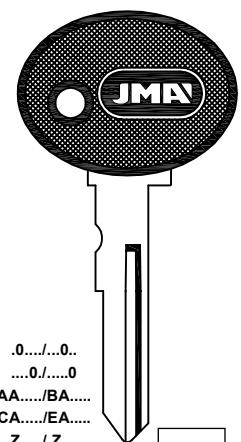

.0.../...0...  
...0.../...0...  
AA.../BA...  
CA.../EA...  
Z.../Z...  
...Z.../Z...  
1 AL 5

**NE-6.P**  
FOR: NEIMAN®

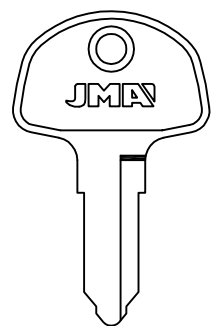

101-499  
751-795  
A00-A99

**SUZU-4I SUZU-4D**  
FOR: SUZUKI®  
FOR: LAVERDA® -AUGUSTA® -PEUGEOT® -SUZUKI®

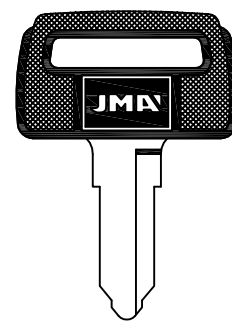

101-499  
751-795  
A00-A99

**SUZU-4I.P SUZU-4D.P**  
FOR: SUZUKI®



6001-7000

**SUZU-12.P SUZU-12D.P**  
FOR: SUZUKI®

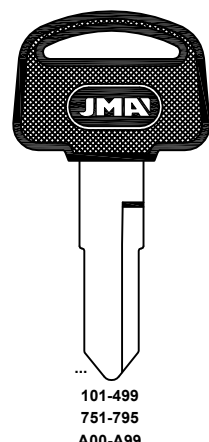

101-499  
751-795  
A00-A99

**SUZU-13.P**  
FOR: SUZUKI®

FOR: KTM®

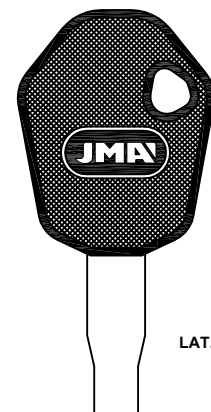

... 00001-03001  
5.8

**KM-1.P**  
FOR: KTM®

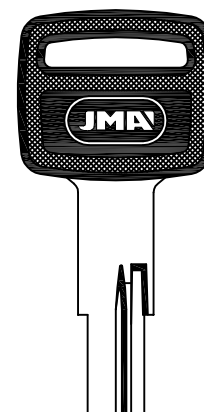

A....  
B....  
1 AL 4

**VO-VB.P1**  
FOR: HUF®  
FOR: NEIMAN®

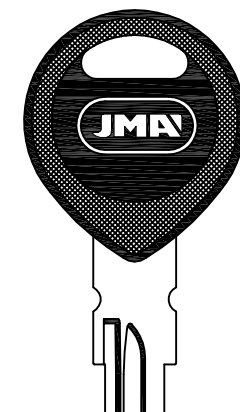

8001-9554

**ZA-9.P1**  
FOR: ZADI®

FOR: KYMCO®

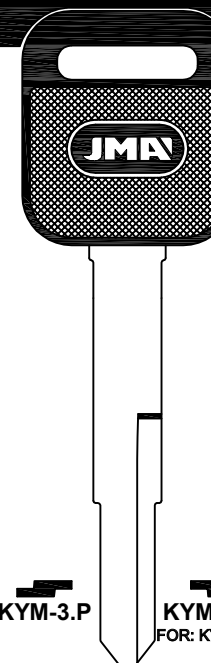

**KYM-3.P**  
FOR: KYMCO®

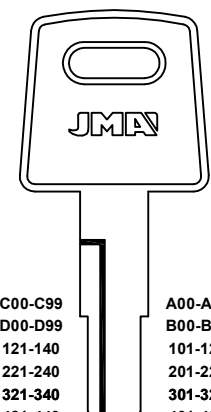

C00-C99	A00-A99
D00-D99	B00-B99
121-140	101-120
221-240	201-220
321-340	301-320
421-440	401-420
521-540	501-520
621-640	601-620
721-740	701-720
821-840	801-820

**HOND-4I HOND-4D**  
FOR: HONDA®

FOR: KYMCO®

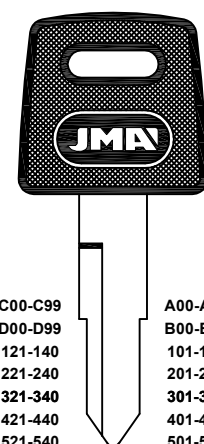

C00-C99	A00-A99
D00-D99	B00-B99
121-140	101-120
221-240	201-220
321-340	301-320
421-440	401-420
521-540	501-520
621-640	601-620
721-740	701-720
821-840	801-820

**HOND-4I.P HOND-4D.P**  
FOR: HONDA®

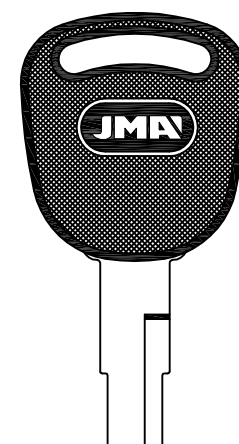

**KYM-1.P KYM-1D.P**  
FOR: KYMCO®

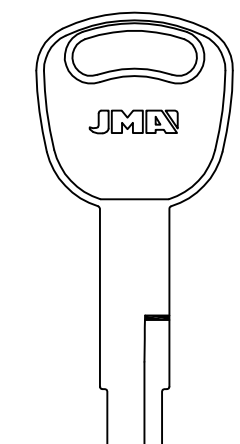

**KYM-2 KYM-2D**  
FOR: KYMCO®

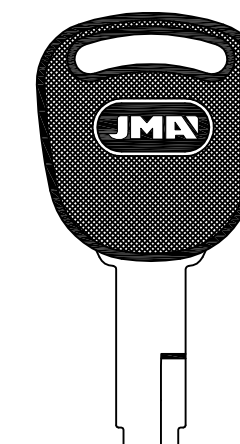

**KYM-2.P KYM-2D.P**  
FOR: KYMCO®

FOR: LAMBRETTA®

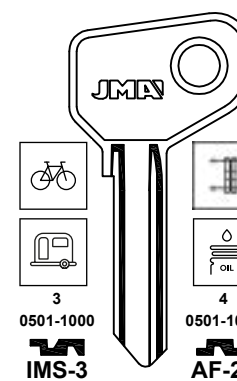

3 0501-1000 <b>IMS-3</b>	4 0501-1000 <b>AF-21</b>
--------------------------------	--------------------------------

**IMS-3 AF-19**  
FOR: SAFE®  
FOR: CROMODORA® -FIST® -IMSA®

FOR: LAMBRETTA®

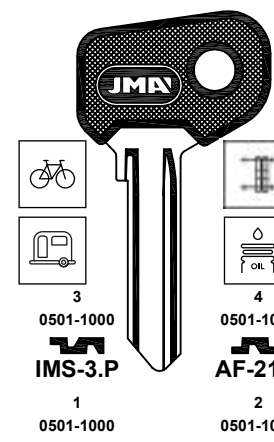

3 0501-1000 <b>IMS-3.P</b>	4 0501-1000 <b>AF-21.P</b>
----------------------------------	----------------------------------

**IMS-5.P AF-19.P**  
FOR: SAFE®  
FOR: CROMODORA® -FIST® -IMSA®

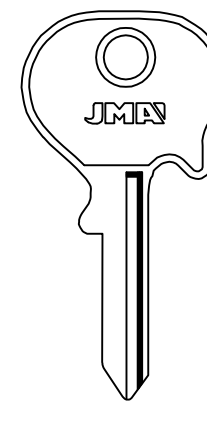

1 AL 5  
**NE-56**  
FOR: NEIMAN®

FOR: LAVERDA®

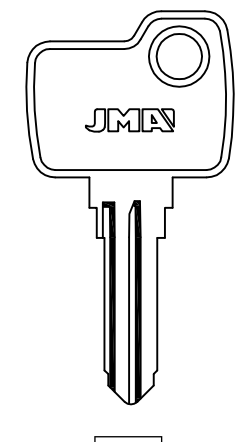

6 100-517 <b>FAR-1I</b>	8 100-517 <b>FAR-1D</b>
2 100-517 <b>FAR-2I</b>	4 100-517 <b>FAR-2D</b>
H 100-309 <b>FAR-3</b>	<b>FAR-3D</b>

**FAR-4D**  
FOR: FARMA®  
FOR: FISAM®

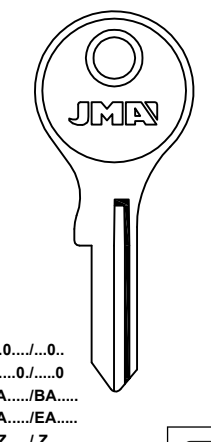

.0.../...0...  
...0.../...0...  
AA.../BA...  
CA.../EA...  
Z.../Z...  
...Z.../Z...  
1 AL 5

**NE-6**  
FOR: NEIMAN®

Concerning the marks and commercial denominations see legal warning.  
Concerniente a las marcas y denominaciones comerciales ver aviso legal.  
Marka eta izendapen komertzialiei dagokienez, ikus lege-oharra.  
Concernant les marques et dénominations commerciales voir la note dans l'index.

**JMA®** Opening the future

**JMA®** Opening the future

Beziehen auf die Marke und Handelsname sehen Sie die Notiz im Impressum.  
Relativamente às marcas e denominações comerciais, ver aviso legal.  
Jeśli chodzi o znaki i nazwy handlowe, patrz Informacje prawne.

FOR: LAVERDA®

.0.../...0...  
 ...0.../...0...  
 AA.../BA...  
 CA.../EA...  
 Z.../Z...  
 ...Z.../...Z...  
 ...Z.../...Z...  
 1 AL 5  
**NE-6.P**  
 FOR: NEIMAN®

.0.../...0...  
 ...0.../...0...  
 AA.../BA...  
 CA...  
 1 AL 5  
**NE-8**  
 FOR: NEIMAN®  
 FOR: CLAUSOR®

...  
 101-499  
 751-795  
 A00-A99  
**SUZU-4I SUZU-4D**  
 FOR: SUZUKI®  
 FOR: LAVERDA® -AUGUSTA® -PEUGEOT® -SUZUKI®

...  
 101-499  
 751-795  
 A00-A99  
**SUZU-4I.P SUZU-4D.P**  
 FOR: SUZUKI®  
 FOR: LAVERDA® -AUGUSTA® -PEUGEOT® -SUZUKI®

...  
 101-499  
 751-795  
 A00-A99  
**SUZU-13.P**  
**SUZU-13D.P**  
 FOR: SUZUKI®  
 FOR: SUZUKI®

FOR: MAICO®

.0.../...0...  
 ...0.../...0...  
 AA.../BA...  
 CA...  
 1 AL 5  
**NE-8**  
 FOR: NEIMAN®  
 FOR: CLAUSOR®

FOR: MALAGUTI®

...3000  
**YAMA-27 YAMA-27P**  
 FOR: YAMAHA®

...7000  
**YAMA-27DP**  
 FOR: YAMAHA®

...4000  
**YAMA-30.P**  
 FOR: YAMAHA®

...1-1625  
 ...5001-6278  
 E...1-710  
**ZA-1**  
 FOR: ZADI®  
 FOR: BRETER®

...1-1625  
 ...5001-6278  
 E...1-710  
**ZA-1.P**  
 FOR: ZADI®  
 FOR: BRETER®

FOR: LAVERDA®

...1-1625  
 ...5001-6278  
 E...1-710  
**ZA-1**  
 FOR: ZADI®  
 FOR: BRETER®

...1-1625  
 ...5001-6278  
 E...1-710  
**ZA-1.P**  
 FOR: ZADI®  
 FOR: BRETER®

**ZA-8.P**  
 FOR: ZADI®

FOR: LINCE®

FOR:  
 CROMODORA®  
 FIST®  
 FREA®  
 GIOBERT®  
 MIRAGLIO®  
 RUFFINI®

6  
 100-309  
**AF-5I**

8  
 100-309  
**AF-5D**

2  
 100-309  
**AF-6I**

4  
 100-309  
**AF-6D**

**CL-2I CL-2D**  
 FOR: CLAUSOR®

FOR: MALAGUTI®

...5001-6475  
**ZA-13.P**  
 ...1-700  
 ...8001-9554  
**ZA-4D.P**  
 ...2001-3554  
 ...8001-9554  
**ZA-2.P**

8001-9554  
**ZA-9.P2**  
 8001-9554  
**ZA-6D.P1**  
 8001-9554  
**ZA-9.P**

...5001-6475  
**ZA-13.P**  
 FOR: ZADI®  
 FOR: LML®

FOR: MALANCA®

...1-1625  
 ...5001-6278  
 E...1-710  
**ZA-1**  
 FOR: ZADI®  
 FOR: BRETER®

FOR: LINCE®

**CL-3I**  
 FOR: CLAUSOR®

FOR: MAICO®

**CL-2I CL-2D**  
 FOR: CLAUSOR®

**CL-3I**  
 FOR: CLAUSOR®

.0.../...0...  
 ...0.../...0...  
 AA.../BA...  
 CA.../EA...  
 Z.../Z...  
 ...Z.../...Z...  
 ...Z.../...Z...  
 1 AL 5  
**NE-6**  
 FOR: NEIMAN®

.0.../...0...  
 ...0.../...0...  
 AA.../BA...  
 CA.../EA...  
 Z.../Z...  
 ...Z.../...Z...  
 ...Z.../...Z...  
 1 AL 5  
**NE-6.P**  
 FOR: NEIMAN®

FOR: MALANCA®

...1-1625  
 ...5001-6278  
 E...1-710  
**ZA-1.P**  
 FOR: ZADI®  
 FOR: BRETER®

FOR: MBK®

...3000  
**YAMA-27 YAMA-27P**  
 FOR: YAMAHA®

...7000  
**YAMA-27DP**  
 FOR: YAMAHA®

...4000  
**YAMA-30.P**  
 FOR: YAMAHA®

...5001-6475  
**ZA-13.P**  
 ...1-700  
 ...8001-9554  
**ZA-4D.P**  
 ...2001-3554  
 ...8001-9554  
**ZA-2.P**

8001-9554  
**ZA-9.P2**  
 8001-9554  
**ZA-6D.P1**  
 8001-9554  
**ZA-9.P2**  
 8001-9554  
**ZA-6D.P1**  
 FOR: ZADI®

Concerning the marks and commercial denominations see legal warning.  
 Concerniente a las marcas y denominaciones comerciales ver aviso legal.  
 Marka eta izendapen komertzialiei dagokienez, ikus lege-oharra.  
 Concernant les marques et denominations commerciales voir la note dans l'index.

**JMA** Opening the future

**JMA** Opening the future

Beziehen auf die marke und handelsname sehen sie die notiz im Impressum.  
 Relativamente às marcas e denominações comerciais, ver aviso legal.  
 Jeśli chodzi o znaki i nazwy handlowe, patrz Informacje prawne.



**FOR: MBK®**

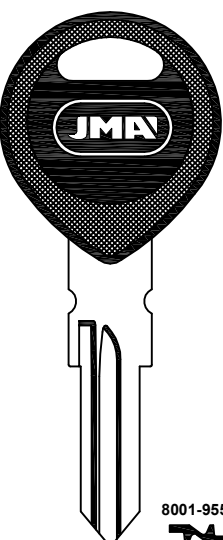

8001-9554  
ZA-9.P1  
FOR: ZADI®

**FOR: MBM®**

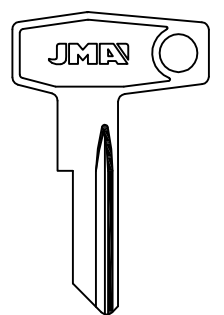

.....1-1625  
.....5001-6278  
E...1-710  
ZA-1  
FOR: ZADI®  
FOR: BRETER®

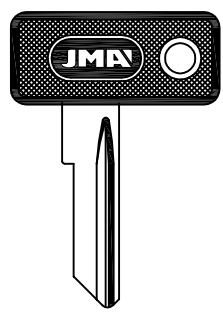

.....1-1625  
.....5001-6278  
E...1-710  
ZA-1.P  
FOR: ZADI®  
FOR: BRETER®

**FOR: MONTESA®**

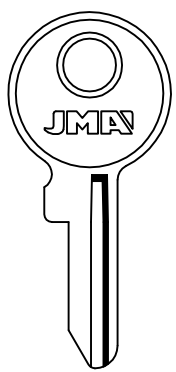

CL-21 CL-2D  
FOR: CLAUSOR®

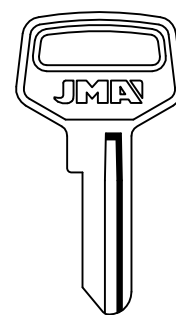

CL-31  
FOR: CLAUSOR®

**FOR: MOTO GUZZI®**

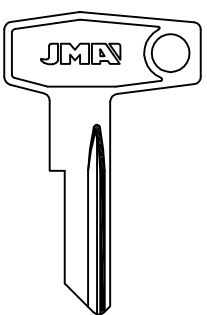

.....1-1625  
.....5001-6278  
E...1-710  
ZA-1  
FOR: ZADI®  
FOR: BRETER®

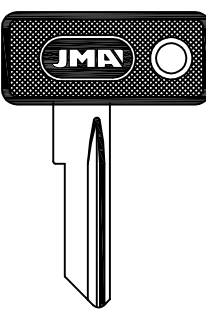

.....1-1625  
.....5001-6278  
E...1-710  
ZA-1.P  
FOR: ZADI®  
FOR: BRETER®

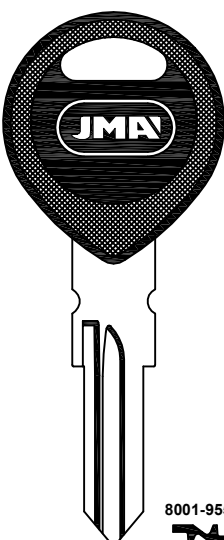

8001-9554  
ZA-9.P1  
FOR: ZADI®

**FOR: MOTO MORINI®**

FOR: CROMODORA®  
FIST®  
FREA®  
GIOBERT®  
MIRAGLIO®  
RUFFINI®

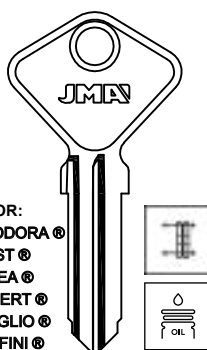

6  
100-309  
AF-5I

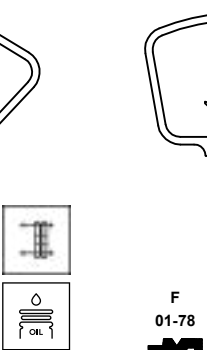

8  
100-309  
AF-5D

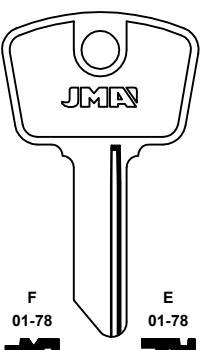

F 01-78  
FEM-1I

E 01-78  
FEM-1D

H 01-78  
FEM-2I

G 01-78  
FEM-2D

2  
100-309  
AF-6I

4  
100-309  
AF-6D

FEM-3I FEM-3D  
FOR: FEMSA®

FOR: SAFE®

**FOR: MORINI FRANCO®**

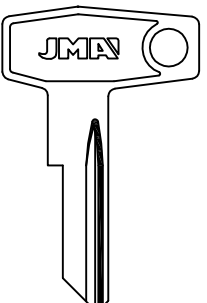

.....1-1625  
.....5001-6278  
E...1-710  
ZA-1  
FOR: ZADI®  
FOR: BRETER®

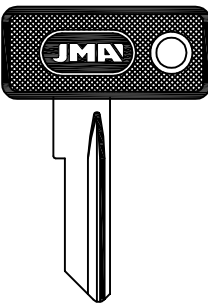

.....1-1625  
.....5001-6278  
E...1-710  
ZA-1.P  
FOR: ZADI®  
FOR: BRETER®

**FOR: MOTO GUZZI®**

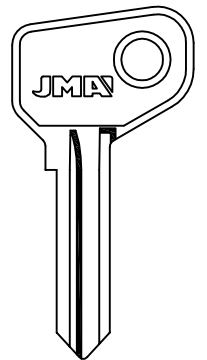

2  
100-309  
FAB-1  
FOR: FAAB®

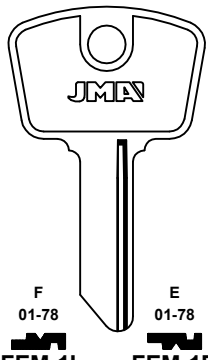

F 01-78  
FEM-1I

E 01-78  
FEM-1D

H 01-78  
FEM-2I

G 01-78  
FEM-2D

FEM-3I FEM-3D  
FOR: FEMSA®

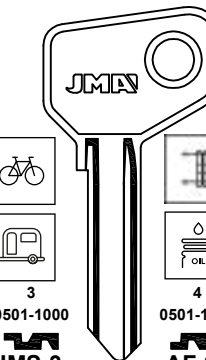

3 0501-1000  
IMS-3

4 0501-1000  
AF-21

1 0501-1000  
IMS-5

2 0501-1000  
AF-19

IMS-13  
FOR: SAFE®  
FOR: CROMODORA® -FIST® -IMSA®

**FOR: MOTO MORINI®**

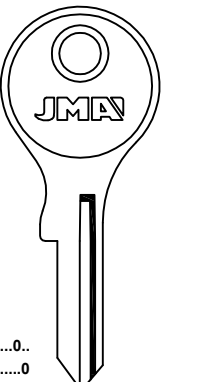

.0.../...0.  
...0.../...0  
AA.../BA...  
CA.../EA...  
Z.../Z...  
...Z.../Z...  
...Z.../Z...  
1 AL 5  
NE-6  
FOR: NEIMAN®

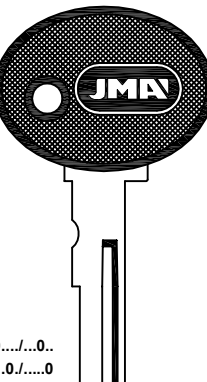

.0.../...0.  
...0.../...0  
AA.../BA...  
CA.../EA...  
Z.../Z...  
...Z.../Z...  
...Z.../Z...  
1 AL 5  
NE-6.P  
FOR: NEIMAN®

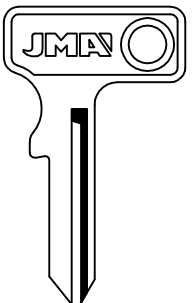

.0.../...0...  
...0/0.../...0  
AA.../BA...  
CA...  
1 AL 5  
NE-8  
FOR: NEIMAN®  
FOR: CLAUSOR®

**FOR: MOTO MORINI®**

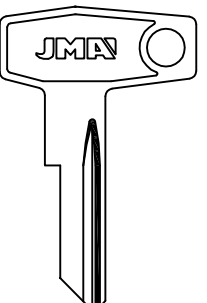

.....1-1625  
.....5001-6278  
E...1-710  
ZA-1  
FOR: ZADI®  
FOR: BRETER®

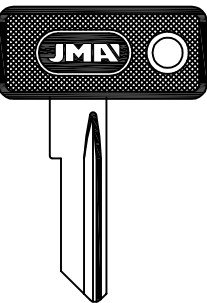

.....1-1625  
.....5001-6278  
E...1-710  
ZA-1.P  
FOR: ZADI®  
FOR: BRETER®

**FOR: MOTO GUZZI®**

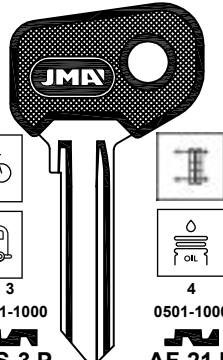

3 0501-1000  
IMS-3.P

4 0501-1000  
AF-21.P

1 0501-1000  
IMS-5.P

2 0501-1000  
AF-19.P

IMS-13.P  
FOR: SAFE®  
FOR: CROMODORA® -FIST® -IMSA®

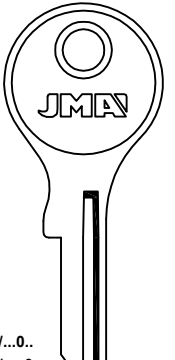

.0.../...0.  
...0.../...0  
AA.../BA...  
CA.../EA...  
Z.../Z...  
...Z.../Z...  
...Z.../Z...  
1 AL 5  
NE-6  
FOR: NEIMAN®

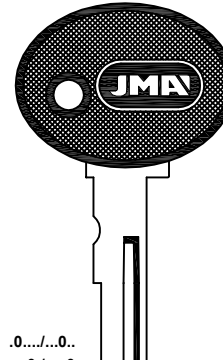

.0.../...0.  
...0.../...0  
AA.../BA...  
CA.../EA...  
Z.../Z...  
...Z.../Z...  
...Z.../Z...  
1 AL 5  
NE-6.P  
FOR: NEIMAN®

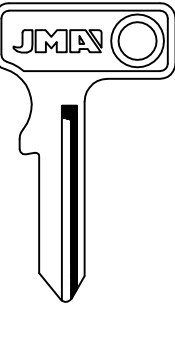

.0.../...0...  
...0/0.../...0  
AA.../BA...  
CA...  
1 AL 5  
NE-8  
FOR: NEIMAN®

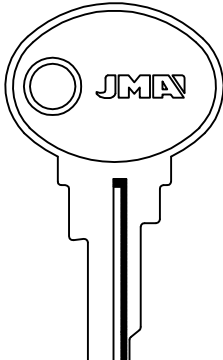

B...501-3278  
B...0-4-6-8-9  
SIP-3  
FOR: SIPEA®  
FOR: ARTEB® -CLAUSOR® -NEIMAN®

**FOR: MOTOBECANE®**

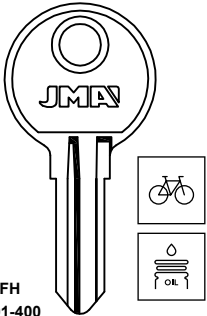

FH 001-400  
501-550  
LAS-3

H LAS-5

U LAS-U

E LAS-5D

X LAS-X

NE-6  
FOR: NEIMAN®

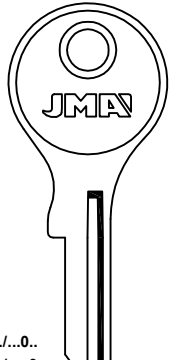

.0.../...0.  
...0.../...0  
AA.../BA...  
CA.../EA...  
Z.../Z...  
...Z.../Z...  
...Z.../Z...  
1 AL 5  
NE-6  
FOR: NEIMAN®

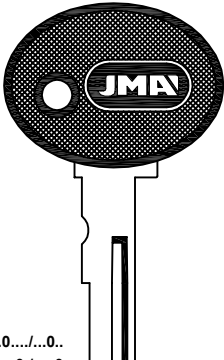

.0.../...0.  
...0.../...0  
AA.../BA...  
CA.../EA...  
Z.../Z...  
...Z.../Z...  
...Z.../Z...  
1 AL 5  
NE-6.P  
FOR: NEIMAN®

**FOR: MOTOBECANE®**

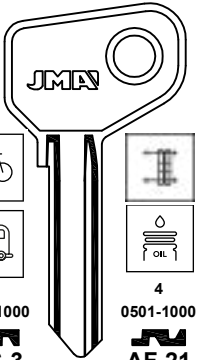

3 0501-1000  
IMS-3

4 0501-1000  
AF-21

1 0501-1000  
IMS-5

2 0501-1000  
AF-19

IMS-13  
FOR: SAFE®  
FOR: CROMODORA® -FIST® -IMSA®

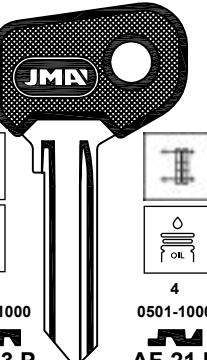

3 0501-1000  
IMS-3.P

4 0501-1000  
AF-21.P

1 0501-1000  
IMS-5.P

2 0501-1000  
AF-19.P

IMS-13.P  
FOR: SAFE®  
FOR: CROMODORA® -FIST® -IMSA®



**FOR: MOTABI®**

...0.../...0...  
...0/0...0  
AA.../BA...  
CA...  
1 AL 5  
**NE-8**  
FOR: NEIMAN®  
FOR: CLAUSOR®

**FOR: MOTRON®**

...1-1625  
...5001-6278  
E...1-710  
**ZA-1**  
FOR: ZADI®  
FOR: BRETER®

...1-1625  
...5001-6278  
E...1-710  
**ZA-1.P**  
FOR: ZADI®  
FOR: BRETER®

**FOR: MV AUGUSTA®**

A  
0501-3278  
0,4,6,8,9  
**AF-7I**  
H  
01-78  
**AF-8I**  
F  
01-78  
**AF-9I**  
FOR: SIPEA®  
FOR: SAFE®

A  
0501-3278  
0,4,6,8,9  
**AF-7D**  
G  
01-78  
**AF-8D**  
E  
01-78  
**AF-9D**  
FOR: SIPEA®  
FOR: SAFE®

A  
0501-3278  
0,4,6,8,9  
**AF-7I.P**  
H  
01-78  
**AF-8I.P**  
F  
01-78  
**AF-9I.P**  
FOR: SIPEA®  
FOR: SAFE®

A  
0501-3278  
0,4,6,8,9  
**AF-7D.P**  
G  
01-78  
**AF-8D.P**  
E  
01-78  
**AF-9D.P**  
FOR: SIPEA®  
FOR: SAFE®

**FOR: NORTON®**

NRA  
FFE...1-100  
FJA...1-100  
FL...251-500  
NRA...51-90  
YFB...1-75  
FMD...1-75  
FG...1-30  
NF...1-30  
EJR...1-75  
**UN-FFE**  
MC...1-40  
MRA...251-290  
MRN...1-54  
MRN...201-250  
MRN...251-300  
**UN-MRN**  
FS...1-99  
FS...876-955  
**UN-1FS**  
FA...501-625  
**UN-44**  
FOR: UNION®

FP...  
626-750  
**UN-FP**  
HX...100  
**UN-2**  
RM...  
911-952  
**UN-44D**  
FR...  
751-875  
**UN-FR**  
NGN...1-54  
**UN-NG**  
FOR: UNION®

FK...  
01-99  
876-955  
**UN-FK**  
FOR: UNION®

FS...  
01-99  
876-955  
**UN-FS**  
FOR: UNION®

**FOR: OMC®**

...1-1625  
...5001-6278  
E...1-710  
**ZA-1**  
FOR: ZADI®  
FOR: BRETER®

...1-1625  
...5001-6278  
E...1-710  
**ZA-1.P**  
FOR: ZADI®  
FOR: BRETER®

**FOR: MV AUGUSTA®**

6  
100-517  
**FAR-1I**  
2  
100-517  
**FAR-2I**  
H  
100-309  
**FAR-3**  
FOR: FARMA®  
FOR: FISAM®

8  
100-517  
**FAR-1D**  
4  
100-517  
**FAR-2D**  
**FAR-3D**  
**FAR-4D**

F  
01-78  
**FEM-1I**  
H  
01-78  
**FEM-2I**  
FOR: FEMSA®

E  
01-78  
**FEM-1D**  
G  
01-78  
**FEM-2D**  
**FEM-3I**  
**FEM-3D**  
FOR: FEMSA®

...0.../...0...  
...0/0...0  
AA.../BA...  
CA.../EA...  
Z.../Z...  
Z.../Z...  
Z.../Z...  
Z.../Z...  
1 AL 5  
**NE-6**  
FOR: NEIMAN®

...0.../...0...  
...0/0...0  
AA.../BA...  
CA.../EA...  
Z.../Z...  
Z.../Z...  
Z.../Z...  
Z.../Z...  
1 AL 5  
**NE-6.P**  
FOR: NEIMAN®

**FOR: OSSA®**

**CAS-1D**  
FOR: CASELLAS®

**CL-2I**  
FOR: CLAUSOR®

**CL-2D**  
FOR: CLAUSOR®

**CL-3I**  
FOR: CLAUSOR®

...0.../...0...  
...0/0...0  
AA.../BA...  
CA.../EA...  
Z.../Z...  
Z.../Z...  
Z.../Z...  
Z.../Z...  
1 AL 5  
**NE-6**  
FOR: NEIMAN®

...0.../...0...  
...0/0...0  
AA.../BA...  
CA.../EA...  
Z.../Z...  
Z.../Z...  
Z.../Z...  
Z.../Z...  
1 AL 5  
**NE-6.P**  
FOR: NEIMAN®

**FOR: MV AUGUSTA®**

...  
101-499  
751-795  
A00-A99  
**SUZU-4I**  
FOR: SUZUKI®

...  
101-499  
751-795  
A00-A99  
**SUZU-4I.P**  
FOR: SUZUKI®

...  
101-499  
751-795  
A00-A99  
**SUZU-4D**  
FOR: LAVERDA® -AUGUSTA® -PEUGEOT® -SUZUKI®

...  
101-499  
751-795  
A00-A99  
**SUZU-4D.P**  
FOR: LAVERDA® -AUGUSTA® -PEUGEOT® -SUZUKI®

...  
101-499  
751-795  
A00-A99  
**SUZU-13.P**  
FOR: SUZUKI®

...  
101-499  
751-795  
A00-A99  
**SUZU-13D.P**  
FOR: SUZUKI®

**FOR: MZ®**

...5001-6475  
**ZA-13.P**  
...1-700  
...8001-9554  
**ZA-4D.P**  
...2001-3554  
...8001-9554  
**ZA-2.P**  
FOR: ZADI®  
FOR: BASTA® -VIRO® -LML®

**FOR: PERIPOLI®**

...1-1625  
...5001-6278  
E...1-710  
**ZA-1**  
FOR: ZADI®  
FOR: BRETER®

...1-1625  
...5001-6278  
E...1-710  
**ZA-1.P**  
FOR: ZADI®  
FOR: BRETER®

**FOR: PEUGEOT®**

...  
101-499  
751-795  
A00-A99  
**SUZU-4I**  
FOR: SUZUKI®

...  
101-499  
751-795  
A00-A99  
**SUZU-4D**  
FOR: SUZUKI®

**NE-45**  
FOR: NEIMAN®

**NE-45.P**  
FOR: NEIMAN®

FOR: PEUGEOT®

...  
101-499  
751-795  
A00-A99

**SUZU-13.P**  
FOR: SUZUKI®  
FOR: LAVERDA® -AUGUSTA® -PEUGEOT® -SUZUKI®

...1-1625  
...5001-6278  
E...1-710

**ZA-1**  
FOR: ZADI®  
FOR: BRETER®

FOR: PGO®

**PGO-1**  
FOR: PGO®

**PGO-2.P**  
FOR: PGO®

FOR: PIAGGIO®

...0.../...0...  
...0.../...0...  
AA.../BA...  
CA.../EA...  
Z.../Z...  
Z.../Z...  
Z.../Z...  
1 AL 5

**NE-6**  
FOR: NEIMAN®

...0.../...0...  
...0.../...0...  
AA.../BA...  
CA.../EA...  
Z.../Z...  
Z.../Z...  
Z.../Z...  
1 AL 5

**NE-6.P**  
FOR: NEIMAN®

...0.../...0...  
...0.../...0...  
AA.../BA...  
CA...  
1 AL 5

**NE-8**  
FOR: NEIMAN®  
FOR: CLAUSOR®

...1-1625  
...5001-6278  
E...1-710

**STS-11**  
FOR: PIAGGIO®

...1-1625  
...5001-6278  
E...1-710

**ZA-1**  
FOR: ZADI®  
FOR: BRETER®

...1-1625  
...5001-6278  
E...1-710

**ZA-1.P**  
FOR: ZADI®  
FOR: BRETER®

FOR: PIAGGIO®

FOR:  
CROMODORA®  
FIST®  
FREA®  
GIOBERT®  
MIRAGLIO®  
RUFFINI®

6  
100-309  
**AF-5I**

8  
100-309  
**AF-5D**

2  
100-309  
**AF-6I**

4  
100-309  
**AF-6D**

A  
0501-3278  
0,4,6,8,9  
**AF-7I**

H  
01-78  
**AF-8I**

F  
01-78  
**AF-9I**

G  
01-78  
**AF-7D**

G  
01-78  
**AF-8D**

E  
01-78  
**AF-9D**

A  
0501-3278  
0,4,6,8,9  
**AF-7I.P**

H  
01-78  
**AF-8I.P**

F  
01-78  
**AF-9I.P**

G  
01-78  
**AF-8D.P**

E  
01-78  
**AF-9D.P**

CL-2I  
CL-2D  
CL-3I

FOR: SAFE®

FOR: SIPEA®  
FOR: SAFE®

FOR: SIPEA®  
FOR: SAFE®

FOR: CLAUDOR®

FOR: CLAUDOR®

FOR: PIAGGIO®

F  
01-78  
**FEM-1I**

H  
01-78  
**FEM-2I**

2  
100-309  
**FAB-1**  
FOR: FAAB®

E  
01-78  
**FEM-1D**

G  
01-78  
**FEM-2D**

F  
01-78  
**FEM-3I**

H  
01-78  
**FEM-3D**  
FOR: FEMSA®

J  
3001-6732  
N  
6001-7000  
**FI-1**

J  
3001-6732  
N  
6001-7000  
**FI-10**  
FOR: GIOBERT®

J  
3001-6732  
N  
6001-7000  
**FI-1.P**

J  
3001-6732  
N  
6001-7000  
**FI-10.P**  
FOR: GIOBERT®

W  
0001-9640  
**FI-13.P1**  
FOR: GIOBERT®

FOR: PIAGGIO®

...5001-6475  
**ZA-13.P**

...1-700  
...8001-9554  
**ZA-4D.P**

...2001-3554  
...8001-9554  
**ZA-2.P**

8001-9554  
**ZA-7D.P1**

8001-9554  
**ZA-9.P2**

8001-9554  
**ZA-6D.P1**

8001-9554  
**ZA-7D.P**

8001-9554  
**ZA-9.P**

FOR: ZADI®  
FOR: BASTA® -VIRO® -LML®

FOR: ZADI®

FOR: ZADI®

FOR: ZADI®

FOR: ZADI®

FOR: ZADI®

FOR: PIAGGIO®

...5001-6475  
**ZA-13.P**  
FOR: ZADI®  
FOR: LML®

FOR: RALEIGH®

NRA  
FFE...1-100  
FJA...1-100  
FL...251-500  
NRA...51-90  
YFB...1-75  
FMD...1-75  
FG...1-30  
NF...1-30  
EJR...1-75

**UN-FFE**

MC...1-40  
MRA...251-290  
MRN...1-54  
MRN...201-250  
MRN...251-300

**UN-MRN**

FS...1-99  
FS...876-955

**UN-1FS**

FA...  
501-625

**UN-44**  
FOR: UNION®

HX...100  
751-875

**UN-2**

RM...  
911-952

**UN-44D**

FP...  
626-750

**UN-FP**

FR...  
751-875

**UN-FR**

NGN...1-54

**UN-NG**

FOR: RIZZATO®

...5001-6475  
**ZA-13.P**

...1-700  
...8001-9554  
**ZA-4D.P**

...2001-3554  
...8001-9554  
**ZA-2.P**  
FOR: ZADI®  
FOR: BASTA® -VIRO® -LML®

Concerning the marks and commercial denominations see legal warning.  
Concerniente a las marcas y denominaciones comerciales ver aviso legal.  
Marka eta izendapen komertzialiei dagokienez, ikus lege-oharra.  
Concernant les marques et denominations commerciales voir la note dans l'index.

**JMA** Opening the future

**JMA** Opening the future

Beziehen auf die marke und handelsname sehen sie die notiz im Impressum.  
Relativamente às marcas e denominações comerciais, ver aviso legal.  
Jeśli chodzi o znaki i nazwy handlowe, patrz Informacje prawne.

**K04** / 339

FOR: SULKI®

FOR: SUZUKI®

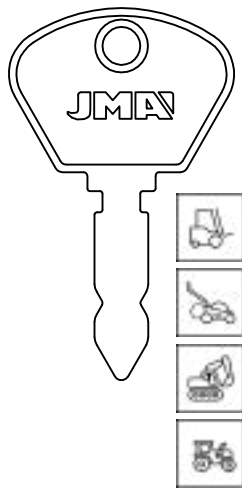

BH-4  
FOR: BOSCH®  
FOR: KOLB®-POLAR®

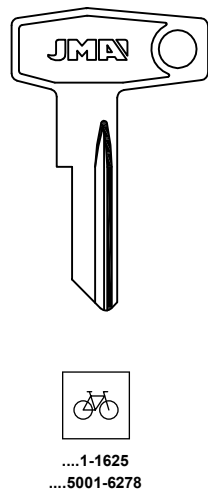

...1-1625  
...5001-6278  
E...1-710  
ZA-1  
FOR: ZADI®  
FOR: BRETER®

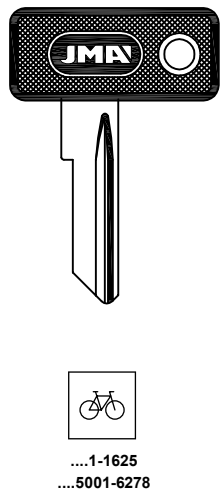

...1-1625  
...5001-6278  
E...1-710  
ZA-1.P  
FOR: ZADI®  
FOR: BRETER®

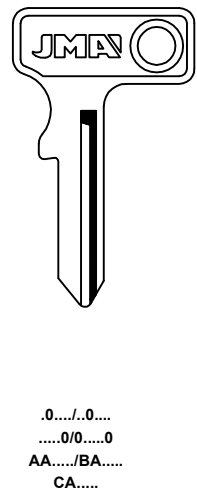

.0.../...0...  
...0/0...0  
AA.../BA...  
CA...  
1 AL 5  
NE-8  
FOR: NEIMAN®  
FOR: CLAUSOR®

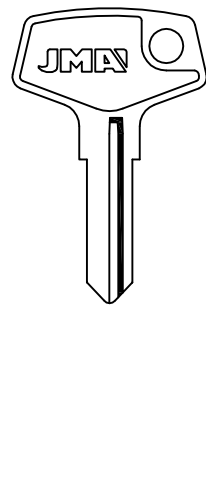

...4  
SUZU-3I  
FOR: SUZUKI®

FOR: SUZUKI®

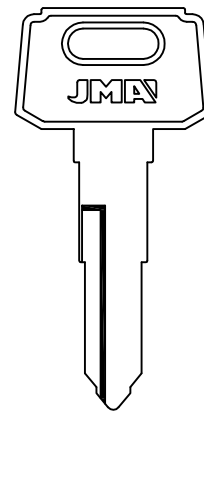

1 AL 4  
32010-79897  
A....  
32010-79897  
YAMA-18I  
C....  
32010-79897  
YAMA-19I  
E....  
32010-79897  
YAMA-20I  
FOR: YAMAHA®

B....  
32010-79897  
YAMA-18D  
D....  
32010-79897  
YAMA-19D  
F....  
32010-79897  
YAMA-20D

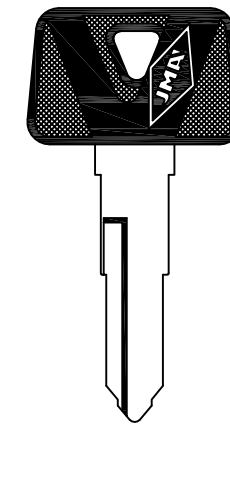

1 AL 4  
32010-79897  
A....  
32010-79897  
YAMA-18I.P  
C....  
32010-79897  
YAMA-19I.P  
E....  
32010-79897  
YAMA-20I.P  
C....  
32010-79897  
YAMA-28.P  
E....  
32010-79897  
YAMA-29.P  
FOR: YAMAHA®

B....  
32010-79897  
YAMA-18D.P  
D....  
32010-79897  
YAMA-19D.P  
F....  
32010-79897  
YAMA-20D.P

FOR: SUZUKI®

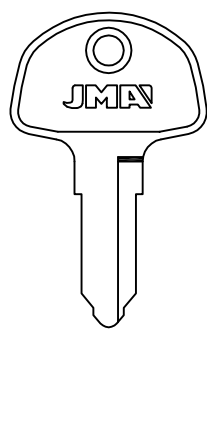

...  
101-499  
751-795  
A00-A99  
SUZU-4I  
FOR: SUZUKI®  
FOR: LAVERDA® -AUGUSTA® -PEUGEOT® -SUZUKI®

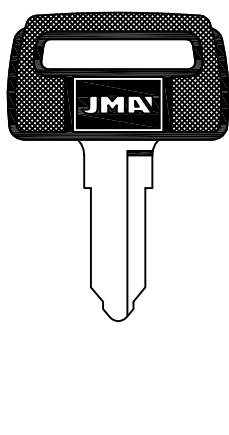

...  
101-499  
751-795  
A00-A99  
SUZU-4I.P  
FOR: SUZUKI®

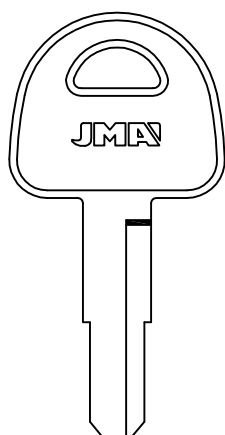

...  
101-499  
751-795  
SUZU-5  
FOR: SUZUKI®

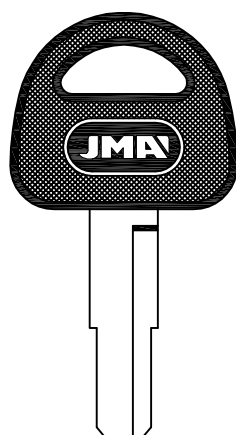

...  
101-499  
751-795  
SUZU-5.P  
FOR: SUZUKI®

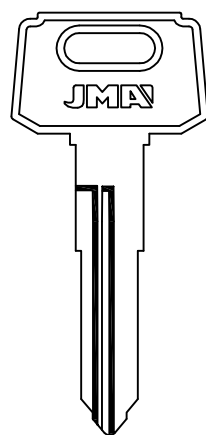

...  
6001-7000  
SUZU-11D  
FOR: SUZUKI®

FOR: SUZUKI®

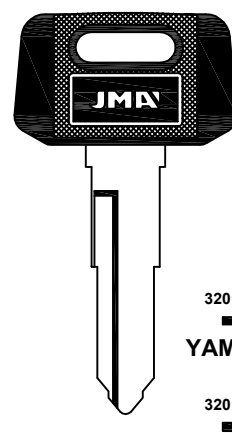

1 AL 4  
32010-79897  
A....  
32010-79897  
YAMA-22I.P  
C....  
32010-79897  
YAMA-23I.P  
E....  
32010-79897  
YAMA-24I.P  
FOR: YAMAHA®

B....  
32010-79897  
YAMA-22D.P  
D....  
32010-79897  
YAMA-23D.P  
F....  
32010-79897  
YAMA-24D.P

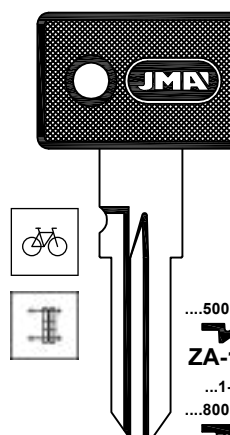

...5001-6475  
ZA-13.P  
...1-700  
...8001-9554  
ZA-4D.P  
...2001-3554  
...8001-9554  
ZA-2.P  
FOR: ZADI®  
FOR: BASTA® -VIRO® -LML®

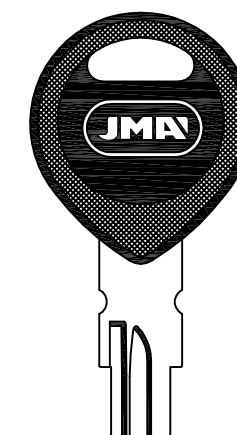

8001-9554  
ZA-9.P1  
FOR: ZADI®

FOR: SWM®

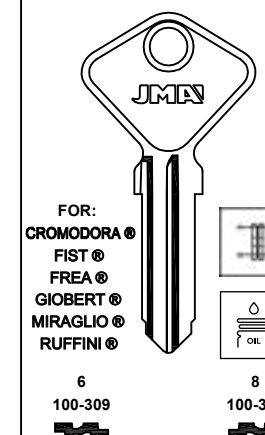

FOR:  
CROMODORA®  
FIST®  
FREA®  
GIOBERT®  
MIRAGLIO®  
RUFFINI®  
6  
100-309  
AF-5I  
2  
100-309  
AF-6I  
8  
100-309  
AF-5D  
4  
100-309  
AF-6D  
FOR: SAFE®

FOR: SUZUKI®

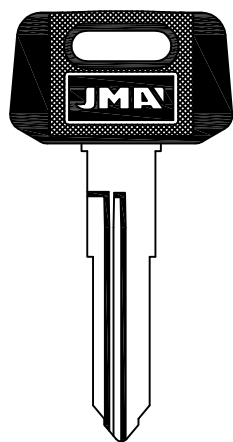

...  
6001-7000  
SUZU-11D.P  
FOR: SUZUKI®

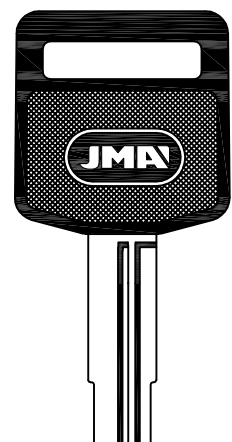

...  
6001-7000  
SUZU-12.P  
FOR: SUZUKI®

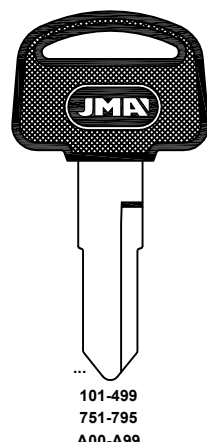

...  
101-499  
751-795  
A00-A99  
SUZU-13.P  
FOR: SUZUKI®

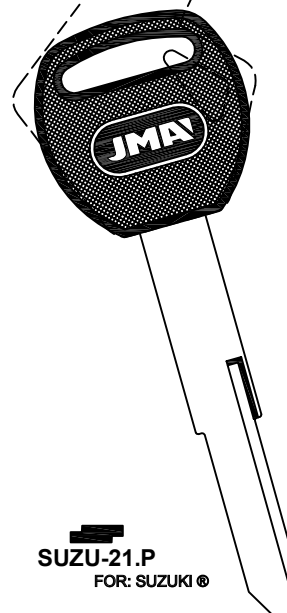

SUZU-21.P  
FOR: SUZUKI®

FOR: LAVERDA® -AUGUSTA® -PEUGEOT® -SUZUKI®

FOR: SWM®

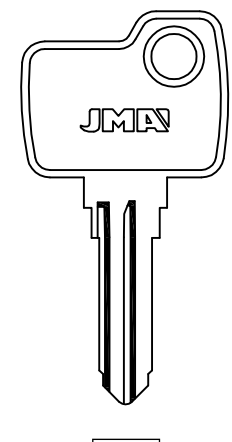

6  
100-517  
FAR-1I  
2  
100-517  
FAR-2I  
H  
100-309  
FAR-3  
FOR: FARMA®  
FOR: FISAM®

8  
100-517  
FAR-1D  
4  
100-517  
FAR-2D  
FAR-3D  
FAR-4D

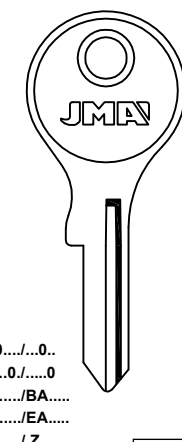

.0.../...0...  
...0/...0  
AA.../BA...  
CA.../EA...  
Z.../Z...  
...Z.../Z...  
...Z.../Z...  
1 AL 5  
NE-6  
FOR: NEIMAN®

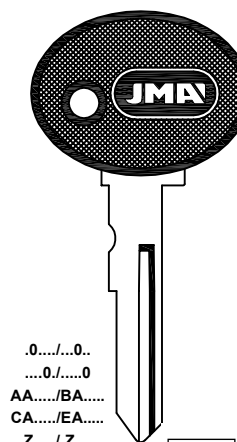

.0.../...0...  
...0/...0  
AA.../BA...  
CA.../EA...  
Z.../Z...  
...Z.../Z...  
...Z.../Z...  
1 AL 5  
NE-6.P  
FOR: NEIMAN®

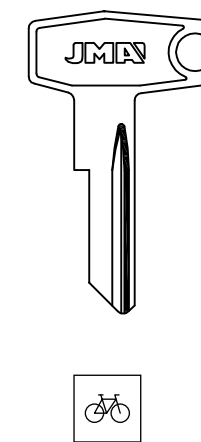

...1-1625  
...5001-6278  
E...1-710  
ZA-1  
FOR: ZADI®  
FOR: BRETER®

Concerning the marks and commercial denominations see legal warning.  
Concerniente a las marcas y denominaciones comerciales ver aviso legal.  
Marka eta izendapen komertzialiei dagokienez, ikus lege-oharra.  
Concernant les marques et denominations commerciales voir la note dans l'index.

**JMA** Opening the future



**JMA** Opening the future

Beziehen auf die marke und handelsname sehen sie die notiz im Impressum.  
Relativamente às marcas e denominações comerciais, ver aviso legal.  
Jeśli chodzi o znaki i nazwy handlowe, patrz Informacje prawne.

**K04** / 341

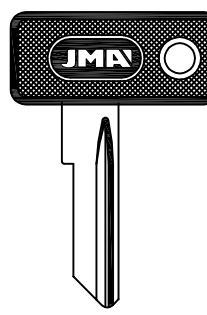

**FOR: SWM®**





...1-1625  
...5001-6278  
E...1-710

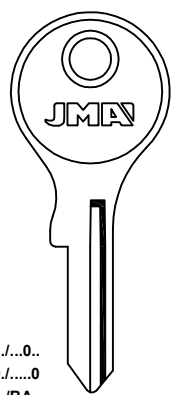

**ZA-1.P**  
FOR: ZADI®  
FOR: BRETER®

**FOR: TESTI®**





.0.../...0.  
...0.../...0  
AA.../BA...  
CA.../EA...  
Z.../Z...  
...Z.../...Z...  
...Z.../...Z  
1 AL 5

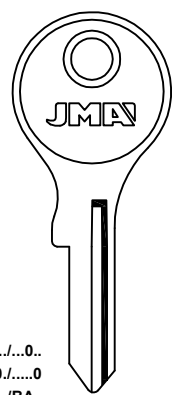

**NE-6**  
FOR: NEIMAN®

**FOR: TRIUMPH®**





.0.../...0.  
...0.../...0  
AA.../BA...  
CA.../EA...  
Z.../Z...  
...Z.../...Z...  
...Z.../...Z  
1 AL 5

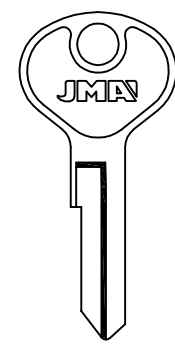

**NE-6**  
FOR: NEIMAN®

**VARIOUS BRANDS**

**TIT-7D**  
FOR: TITAN®

**FOR: YAMAHA®**

.0.../...0.  
...0.../...0  
AA.../BA...  
CA.../EA...  
Z.../Z...  
...Z.../...Z...  
...Z.../...Z  
1 AL 5

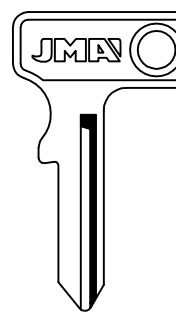
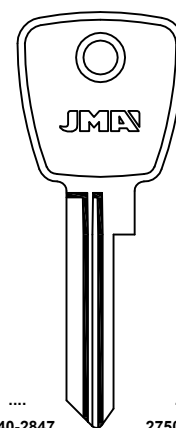
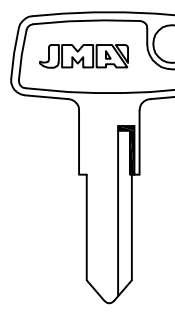
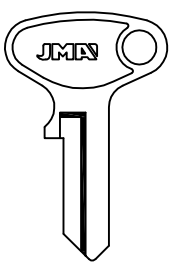
**NE-8**  
FOR: NEIMAN®  
FOR: CLAUSOR®

2840-2847  
**YAMA-11**  
2550-2557  
**YAMA-21**

2750-2757  
**YAMA-1D**  
2640-2647  
**YAMA-2D**

2611-2650  
**YAMA-31**

1711-1725  
**YAMA-3D**

**YAMA-4D**  
FOR: YAMAHA®

**FOR: TRIUMPH®**

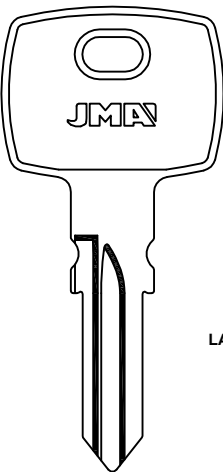
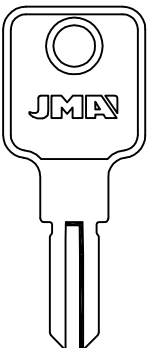
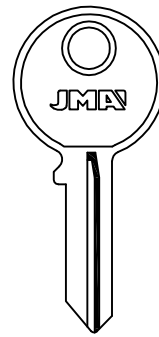
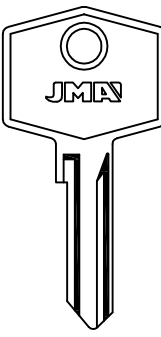
NRA  
FFE...1-100  
FJA...1-100  
FL...251-500  
NRA...51-90  
YFB...1-75  
FMD...1-75  
FG...1-30  
NF...1-30  
EJR...1-75

FP...  
626-750

**UN-FFE** **UN-3** **UN-FP**

MC...1-40  
MRA...251-290  
MRN...1-54  
MRN...201-250  
MRN...251-300

HX...100  
751-875

**UN-MRN** **UN-2** **UN-FR**

FS...1-99  
FS...876-955

FA...  
501-625

RM...  
911-952

NGN...1-54

**UN-1FS** **UN-44** **UN-44D** **UN-NG**

FK...  
01-99  
876-955

FS...  
01-99  
876-955

**UN-FK** **UN-FS**

**TRP-1D**  
FOR: TRIUMPH MOT.®  
FOR: ZADI®

**TRP-2<sup>1</sup>**  
FOR: TRIUMPH MOT.®

**UN-1FS** **UN-44** **UN-44D** **UN-NG** **UN-FK** **UN-FS**

FOR: UNION®

FOR: UNION®

FOR: WBH®

**FOR: YAMAHA®**

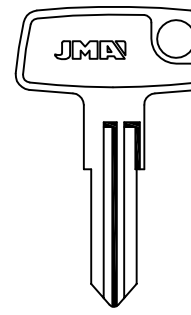
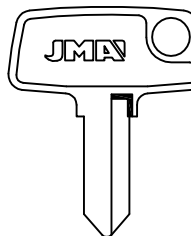
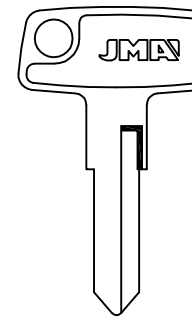
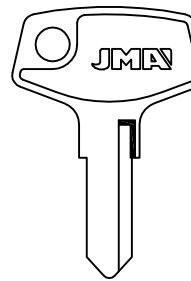
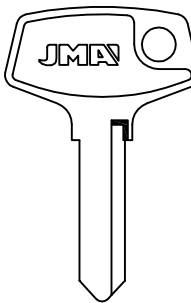
2651-2675  
**YAMA-5I**  
FOR: YAMAHA®

1751-1775  
**YAMA-5D**  
FOR: YAMAHA®

228-234  
**YAMA-6I**

221-227  
**YAMA-6D**  
FOR: YAMAHA®

2676-2700  
**YAMA-7I**

1776-1800  
**YAMA-7D**  
FOR: YAMAHA®

2109-2115  
2611-2625  
6201-6212

1209-1215  
1711-1725  
6101-6112

**YAMA-8I** **YAMA-8D**  
FOR: YAMAHA®

A201-A206  
B201-B206

A101-A106  
B101-B106

**YAMA-9I** **YAMA-9D**  
FOR: YAMAHA®

**FOR: TRIUMPH®**

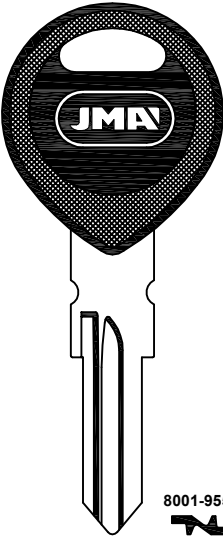

8001-9554  
**ZA-9.P1**  
FOR: ZADI®

**VARIOUS BRANDS**

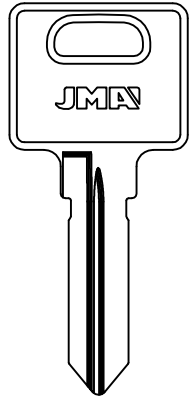

21...  
0001-9999  
**AS-19D**  
FOR: ASSA®

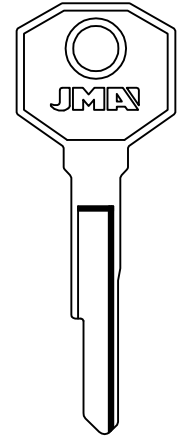

**BUR-6**  
FOR: BURG®

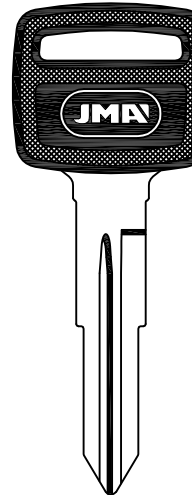

**DAL-1.P**  
FOR: DAELIM®

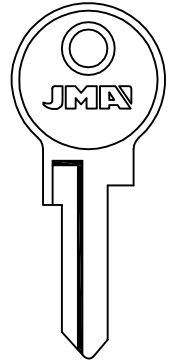

**GW-1D**  
FOR: ZUNDAPP®

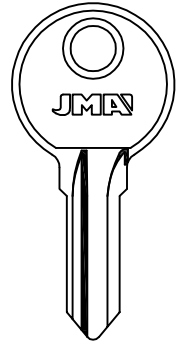

**LAS-R** **LAS-V** **LAS-Y**  
FOR: LAS®

R  
001-224

V  
001-224

Y  
001-224

FOR: DUBOIS®

FOR: KIFERM®

FOR: PJ®

FOR: PK®

**FOR: YAMAHA®**

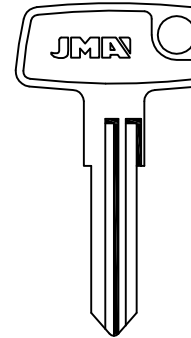

2765-2771  
**YAMA-10I**

1855-1861  
**YAMA-10D**

2758-2764  
**YAMA-11I**  
FOR: YAMAHA®

1848-1854  
**YAMA-11D**  
FOR: YAMAHA®

3201-3250  
3451-3500  
4401-4450

3101-3150  
3351-3400  
4301-4350

**YAMA-12I** **YAMA-12D**

3251-3300  
3851-3900  
4451-4500

3151-3200  
3751-3800  
4351-4400

**YAMA-13I** **YAMA-13D**

3601-3650  
3801-3950  
4601-4650

3701-3750  
4151-4200  
4751-4800

**YAMA-14I** **YAMA-14D**

3401-3450  
4051-4100  
4651-4700

3301-3350  
3951-4000  
4551-4600

**YAMA-15I** **YAMA-15D**

3651-3700  
4201-4250  
4801-4850

3551-3600  
4101-4150  
4701-4750

**YAMA-16I** **YAMA-16D**

3801-3850  
4251-4300  
4851-4900

3701-3750  
4151-4200  
4751-4800

**YAMA-17I** **YAMA-17D**

3801-3850  
4251-4300  
4851-4900

3701-3750  
4151-4200  
4751-4800

**YAMA-18I** **YAMA-18D**

32010-79897  
**YAMA-18I** **YAMA-18D**

32010-79897  
**YAMA-19I** **YAMA-19D**

32010-79897  
**YAMA-20I** **YAMA-20D**  
FOR: YAMAHA®

Concerning the marks and commercial denominations see legal warning.  
Concerniente a las marcas y denominaciones comerciales ver aviso legal.  
Marka eta izendapen komertzialiei dagokienez, ikus lege-oharra.  
Concernant les marques et dénominations commerciales voir la note dans l'index.



FOR: YAMAHA®

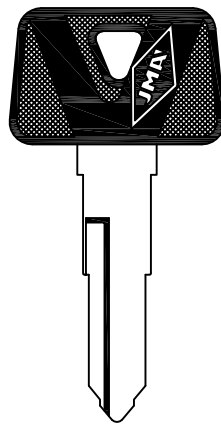

1 AL 4  
32010-79897

A.....  
32010-79897  
YAMA-18I.P

B.....  
32010-79897  
YAMA-18D.P

C.....  
32010-79897  
YAMA-19I.P

D.....  
32010-79897  
YAMA-19D.P

E.....  
32010-79897  
YAMA-20I.P

F.....  
32010-79897  
YAMA-20D.P

C.....  
32010-79897  
YAMA-28.P

E.....  
32010-79897  
YAMA-29.P  
FOR: YAMAHA®

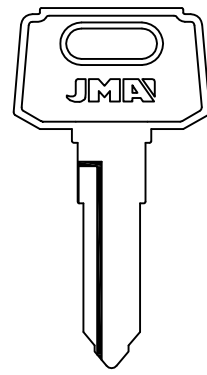

.....  
7001-8000  
YAMA-21I  
FOR: YAMAHA®

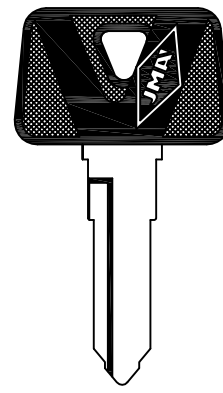

.....  
7001-7999  
YAMA-21I.P  
FOR: YAMAHA®

FOR: YAMAHA®

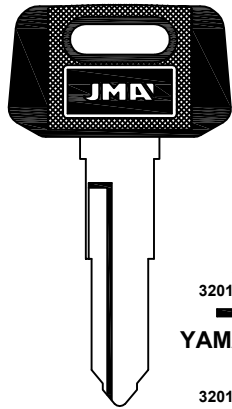

1 AL 4  
32010-79897

A.....  
32010-79897  
YAMA-22I.P

B.....  
32010-79897  
YAMA-22D.P

C.....  
32010-79897  
YAMA-23I.P

D.....  
32010-79897  
YAMA-23D.P

E.....  
32010-79897  
YAMA-24I.P  
FOR: YAMAHA®

F.....  
32010-79897  
YAMA-24D.P

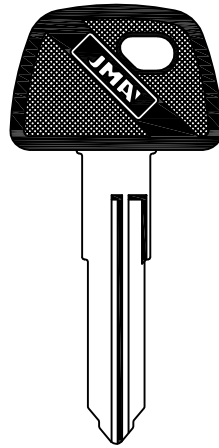

.....  
6001-7000  
YAMA-25.P  
FOR: YAMAHA®

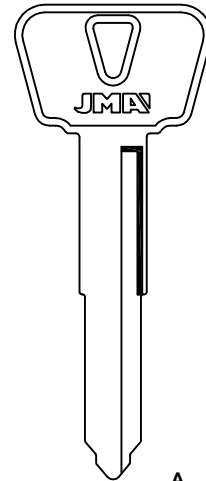

A.....  
7000-8000  
YAMA-26  
FOR: YAMAHA®

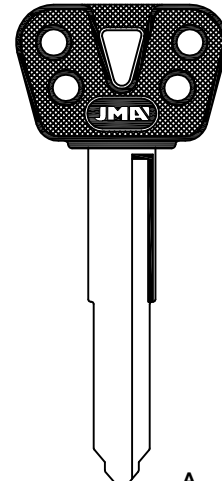

A.....  
7000-8000  
YAMA-26P  
FOR: YAMAHA®

FOR: YAMAHA®

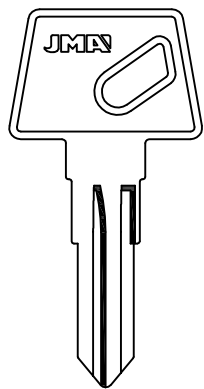

.....3000  
YAMA-27  
FOR: YAMAHA®

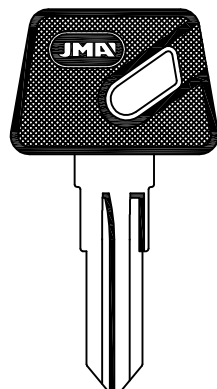

.....3000  
YAMA-27P

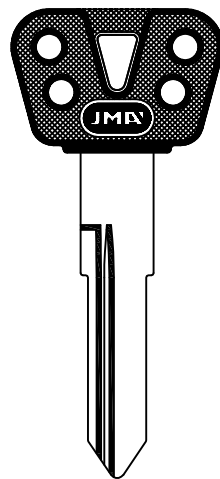

.....7000  
YAMA-30.P  
FOR: YAMAHA®

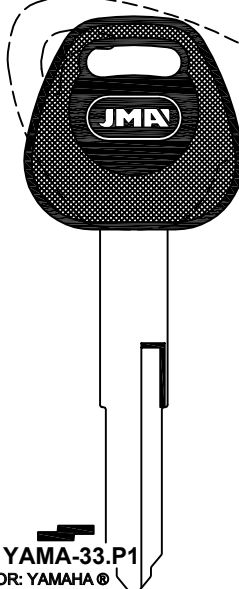

.....4000  
YAMA-32D.P  
FOR: YAMAHA®

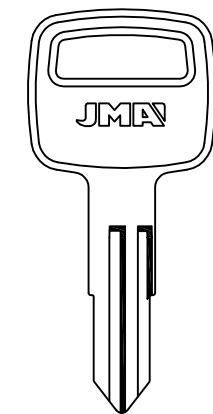

.....  
YAMA-33.P1  
FOR: YAMAHA®

.....  
YAMA-34  
YAMA-34D  
FOR: YAMAHA®

FOR: YAMAHA®

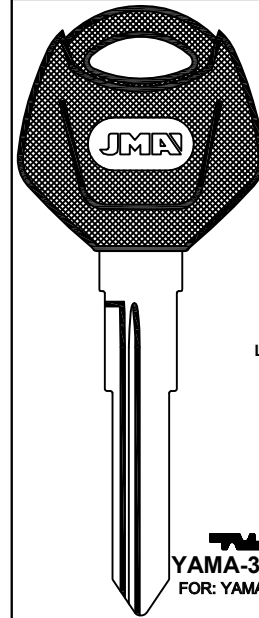

LAT.  
YAMA-36D.P  
FOR: YAMAHA®

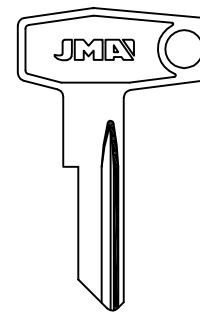

.....1-1625  
.....5001-6278  
E...1-710  
ZA-1  
FOR: ZADI®  
FOR: BRETER®

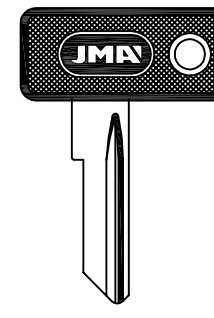

.....1-1625  
.....5001-6278  
E...1-710  
ZA-1.P  
FOR: ZADI®  
FOR: BRETER®

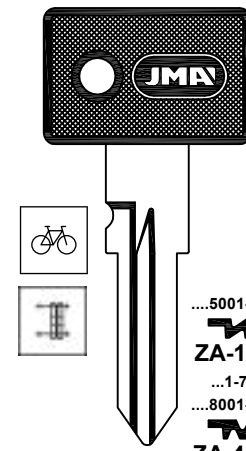

.....5001-6475  
ZA-4D.P  
.....1-700  
.....8001-9554  
.....2001-3554  
.....8001-9554  
ZA-2.P  
FOR: ZADI®  
FOR: BASTA® -VIRO® -LML®

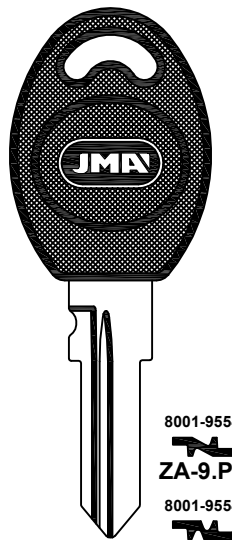

8001-9554  
ZA-9.P2  
8001-9554  
ZA-6D.P1  
FOR: ZADI®

FOR: YAMAHA®

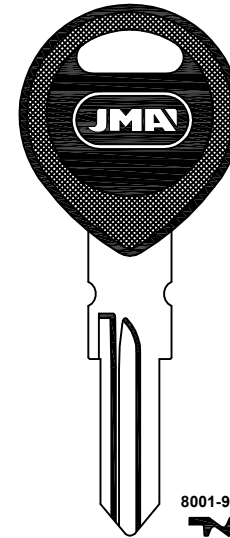

8001-9554  
ZA-9.P1  
FOR: ZADI®

Concerning the marks and commercial denominations see legal warning.  
Concerniente a las marcas y denominaciones comerciales ver aviso legal.  
Marka eta izendapen komertzialiei dagokienetz, ikus lege-oharra.  
Concernant les marques et dénominations commerciales voir la note dans l'index.

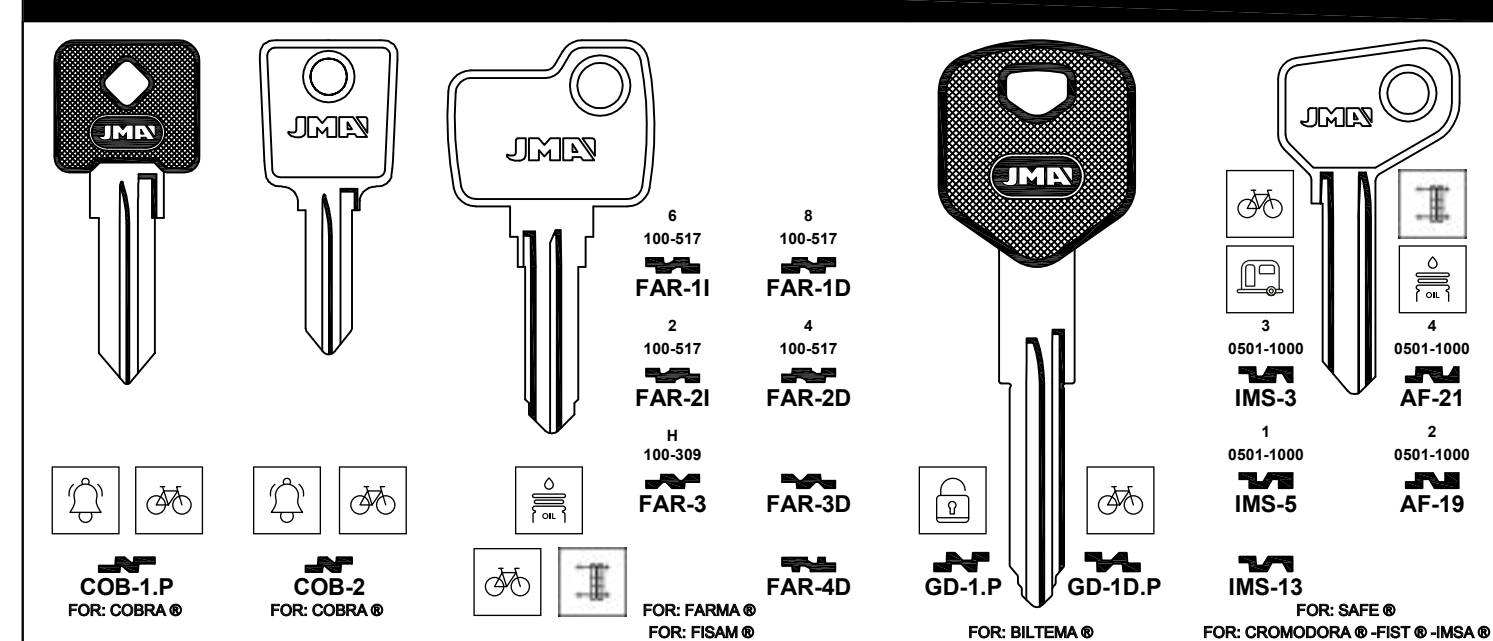
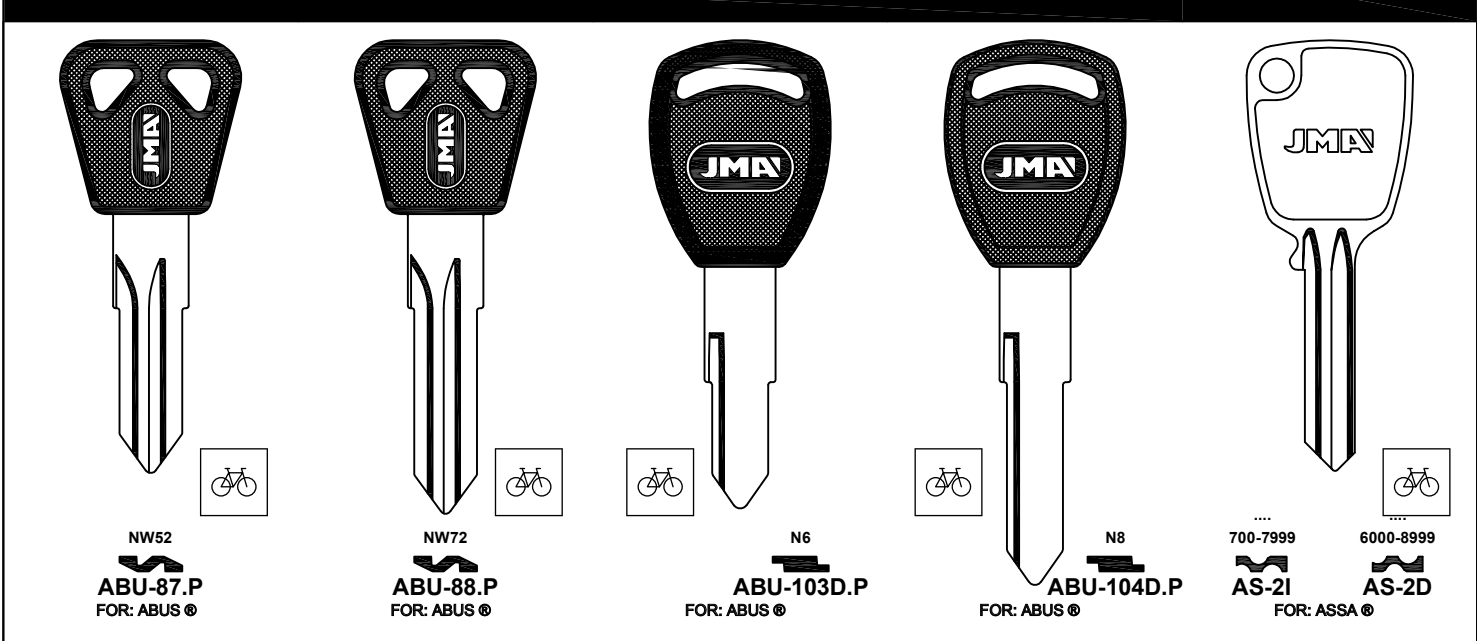
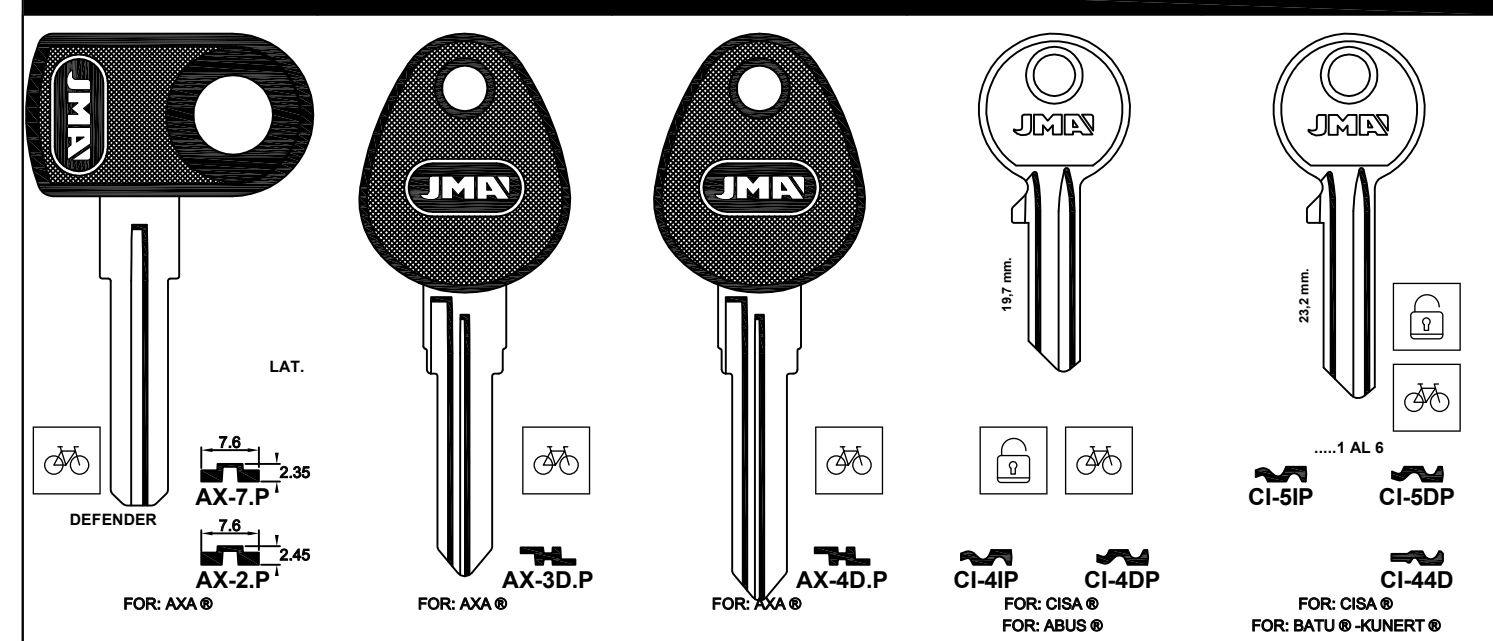
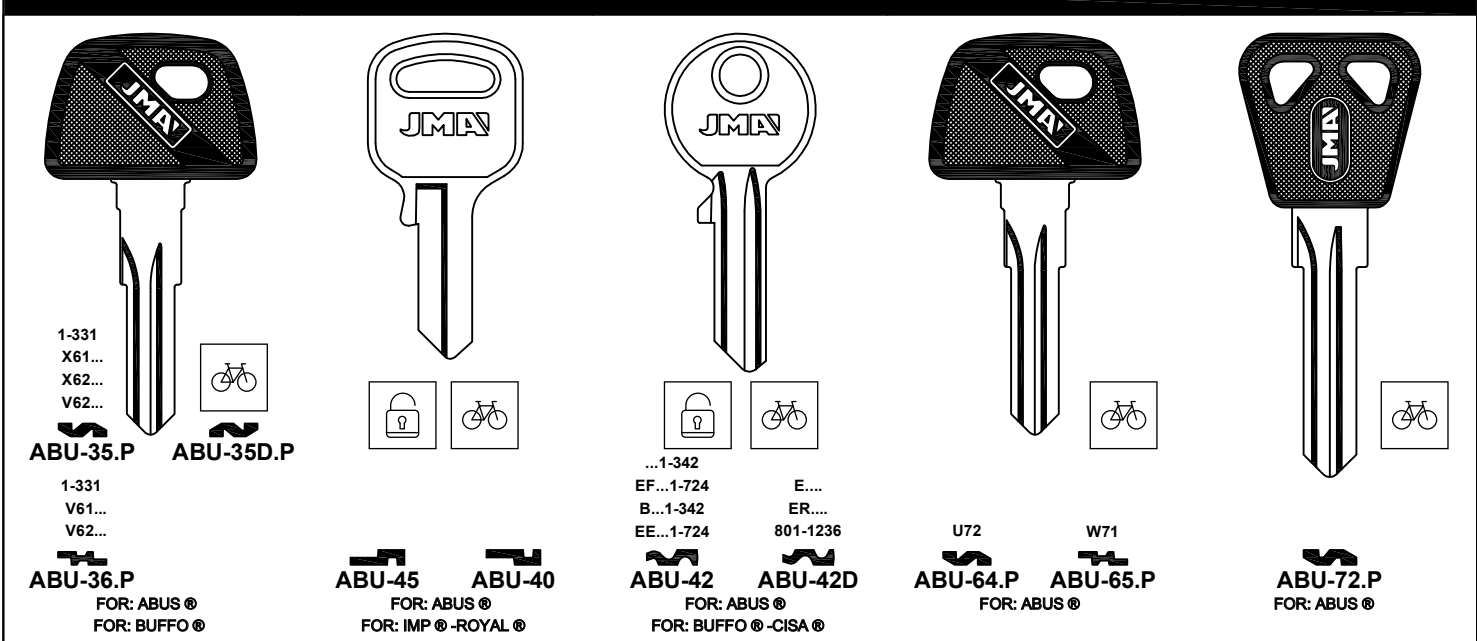
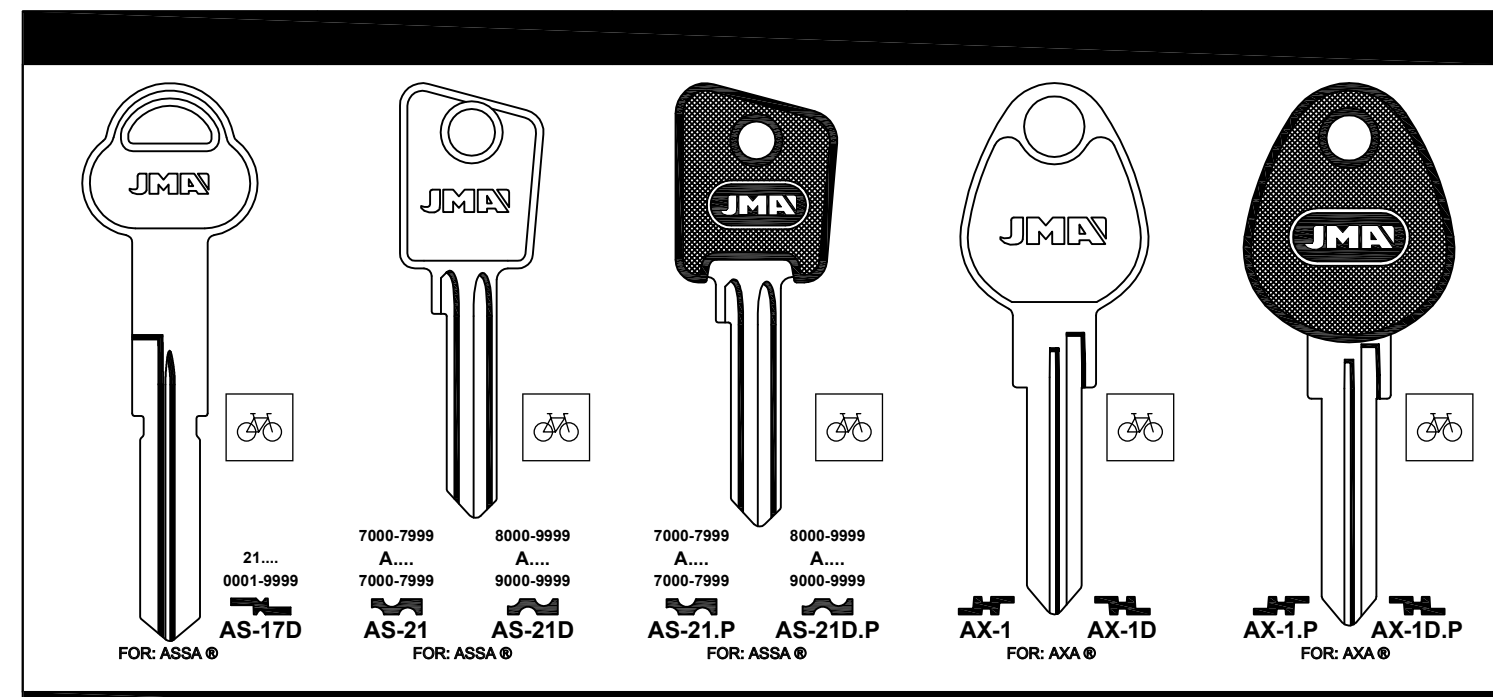
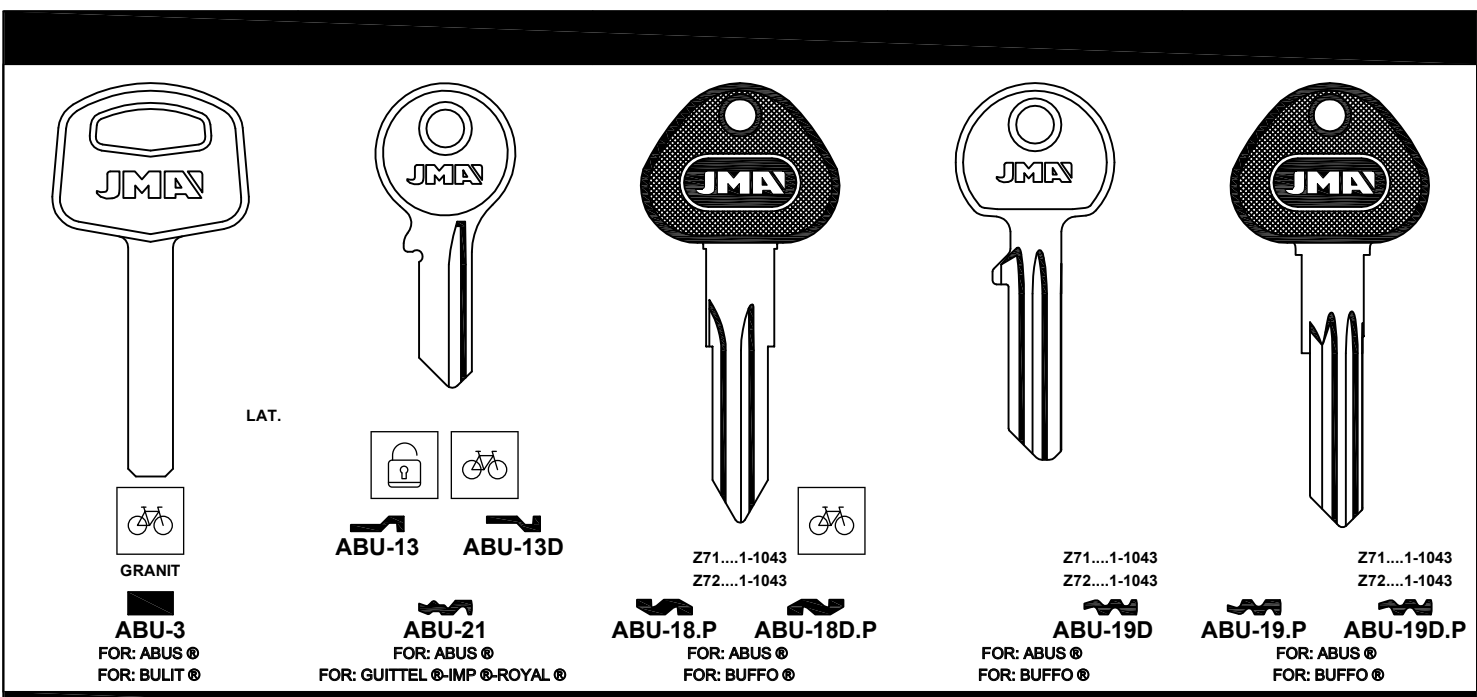

Concerning the marks and commercial denominations see legal warning.  
 Concerniente a las marcas y denominaciones comerciales ver aviso legal.  
 Marka eta izendapen komertzialiei dagokienez, ikus lege-oharra.  
 Concernant les marques et dénominations commerciales voir la note dans l'index.





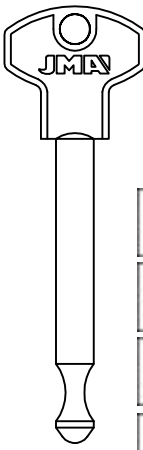
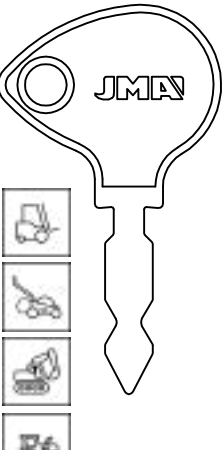
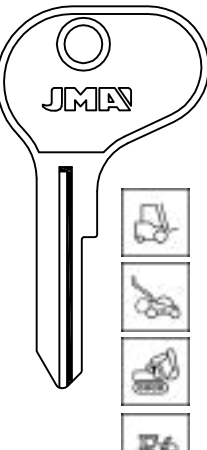
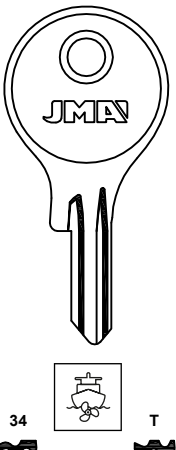
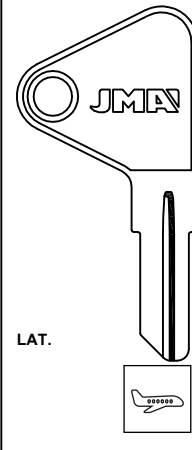
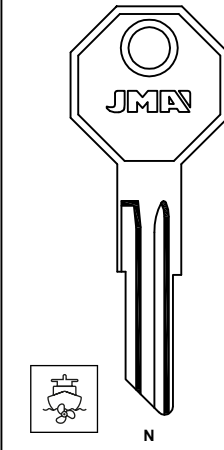

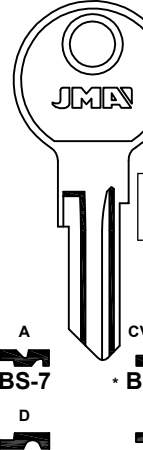
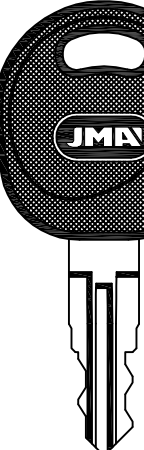
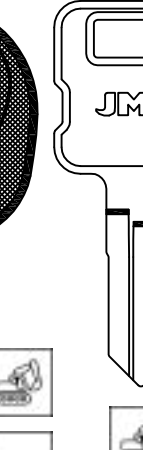
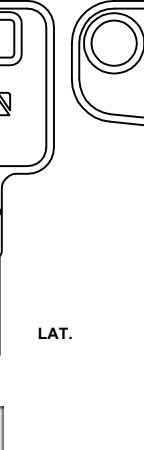
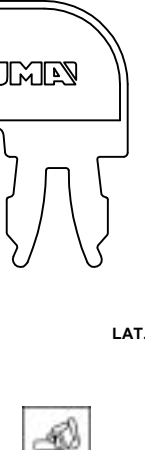
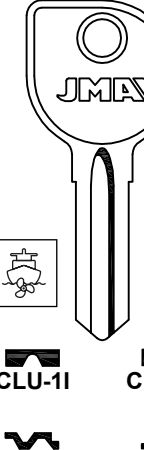

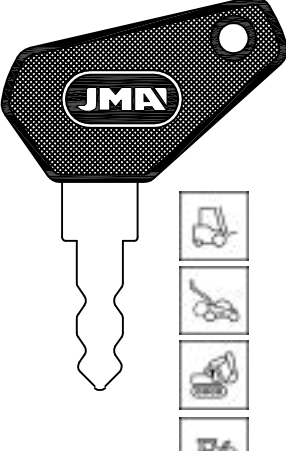
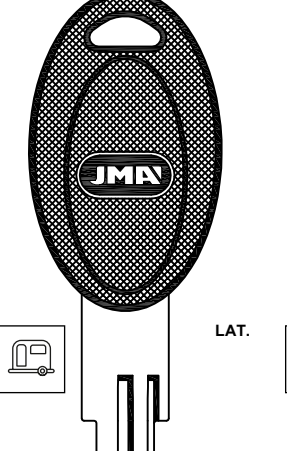
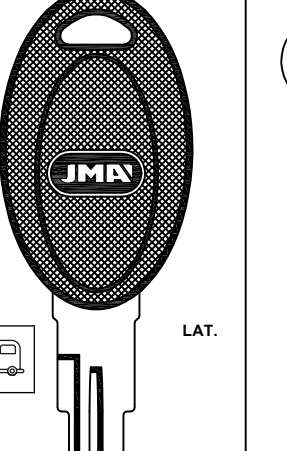
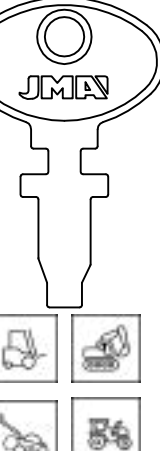
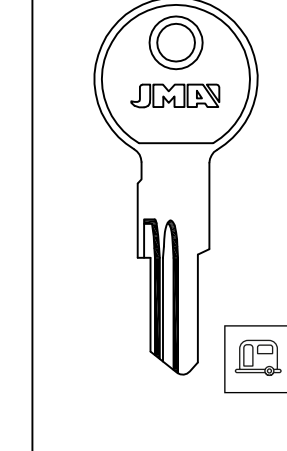
 <p>BH-3</p>	 <p>BH-5</p>	 <p>BH-6</p>	 <p>BK-4</p>	 <p>BK-5D</p>	 <p>BOB-1D</p>
<p>FOR: METEOR® -YALE®</p>		<p>FOR: METEOR® -YALE®</p>		<p>FOR: DEXTER®-POLLAKE®-BOBCAT®</p>	

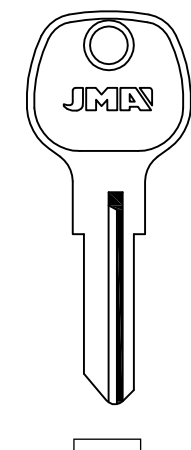
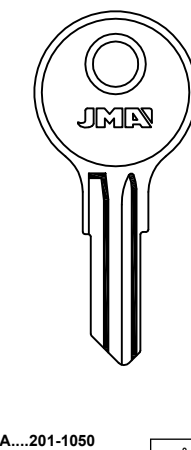
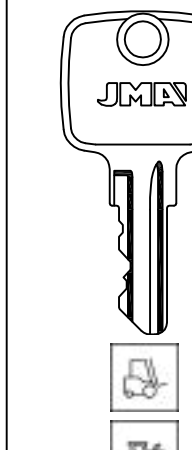
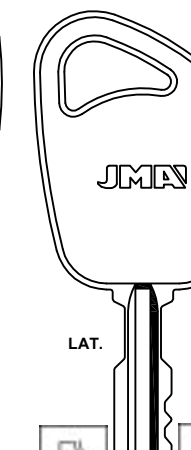
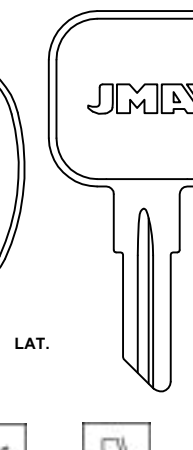
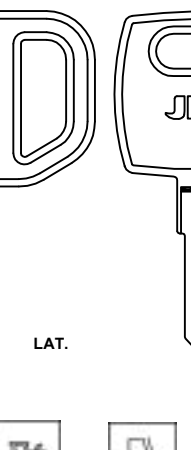
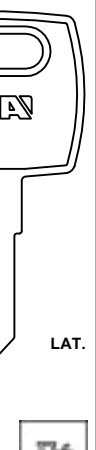
 <p>BS-7</p>	 <p>BS-8</p>	 <p>BS-9</p>	 <p>CAT-1.P</p>	 <p>CAT-2</p>	 <p>CAT-3</p>
<p>FOR: MERCURY®</p>		<p>FOR: DAF®-MACK®-RENAULT SAVIEM®</p>		<p>FOR: DAF®-MACK®-RENAULT SAVIEM®</p>	

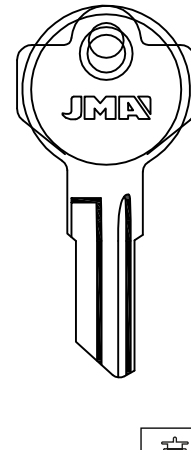
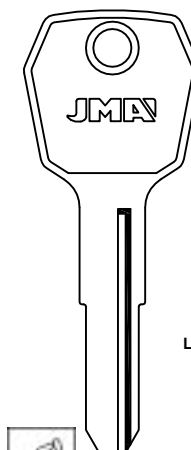
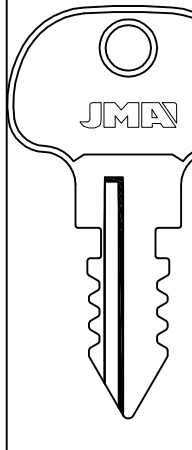
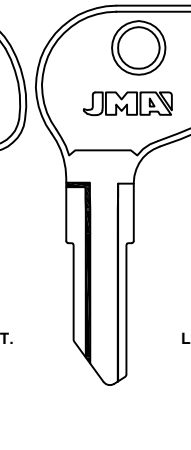
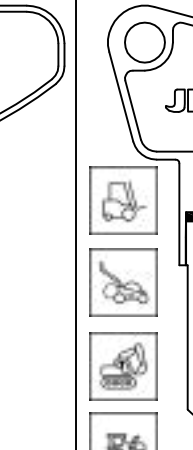
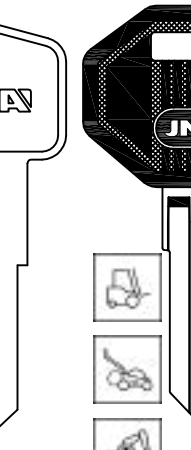
 <p>DAV-1.P</p>	 <p>EU-15.P</p>	 <p>EU-16DP</p>	 <p>FIA-1</p>	 <p>FLO-2D</p>
<p>FOR: HOBBY® -HYMER®</p>		<p>FOR: HOBBY®</p>		<p>FOR: RUNO®</p>

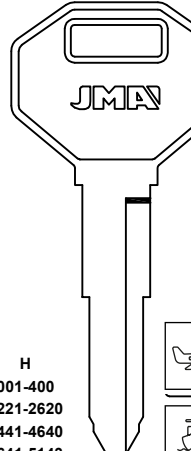
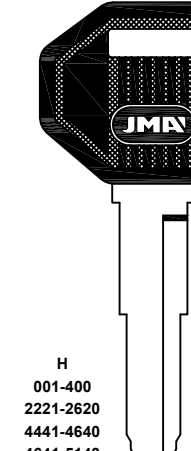
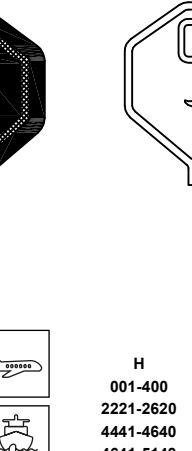
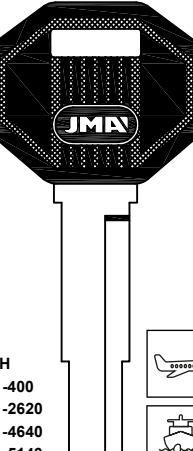
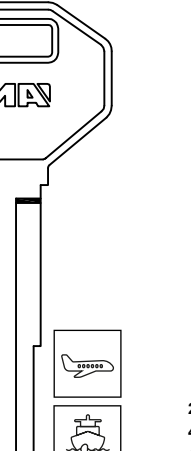
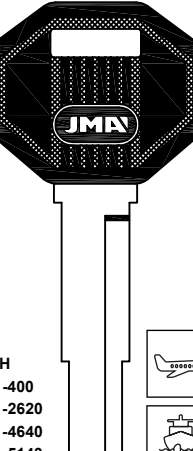
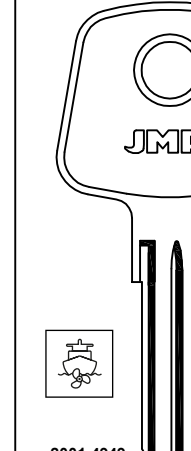
 <p>GH-GX</p>	 <p>GH-HX</p>	 <p>HUD-1</p>	 <p>JD-1</p>	 <p>JD-2</p>	 <p>JD-3D</p>	 <p>JD-4D</p>
<p>FOR: EMKA® -PEROHAUS® FOR: POS® -WECCO®</p>		<p>FOR: DELTA®</p>		<p>FOR: DELTA®</p>		

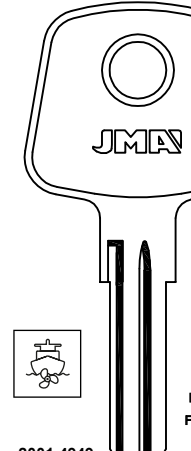
 <p>KEN-1</p>	 <p>KOM-1</p>	 <p>KUB-1D</p>	 <p>KUB-2D</p>	 <p>MERI-1D</p>	 <p>MERI-2D.P</p>
<p>FOR: BASCO®-BRIGGS&amp;STRATTON® FOR: YALE®</p>		<p>FOR: MAHINDRA® -MITSUBISHI®</p>		<p>FOR: MAHINDRA® -MITSUBISHI®</p>	

 <p>MIT-11</p>	 <p>MIT-1D</p>	 <p>MIT-11.P</p>	 <p>MIT-1D.P</p>	 <p>MIT-21</p>	 <p>MIT-2D</p>	 <p>MIT-21.P</p>	 <p>MIT-2D.P</p>	 <p>NE-1</p>	 <p>NE-1D</p>
<p>FOR: CHRYSLER® -HOLDEN® -ISUZU® -MITSUBISHI®</p>		<p>FOR: CHRYSLER® -GM® -HYUNDAI® -ISUZU® FOR: MITSUBISHI® -SUZUKI®</p>		<p>FOR: CHRYSLER® -GM® -HYUNDAI® -ISUZU® FOR: MITSUBISHI® -SUZUKI®</p>		<p>FOR: CLAUSSOR®</p>			

Concerning the marks and commercial denominations see legal warning.  
 Concerniente a las marcas y denominaciones comerciales ver aviso legal.  
 Marka eta izendapen komertzialiei dagokienez, ikus lege-oharra.  
 Concernant les marques et dénominations commerciales voir la note dans l'index.

**JMA** Opening the future

**JMA** Opening the future

Beziehen auf die Marke und Handelsname sehen sie die Notiz im Impressum.  
 Relativamente às marcas e denominações comerciais, ver aviso legal.  
 Jeśli chodzi o znaki i nazwy handlowe, patrz Informacje prawne.





 FOR: AUDI® HONDA® MG® ROVER® BEDFORD® FIAT IVECO® VOLVO® ...2001-4949 GM ...2001-3000 <b>NE-1.P</b> FOR: CLAUSOR®	 FOR: BOMORO® - BOSCH® N....1 AL 5 <b>NE-58D</b>	 FOR: ERINRUDE® <b>PLL-1</b>	 FOR: LAPORTE® 1001-1052 7200-7399 <b>PRE-1</b> FOR: FIAT IVECO® - MAGIRUS DEUTZ®	 FOR: INDAK® 6,2 1.82 <b>TEU-1</b>	 11121-15543 51112-55424 5.... <b>TOYO-25</b>
---	---	------------------------------------	--	--	---

 FOR: HINO® <b>TOYO-27</b>	 LAT. <b>TRM-18D.P</b>	 FOR: TOK® A..... 0 AL 5 <b>WAS-71</b>	 FOR: TOK WINKHAUS® L..... 0 AL 5 <b>WAS-7D</b>	 FOR: TOK WINKHAUS® B..... L..... 0 AL 5 <b>WAS-9</b>	 FOR: TOK WINKHAUS® V..... 1 AL 6 <b>WAS-9D</b>
----------------------------------	------------------------------	--	---	--	---

 V.... 1 AL 6 <b>WST-2D</b>	 FOR: ABUS® BENDIX® CAB® CHICAGO® COLE HERSEE® USA GB ALU. <b>YA-111</b>	 FOR: ABUS® BENDIX® CAB® CHICAGO® COLE HERSEE® USA GB ALU. <b>YA-11D</b>	 FOR: ABUS® BENDIX® CAB® CHICAGO® COLE HERSEE® USA GB ALU. <b>YA-27</b>	 FOR: ABUS® BENDIX® CAB® CHICAGO® COLE HERSEE® USA GB ALU. <b>YA-27D</b>	 FOR: ADEMCO® -BENDIX® -CHICAGO® <b>YA-37</b>	 FOR: ADEMCO® -BENDIX® -CHICAGO® <b>YA-37D</b>	 FOR: FORT® -ILLINOIS® <b>YA-91</b>	 DC...551-952 <b>YA-81</b>	 DC...551-952 <b>YA-8D</b>
--------------------------------------	--	--	---	--	---	--	---	----------------------------------	----------------------------------

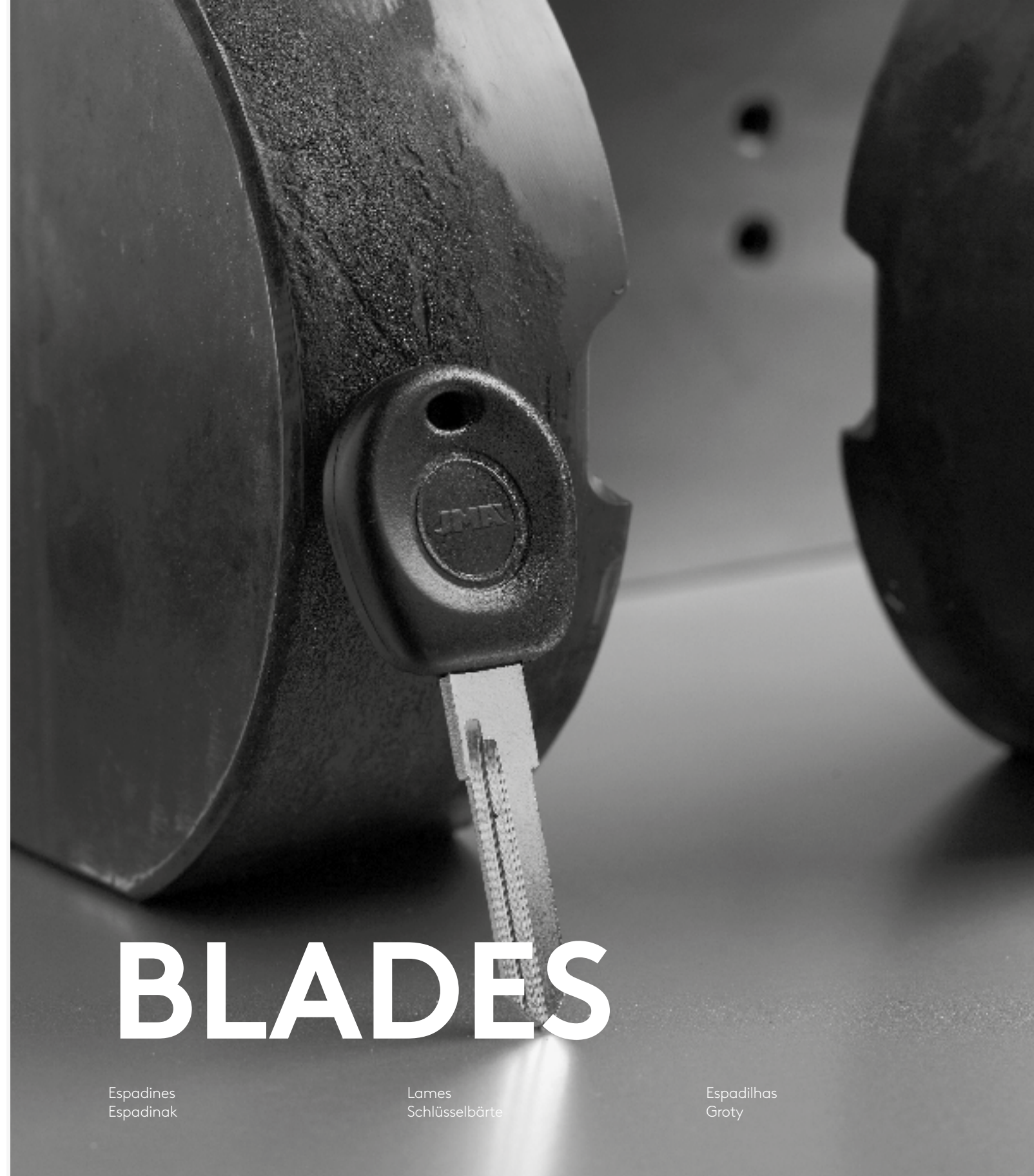

# BLADES

Espadines  
Espadinak

Lames  
Schlüsselbarte

Espadilhas  
Grotty

## VEHICLE KEYS

Llaves de vehículos  
Ibilgailuen giltzak









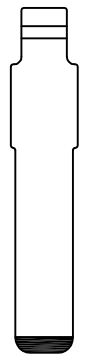

Clés de voitures  
Fahrzeugschlüssel



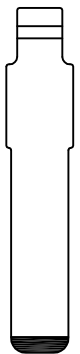



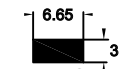

Chaves de automóveis  
Klucze do pojazdów

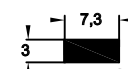







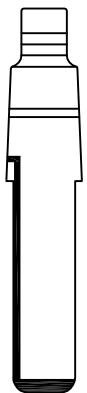

Concerning the marks and commercial denominations see legal warning.  
 Concerniente a las marcas y denominaciones comerciales ver aviso legal.  
 Marka eta izendapen komertzialiei dagokienez, ikus lege-oharra.  
 Concernant les marques et dénominations commerciales voir la note dans l'index.



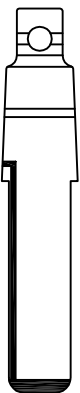

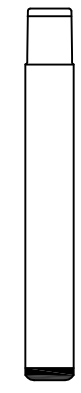

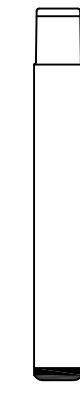
**JMA** Opening the future



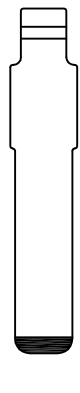
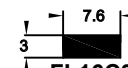
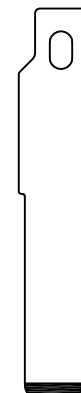

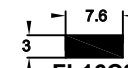

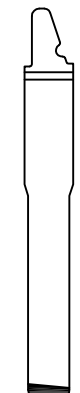



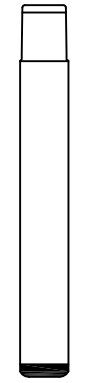

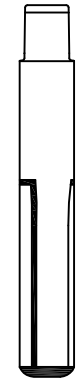

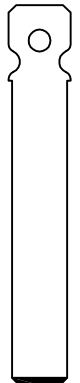



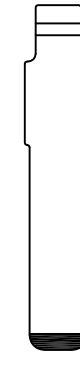

<p><b>FOR: ABARTH®</b></p>  <p>ALP.</p>  <p><b>FI-16C3</b> FOR: TRW-SIPEA®</p>	<p><b>FOR: ALFA ROMEO®</b></p>  <p>ALP.</p>  <p><b>FI-16C1</b> FOR: TRW-SIPEA®</p>	<p><b>FOR: ALFA ROMEO®</b></p>  <p>ALP.</p>  <p><b>FI-16C3</b> FOR: TRW-SIPEA®</p>	<p><b>FOR: ASTON MARTIN®</b></p>  <p>ALP.</p> <p>H.... WH.... 0001-3000</p>  <p><b>OP-WHC1</b> FOR: HUF®</p>	<p><b>FOR: AUDI®</b></p>  <p>ALP.</p>  <p><b>HU-7C1</b></p>  <p><b>HU-4C1</b> FOR: HUF®</p>
--	--	--	--	--

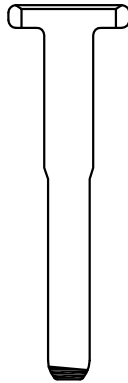
<p><b>FOR: CITROEN®</b></p>  <p>ALP.</p>  <p><b>PEU-1C1</b> FOR: U-SHIN®</p>	<p><b>FOR: DACIA®</b></p>  <p>ALP.</p>  <p><b>DAC-3DC1</b> FOR: DACIA®</p>				<p><b>FOR: DACIA®</b></p>  <p>ALP.</p>  <p><b>DAC-4DC1</b> FOR: DACIA® FOR: HUF®</p>	<p><b>FOR: DACIA®</b></p>  <p>ALP.</p>  <p><b>DAC-5C1</b> FOR: DACIA® FOR: U-SHIN®</p>	<p><b>FOR: DACIA®</b></p>  <p>ALP.</p>  <p><b>DAC-6DC1</b> FOR: DACIA® FOR: HUF®</p>
--	--	--	--	--	--	--	--

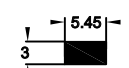
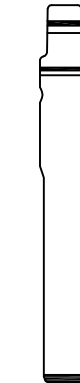
<p><b>FOR: AUDI®</b></p>  <p>ALP.</p>  <p><b>HU-HAAC1</b> FOR: HUF®</p>			<p><b>FOR: BUICK®</b></p>  <p>ALP.</p>  <p><b>HU-NAAC2</b> FOR: HUF®</p>	<p><b>FOR: BUICK®</b></p>  <p>ALP.</p>  <p><b>HU-HAAC3</b> FOR: U-SHIN®</p>	<p><b>FOR: BUICK®</b></p>  <p>ALP.</p> <p>Z....1-2000 Z....2001-4000 Z....4001-6000</p>  <p><b>OP-11C1</b> FOR: HUF®</p>	<p><b>FOR: CADILLAC®</b></p>  <p>ALP.</p> <p>Z....1-2000 Z....2001-4000 Z....4001-6000</p>  <p><b>OP-11C1</b> FOR: HUF®</p>
--	--	--	---	--	---	--





<p><b>FOR: FERRARI®</b></p>  <p>ALP.</p>  <p><b>FI-16C3</b> FOR: TRW-SIPEA®</p>	<p><b>FOR: FIAT®</b></p>  <p>ALP.</p>  <p><b>FI-16C1</b> FOR: TRW-SIPEA®</p>		<p><b>FOR: FIAT®</b></p>  <p>ALP.</p>  <p><b>FI-16C3</b> FOR: TRW-SIPEA®</p>	<p><b>FOR: FORD®</b></p>  <p>ALP.</p> <p>....1-4000</p>  <p><b>FO-24C1</b> FOR: HUF®</p>		<p><b>FOR: FORD®</b></p>  <p>ALP.</p> <p>....1-4000</p>  <p><b>FO-24C2</b> FOR: HUF®</p>
--	---	--	---	---	--	---

<p><b>FOR: CHEVROLET®</b></p>  <p>ALP.</p> <p>Z....1-2000 Z....2001-4000 Z....4001-6000</p>  <p><b>OP-11C1</b> FOR: HUF®</p>	<p><b>FOR: CHEVROLET®</b></p>  <p>ALP.</p> <p>H.... WH.... 0001-3000</p>  <p><b>OP-WHC1</b> FOR: HUF®</p>	<p><b>FOR: CITROEN®</b></p>  <p>ALP.</p> <p>.....1-2-3-4-Q-5-6-7-8-H .....A-B-C-D-E-F</p>  <p><b>CIT-1C1</b> FOR: U-SHIN®</p>		<p><b>FOR: CITROEN®</b></p>  <p>ALP.</p>  <p><b>FI-16C1</b> FOR: TRW-SIPEA®</p>	<p><b>FOR: CITROEN®</b></p>  <p>ALP.</p>  <p><b>FI-16C3</b> FOR: TRW-SIPEA®</p>
--	---	---	--	---	---





<p><b>FOR: FORD®</b></p>  <p>ALP.</p> <p>....1-4000</p>  <p><b>FO-24C3</b> FOR: HUF®</p>			<p><b>FOR: FORD®</b></p>  <p>ALP.</p> <p>....1-4000</p>  <p><b>FO-24C8</b> FOR: HUF®</p>	<p><b>FOR: FORD®</b></p>  <p>ALP.</p> <p>....1-4000</p>  <p><b>FO-24C9</b> FOR: HUF® FOR: WITTE®</p>	<p><b>FOR: GMC®</b></p>  <p>ALP.</p> <p>Z....1-2000 Z....2001-4000 Z....4001-6000</p>  <p><b>OP-11C1</b> FOR: HUF®</p>	<p><b>FOR: HOLDEN®</b></p>  <p>ALP.</p> <p>Z....1-2000 Z....2001-4000 Z....4001-6000</p>  <p><b>OP-11C1</b> FOR: HUF®</p>
--	--	--	--	--	--	---





Concerning the marks and commercial denominations see legal warning.  
 Concerniente a las marcas y denominaciones comerciales ver aviso legal.  
 Marka eta izendapen komertzialiei dagokienez, ikus lege-oharra.  
 Concernant les marques et dénominations commerciales voir la note dans l'index.



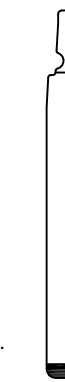



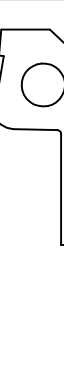

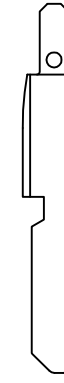

<p><b>FOR: HOLDEN ®</b></p>  <p>ALP.</p> <p>H.... WH.... 0001-3000</p> <p><b>OP-WHC1</b> FOR: HUF ®</p>	<p><b>FOR: LANCIA ®</b></p>  <p>ALP.</p> <p><b>FI-16C1</b> FOR: TRW-SIPEA ®</p>  <p>ALP.</p> <p>7.6 3</p> <p><b>FI-16C3</b> FOR: TRW-SIPEA ®</p>	<p><b>FOR: NISSAN ®</b></p>  <p>ALP.</p> <p>.....1-22185</p> <p><b>DAT-15C1</b> FOR: NISSAN ® FOR: VALEO ®</p>  <p>ALP.</p> <p>.....1-22185</p> <p><b>DAT-15C2</b> FOR: NISSAN ® FOR: VALEO ®</p>
--	--	--



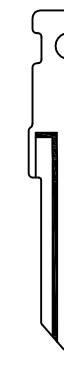

**FOR: OPEL-VAUXHALL ®**

 <p>ALP.</p> <p><b>DAC-5C1</b> FOR: DACIA ® FOR: U-SHIN ®</p>	 <p>ALP.</p> <p>.....1/9.... 1/9....A/Z 1/9....A/Z 1/9....A/Z 1/9....A/Z 1/9....A/Z 1/9....A/Z 1/9....A/Z A/Z 1/9....A/Z M-N-P-R-S</p> <p><b>NE-60C1</b> FOR: NEIMAN ®</p>	 <p>ALP.</p> <p>.....1/9.... 1/9....A/Z 1/9....A/Z 1/9....A/Z 1/9....A/Z 1/9....A/Z 1/9....A/Z 1/9....A/Z A/Z 1/9....A/Z M-N-P-R-S</p> <p><b>NE-60C3</b> FOR: NEIMAN ®</p>	 <p>ALP.</p> <p>Z....1-2000 Z....2001-4000 Z....4001-6000</p> <p><b>OP-11C1</b> FOR: HUF ®</p>	 <p>ALP.</p> <p>.....0001-3679 Z....1-2000 Z....2001-4000 Z....4001-6314</p> <p>6.4 3</p> <p><b>OP-11C3</b> FOR: HUF ®</p>
---	--	--	---	--

<p><b>FOR: OPEL-VAUXHALL ®</b></p>  <p>ALP.</p> <p>H.... WH.... 0001-3000</p> <p><b>OP-WHC1</b> FOR: HUF ®</p>	<p><b>FOR: PEUGEOT ®</b></p>  <p>ALP.</p> <p>.....1-2-3-4-Q-5-6-7-8-H .....A-B-C-D-E-F</p> <p>7.3 3</p> <p><b>CIT-1C1</b> FOR: U-SHIN ®</p>  <p>ALP.</p> <p>.....1/9.... 1/9....A/Z 1/9....A/Z 1/9....A/Z 1/9....A/Z 1/9....A/Z 1/9....A/Z 1/9....A/Z A/Z 1/9....A/Z M-N-P-R-S</p> <p><b>NE-60C2</b> FOR: NEIMAN ®</p>	 <p>ALP.</p> <p>.....1/9.... 1/9....A/Z 1/9....A/Z 1/9....A/Z 1/9....A/Z 1/9....A/Z 1/9....A/Z 1/9....A/Z A/Z 1/9....A/Z M-N-P-R-S</p> <p><b>NE-60C3</b> FOR: NEIMAN ®</p>	 <p>ALP.</p> <p>7.3 3</p> <p><b>PEU-1C1</b> FOR: U-SHIN ®</p>
---	--	---	--

<p><b>FOR: PEUGEOT ®</b></p>  <p>ALP.</p> <p><b>PEU-2C1</b> FOR: U-SHIN ®</p>	<p><b>FOR: RENAULT ®</b></p>  <p>ALP.</p> <p>.....1/9.... 1/9....A/Z 1/9....A/Z 1/9....A/Z 1/9....A/Z 1/9....A/Z 1/9....A/Z 1/9....A/Z A/Z 1/9....A/Z M-N-P-R-S</p> <p><b>NE-60C2</b> FOR: NEIMAN ®</p>  <p>ALP.</p> <p>.....1/9.... 1/9....A/Z 1/9....A/Z 1/9....A/Z 1/9....A/Z 1/9....A/Z 1/9....A/Z 1/9....A/Z A/Z 1/9....A/Z M-N-P-R-S</p> <p><b>NE-60C3</b> FOR: NEIMAN ®</p>	 <p>ALP.</p> <p>.....A/Z 0/9 1-4092 .....A/Z 0/9 5001-9092 .....A/Z 0/9 1-4092 .....A/Z 0/9 5001-9092</p> <p><b>VA-61C1</b> FOR: VACHETTE ®</p>	 <p>ALP.</p> <p>.....A/Z 0/9 1-4092 .....A/Z 0/9 5001-9092 .....A/Z 0/9 1-4092 .....A/Z 0/9 5001-9092</p> <p><b>VA-61C2</b> FOR: VACHETTE ®</p>
--	--	--	--

<p><b>FOR: RENAULT ®</b></p>  <p>ALP.</p> <p>.....A/Z 0/9 1-4092 .....A/Z 0/9 5001-9092 .....A/Z 0/9 1-4092 .....A/Z 0/9 5001-9092</p> <p><b>VA-61C3</b> FOR: VACHETTE ®</p>	<p><b>FOR: RENAULT DACIA ®</b></p>  <p>ALP.</p> <p><b>DAC-7DC1</b> FOR: DACIA ®</p>  <p>ALP.</p> <p><b>DAC-3DC1</b> FOR: DACIA ®</p> <p><b>DAC-4DC1</b> FOR: DACIA ®</p> <p><b>DAC-6DC1</b> FOR: DACIA ®</p>	<p><b>FOR: SEAT ®</b></p>  <p>ALP.</p> <p><b>HU-7C1</b> FOR: HUF ®</p> <p>6.65 3</p> <p><b>HU-4C1</b> FOR: HUF ®</p>
--	--	--



<p><b>FOR: SKODA ®</b></p>  <p>ALP.</p> <p><b>HU-7C1</b> FOR: HUF ®</p> <p>6.65 3</p> <p><b>HU-4C1</b> FOR: HUF ®</p>	<p><b>FOR: SUBARU ®</b></p>  <p>ALP.</p> <p><b>HU-HAAC1</b> FOR: HUF ®</p>  <p>ALP.</p> <p><b>HU-HAAC2</b> FOR: HUF ®</p>	<p><b>FOR: OPEL-VAUXHALL ®</b></p>  <p>ALP.</p> <p>X....1-9000</p> <p><b>DAT-6C1</b> FOR: NISSAN ® FOR: VALEO ®</p>	<p><b>FOR: PEUGEOT ®</b></p>  <p>ALP.</p> <p>.....1-22185</p> <p><b>DAT-15C1</b> FOR: NISSAN ® FOR: VALEO ®</p>
--	---	--	--

Concerning the marks and commercial denominations see legal warning.  
 Concerniente a las marcas y denominaciones comerciales ver aviso legal.  
 Marka eta izendapen komertzialiei dagokienez, ikus lege-oharra.  
 Concernant les marques et dénominations commerciales voir la note dans l'index.

**JMA** Opening the future

**JMA** Opening the future

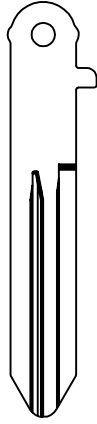
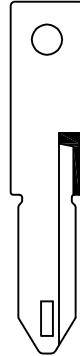
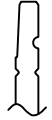
Beziehen auf die Marke und Handelsname sehen sie die Notiz im Impressum.  
 Relativamente às marcas e denominações comerciais, ver aviso legal.  
 Jeśli chodzi o znaki i nazwy handlowe, patrz Informacje prawne.

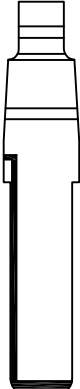
FOR: SUBARU ®	FOR: VARIOUS ®	FOR: VOLKSWAGEN ®			
					
.....1-22185 <b>DAT-15C2</b> FOR: NISSAN ® FOR: VALEO ®	..1/9.... 1/9....A/Z ..1/9....A/Z ...1/9...A/Z ....1/9...A/Z .....1/9...A/Z .....1/9...A/Z A/Z .....1/9...A/Z M-N-P-R-S <b>NE-60C1</b> FOR: NEIMAN ®	<b>HU-7C1</b> ALP.	<b>HU-4C1</b> FOR: HUF ®	<b>HU-HAAC1</b> FOR: HUF ®	<b>HU-HAAC2</b> ALP. <b>HU-NAAC2</b> FOR: HUF ®

**FOR: VOLKSWAGEN ®**

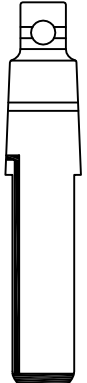
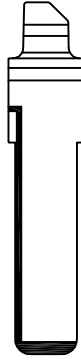
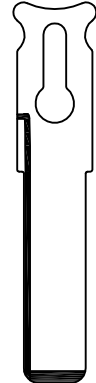
		
ALP.	ALP.	
<b>HU-HAAC3</b> FOR: U-SHIN ®	<b>HU-HAAC4</b> FOR: U-SHIN ®	<b>HU-HAAC5</b> FOR: HUF ®



# KRC

## VEHICLE KEYS



Llaves de vehículos  
Ibilgailuen giltzak





Clés de voitures  
Fahrzeugschlüssel

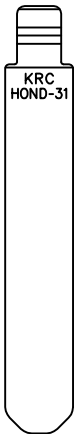
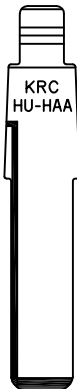

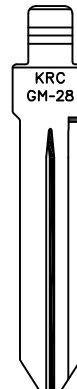

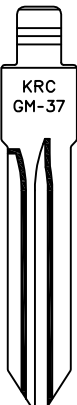
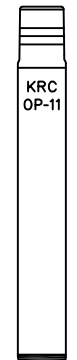
Chaves de automóveis  
Klucze do pojazdów

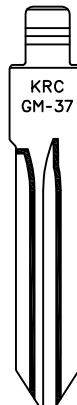



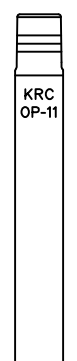

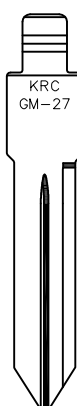
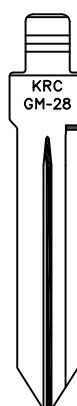



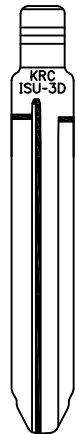
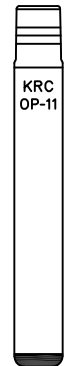

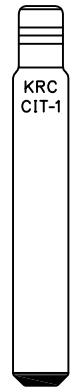
<p><b>FOR: ACURA (USA)®</b></p>  <p>LAT.</p> <p>...K001-N718</p> <p><b>KRCHOND-31</b> FOR: HONDA®</p>	<p><b>FOR: AUDI (USA)®</b></p>  <p>LAT.</p> <p><b>KRCHU-HAA</b> FOR: HUF®</p>	<p><b>FOR: AUDI®</b></p>  <p>LAT.</p> <p><b>KRCHU-HAA</b> FOR: HUF®</p>	<p><b>FOR: BUICK®</b></p>  <p>LAT.</p> <p>H... 1-3988</p> <p><b>KRCGM-27</b> FOR: GENERAL MOTORS®</p>	<p><b>FOR: BUICK®</b></p>  <p>LAT.</p> <p>H... 1-3988</p> <p><b>KRCGM-28</b> FOR: GENERAL MOTORS®</p>
--	--	--	---	--

<p><b>FOR: BUICK®</b></p>  <p>LAT.</p> <p><b>KRCGM-37</b> FOR: GENERAL MOTORS®</p>	<p><b>FOR: CADILLAC®</b></p>  <p>LAT.</p> <p>Z... 1-2000 2001-4000 4001-6000</p> <p><b>KRCOP-11</b> FOR: HUF®</p>	<p><b>FOR: CADILLAC®</b></p>  <p>LAT.</p> <p>H... 1-3988</p> <p><b>KRCGM-28</b> FOR: GENERAL MOTORS®</p>	<p><b>FOR: CHEVROLET®</b></p>  <p>LAT.</p> <p><b>KRCGM-37</b> FOR: GENERAL MOTORS®</p>	<p><b>FOR: CHEVROLET®</b></p>  <p>LAT.</p> <p>T-V... 1-1200</p> <p><b>KRCDAE-4</b> FOR: DAEWOO®</p>
--	---	--	---	---

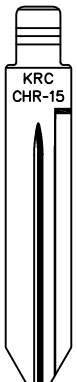
<p><b>FOR: CHEVROLET®</b></p>  <p>LAT.</p> <p>Z... 1-2000 2001-4000 4001-6000</p> <p><b>KRCOP-11</b> FOR: HUF®</p>	<p><b>FOR: CHEVROLET (USA)®</b></p>  <p>LAT.</p> <p>T-V... 1-1200</p> <p><b>KRCDAE-4</b> FOR: DAEWOO®</p>	<p><b>FOR: CHEVROLET (USA)®</b></p>  <p>LAT.</p> <p>H... 1-3988</p> <p><b>KRCGM-27</b> FOR: GENERAL MOTORS®</p>	<p><b>FOR: CHEVROLET (USA)®</b></p>  <p>LAT.</p> <p>H... 1-3988</p> <p><b>KRCGM-28</b> FOR: GENERAL MOTORS®</p>	<p><b>FOR: CHEVROLET (USA)®</b></p>  <p>LAT.</p> <p><b>KRCGM-37</b> FOR: GENERAL MOTORS®</p>
---	--	--	---	---

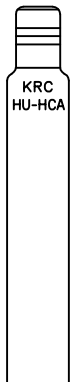
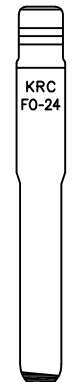
<p><b>FOR: CHEVROLET (USA)®</b></p>  <p>LAT.</p> <p><b>KRCISU-3D</b> FOR: ISUZU®</p>	<p><b>FOR: CHEVROLET (USA)®</b></p>  <p>LAT.</p> <p>Z... 1-2000 2001-4000 4001-6000</p> <p><b>KRCOP-11</b> FOR: HUF®</p>	<p><b>FOR: CHRYSLER®</b></p>  <p>LAT.</p> <p>L... 1-3580</p> <p><b>KRCCHR-15</b> FOR: CHRYSLER®</p>	<p><b>FOR: CHRYSLER (USA)®</b></p>  <p>LAT.</p> <p>L... 1-3580</p> <p><b>KRCCHR-15</b> FOR: CHRYSLER®</p>	<p><b>FOR: CITROEN®</b></p>  <p>LAT.</p> <p>.....1-2-3-4-Q-5-6-7-8-H .....A-B-C-D-E-F</p> <p><b>KRCCIT-1</b> FOR: USHIN®</p>
---	---	--	--	---

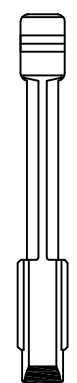
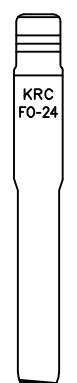
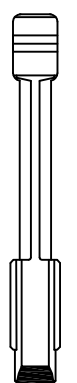
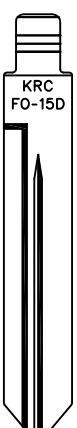







<p><b>FOR: CITROEN®</b></p>  <p>LAT.</p> <p><b>KRCHU-HCA</b> FOR: HUF®</p>	<p><b>FOR: DODGE®</b></p>  <p>LAT.</p> <p>L... 1-3580</p> <p><b>KRCCHR-15</b> FOR: CHRYSLER®</p>	<p><b>FOR: DS®</b></p>  <p>LAT.</p> <p>.....1-2-3-4-Q-5-6-7-8-H .....A-B-C-D-E-F</p> <p><b>KRCCIT-1</b> FOR: USHIN®</p>	<p><b>FOR: FIAT®</b></p>  <p>LAT.</p> <p><b>KRCHU-HCA</b> FOR: HUF®</p>	<p><b>FOR: FORD®</b></p>  <p>LAT.</p> <p>.....1-4000</p> <p><b>KRCFO-24</b> FOR: HUF®</p>
--	--	---	---	---

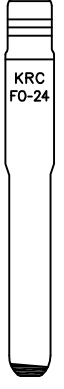
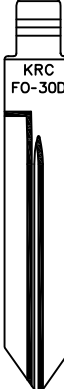

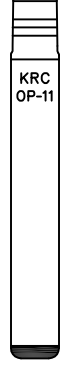





<p><b>FOR: FORD®</b></p>  <p>LAT.</p> <p>T... 1 AL 4 001-1050</p> <p><b>KRCFO-6</b> FOR: HUF®</p>	<p><b>FOR: FORD (AUS)®</b></p>  <p>LAT.</p> <p>.....1-4000</p> <p><b>KRCFO-24</b> FOR: HUF®</p>	<p><b>FOR: FORD (AUS)®</b></p>  <p>LAT.</p> <p>T... 1 AL 4 001-1050</p> <p><b>KRCFO-6</b> FOR: HUF®</p>	<p><b>FOR: FORD (USA)®</b></p>  <p>LAT.</p> <p>.....X 0001-1706</p> <p><b>KRCFO-15D</b> FOR: FORD®</p>	<p><b>FOR: FORD (USA)®</b></p>  <p>LAT.</p> <p>...A... 101-291 501-579 ...B... 101-332 501-602 ...C... 101-344 501-624 ...D... 101-327 501-602 ...E... 101-296 501-579</p> <p><b>KRCFO-16</b> FOR: FORD®</p>
--	--	--	---	---

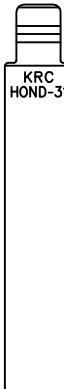
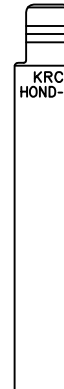







Concerning the marks and commercial denominations see legal warning.  
 Concerniente a las marcas y denominaciones comerciales ver aviso legal.  
 Marka eta izendapen komertzialiei dagokienez, ikus lege-oharra.  
 Concernant les marques et dénominations commerciales voir la note dans l'index.

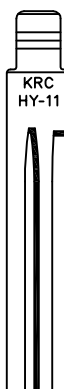











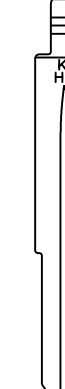
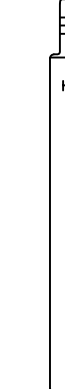
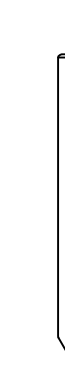





Beziehen auf die Marke und Handelsname sehen sie die Notiz im Impressum.  
 Relativamente às marcas e denominações comerciais, ver aviso legal.  
 Jeśli chodzi o znaki i nazwy handlowe, patrz Informacje prawne.

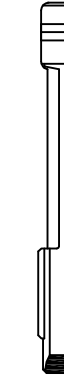

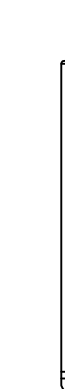





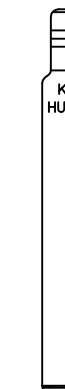

FOR: FORD (USA)®		FOR: GMC®		
 LAT.	 LAT.	 LAT.	 LAT.	 LAT.
...1-4000  KRCFO-24 FOR: HUF®	 KRCFO-30D FOR: FORD®	 KRCGM-37 FOR: GENERAL MOTORS®	 KRCISU-3D FOR: ISUZU®	Z... 1-2000 2001-4000 4001-6000  KRCOP-11 FOR: HUF®

FOR: HOLDEN®	FOR: HONDA®	FOR:HONDA(AUS)®	FOR: HONDA (USA)®	
 LAT.	 LAT.	 LAT.	 LAT.	 LAT.
S... 0001-5200  KRCOP-S FOR: HUF® FOR: YMOS®	...K001-N718  KRCHOND-31 FOR: HONDA®	...K001-N718  KRCHOND-31 FOR: HONDA®	5001-8442  KRCHOND-21 FOR: HONDA®	...K001-N718  KRCHOND-31 FOR: HONDA®

FOR: HUMMER®	FOR: HYUNDAI®			
 LAT.	 LAT.	 LAT.	 LAT.	 LAT.
 KRCGM-37 FOR: GENERAL MOTORS®	H...0001-2500 M...0001-2500 P...0001-2500 T...0001-2500 V...1-2500  KRCHY-11 FOR: HYUNDAI® FOR: KIA®	T 0001-1000  KRCHY-4 FOR: HYUNDAI® FOR: KIA®	S... 1-1000  KRCHY-6D FOR: HYUNDAI®	K...0001-2500 P...0001-2500  KRCKI-7 FOR: KIA®









FOR: HYUNDAI®	FOR: HYUNDAI (AUS)®		FOR: HYUNDAI (USA)®	FOR: INFINITI (USA)®
 LAT.	 LAT.	 LAT.	 LAT.	 LAT.
...1-5000  KRCTOYO-18 FOR: TOYOTA®	H...0001-2500 M...0001-2500 P...0001-2500 T...0001-2500 V...1-2500  KRCHY-11 FOR: HYUNDAI® FOR: KIA®	T 0001-1000  KRCHY-4 FOR: HYUNDAI® FOR: KIA®	H...0001-2500 M...0001-2500 P...0001-2500 T...0001-2500 V...1-2500  KRCHY-11 FOR: HYUNDAI® FOR: KIA®	...1-22185  KRCDAT-15 FOR: NISSAN® FOR: USHIN®

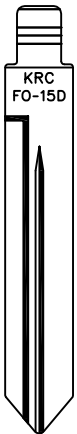
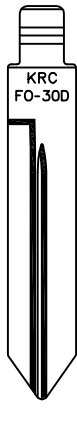
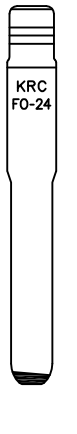

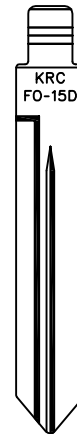





FOR: ISUZU (USA)®	FOR: JAGUAR (USA)®	FOR: JAGUAR®	FOR: JEEP®	FOR: KIA®
 LAT.	 LAT.	 LAT.	 LAT.	 LAT.
 KRCISU-3D FOR: ISUZU®	T... 1 AL 4 001-1050  KRCFO-6 FOR: HUF® FOR: TIBBE®	T... 1 AL 4 001-1050  KRCFO-6 FOR: HUF® FOR: TIBBE®	L... 1-3580  KRCCHR-15 FOR: CHRYSLER®	K...0001-2500 P...0001-2500  KRCKI-7 FOR: KIA®

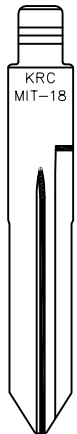

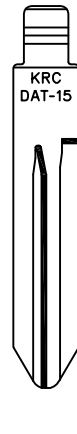
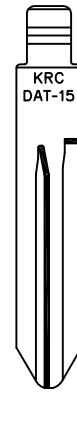
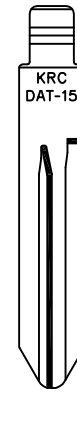





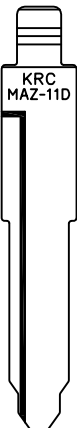

FOR: KIA (USA)®		FOR: LANCIA®	FOR:LEXUS (USA)®	FOR: LEXUS®
 LAT.	 LAT.	 LAT.	 LAT.	 LAT.
M...1-2500 T...1-2500 WC...1001-3500  KRCHY-11D FOR: HYUNDAI®	T 0001-1000  KRCHY-4 FOR: HYUNDAI® FOR: KIA®	 KRCHU-HCA FOR: HUF®	 KRCTOYO-30 FOR: TOYOTA®	 KRCTOYO-30 FOR: TOYOTA®



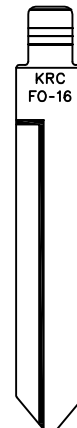





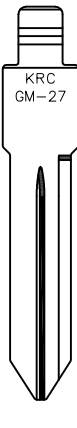

Concerning the marks and commercial denominations see legal warning.  
 Concerniente a las marcas y denominaciones comerciales ver aviso legal.  
 Marka eta izendapen komertzialiei dagokienez, ikus lege-oharra.  
 Concernant les marques et dénominations commerciales voir la note dans l'index.











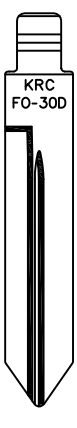

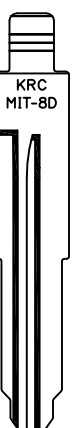





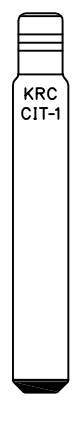

FOR: LINCOLN®		FOR: MAZDA®		FOR: MAZDA (AUS)®	
					
LAT.	LAT.	LAT.	LAT.	LAT.	
...X 0001-1706		...1-4000	... 10100-12099 20100-23284	...X 0001-1706	
 <b>KRCFO-15D</b> FOR: FORD®	 <b>KRCFO-30D</b> FOR: FORD®	 <b>KRCFO-24</b> FOR: HUF®	 <b>KRCMAZ-11D</b> FOR: MAZDA®	 <b>KRCFO-15D</b> FOR: FORD®	

FOR: MITSUBISHI (USA)®		FOR: NISSAN®	FOR: NISSAN (AUS)®	FOR: NISSAN (USA)®
				
LAT.	LAT.	LAT.	LAT.	LAT.
F...1-1571	30010-32009	...1-22185	...1-22185	...1-22185
 <b>KRCMIT-18</b> FOR: MITSUBISHI®	 <b>KRCMIT-8D</b> FOR: MITSUBISHI®	 <b>KRCDAT-15</b> FOR: NISSAN® FOR: USHIN®	 <b>KRCDAT-15</b> FOR: NISSAN® FOR: USHIN®	 <b>KRCDAT-15</b> FOR: NISSAN® FOR: USHIN®

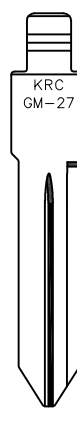
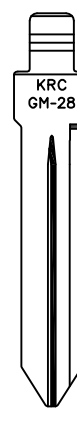
FOR: MAZDA (AUS)®	FOR: MAZDA (USA)®		FOR: MERCURY®	
				
LAT.	LAT.	LAT.	LAT.	LAT.
... 10100-12099 20100-23284	...X 0001-1706	... 10100-12099 20100-23284	...A... 101-291 501-579 ...B... 101-332 501-602 ...C... 101-344 501-624 ...D... 101-327 501-602 ...E... 101-296 501-579	...X 0001-1706
 <b>KRCMAZ-11D</b> FOR: MAZDA®	 <b>KRCFO-15D</b> FOR: FORD®	 <b>KRCMAZ-11D</b> FOR: MAZDA®	 <b>KRCFO-15D</b> FOR: FORD®	 <b>KRCFO-16</b> FOR: FORD®

FOR: OLDS MOBILE®		FOR: OPEL-VAUXHALL®		
				
LAT.	LAT.	LAT.	LAT.	LAT.
H... 1-3988	H... 1-3988	T-V... 1-1200	Z... 1-2000 2001-4000 4001-6000	S... 0001-5200
 <b>KRCGM-27</b> FOR: GENERAL MOTORS®	 <b>KRCGM-28</b> FOR: GENERAL MOTORS®	 <b>KRCDAE-4</b> FOR: DAEWOO®	 <b>KRCOP-11</b> FOR: HUF®	 <b>KRCOP-S</b> FOR: HUF® FOR: YMOS®

FOR: MERCURY®	FOR: MITSUBISHI®		FOR: MITSUBISHI (AUS)®	FOR: MITSUBISHI (USA)®
				
LAT.	LAT.	LAT.	LAT.	LAT.
	E 5001-7679 7001-7700	30010-32009	E 5001-7679 7001-7700	E 5001-7679 7001-7700
 <b>KRCFO-30D</b> FOR: FORD®	 <b>KRCMIT-12</b> FOR: MITSUBISHI®	 <b>KRCMIT-8D</b> FOR: MITSUBISHI®	 <b>KRCMIT-12</b> FOR: MITSUBISHI®	 <b>KRCMIT-12</b> FOR: MITSUBISHI®







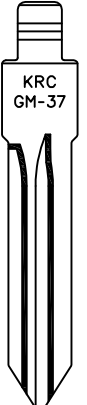

FOR: PEUGEOT®			FOR: PONTIAC®	
				
LAT.	LAT.	LAT.	LAT.	LAT.
.....1-2-3-4-Q-5-6-7-8-H .....A-B-C-D-E-F			H... 1-3988	H... 1-3988
 <b>KRC CIT-1</b> FOR: USHIN®	 <b>KRC HU-HAA</b> FOR: HUF®	 <b>KRC HU-HCA</b> FOR: HUF®	 <b>KRCGM-27</b> FOR: GENERAL MOTORS®	 <b>KRCGM-28</b> FOR: GENERAL MOTORS®

Concerning the marks and commercial denominations see legal warning.  
 Concerniente a las marcas y denominaciones comerciales ver aviso legal.  
 Marka eta izendapen komertzialiei dagokienez, ikus lege-oharra.  
 Concernant les marques et dénominations commerciales voir la note dans l'index.

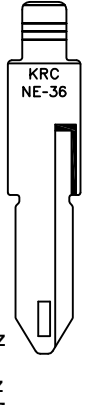
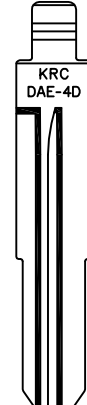







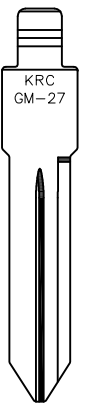
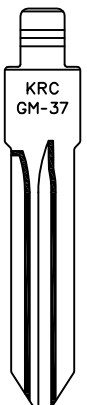

Beziehen auf die marke und handelsname sehen sie die notiz im Impressum.  
 Relativamente às marcas e denominações comerciais, ver aviso legal.  
 Jeśli chodzi o znaki i nazwy handlowe, patrz Informacje prawne.

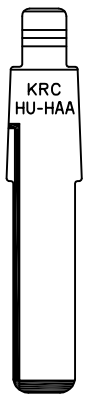









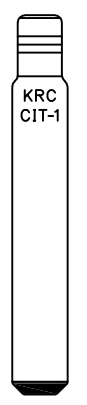

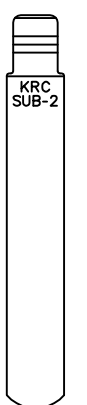







FOR: PONTIAC®		FOR: RENAULT®		FOR: SATURN®
				
LAT.	LAT.	LAT.	LAT.	LAT.
				
FOR: GENERAL MOTORS®	FOR: GENERAL MOTORS®	FOR: USHIN®	FOR: NEIMAN®	FOR: DAEWOO®

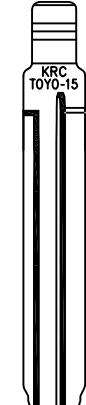
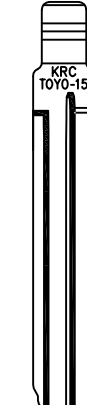

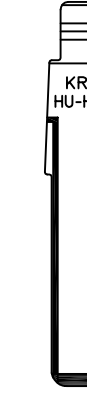

FOR: SATURN®		FOR: SEAT®	FOR: SEAT (AUS)®	FOR: SKODA®
				
LAT.	LAT.	LAT.	LAT.	LAT.
				
FOR: GENERAL MOTORS®	FOR: GENERAL MOTORS®	FOR: HUF®	FOR: HUF®	FOR: HUF®

FOR: SMART®	FOR: SUBARU®	FOR: SUBARU (AUS)®	FOR: SUBARU (USA)®	FOR: SUZUKI®
				
LAT.	LAT.	LAT.	LAT.	LAT.
				
FOR: USHIN®	FOR: SUBARU®	FOR: SUBARU®	FOR: SUBARU®	FOR: SUZUKI®

FOR: TOYOTA®		FOR: TOYOTA (AUS)®	FOR: TOYOTA (USA)®	FOR: VOLKSWAGEN®
				
LAT.	LAT.	LAT.	LAT.	LAT.
				
FOR: HUF®	FOR: TOYOTA®	FOR: TOYOTA®	FOR: TOYOTA®	FOR: HUF®

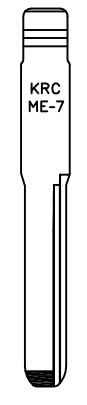
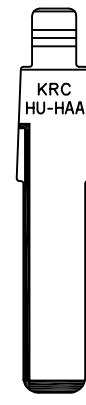
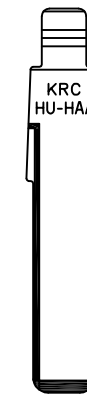
FOR: VOLKSWAGEN®	FOR:VOLKSWAGEN(AUS)®	FOR:VOLKSWAGEN(USA)®
		
LAT.	LAT.	LAT.
		
FOR: VOLKSWAGEN®	FOR: HUF®	FOR: HUF®

Concerning the marks and commercial denominations see legal warning.  
 Concerniente a las marcas y denominaciones comerciales ver aviso legal.  
 Marka eta izendapen komertzialak dagokienez, ikus lege-oharra.  
 Concernant les marques et dénominations commerciales voir la note dans l'index.



## SNAP LOCK KEYS

Llaves de cierre  
Iste Giltzak

Clés de fermeture  
Absperröhne

Chaves de fecho  
Klucze Nasadowe



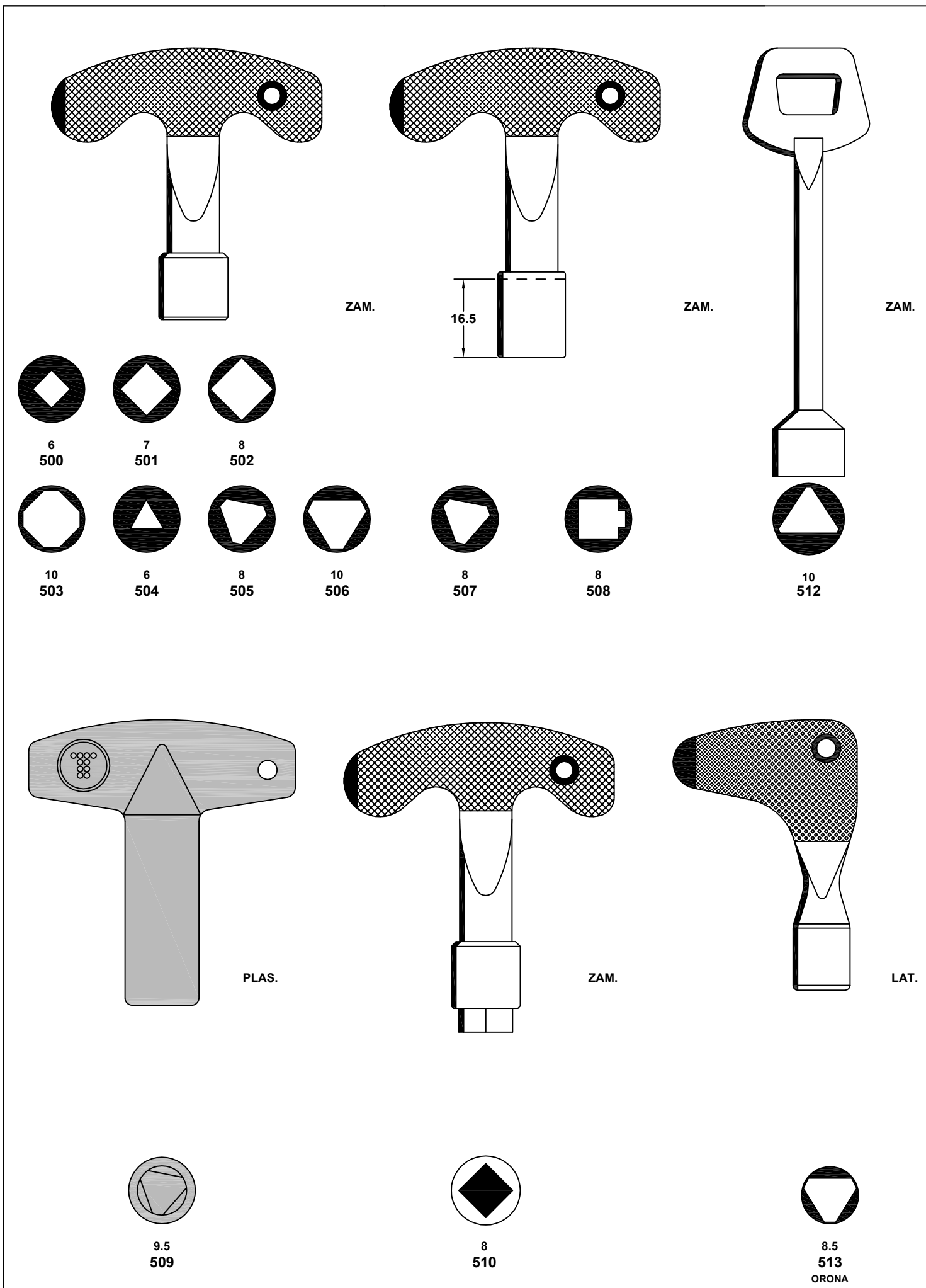

## CROSS - SHAPED KEYS

Llaves de cruz  
Gurutze motako giltzak

Clés cruciformes  
Kreuzbartschlüssel

Chaves de cruz  
Klucze krzyżowe

Concerning the marks and commercial denominations see legal warning.  
Concerniente a las marcas y denominaciones comerciales ver aviso legal.  
Marka eta izendapen komertzialak dagokienez, ikus lege-oharra.  
Concernant les marques et dénominations commerciales voir la note dans l'index.



FOR: AGC®		FOR: ALA®		FOR: BLUMA®	
		7	6	7	
		12	14.3	17.6	
AGD-1X CCF3	AGD-2X CCF3	ALA-1X	BLU-1X	BLU-2X	

FOR: BURG®		FOR: CCF®		
7	6			
15	15			
BUR-4X 70mm	BUR-5X 70mm	CCF-1X	CCF-5X	CCF-8X

FOR: BRICARD®		FOR: BURG®		
		6.7	7	6.7
		11.8	11.8	11.8
BRI-1X	BRI-2X	BUR-1X 75mm FOR: TRIOVING®	BUR-2X 90mm FOR: TESA®	BUR-3X 100mm FOR: TESA®

FOR: CCF®		FOR: CIFIAL®	FOR: CRC CAMBOA®	FOR: DEBEAURAIN®
CCF-9X	CCF-10X	CIF-1X CCF4	CRC-1X	DEB-1X

Concerning the marks and commercial denominations see legal warning.  
 Concerniente a las marcas y denominaciones comerciales ver aviso legal.  
 Marka eta izendapen komertzialiei dagokienez, ikus lege-oharra.  
 Concernant les marques et dénominations commerciales voir la note dans l'index.

**JMA®** Opening the future

**JMA®** Opening the future

Beziehen auf die marke und handelsname sehen sie die notiz im index.  
 Relativamente às marcas e denominações comerciais, ver aviso legal.  
 Jeśli chodzi o znaki i nazwy handlowe, patrz Informacje prawne.

FOR: DOOR LOCK®  8 18.1 DOL-1X	FOR: FAYN®  7 11.4 FAY-1X	FOR: FIAM®  7 11.8 FM-1X	FOR: FIAM®  7 11.8 FM-2X	FOR: FRIPA®  7 16.5 FRI-1X FOR: GERA®
--	---------------------------------------	--------------------------------------	--------------------------------------	--

FOR: FRIPA®  7 16.5 FRI-2X FOR: GERA®	FOR: GERA®  7 16.5 GEA-1X		FOR: GERA®  7 16.5 GEA-3X	
FOR: HELCO KVV®  7 17.8 KFV-1X 75mm		FOR: HELCO KVV®  7 17.8 KFV-2X 85mm		

FOR: HELCO KVV®  7 17.8 KVV-3X 100mm	FOR: ISEO®  7 12.8 IS-1X	FOR: KRESTI®  7.8 18.70 KR-1X			FOR: KRESTI®  7.9 9.7 21 KR-2X	FOR: KRESTI®  7.9 9.7 21 KR-3X
---	--------------------------------------	---	--	--	---	---

FOR: KRESTI®  7.8 10 16 0.8 1.8 KR-4X		FOR: KRESTI®  7 24 1.30 KR-5X	FOR: KRESTI®  6.9 10.3 0.9 1.9 KR-6X	FOR: KRESTI®  7.8 12.7 1 1.3 KR-7X	FOR: KRESTI®  5.9 9.7 32.5 1.7 KR-8X
--	--	--	--	--	--

Concerning the marks and commercial denominations see legal warning.  
 Concerniente a las marcas y denominaciones comerciales ver aviso legal.  
 Marka eta izendapen komertzialiei dagokienez, ikus lege-oharra.  
 Concernant les marques et dénominations commerciales voir la note dans l'index.

**JMA** Opening the future

**JMA** Opening the future

Beziehen auf die marke und handelsname sehen sie die notiz im index.  
 Relativamente às marcas e denominações comerciais, ver aviso legal.  
 Jeśli chodzi o znaki i nazwy handlowe, patrz Informacje prawne.

FOR: KRESTI®

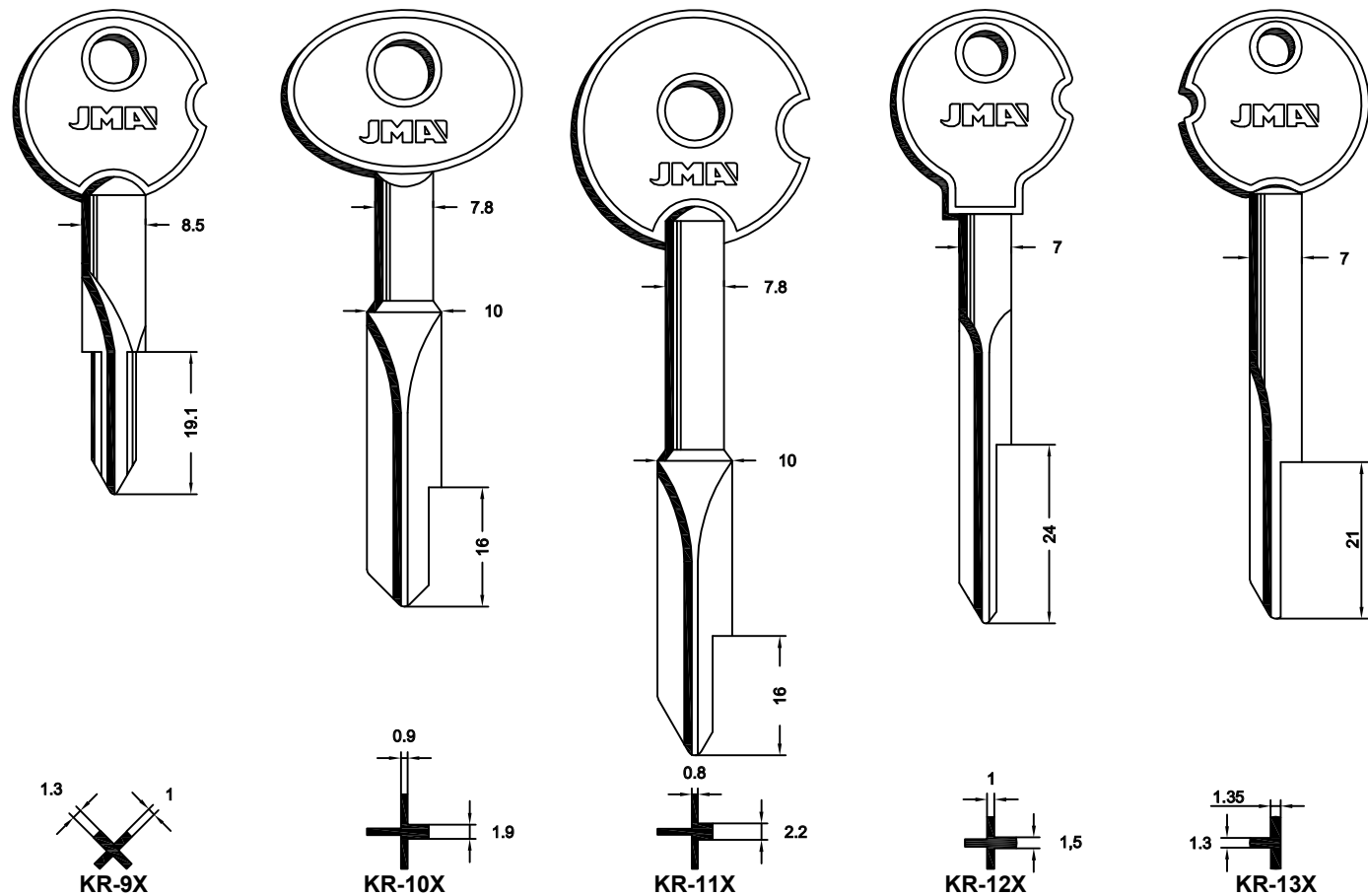

FOR: MAFOR®

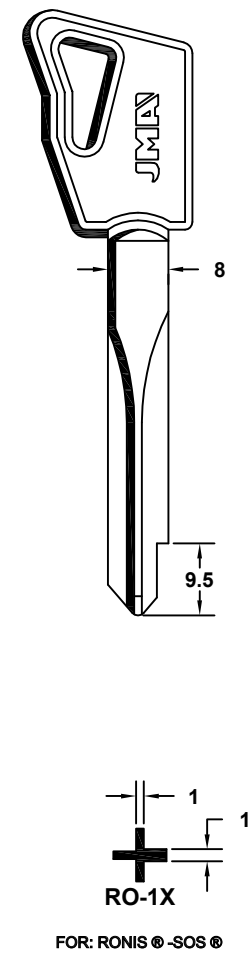

FOR: MINI MOLA®

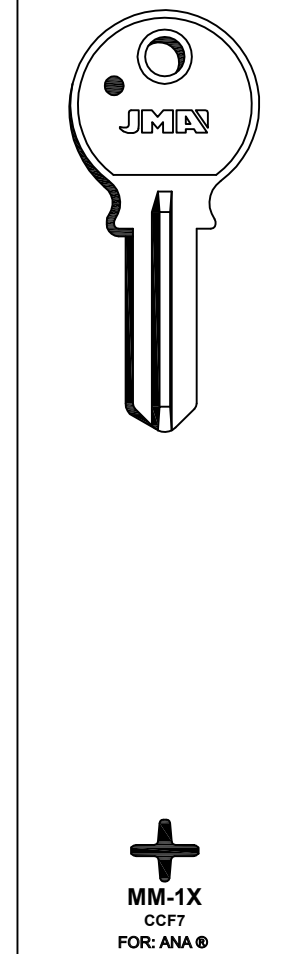

FOR: MOREAUX®

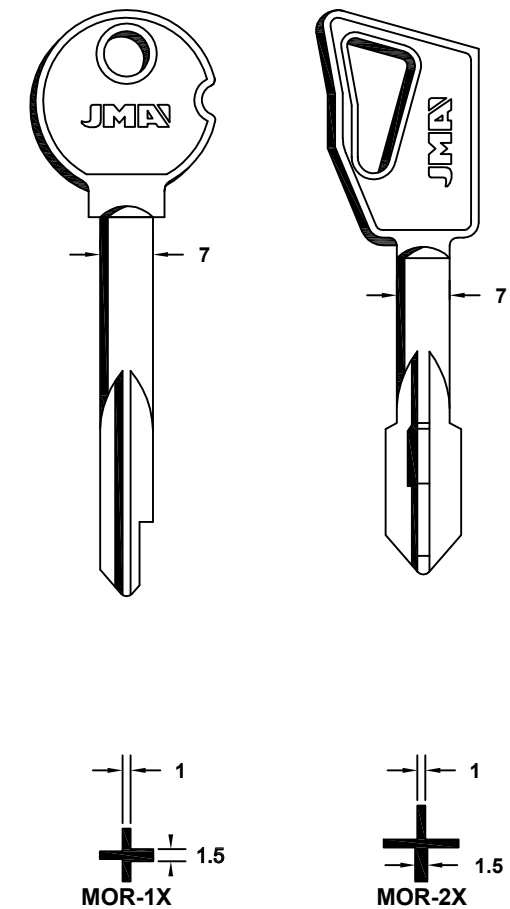

FOR: MSV®

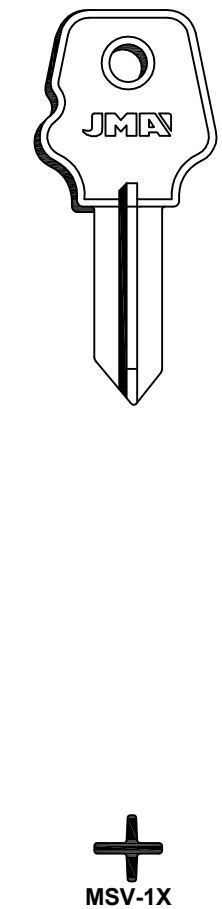

FOR: KRESTI®

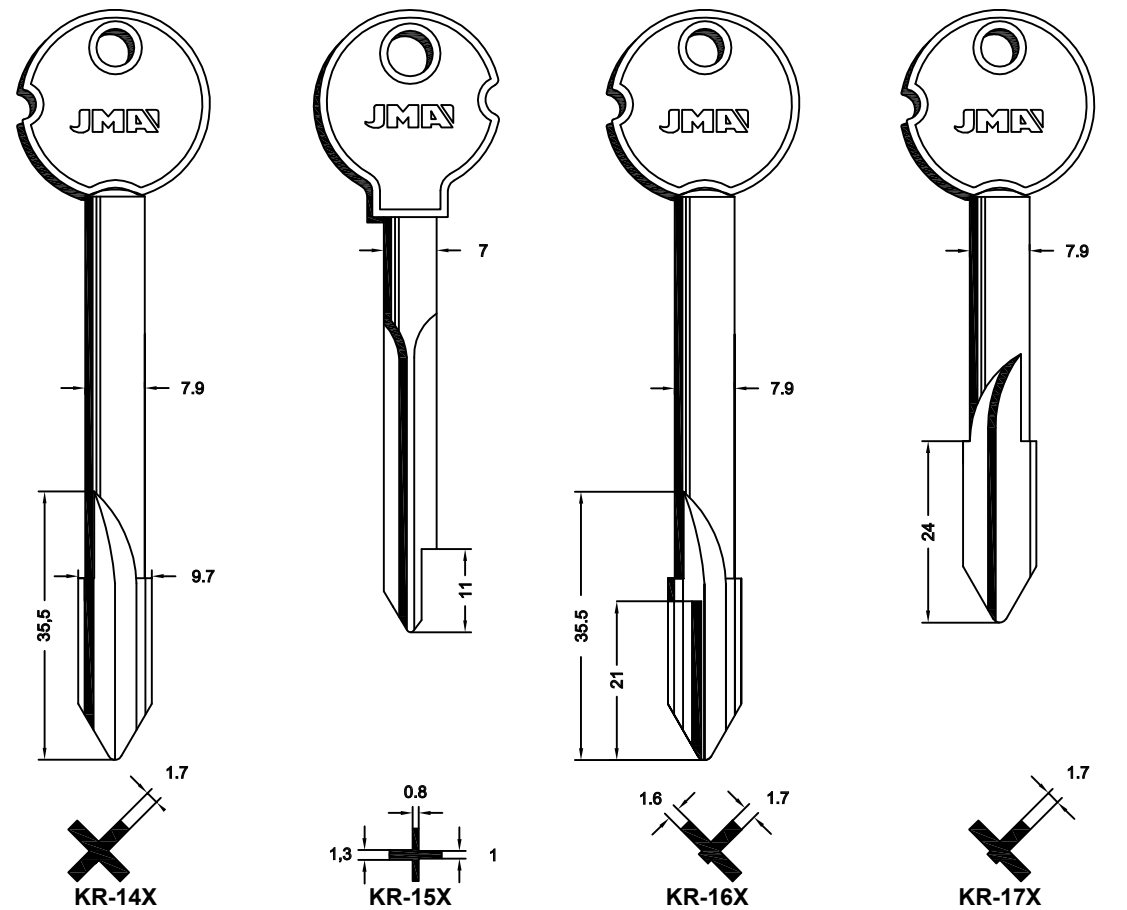

FOR: LOCK-IT®

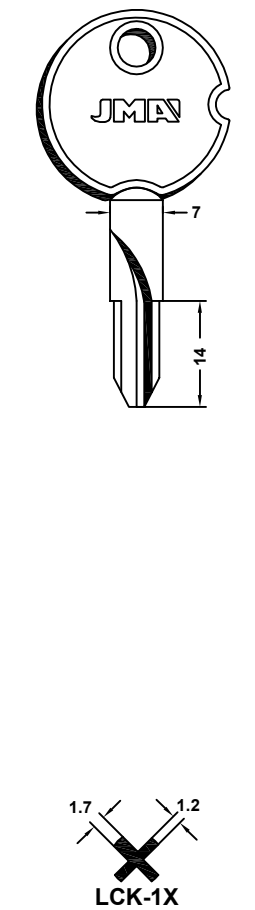

FOR: NABOB®

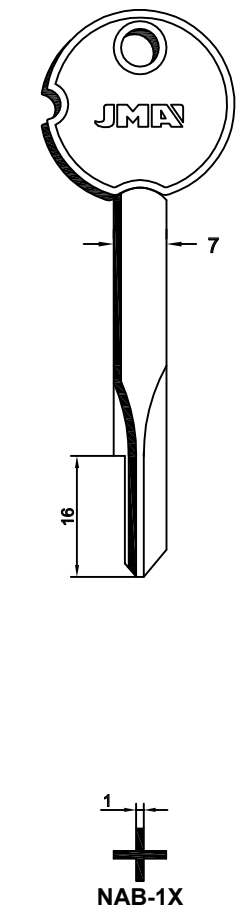

FOR: NEMEF®

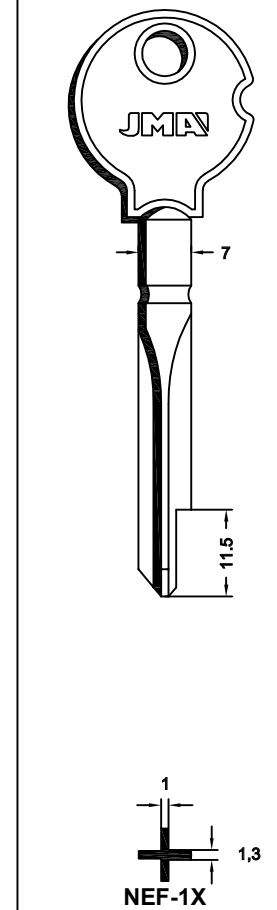

FOR: PAPAIZ®

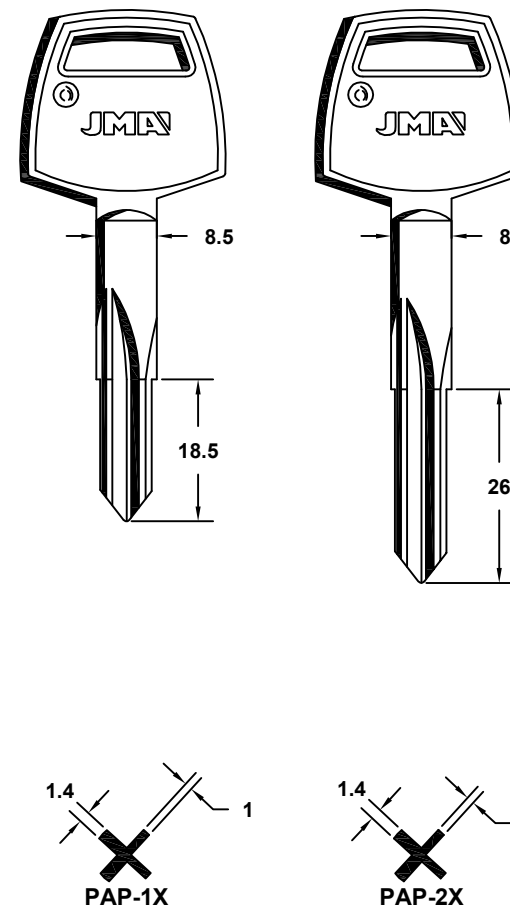

FOR: TUFF®

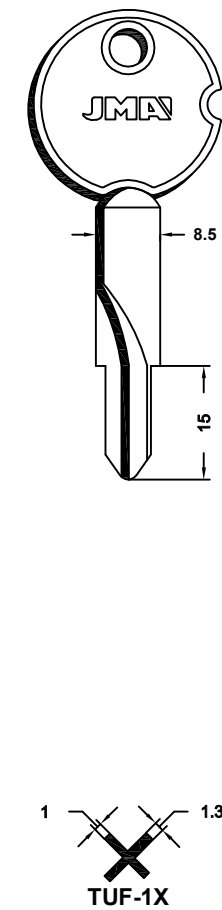

Concerning the marks and commercial denominations see legal warning.  
 Concerniente a las marcas y denominaciones comerciales ver aviso legal.  
 Marka eta izendapen komertzialiei dagokienez, ikus lege-oharra.  
 Concernant les marques et dénominations commerciales voir la note dans l'index.

**JMA**® Opening the future

**JMA**® Opening the future

Beziehen auf die marke und handelsname sehen sie die notiz im index.  
 Relativamente às marcas e denominações comerciais, ver aviso legal.  
 Jeśli chodzi o znaki i nazwy handlowe, patrz Informacje prawne.

K06 / 377



FOR: TUFF®		UNIVERSAL	FOR: YALE BKS®	
TUF-2X	TUF-3X	U-1X	YA-1X 78mm	YA-2X 85mm

FOR: ZEISS IKON®				
ZE-3X 85mm	ZE-4X	ZE-5X 100mm	ZE-6X	ZE-7X 75mm
				ZE-8X 90mm
				ZE-9X 105mm

FOR: YALE BKS®	FOR: YALE®			FOR: ZEISS IKON®
YA-3X 100mm	YA-4X 80mm	YA-5X 95mm	YA-6X 108mm	ZE-1X 70mm
	FOR: CR® -FIAM® -PRAZIS®			ZE-2X

Concerning the marks and commercial denominations see legal warning.  
 Concerniente a las marcas y denominaciones comerciales ver aviso legal.  
 Marka eta izendapen komertzialiei dagokienez, ikus lege-oharra.  
 Concernant les marques et dénominations commerciales voir la note dans l'index.

**JMA** Opening the future

**JMA** Opening the future

Beziehen auf die marke und handelsname sehen sie die notiz im index.  
 Relativamente às marcas e denominações comerciais, ver aviso legal.  
 Jeśli chodzi o znaki i nazwy handlowe, patrz Informacje prawne.





## MORTICE KEYS

Llaves de Gorja  
Gorja motako giltzak

Clés à gorge  
Tresor-Schlüssel

Chaves de gorja  
Klucze zasuwowe



# STEEL

Acero  
Altzairua

Acier  
Stahl

Aço  
Stal

## MORTICE KEYS

Llaves de Gorja  
Gorja motako giltzak

Clés à gorge  
Tresor-Schlüssel

Chaves de gorja  
Klucze zasuwowe



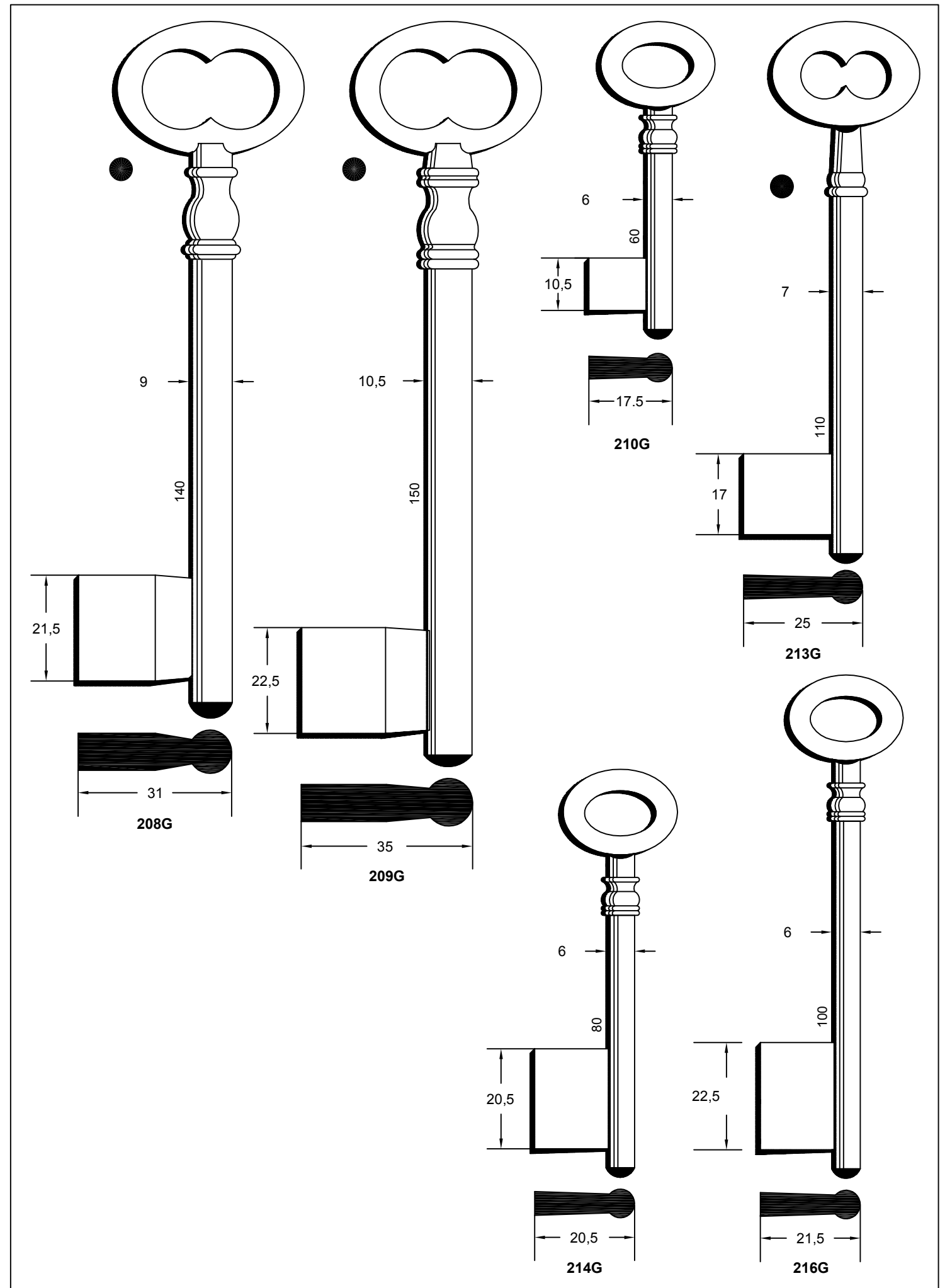
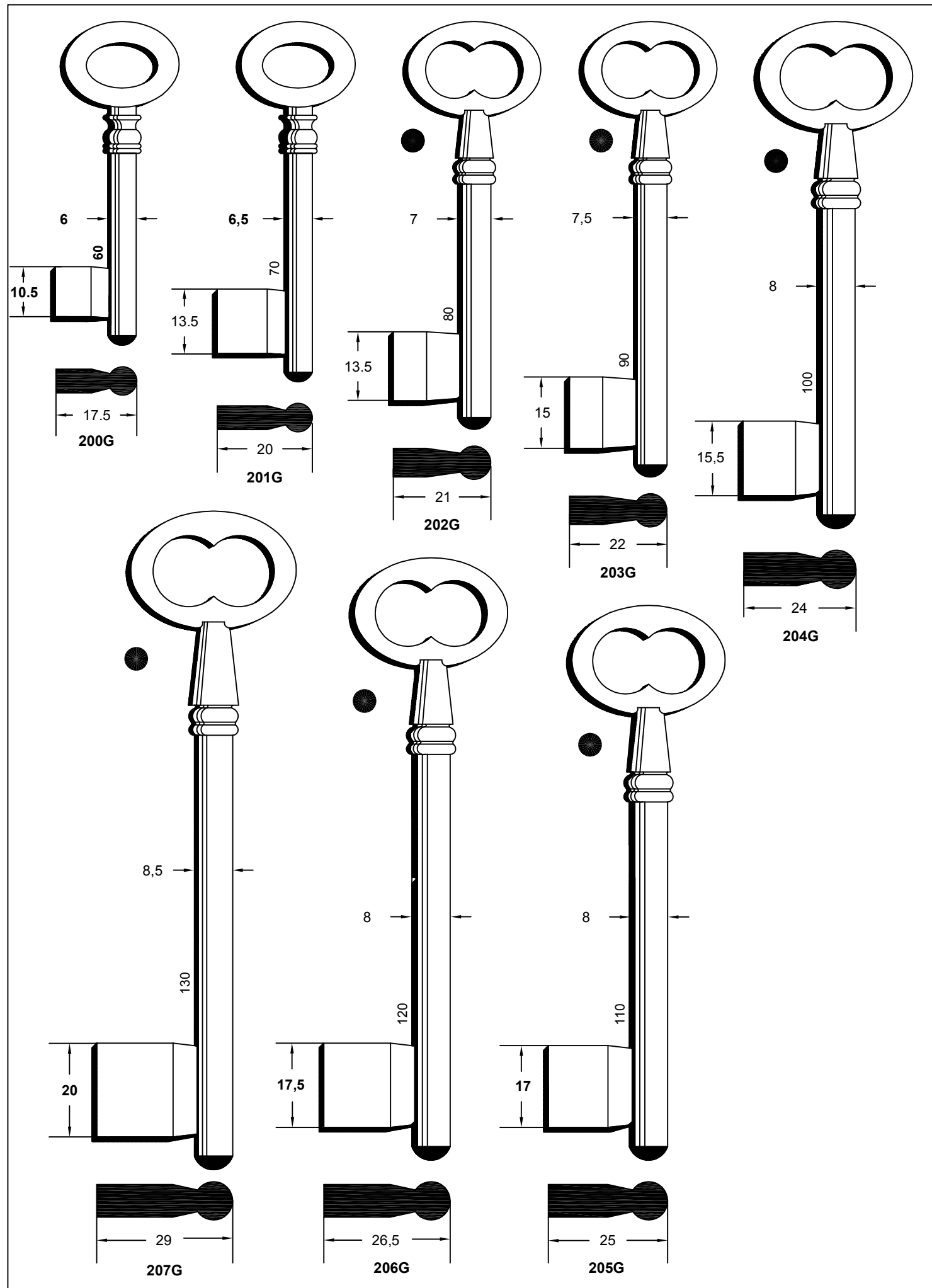

Concerning the marks and commercial denominations see legal warning.  
 Concerniente a las marcas y denominaciones comerciales ver aviso legal.  
 Marka eta izendapen komertzialei dagokienez, ikus lege-oharra.  
 Concernant les marques et dénominations commerciales voir la note dans l'index.

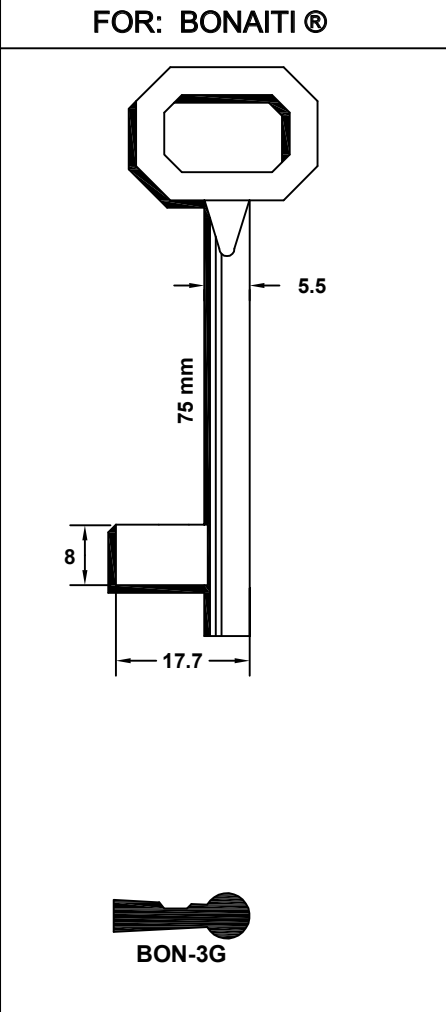
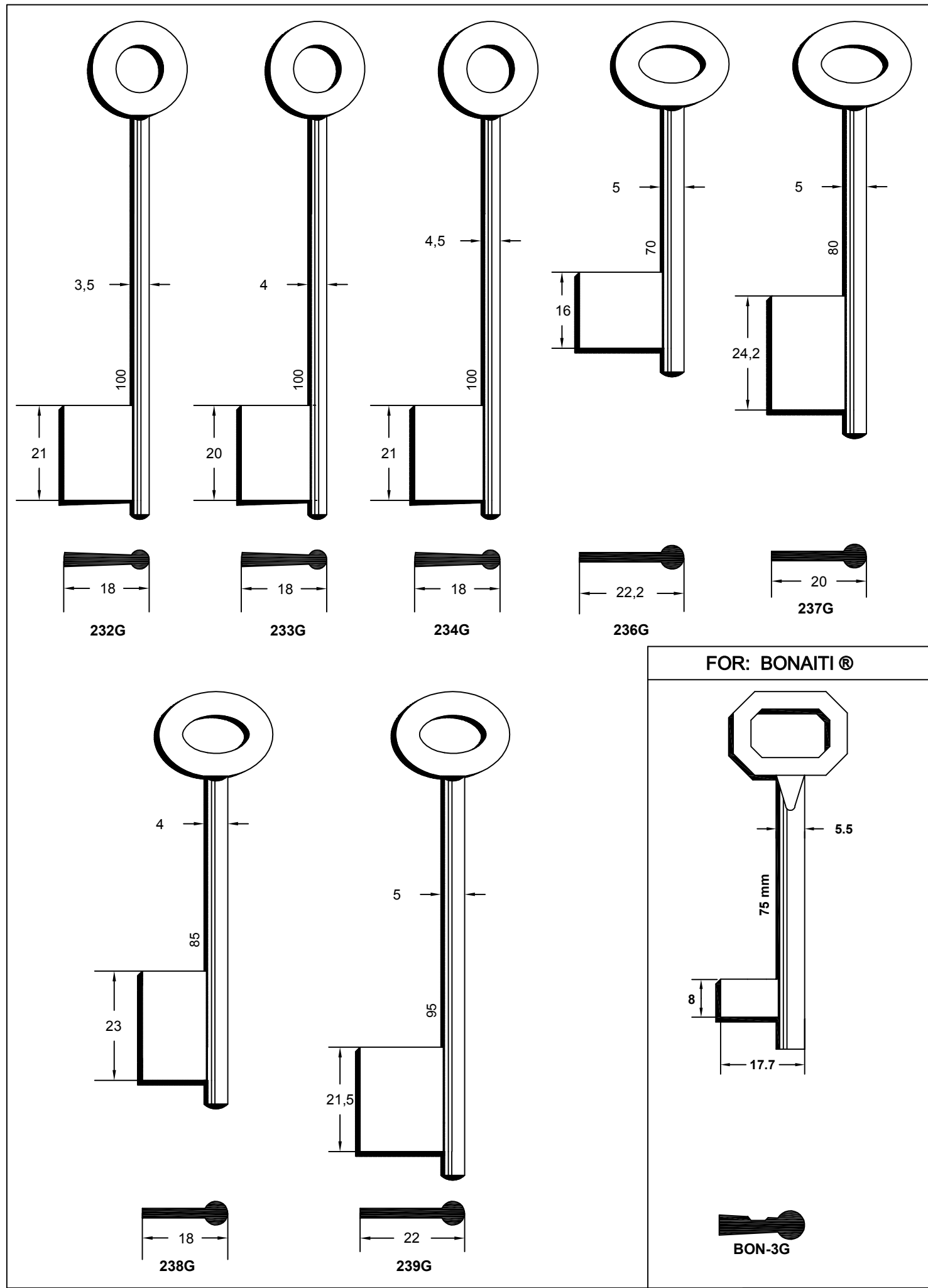
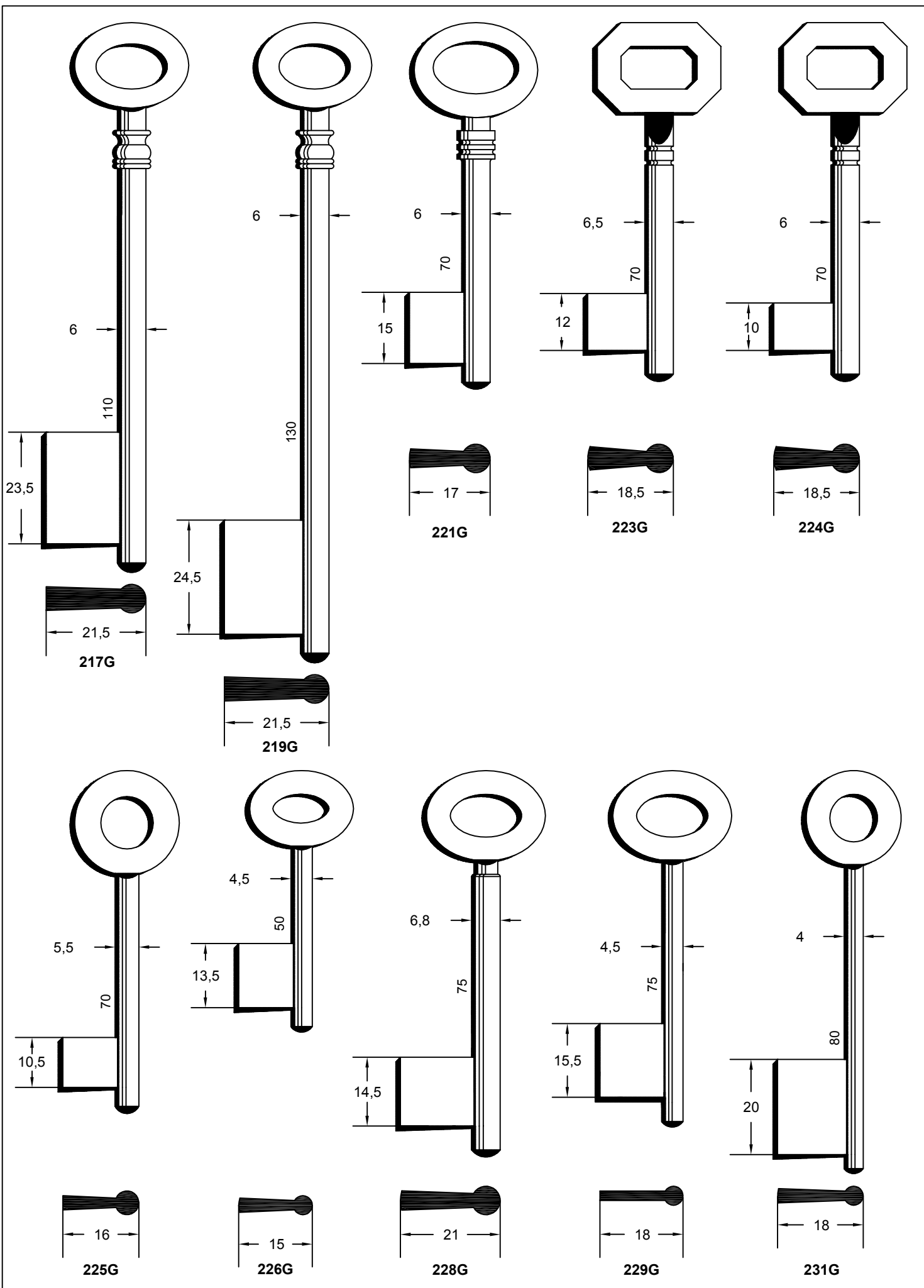

Concerning the marks and commercial denominations see legal warning.  
 Concerniente a las marcas y denominaciones comerciales ver aviso legal.  
 Marka eta izendapen komertzialiei dagokienez, ikus lege-oharra.  
 Concernant les marques et dénominations commerciales voir la note dans l'index.



Beziehen auf die marke und handelsname sehen sie die notiz im index.  
 Relativamente às marcas e denominações comerciais, ver aviso legal.  
 Jeśli chodzi o znaki i nazwy handlowe, patrz Informacje prawne.



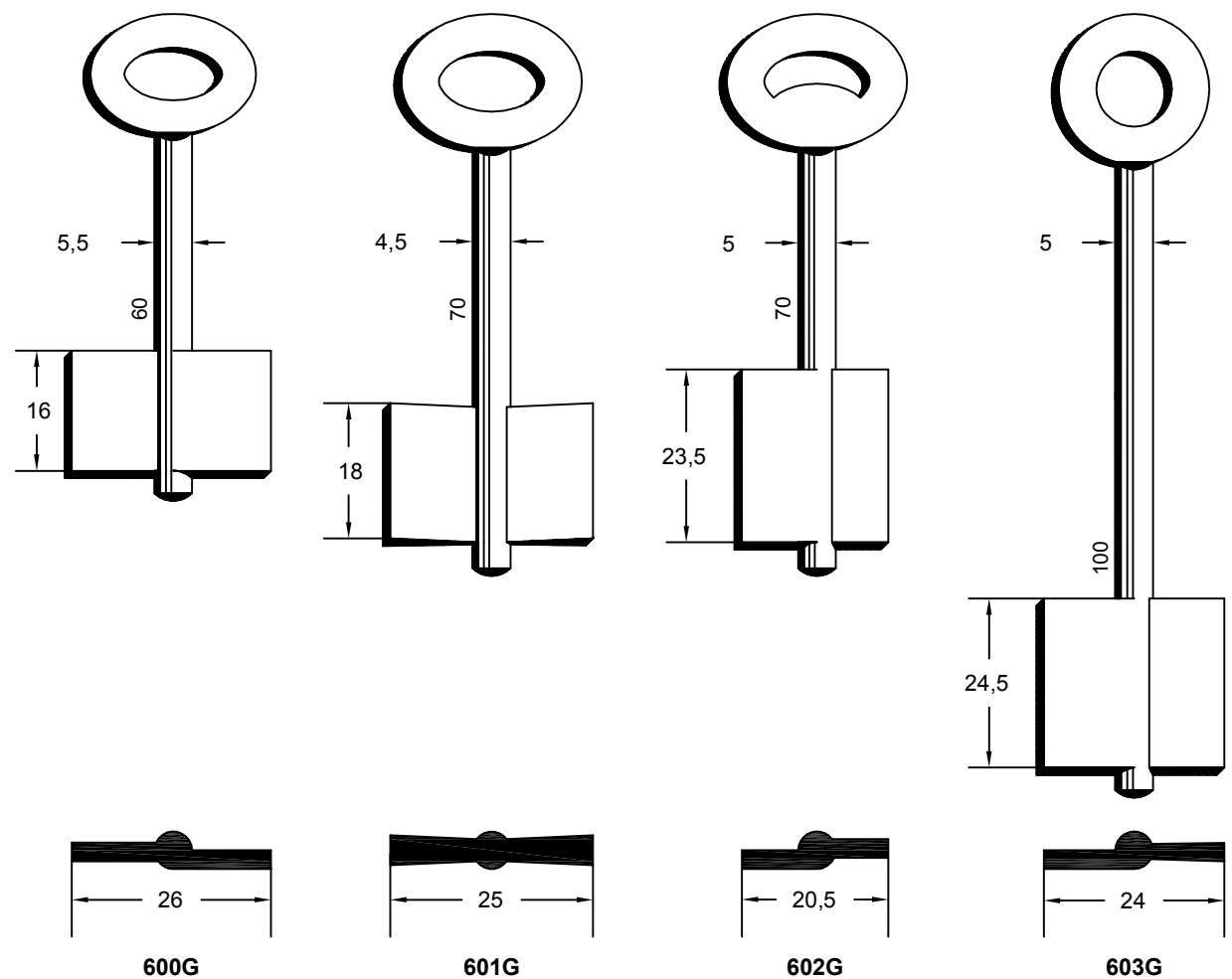

600G

601G

602G

603G

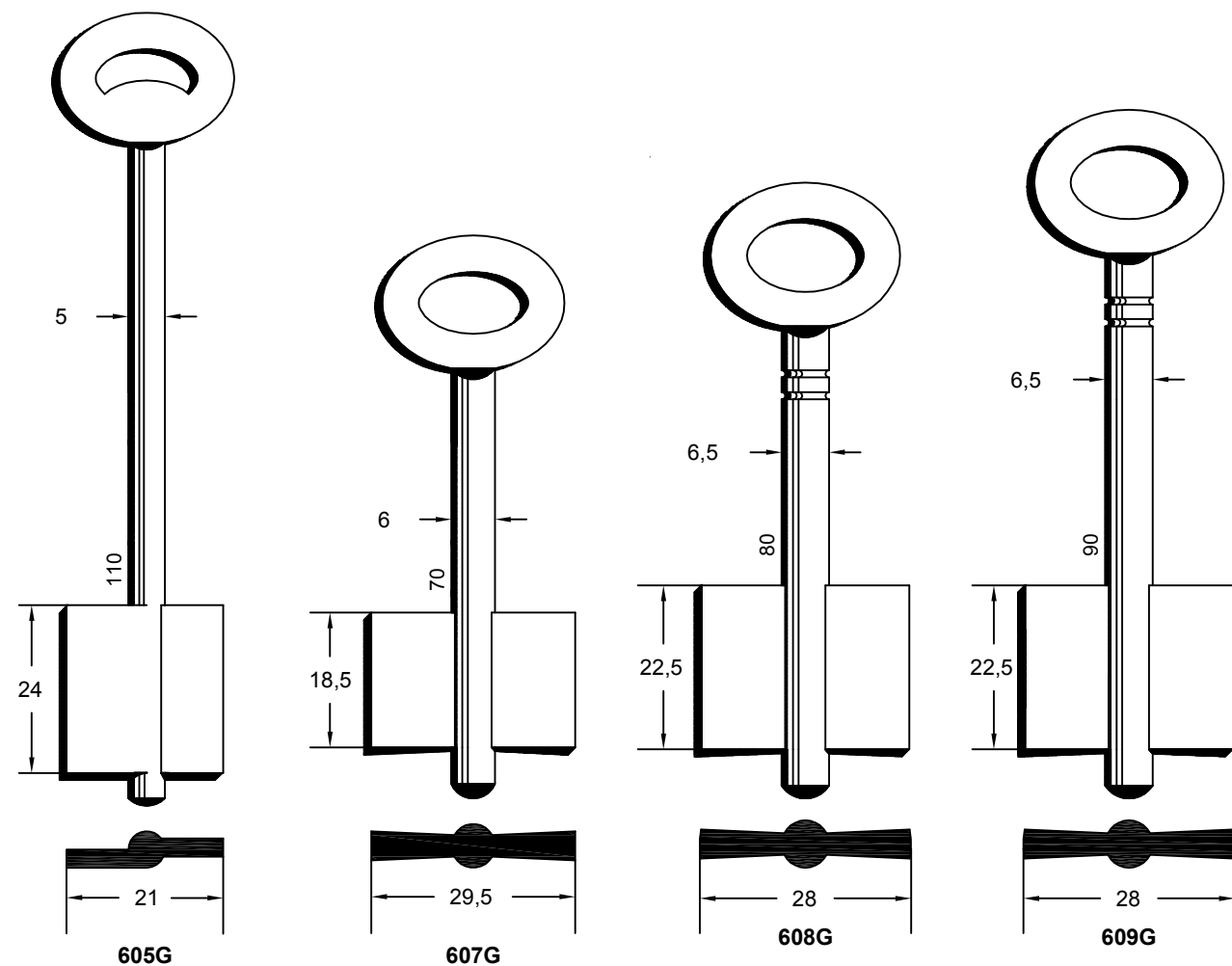

605G

607G

608G

609G

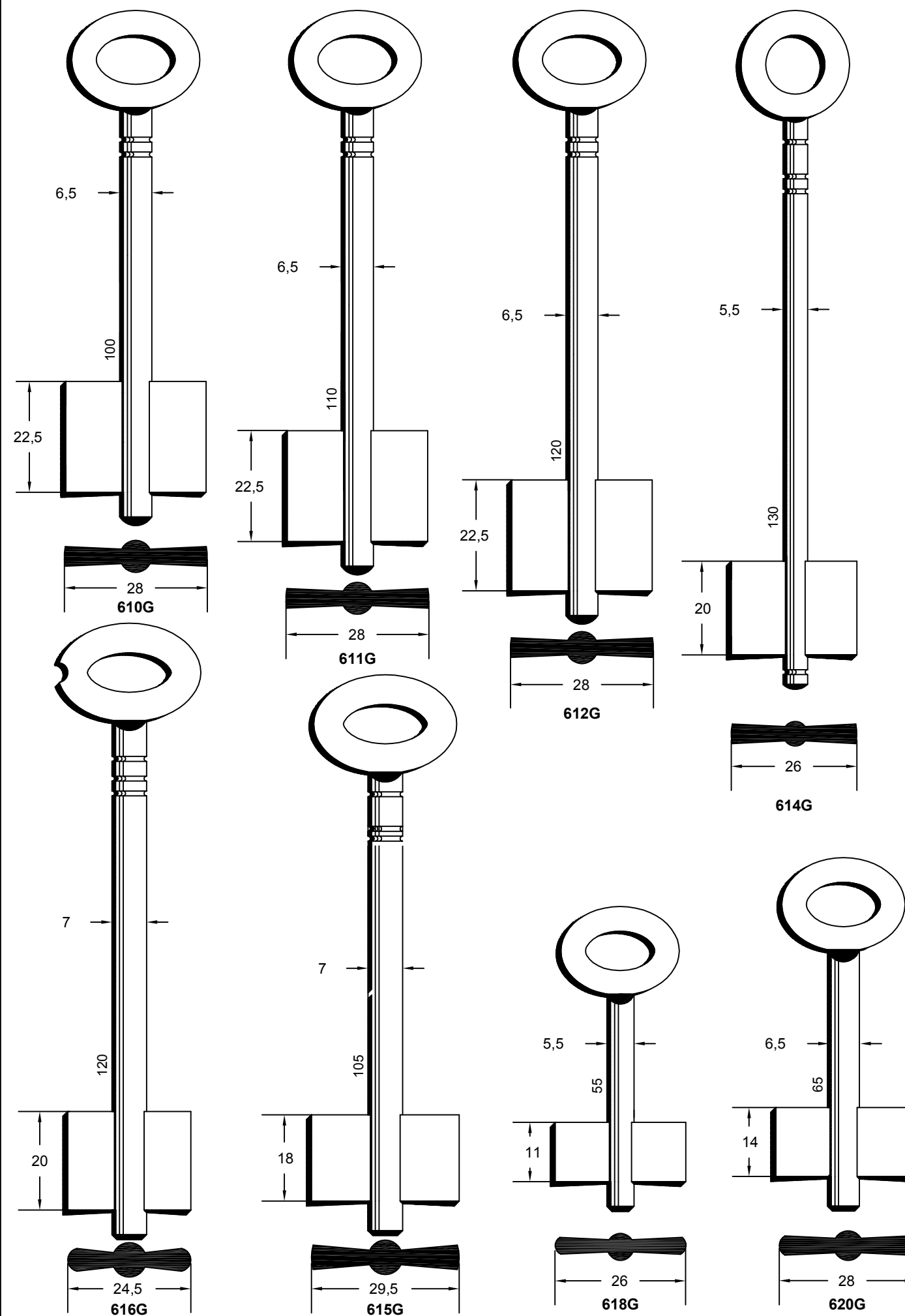

610G

611G

612G

614G

616G

615G

618G

620G

Concerning the marks and commercial denominations see legal warning.  
 Concerniente a las marcas y denominaciones comerciales ver aviso legal.  
 Marka eta izendapen komertzialei dagokienez, ikus lege-oharra.  
 Concernant les marques et dénominations commerciales voir la note dans l'index.



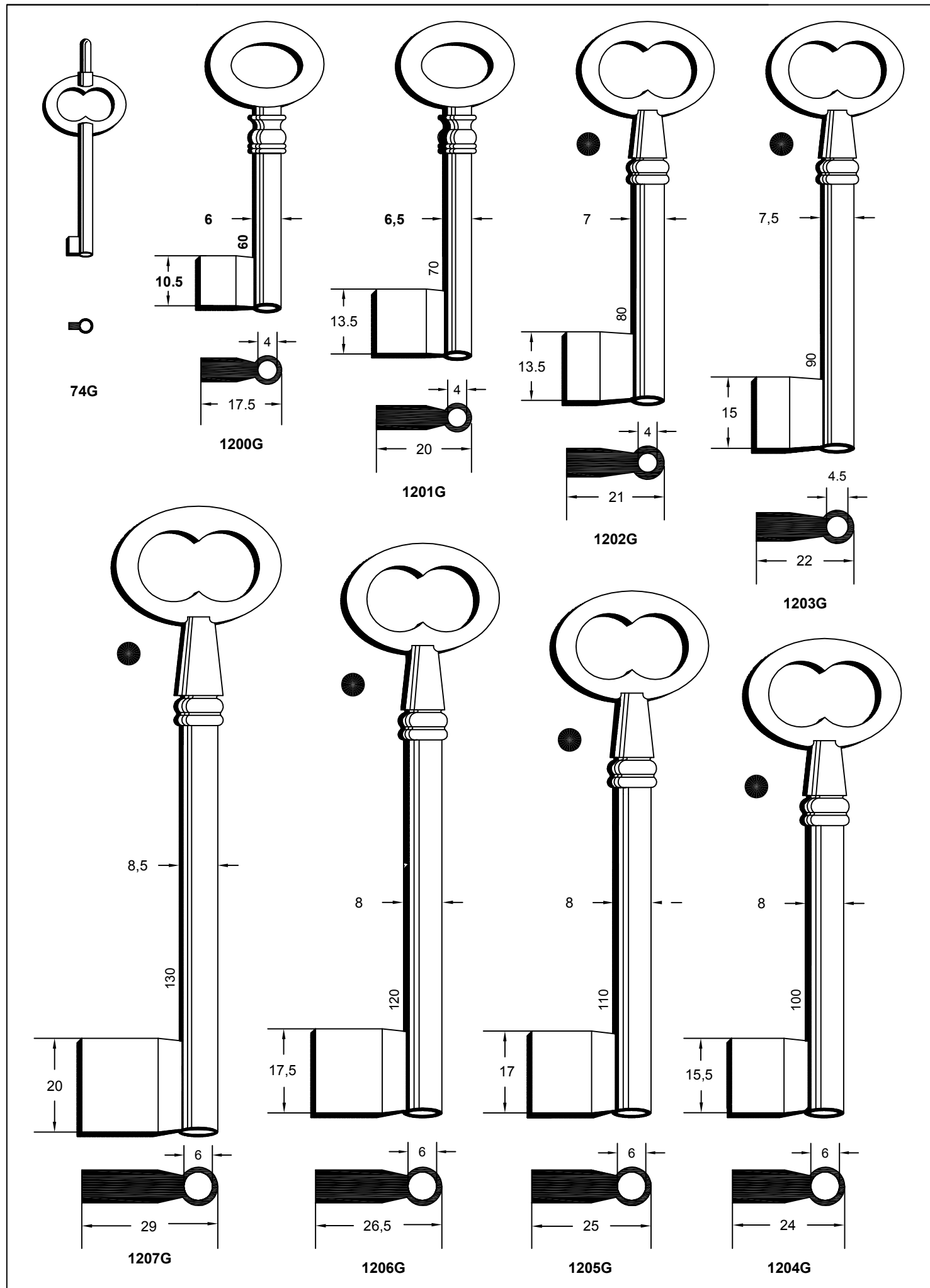
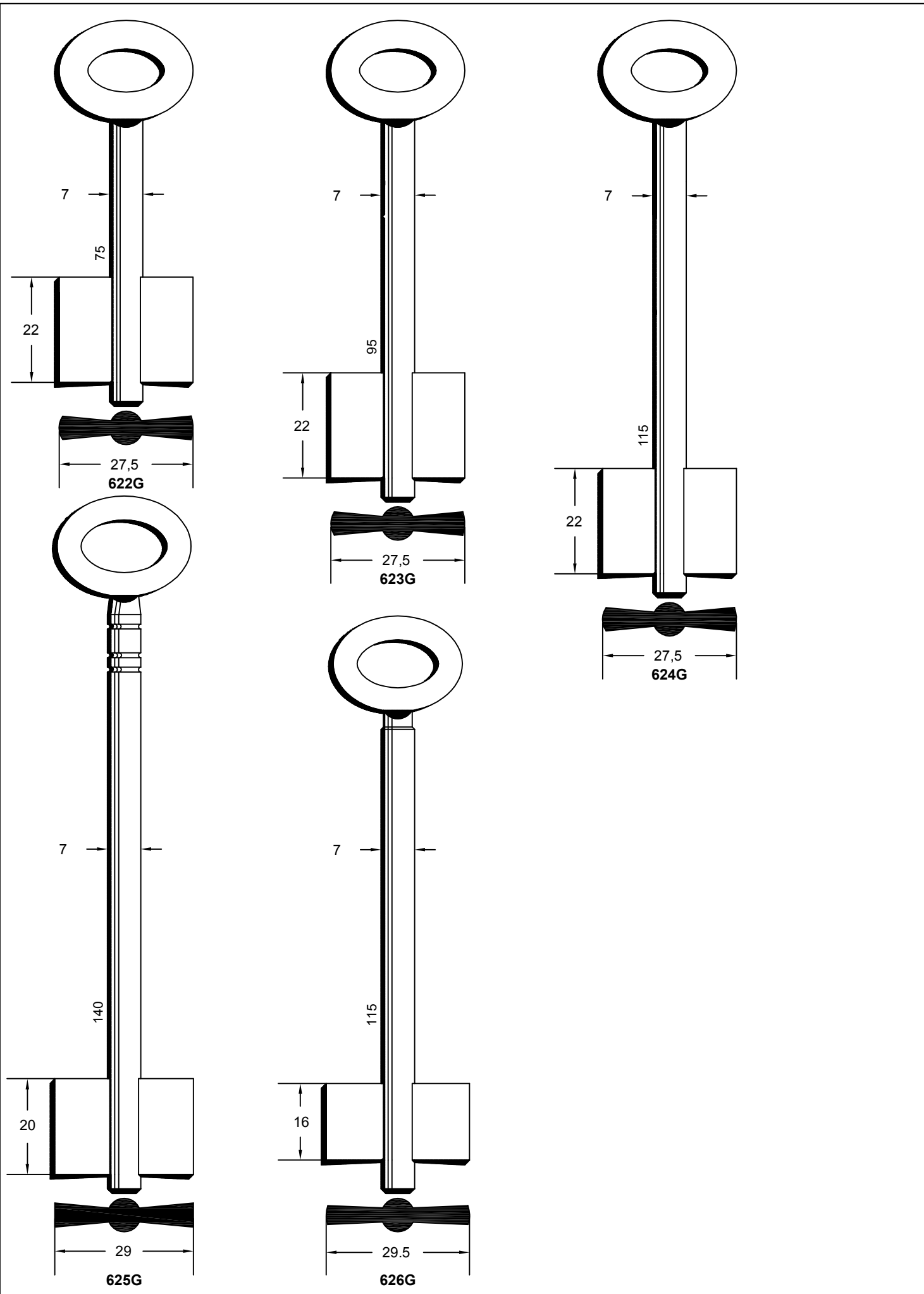

Concerning the marks and commercial denominations see legal warning.  
 Concerniente a las marcas y denominaciones comerciales ver aviso legal.  
 Marka eta izendapen komertzialiei dagokienez, ikus lege-oharra.  
 Concernant les marques et dénominations commerciales voir la note dans l'index.

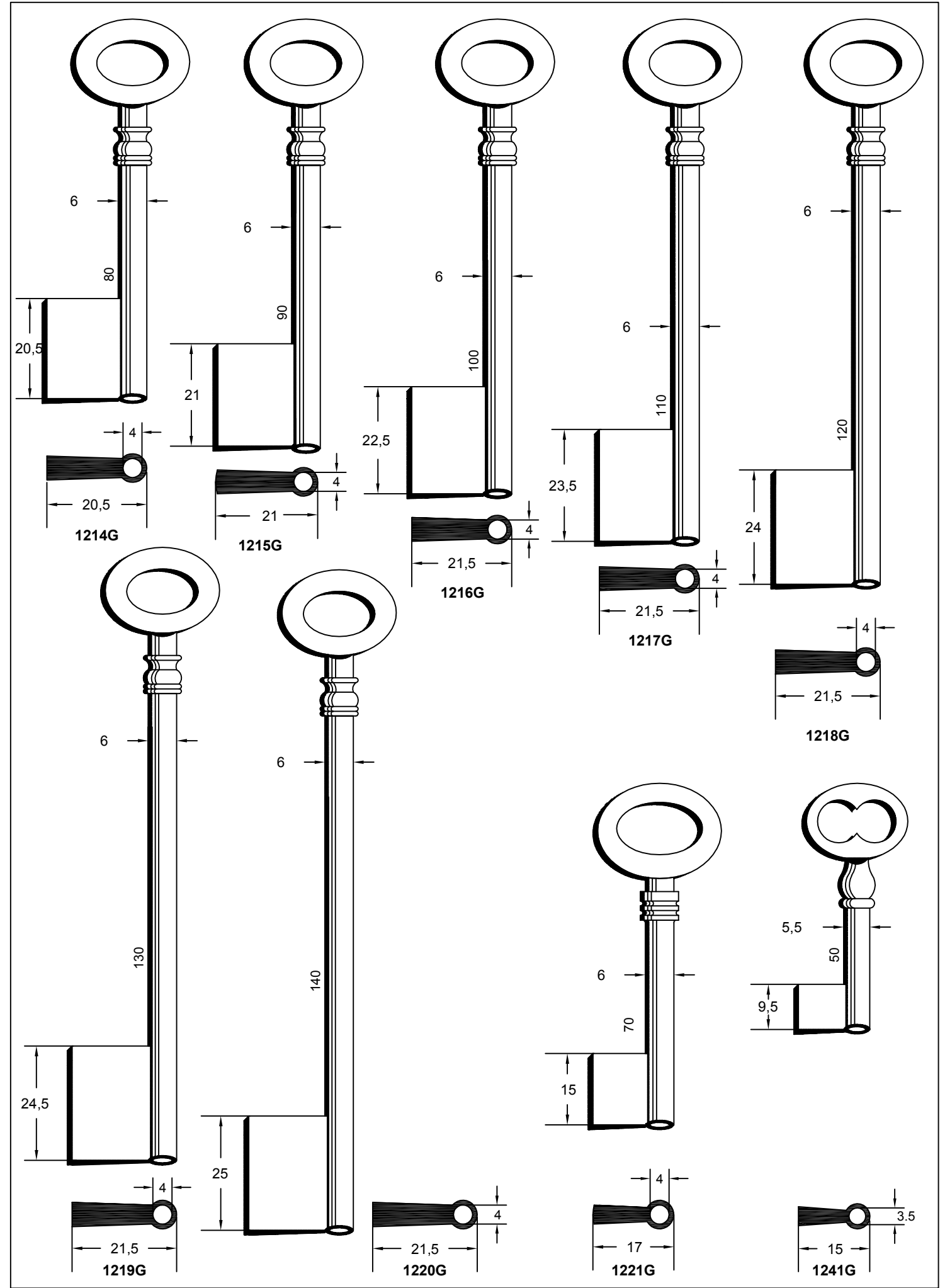
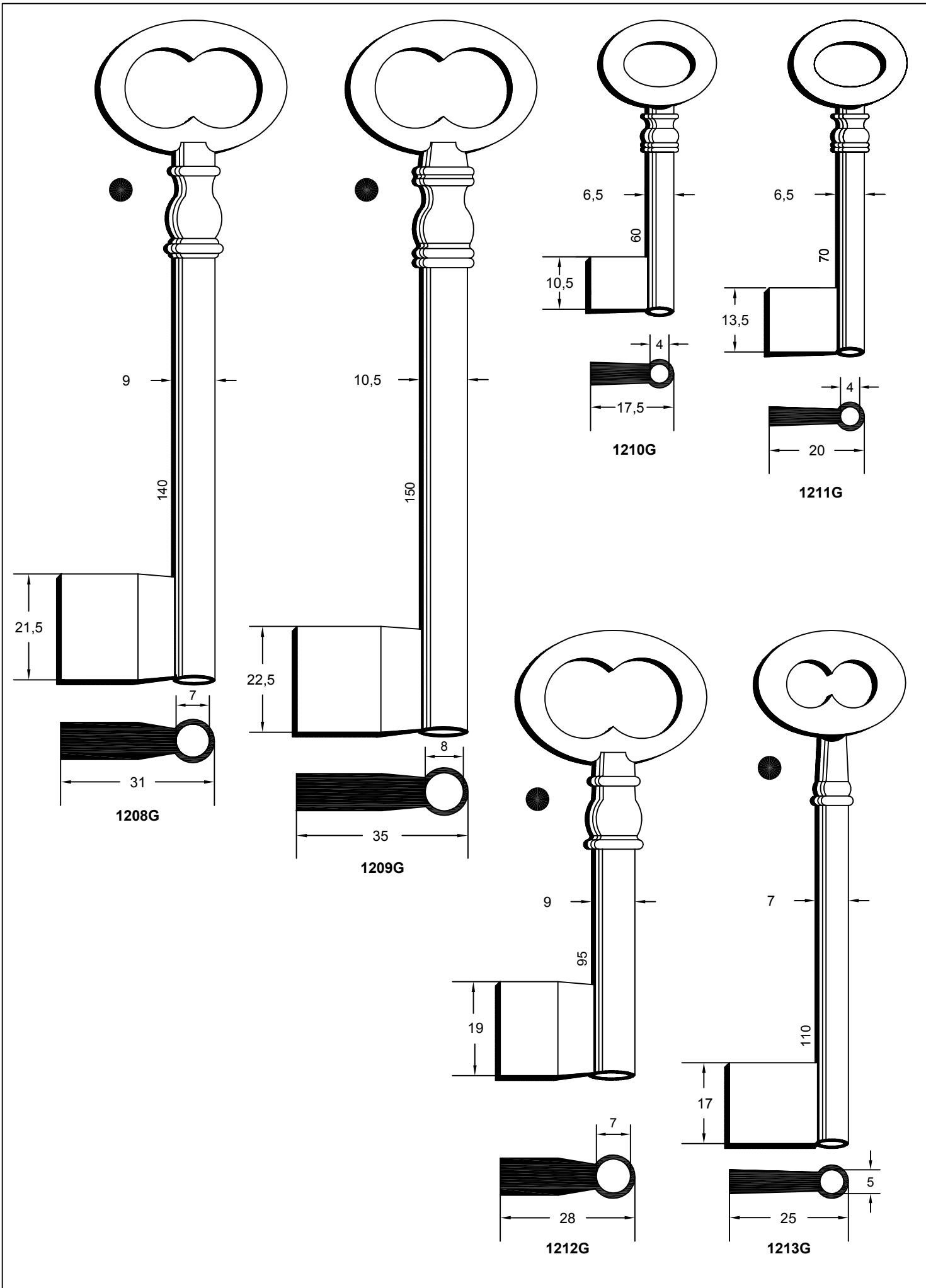

Concerning the marks and commercial denominations see legal warning.  
 Concerniente a las marcas y denominaciones comerciales ver aviso legal.  
 Marka eta izendapen komertzialiei dagokienez, ikus lege-oharra.  
 Concernant les marques et dénominations commerciales voir la note dans l'index.

**JMA** Opening the future

**JMA** Opening the future

Beziehen auf die marke und handelsname sehen sie die notiz im index.  
 Relativamente às marcas e denominações comerciais, ver aviso legal.  
 Jeśli chodzi o znaki i nazwy handlowe, patrz Informacje prawne.

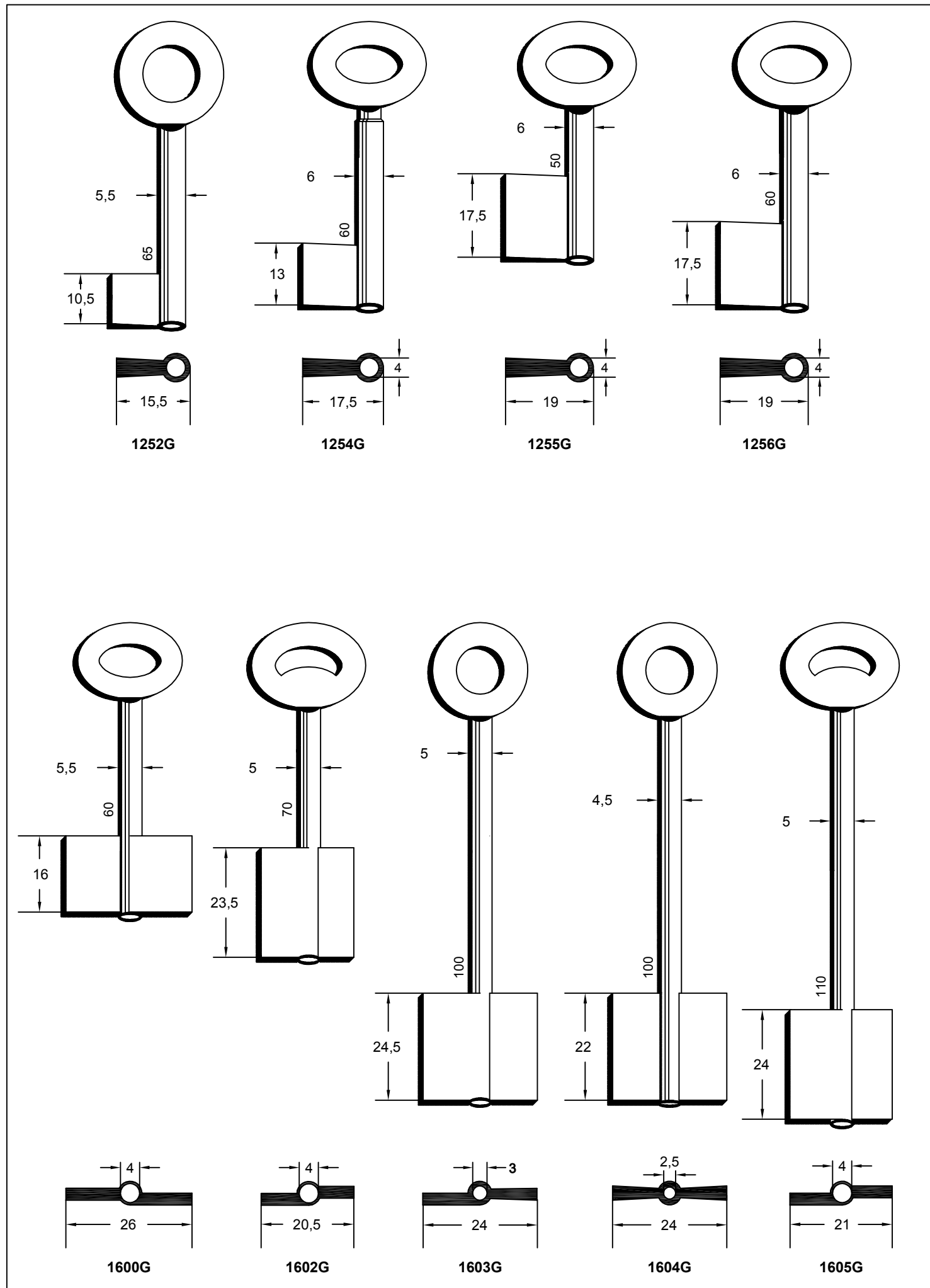
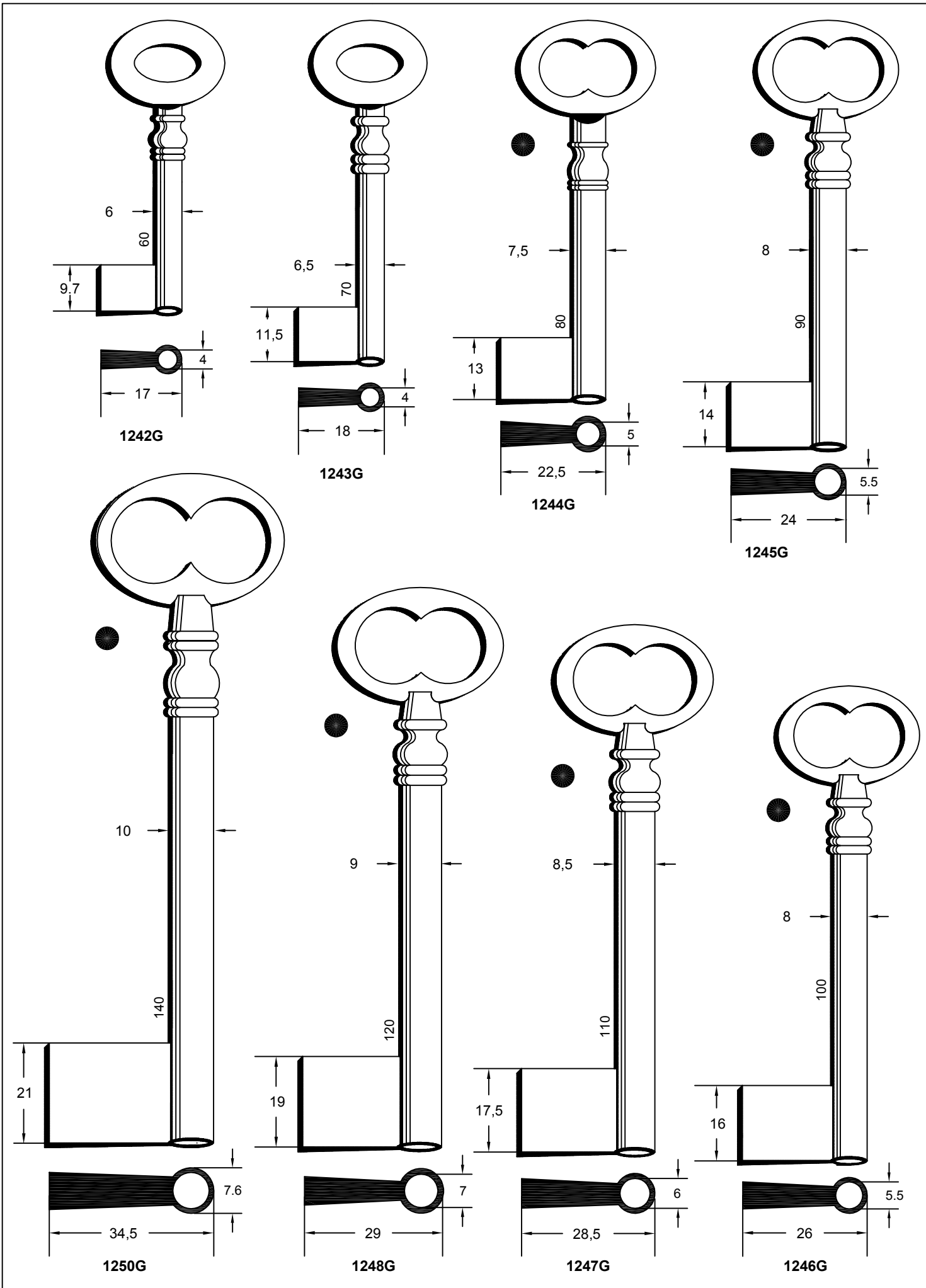

Concerning the marks and commercial denominations see legal warning.  
 Concerniente a las marcas y denominaciones comerciales ver aviso legal.  
 Marka eta izendapen komertzialiei dagokienez, ikus lege-oharra.  
 Concernant les marques et dénominations commerciales voir la note dans l'index.



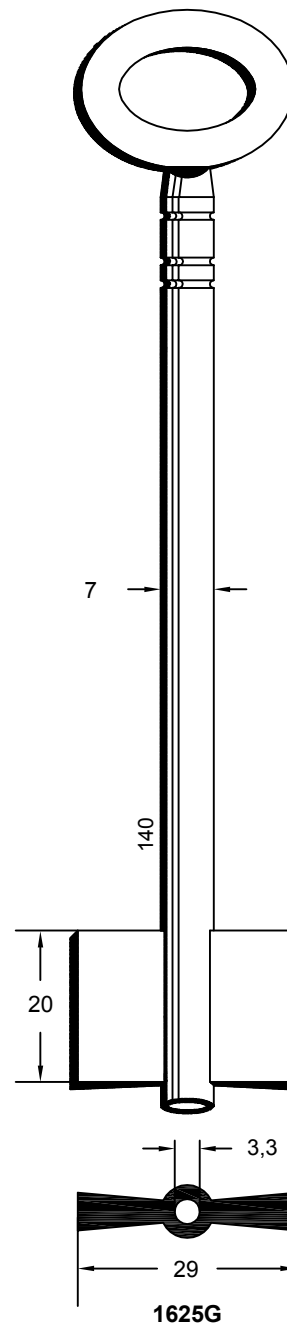
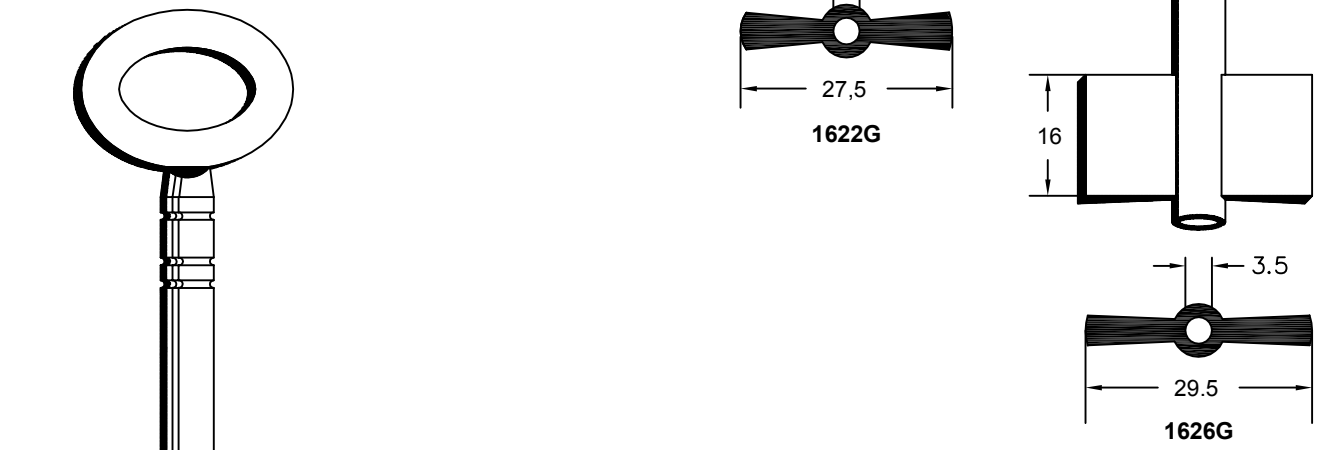
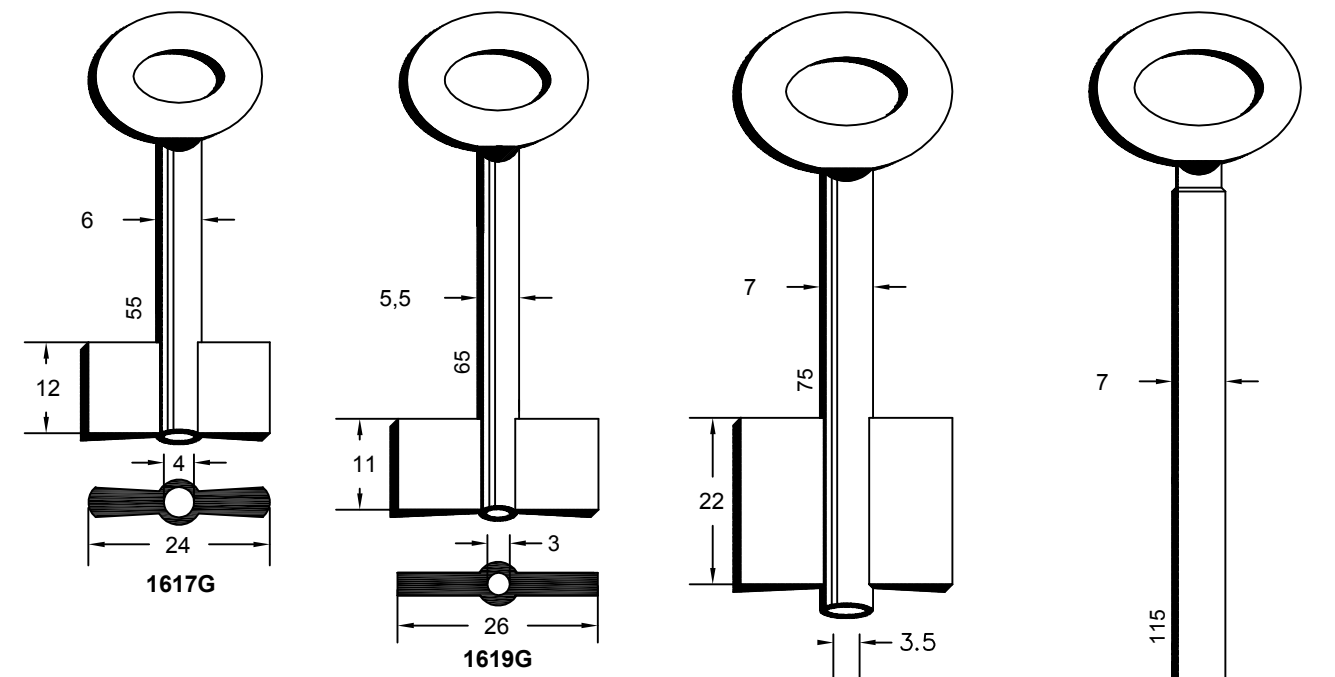
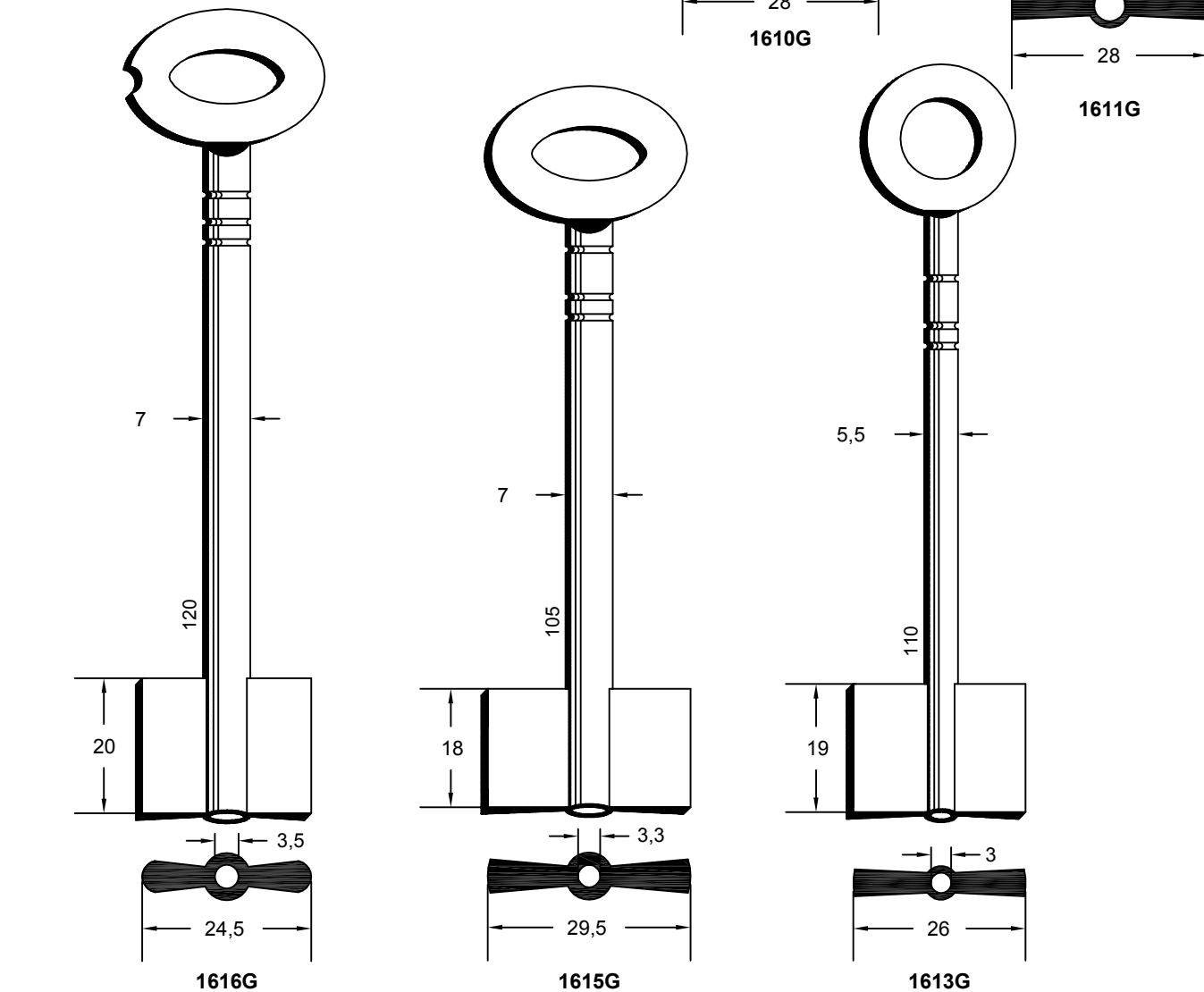
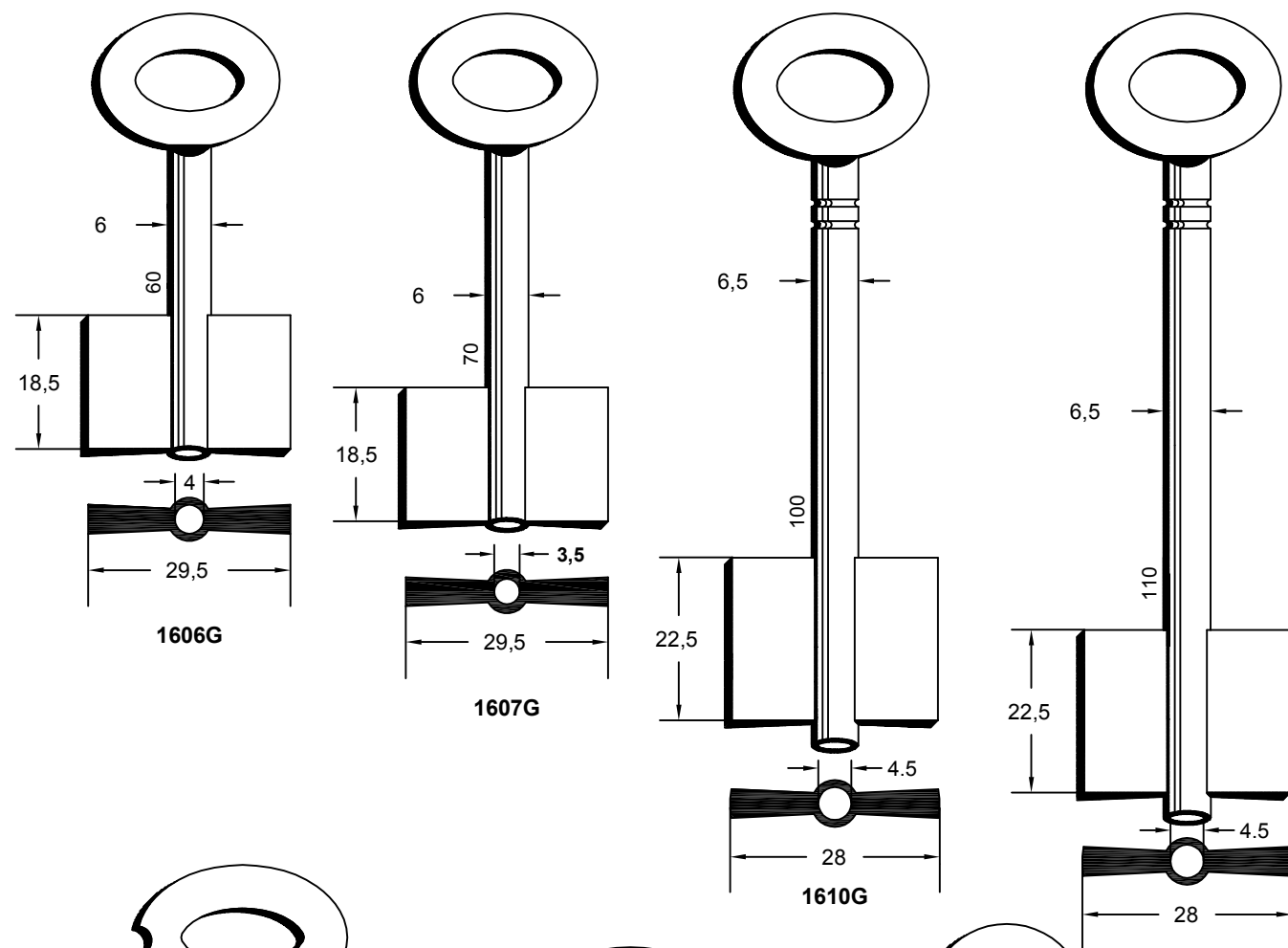

Concerning the marks and commercial denominations see legal warning.  
 Concerniente a las marcas y denominaciones comerciales ver aviso legal.  
 Marka eta izendapen komertzialiei dagokienez, ikus lege-oharra.  
 Concernant les marques et dénominations commerciales voir la note dans l'index.

**JMA** Opening the future

**JMA** Opening the future

Beziehen auf die marke und handelsname sehen sie die notiz im index.  
 Relativamente às marcas e denominações comerciais, ver aviso legal.  
 Jeśli chodzi o znaki i nazwy handlowe, patrz Informacje prawne.







# BRASS

Latón  
Latoia

Laiton  
Messing

Latão  
Mosiqdz

## MORTICE KEYS

Llaves de Gorja  
Gorja motako giltzak

Clés à gorge  
Tresor-Schlüssel

Chaves de gorja  
Klucze zasuwowe



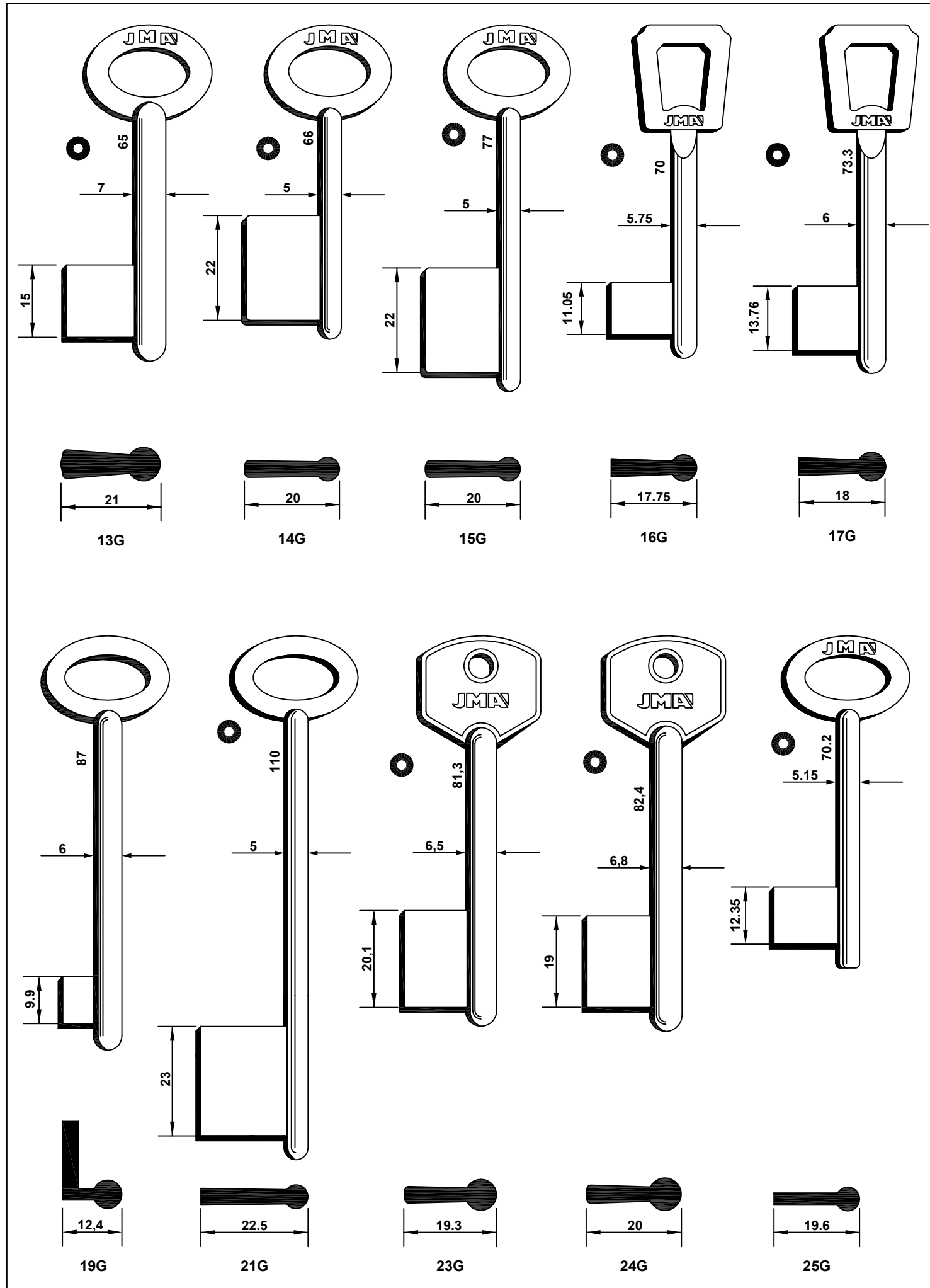
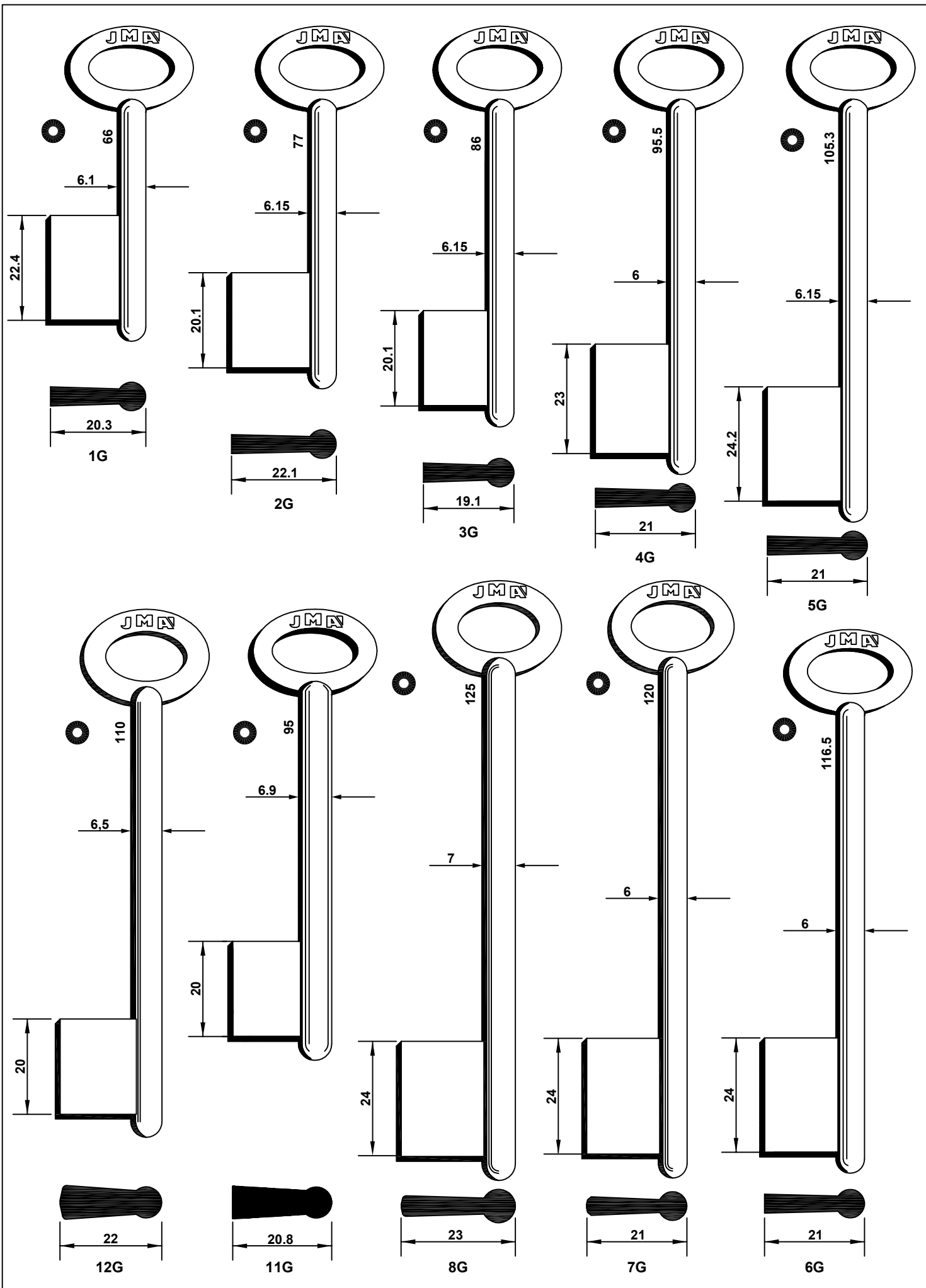

Concerning the marks and commercial denominations see legal warning.  
 Concerniente a las marcas y denominaciones comerciales ver aviso legal.  
 Marka eta izendapen komertzialiei dagokienez, ikus lege-oharra.  
 Concernant les marques et denominations commerciales voir la note dans l'index.

**JMA** Opening the future

**JMA** Opening the future

Beziehen auf die marke und handelsname sehen sie die notiz im index.  
 Relativamente às marcas e denominações comerciais, ver aviso legal.  
 Jeśli chodzi o znaki i nazwy handlowe, patrz Informacje prawne.

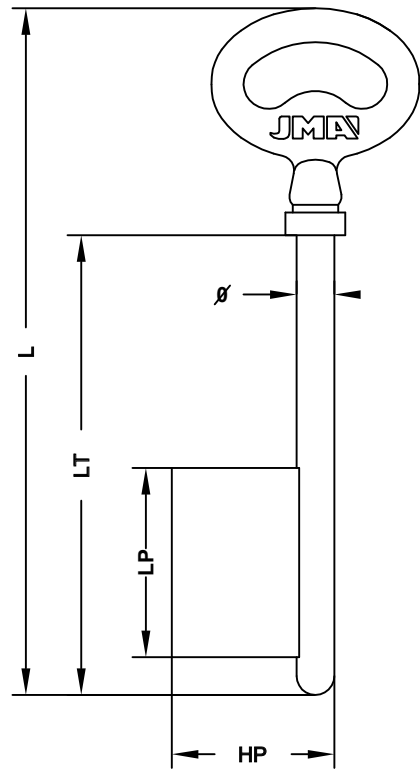

REF.	∅	L	LT	LP	HP
AD-3	5	90	60	25	21,5
AD-4	5	95	65	25	21,5
AD-5	5	100	70	25	21,5
AD-16	5	110	80	30	21,5
AD-6	5,5	80	59	25	22
AD-7	5,5	95	64	25	22
AD-18	5,5	95	64	30	22
AD-8	5,5	100	70	25	21,5
AD-19	5,5	110	80	30	22
AD-1	5,8	75	43	18	14
AD-9	5,8	80	50	25	19
AD-21	5,8	95	65	30	22
AD-10	6	90	59	25	22
AD-11	6	95	65	25	22
AD-12	6	100	70	25	22
AD-23	6	110	80	30	22
AD-24	6	120	88	35	22
AD-25	6	140	108	35	22
AD-26	6,5	95	65	30	23
AD-13	6,5	100	70	25	22
AD-29	6,5	100	70	30	23
AD-27	6,5	110	80	30	23
AD-28	6,5	120	90	35	23

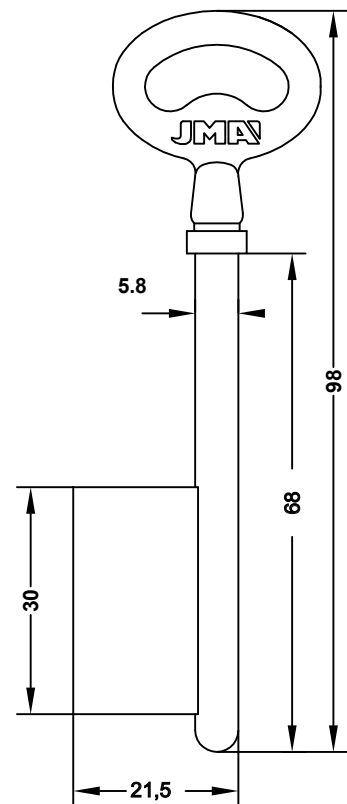

AD-2

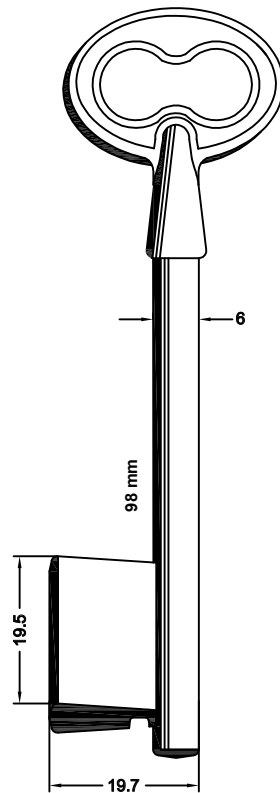

AD-44-....

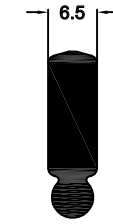
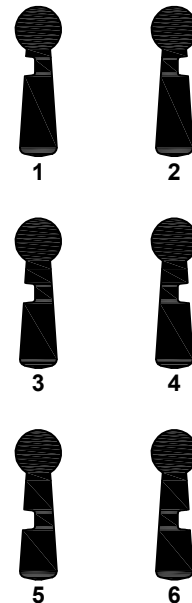

ADPLE-11

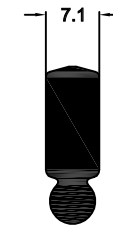
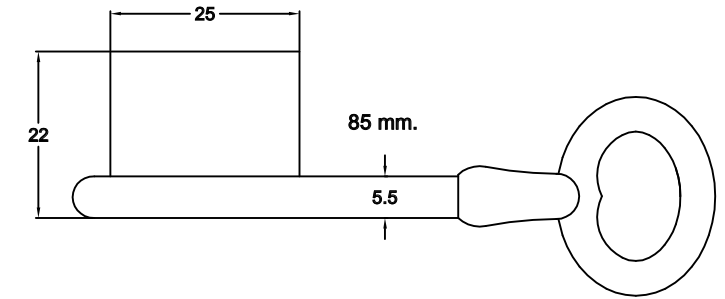

ADPLE-22

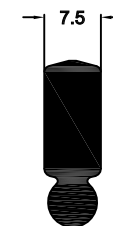
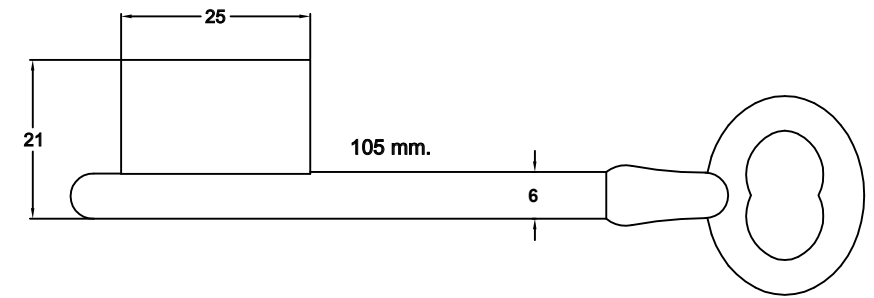

ADPLE-33

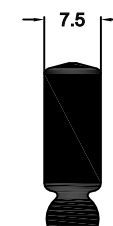
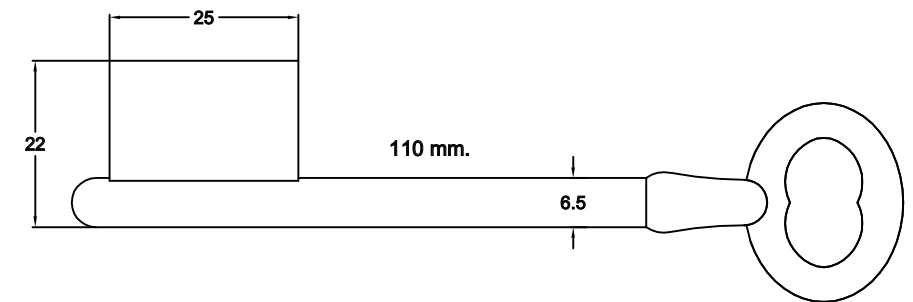

ADPLE-44

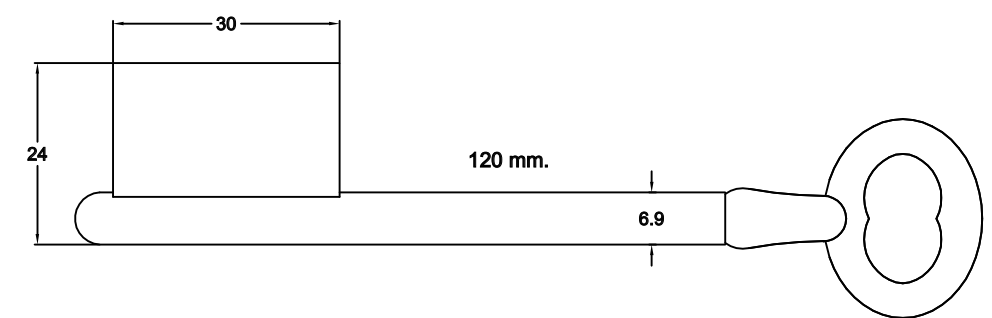

Concerning the marks and commercial denominations see legal warning.  
 Concerniente a las marcas y denominaciones comerciales ver aviso legal.  
 Marka eta izendapen komertzialiei dagokienez, ikus lege-oharra.  
 Concernant les marques et dénominations commerciales voir la note dans l'index.

**JMA** Opening the future

**JMA** Opening the future

Beziehen auf die Marke und Handelsname sehen sie die Notiz im Index.  
 Relativamente às marcas e denominações comerciais, ver aviso legal.  
 Jeśli chodzi o znaki i nazwy handlowe, patrz Informacje prawne.

FOR: 101®		FOR: 126®		
101-1G	101-2G	126H-60G	126N-60G	126PP-60G

FOR: ASSA®		FOR: BODA®		FOR: BRICARD®
AS-6G/1	AS-6G/2	BOD-4G	BOD-5G	BRI-1

FOR: 716®	FOR: AGA®	FOR: ASSA®		
716-2G 716-1G	AGA-1G	AS-1G	AS-2G	AS-3G

FOR: BRICARD®		FOR: CHUBB®
BRI-2 BRI-3		CHU-1G
BRI-6L...		CHU-1G

Concerning the marks and commercial denominations see legal warning.  
 Concerniente a las marcas y denominaciones comerciales ver aviso legal.  
 Marka eta izendapen komertzialiei dagokienez, ikus lege-oharra.  
 Concernant les marques et denominations commerciales voir la note dans l'index.



Beziehen auf die marke und handelsname sehen sie die notiz im index.  
 Relativamente às marcas e denominações comerciais, ver aviso legal.  
 Jeśli chodzi o znaki i nazwy handlowe, patrz Informacje prawne.



FOR: CHUBB®

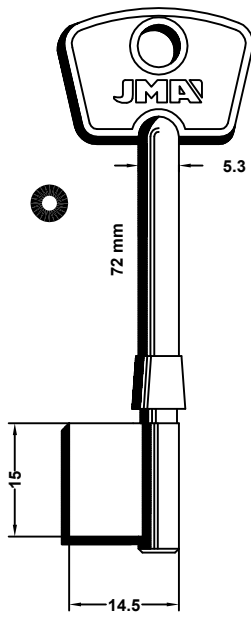

CHU-2G

FOR: DAR-MAR®

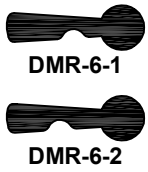
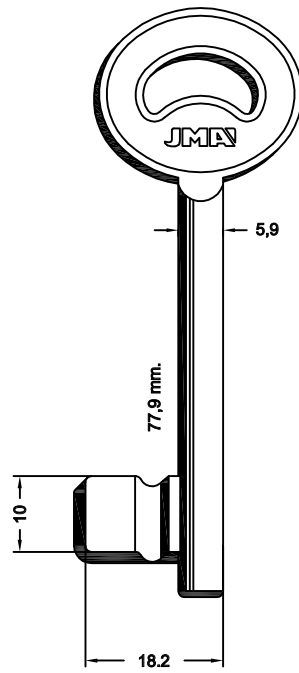

DMR-6-1  
DMR-6-2

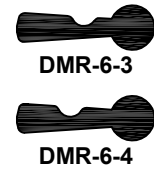
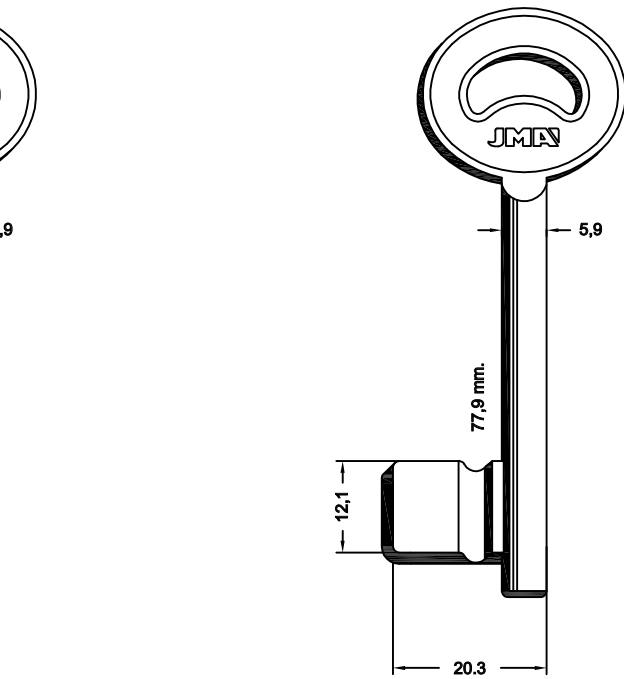

DMR-6-3  
DMR-6-4

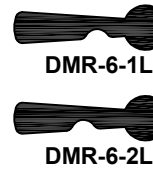
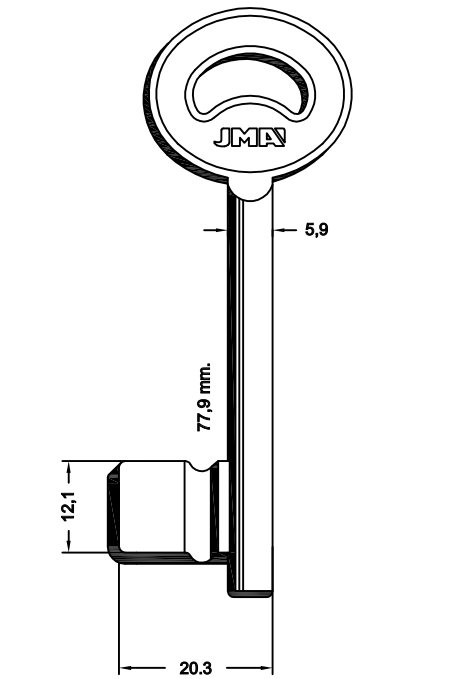

DMR-6-1L  
DMR-6-2L



DMR-6-3L  
DMR-6-4L

FOR: ELZETT®

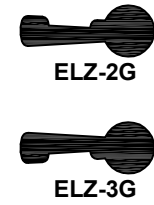
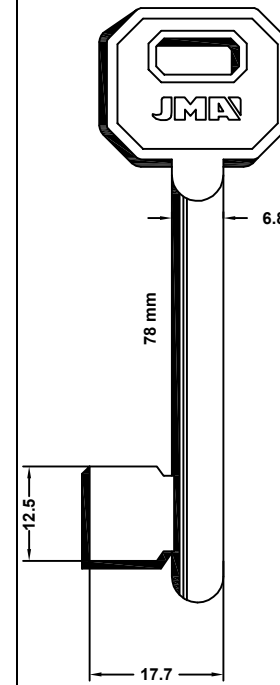

ELZ-2G  
ELZ-3G

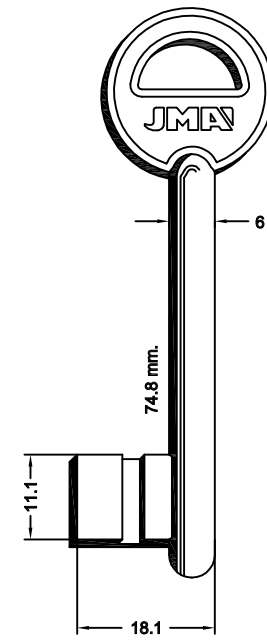

ELZ-5G  
ELZ-6G

FOR: ERA®

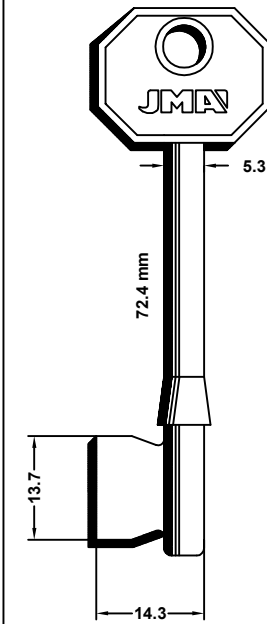

ER-1G

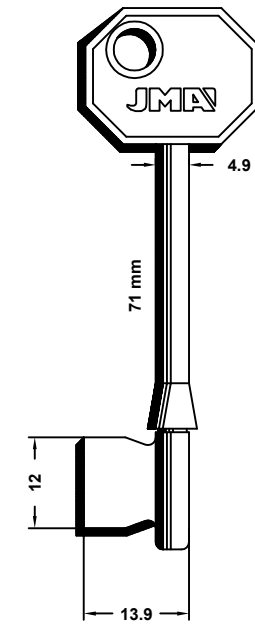

ER-4G

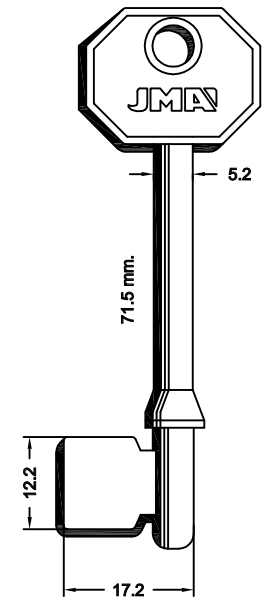

ER-5G

FOR: DAR-MAR®

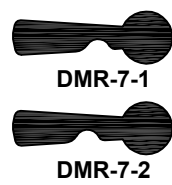
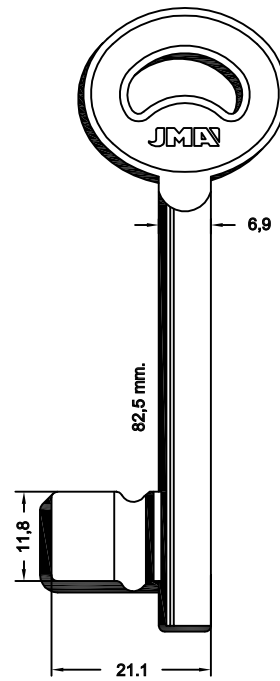

DMR-7-1  
DMR-7-2

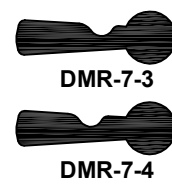

DMR-7-3  
DMR-7-4

FOR: DEBEAURAIN-ND®

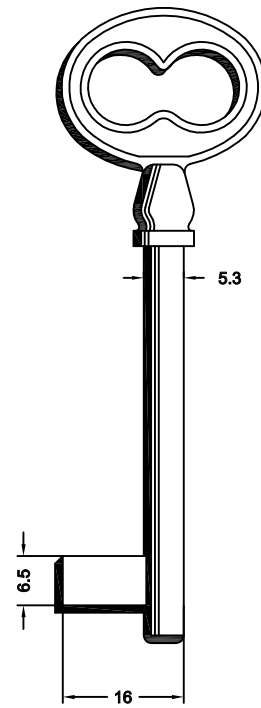

DEB-12L

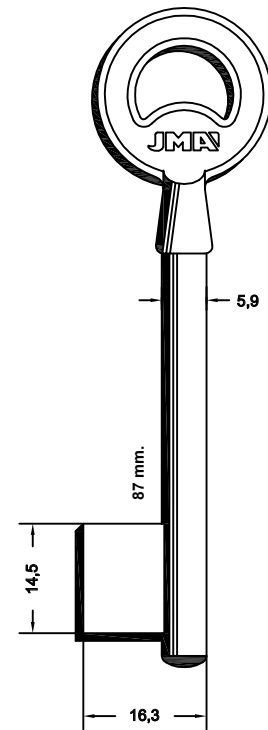

DEB-1

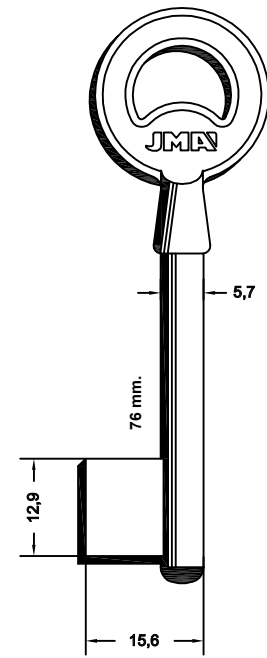

DEB-3

FOR: ESA®

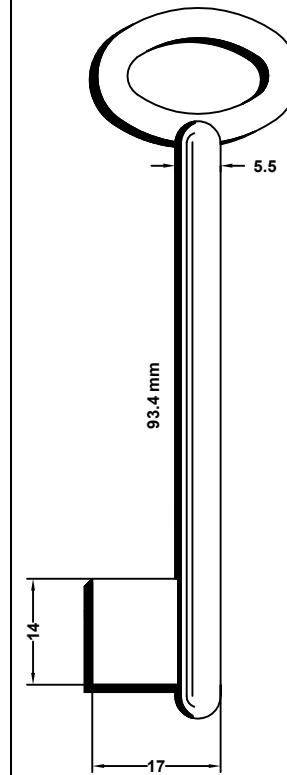

ES-1G

FOR: EUROSPEC®

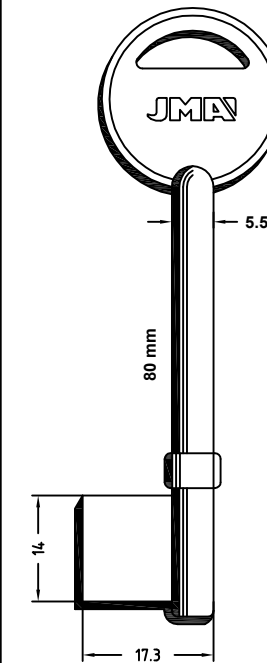

EUS-1G

FOR: FAS-YALE®

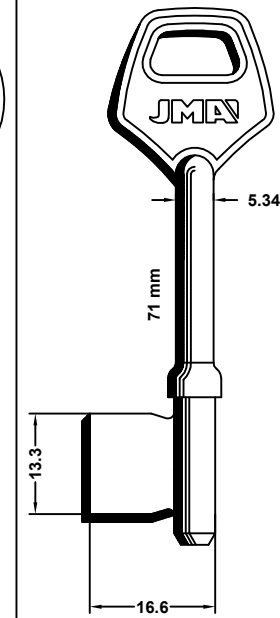

FA-1G

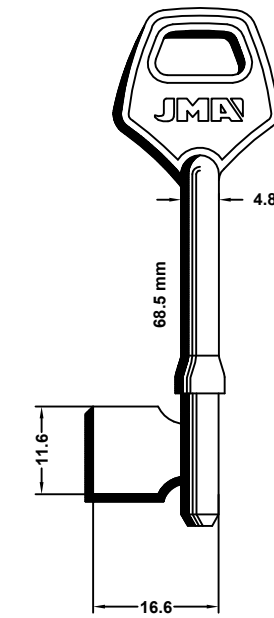

FA-2G

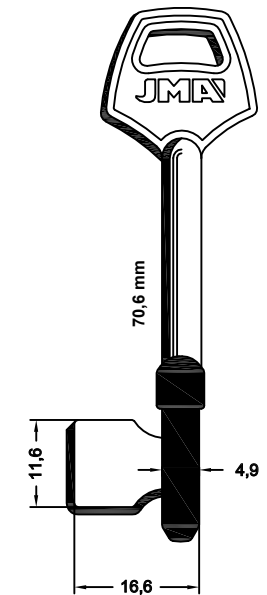

FA-2PPG

Concerning the marks and commercial denominations see legal warning.  
 Concerniente a las marcas y denominaciones comerciales ver aviso legal.  
 Marka eta izendapen komertzialiei dagokienez, ikus lege-oharra.  
 Concernant les marques et dénominations commerciales voir la note dans l'index.

FOR: FAS-YALE®

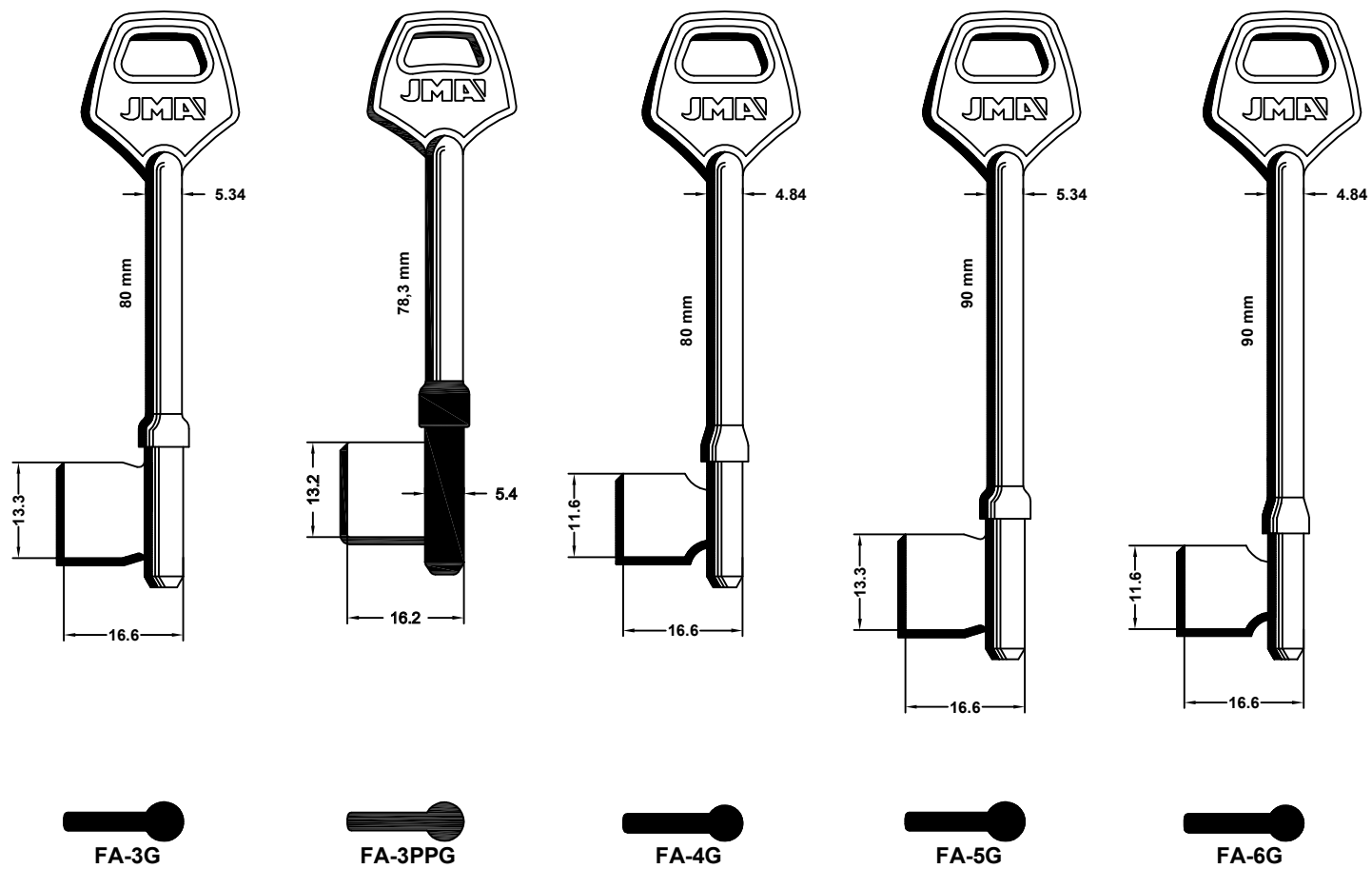

FOR: GUARDIAN®

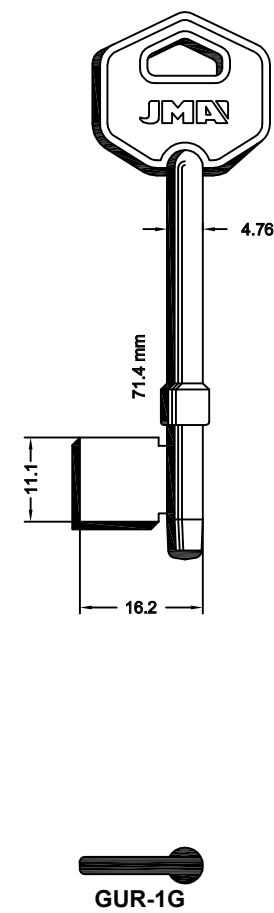

FOR: HENDERSON®

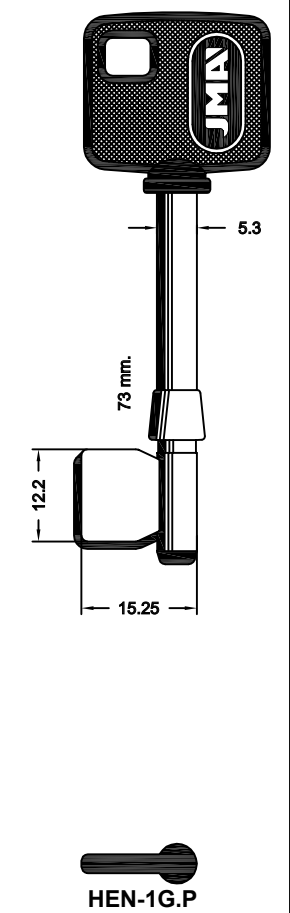

FOR: HOBES®

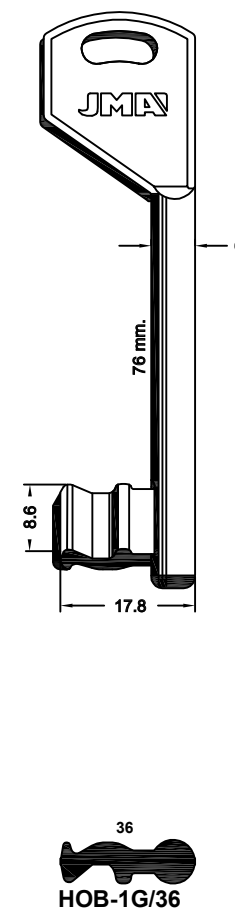

FOR: JPM®

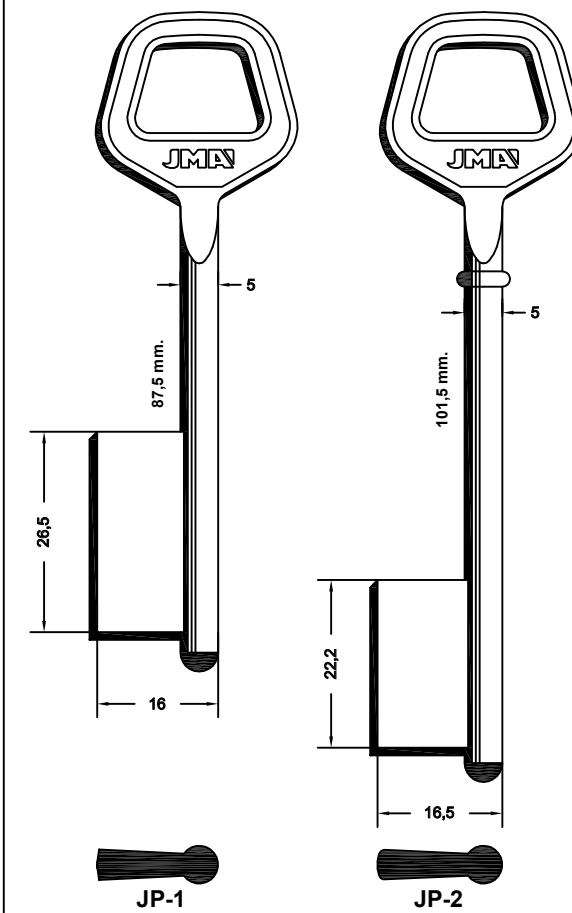

FOR: FAS-YALE®

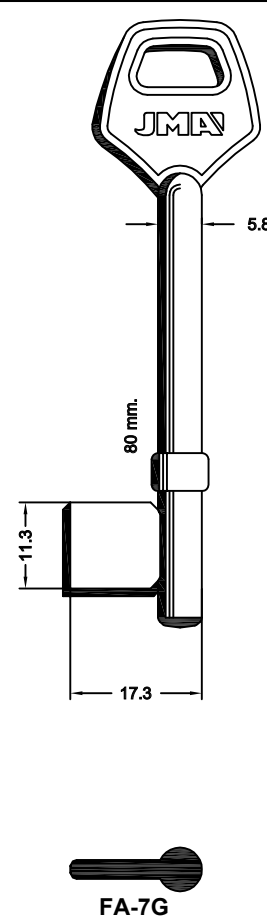

FOR: FAS®

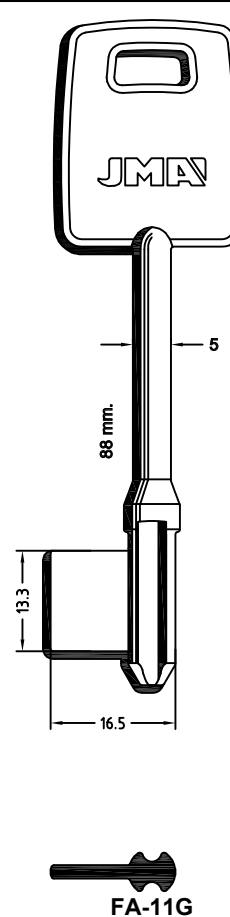

FOR: FICHET®

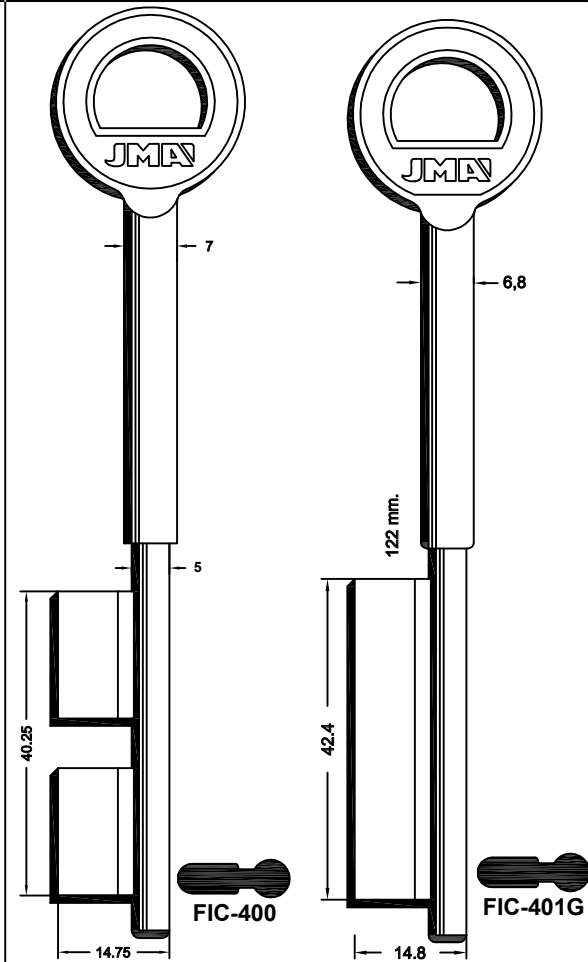

FOR: GPZ®

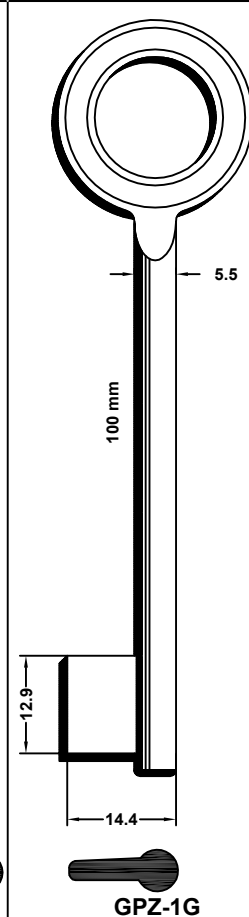

FOR: JPM®

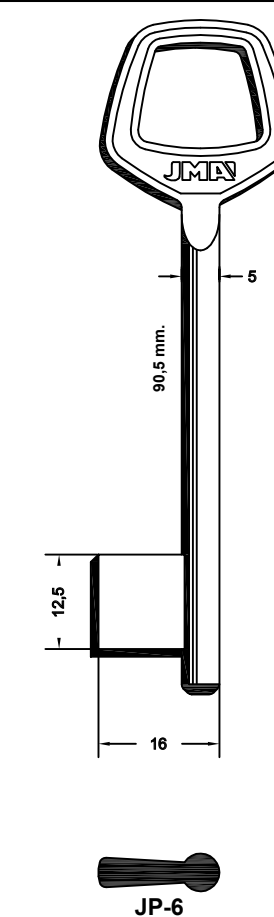
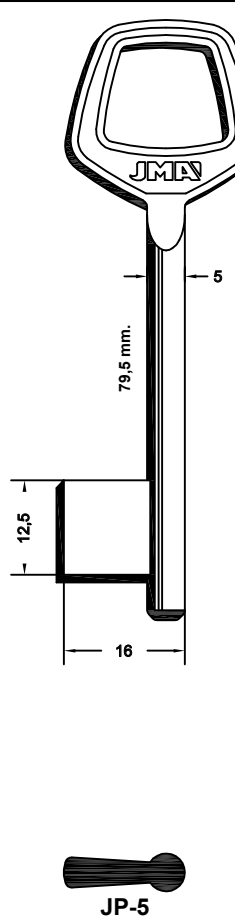
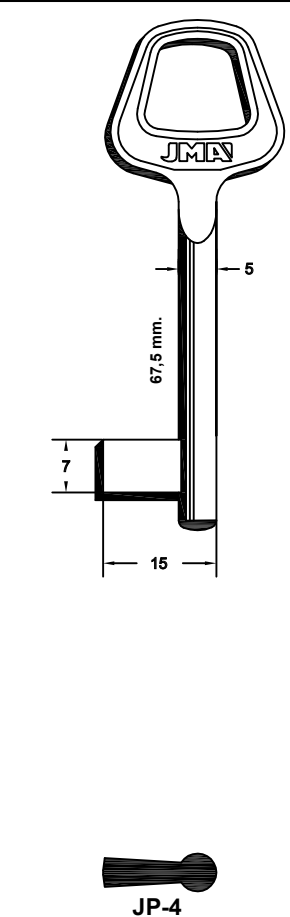
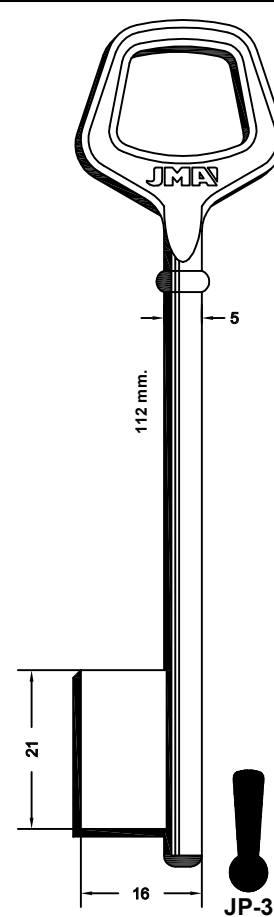

FOR: LAPERCHE®

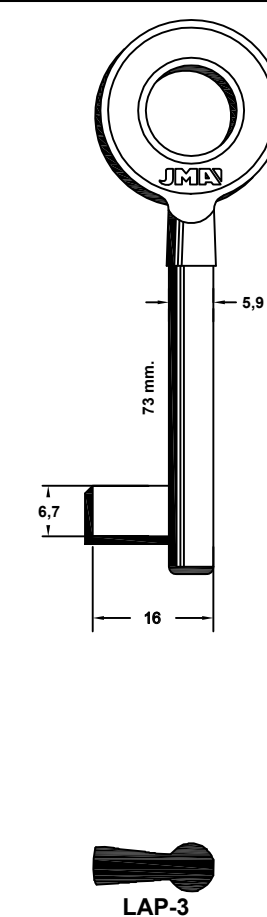

Concerning the marks and commercial denominations see legal warning.  
 Concerniente a las marcas y denominaciones comerciales ver aviso legal.  
 Marka eta izendapen komertzialiei dagokienez, ikus lege-oharra.  
 Concernant les marques et dénominations commerciales voir la note dans l'index.

**JMA** Opening the future

**JMA** Opening the future

Beziehen auf die Marke und Handelsname sehen Sie die Notiz im Index.  
 Relativamente às marcas e denominações comerciais, ver aviso legal.  
 Jeśli chodzi o znaki i nazwy handlowe, patrz Informacje prawne.

FOR: LAPERCHE®	FOR: LAR®	FOR: LÅSBOLAGET®		

FOR: MOSKVA®	FOR: MP®	FOR: ORENGO®		FOR: OSTMARK®

FOR: LÅSBOLAGET®	FOR: MAFOR®	FOR: MCM®	FOR: MOBELLA®

FOR: OSTMARK®	FOR: PASSEPARTOUT®	FOR: RENAG®	FOR: REX®												
	<table border="1"> <thead> <tr> <th></th> <th>A</th> <th>B</th> </tr> </thead> <tbody> <tr> <td>PPT-3G</td> <td>14,5</td> <td>7,6</td> </tr> <tr> <td>PPT-2G</td> <td>16,5</td> <td>7,9</td> </tr> <tr> <td>PPT-1G</td> <td>18</td> <td>7,6</td> </tr> </tbody> </table> FOR: BONAITI® -MAVE® -OASA® -PATENT® FOR: PERINO® -STIQAM®  FOR: AGB® -CORNI® -MP® -OSMET® -PATENT® FOR: SMET®  FOR: BONAITI® -ISEO® -MP®		A	B	PPT-3G	14,5	7,6	PPT-2G	16,5	7,9	PPT-1G	18	7,6		
	A	B													
PPT-3G	14,5	7,6													
PPT-2G	16,5	7,9													
PPT-1G	18	7,6													

Concerning the marks and commercial denominations see legal warning.  
 Concerniente a las marcas y denominaciones comerciales ver aviso legal.  
 Marka eta izendapen komertzialiei dagokienez, ikus lege-oharra.  
 Concernant les marques et dénominations commerciales voir la note dans l'index.

**JMA**® Opening the future

**JMA**® Opening the future

Beziehen auf die marke und handelsname sehen sie die notiz im index.  
 Relativamente às marcas e denominações comerciais, ver aviso legal.  
 Ješli chodzí o znaki i nazwy handlowe, patrz Informacje prawne.



FOR: REX®	FOR: SELECT®	FOR: TESA®		
<p>86 mm</p> <p>11.1</p> <p>16.2</p> <p>REX-2G</p>	<p>73.7 mm.</p> <p>14.5</p> <p>16</p> <p>5</p> <p>SEL-1</p>	<p>73.5 mm</p> <p>8.5</p> <p>18.25</p> <p>5.15</p> <p>TE-1G</p>	<p>62.6 mm.</p> <p>8</p> <p>16.1</p> <p>6</p> <p>TE-2G</p>	<p>71 mm</p> <p>8</p> <p>16.2</p> <p>6.15</p> <p>TE-3G</p>

FOR: TRIO-VING®				
<p>68 mm</p> <p>10.5</p> <p>12.5</p> <p>TV-5G</p>	<p>68.5 mm</p> <p>14</p> <p>20.3</p> <p>TV-14G</p>	<p>67 mm.</p> <p>13</p> <p>19</p> <p>TV-19G</p>	<p>TV-15G</p> <p>TV-16G</p>	<p>91 mm</p> <p>10.5</p> <p>12.5</p> <p>TV-21G</p>
	<p>TV-13G</p> <p>TV-14G</p>		<p>TV-17G</p> <p>TV-18G</p>	

FOR: TRIO-VING®					
<p>64 mm</p> <p>12.2</p> <p>18</p> <p>TV-1G</p>	<p>91 mm</p> <p>12.2</p> <p>18</p> <p>TV-2G</p>	<p>68 mm</p> <p>11.6</p> <p>17</p> <p>TV-3G</p>	<p>TV-7G</p> <p>TV-8G</p> <p>TV-9G</p>	<p>TV-10G</p> <p>TV-11G</p> <p>TV-12G</p>	

FOR: TRIO-VING®	FOR: UCEM®	
<p>91 mm</p> <p>11.6</p> <p>17</p> <p>TV-22G</p> <p>TV-25G</p>	<p>100 mm</p> <p>12</p> <p>21</p> <p>TV-23G</p> <p>TV-26G</p>	<p>100 mm</p> <p>15.5</p> <p>19.25</p> <p>TV-24G</p> <p>TV-27G</p>
	<p>100 mm</p> <p>20.5</p> <p>17.75</p> <p>UCEM-1G</p>	<p>100 mm</p> <p>6.5</p> <p>UCEM-2G</p> <p>UCEM-3G</p>

Concerning the marks and commercial denominations see legal warning.  
 Concerniente a las marcas y denominaciones comerciales ver aviso legal.  
 Marka eta izendapen komertzialiei dagokienez, ikus lege-oharra.  
 Concernant les marques et denominations commerciales voir la note dans l'index.

**JMA**® Opening the future

**JMA**® Opening the future

Beziehen auf die marke und handelsname sehen sie die notiz im index.  
 Relativamente às marcas e denominações comerciais, ver aviso legal.  
 Jeśli chodzi o znaki i nazwy handlowe, patrz Informacje prawne.

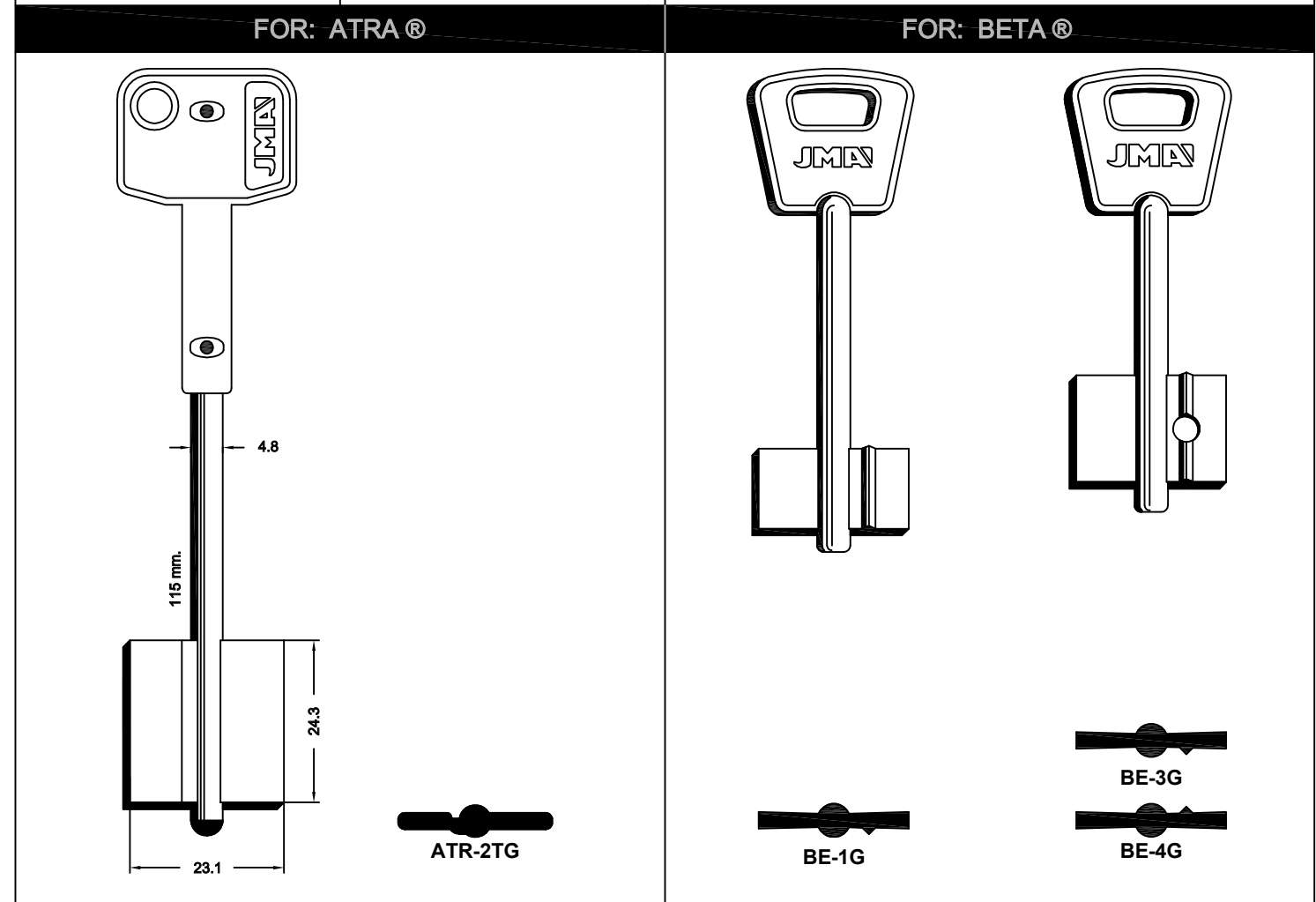
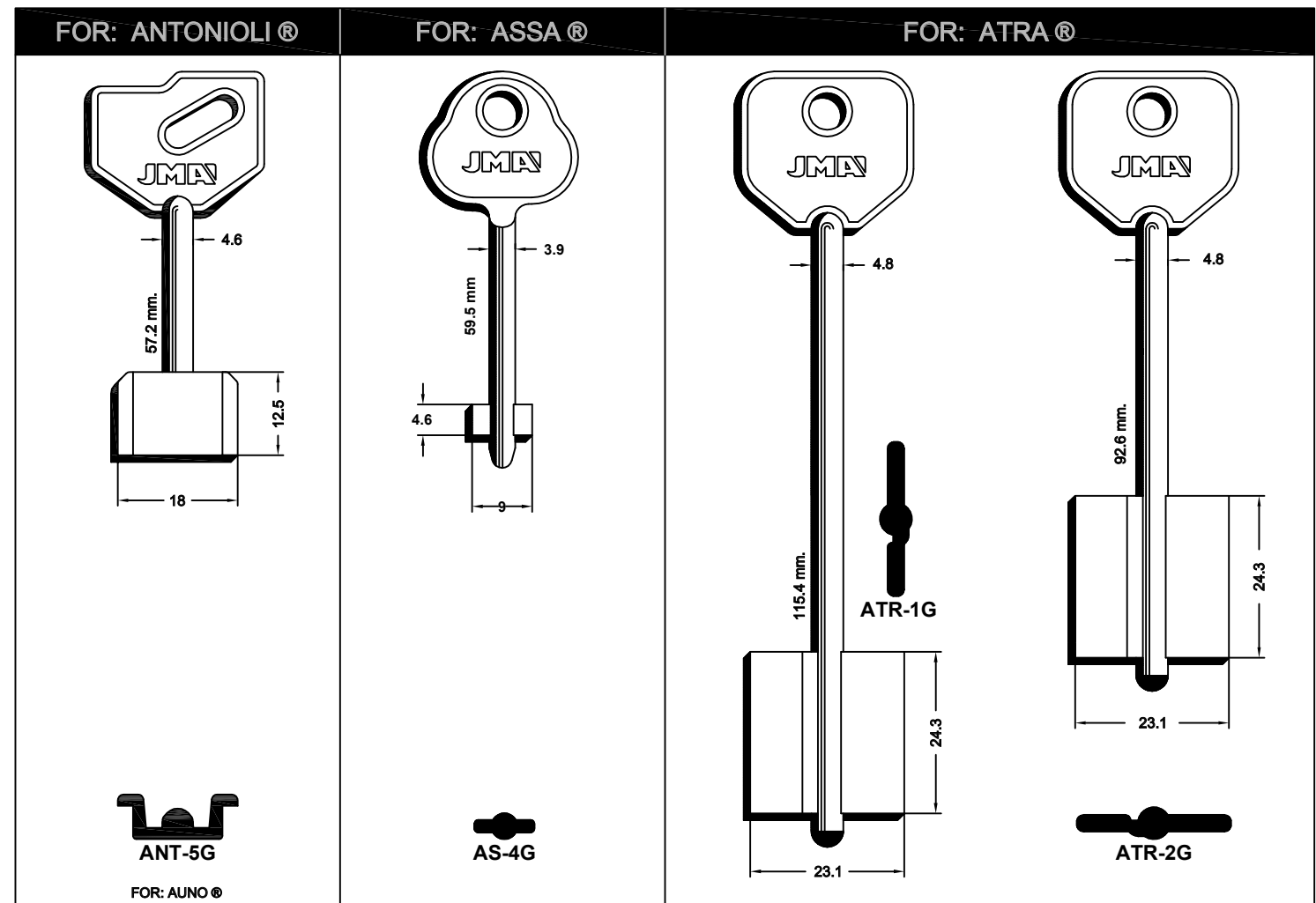
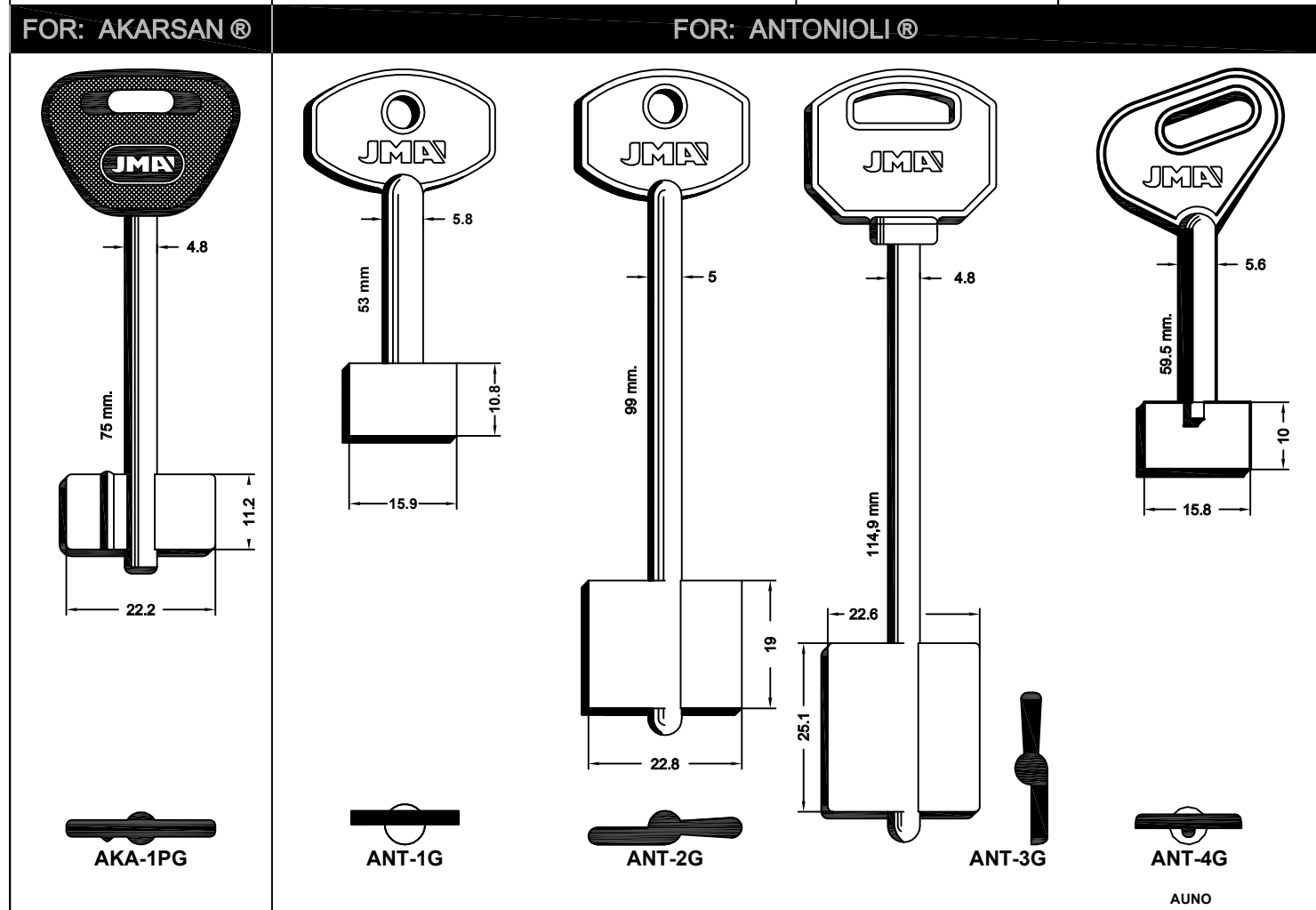
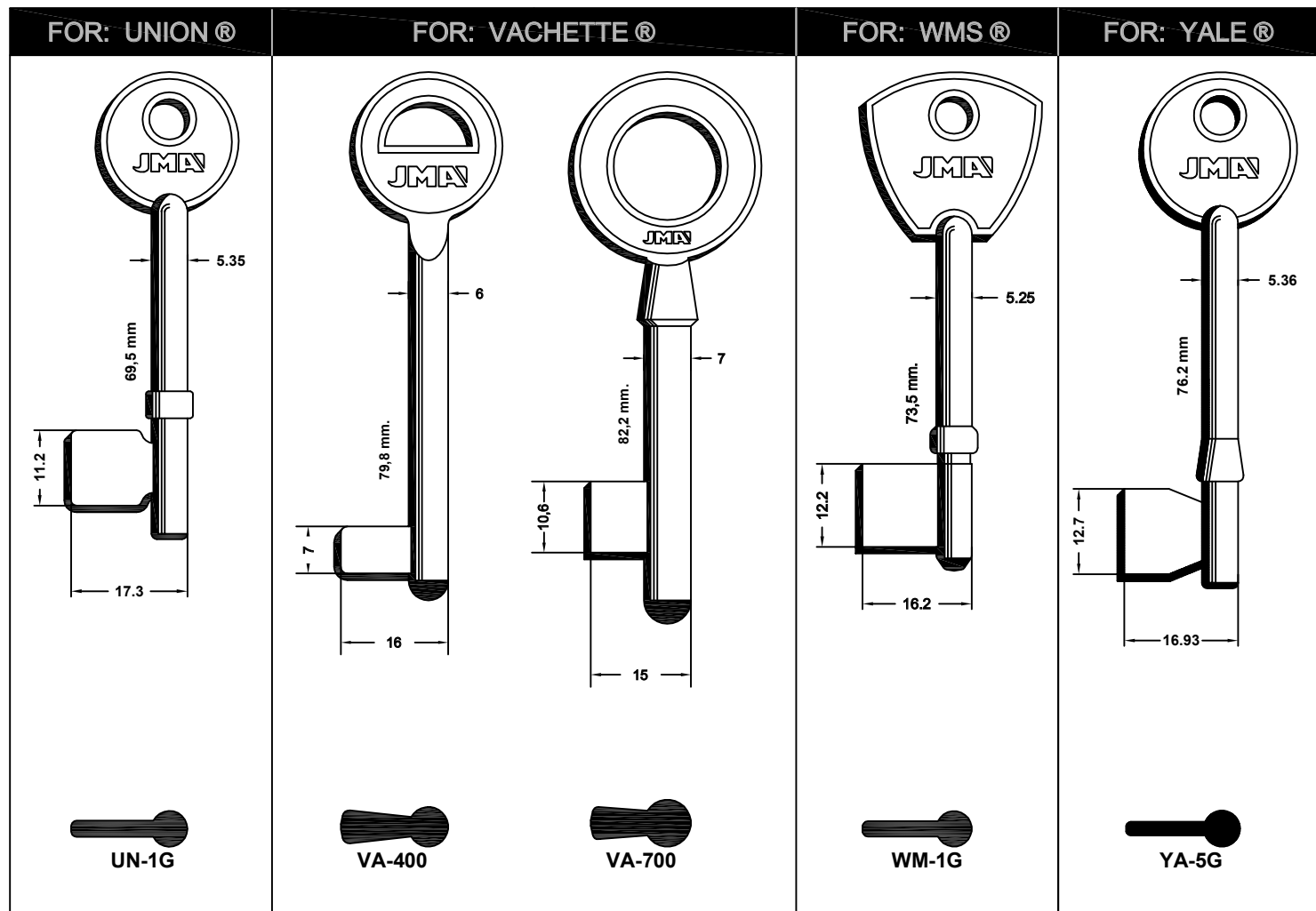

Concerning the marks and commercial denominations see legal warning.  
 Concerniente a las marcas y denominaciones comerciales ver aviso legal.  
 Marka eta izendapen komertzialiei dagokienez, ikus lege-oharra.  
 Concernant les marques et dénominations commerciales voir la note dans l'index.

**JMA®** Opening the future

**JMA®** Opening the future

Beziehen auf die marke und handelsname sehen sie die notiz im index.  
 Relativamente às marcas e denominações comerciais, ver aviso legal.  
 Jeśli chodzi o znaki i nazwy handlowe, patrz Informacje prawne.

FOR: BETA®

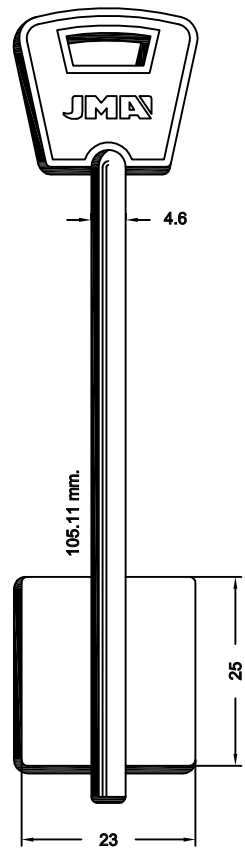

BE-5G



BE-6G

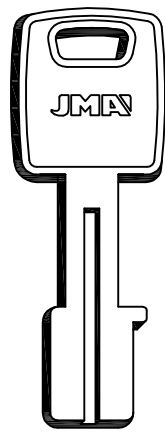

BE-7G

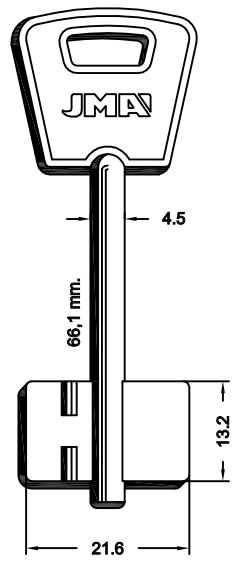

BE-10G

FOR: BMC®

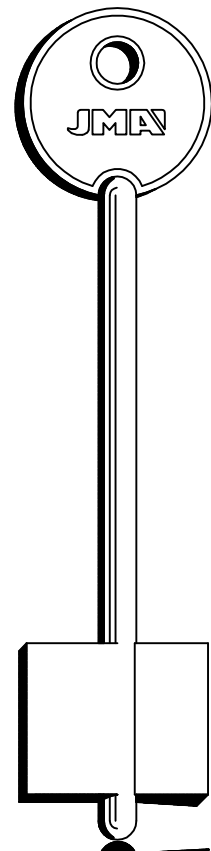

BMC-1G

FOR: BOXAFE®

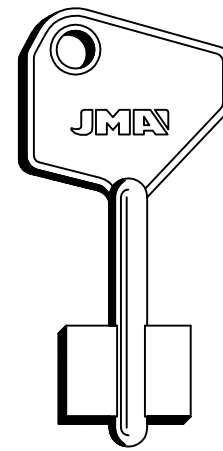

BOX-1G

FOR: CAF®

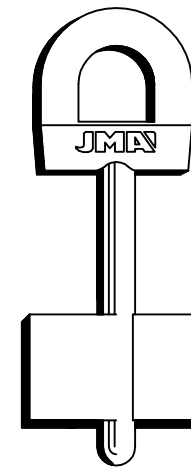

CAF-1G

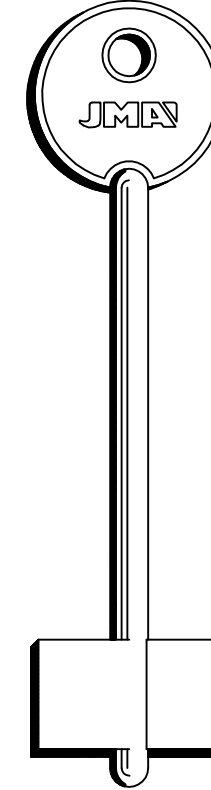

CAF-2G

FOR: CERUTTI®

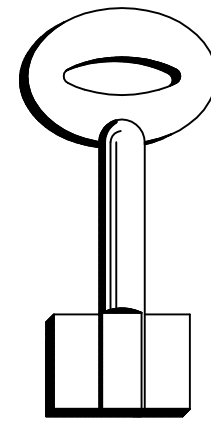

CRT-1G

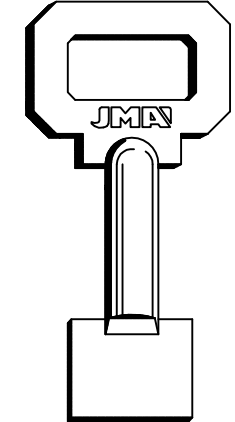

CRT-2G

FOR: BODA®

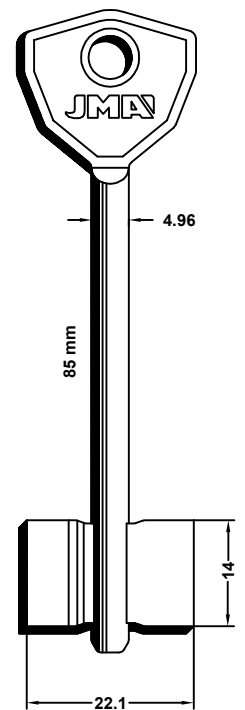

BOD-1G

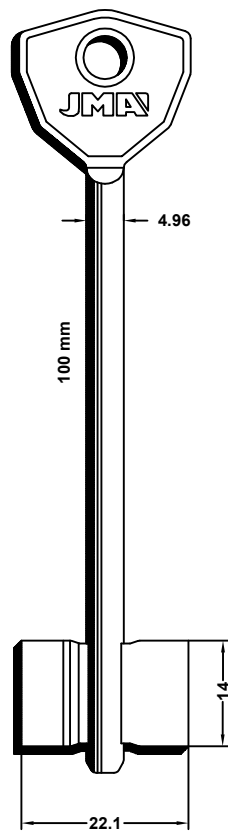

BOD-2G

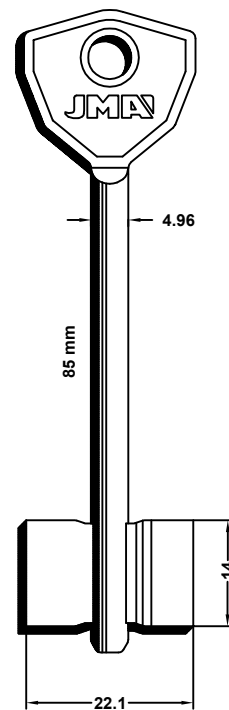

BOD-3G

FOR: BOGATIR®

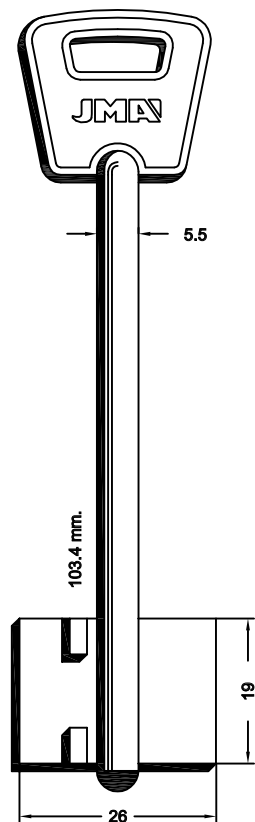

BOG-1G

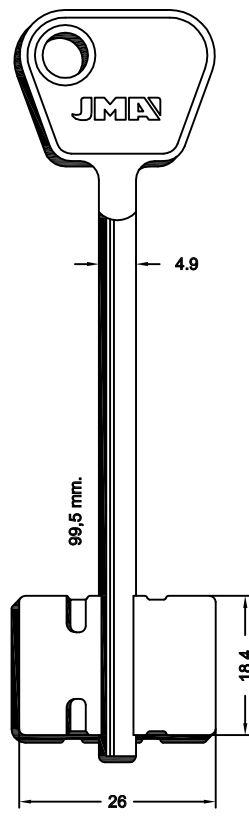

BOG-2G

FOR: CERUTTI®

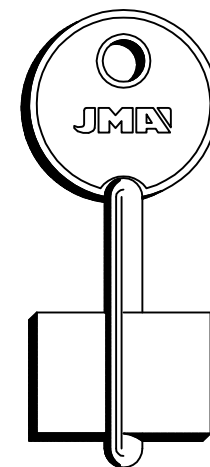

CRT-3G

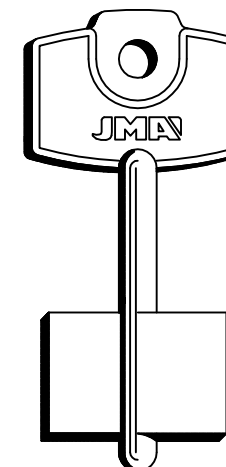

CRT-4G

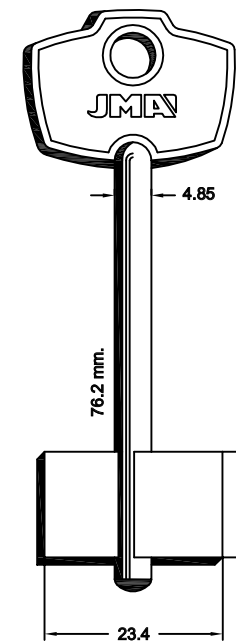

CRT-7G

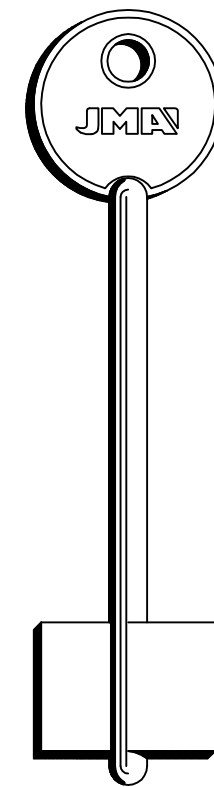

CRT-8G

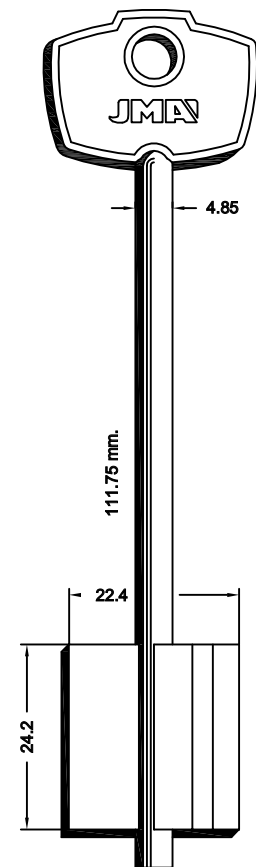

CRT-11G

Concerning the marks and commercial denominations see legal warning.  
Concerniente a las marcas y denominaciones comerciales ver aviso legal.  
Marka eta izendapen komertzialiei dagokienez, ikus lege-oharra.  
Concernant les marques et dénominations commerciales voir la note dans l'index.



FOR: CERUTTI®

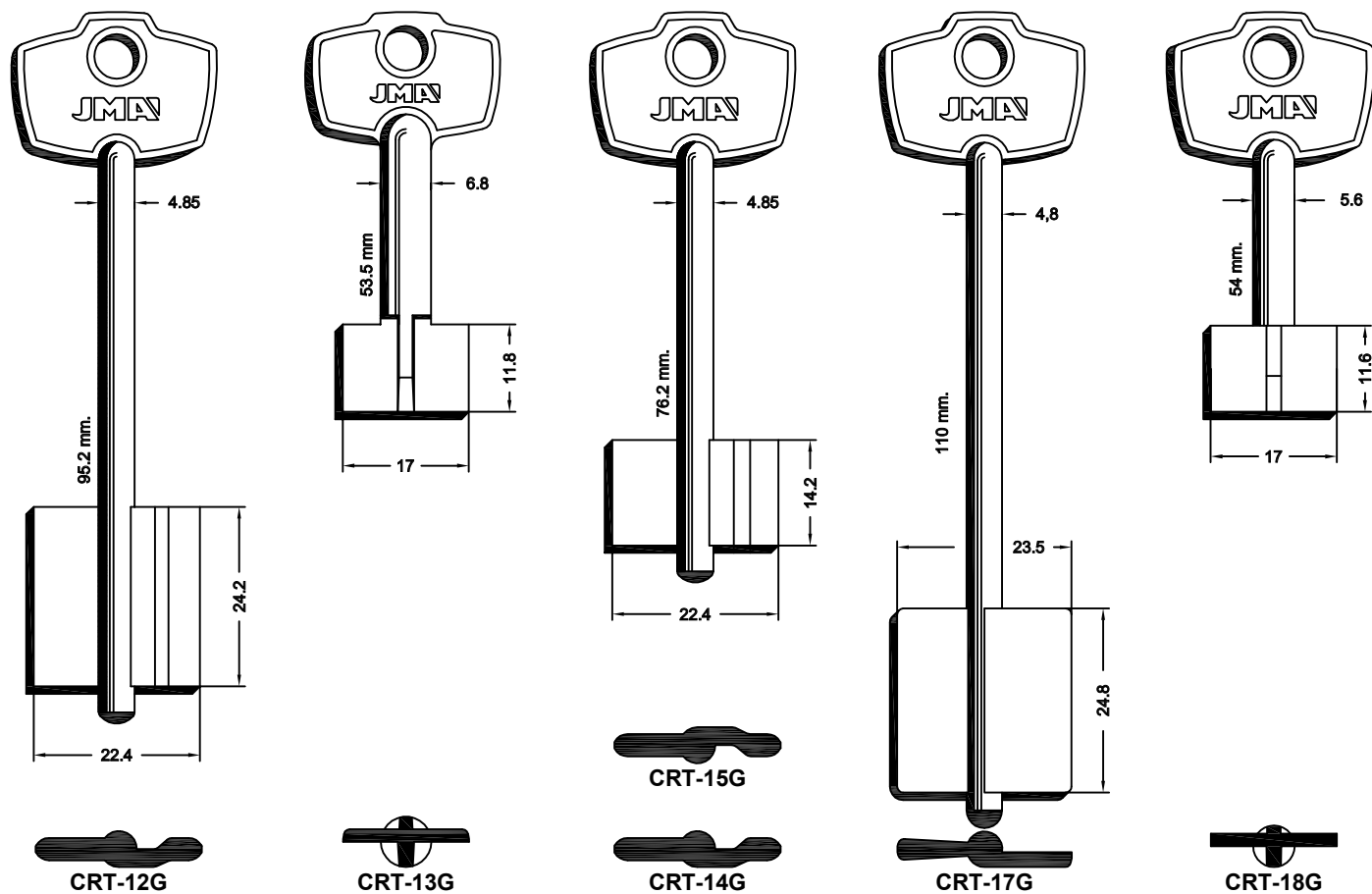

FOR: CISA®

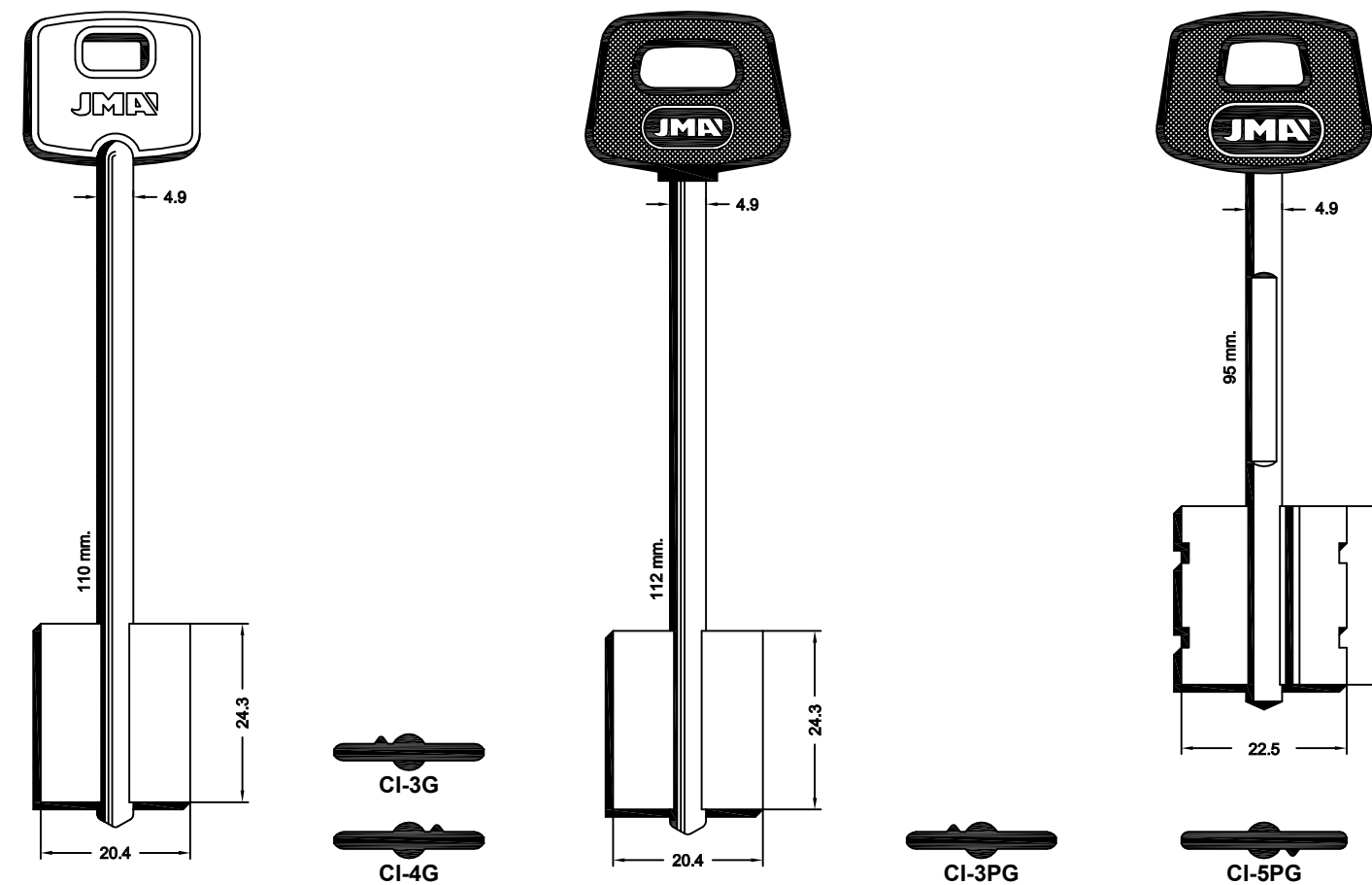

FOR: CHUBB®

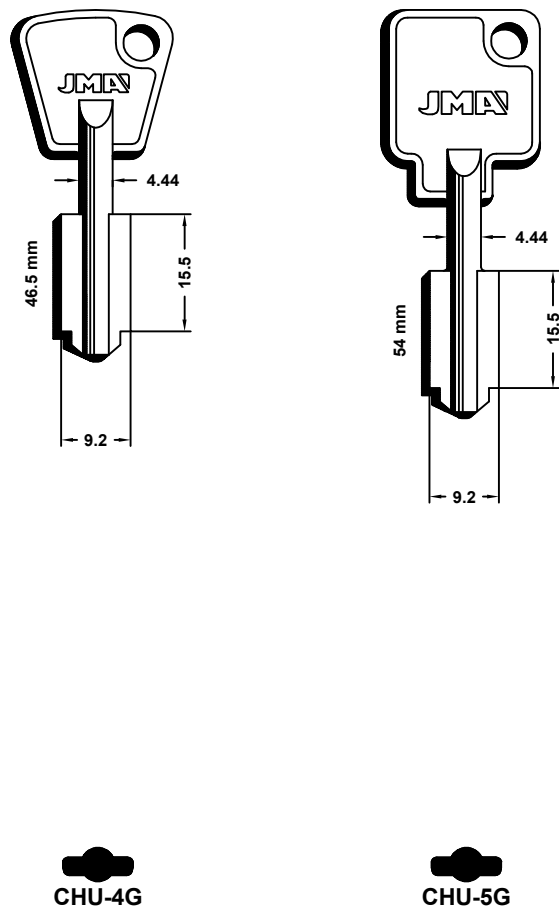

FOR: CISA®

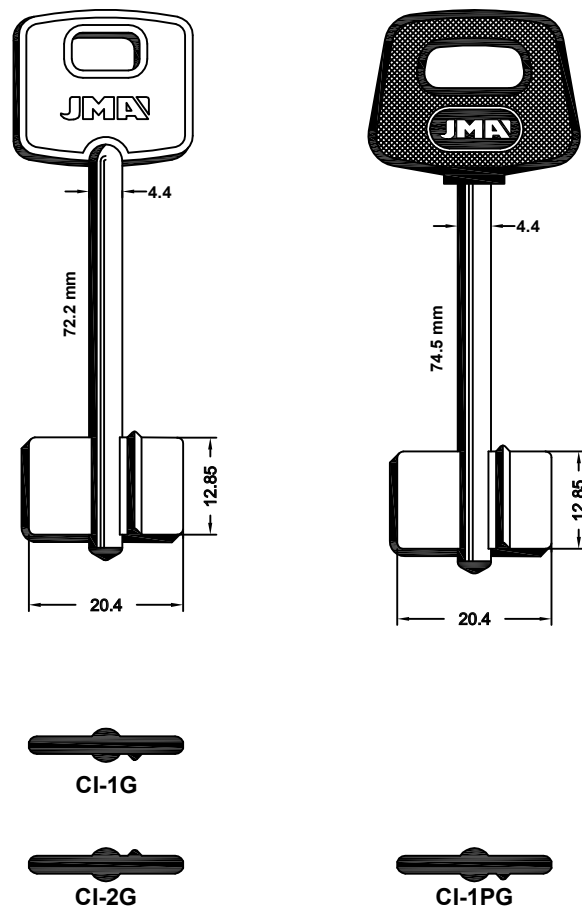

FOR: CISA®

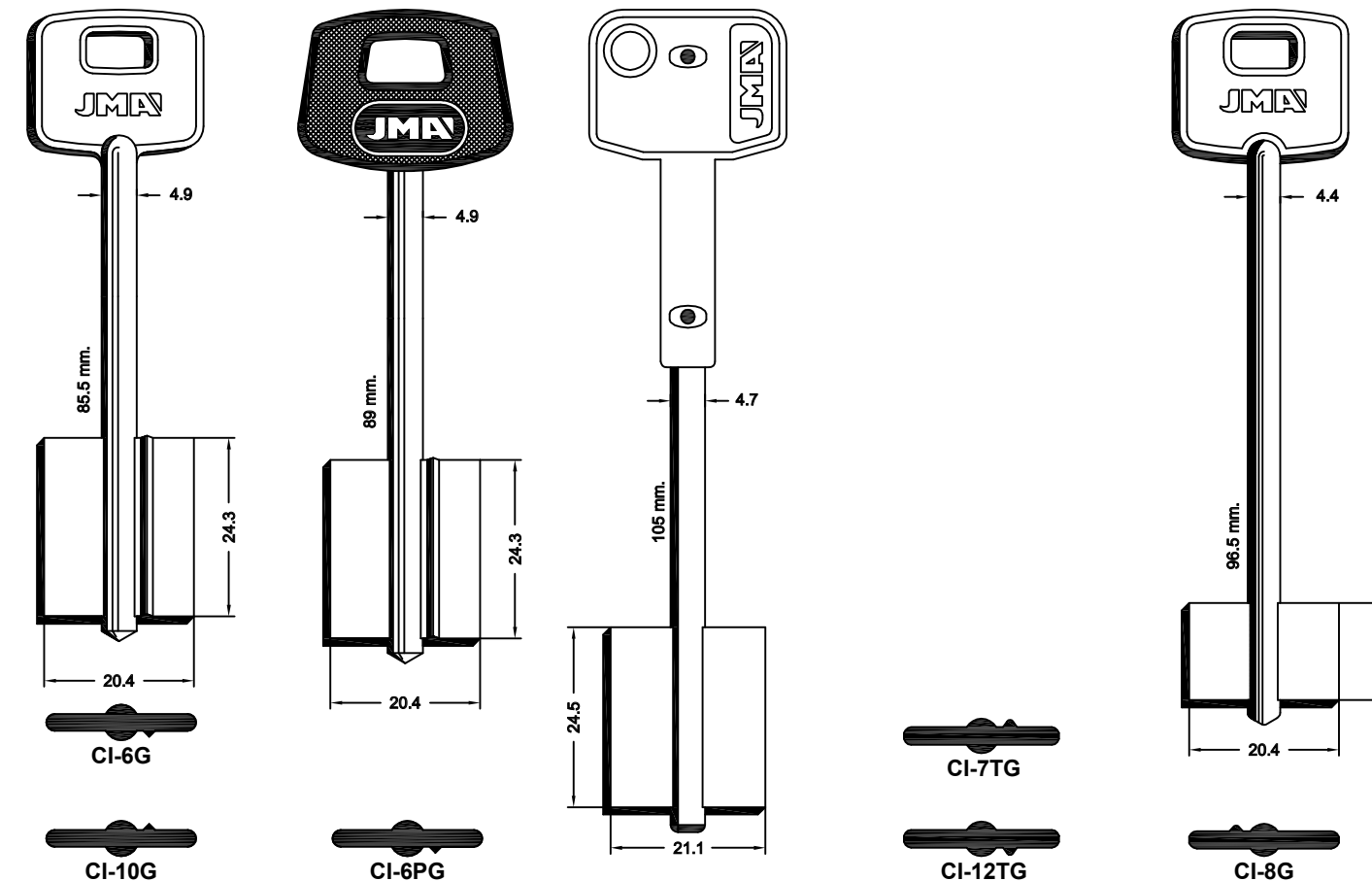

Concerning the marks and commercial denominations see legal warning.  
 Concerniente a las marcas y denominaciones comerciales ver aviso legal.  
 Marka eta izendapen komertzialiei dagokienez, ikus lege-oharra.  
 Concernant les marques et dénominations commerciales voir la note dans l'index.

FOR: CISA®

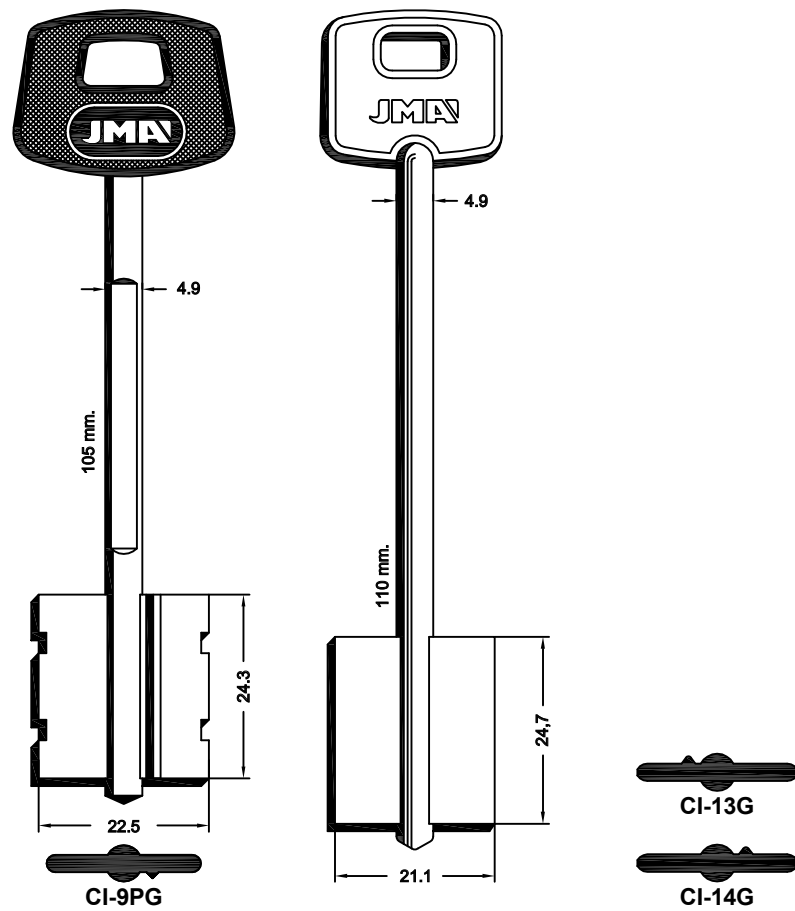

FOR: CLASS®

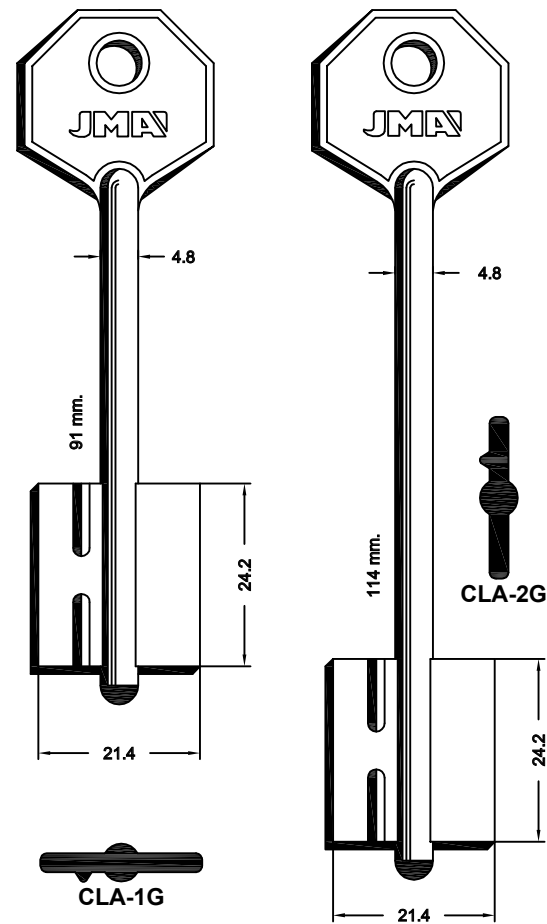

FOR: CR®

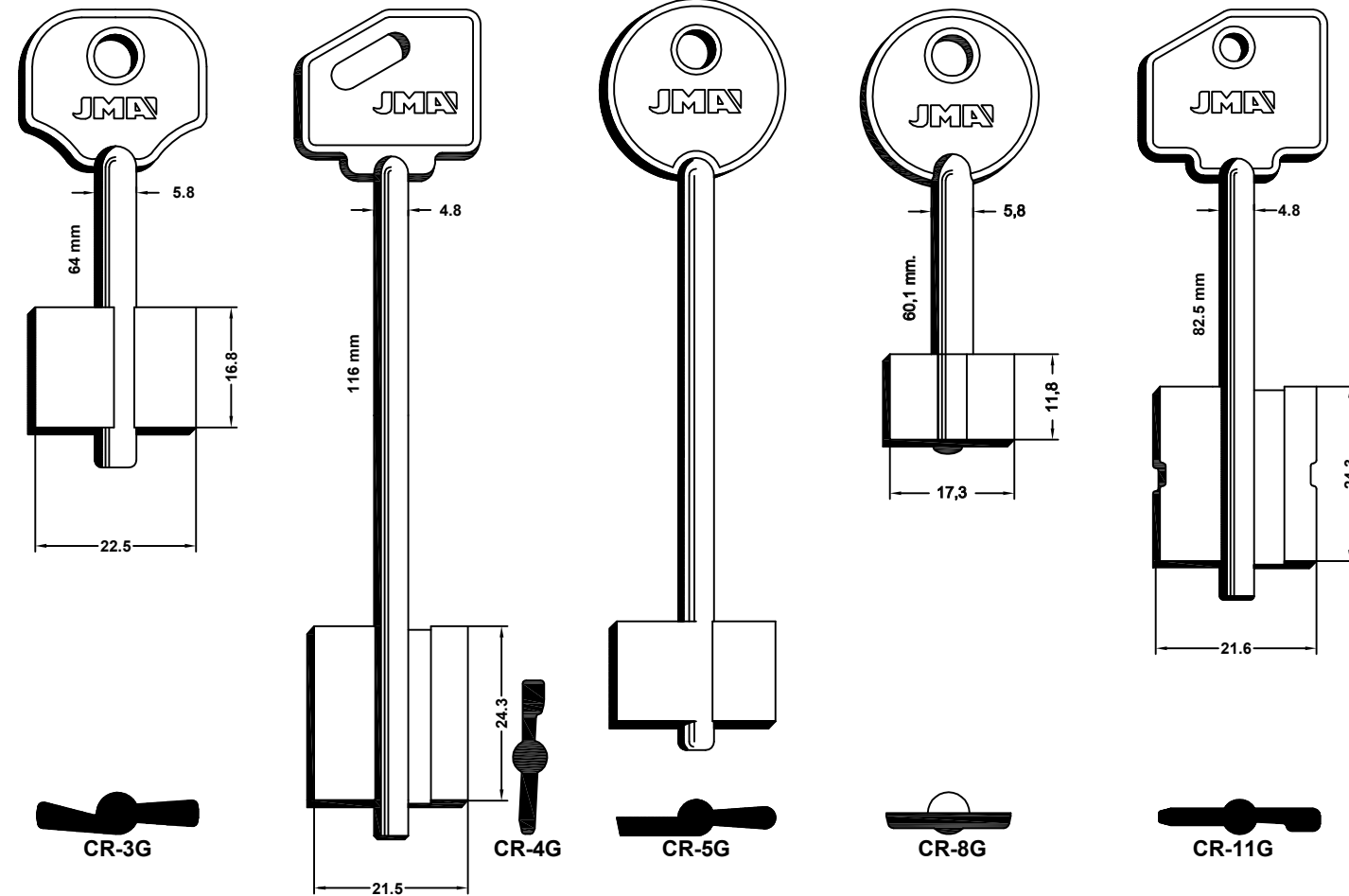

FOR: CLASS®

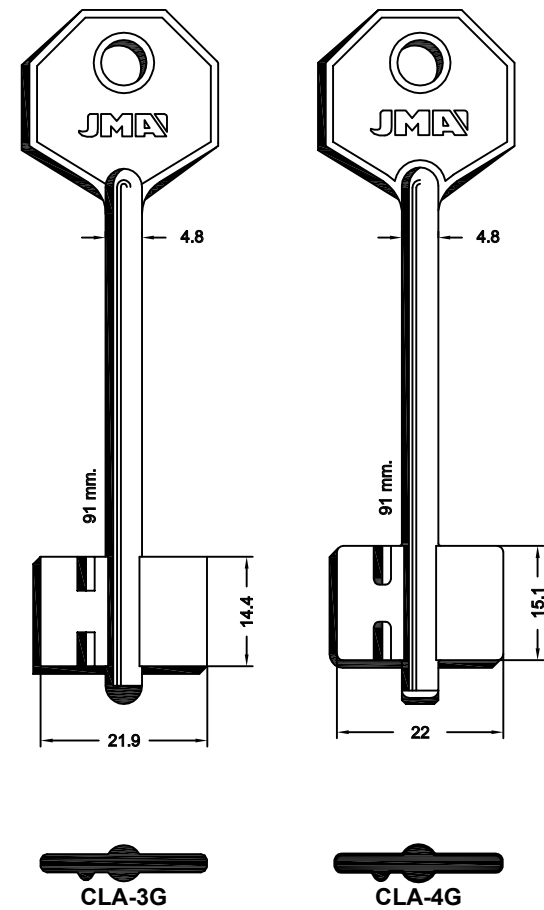

FOR: CORNI®

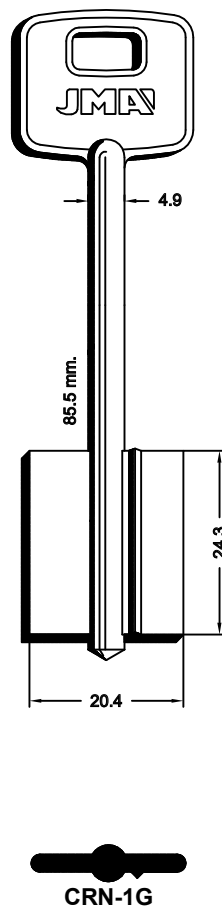

FOR: CR®

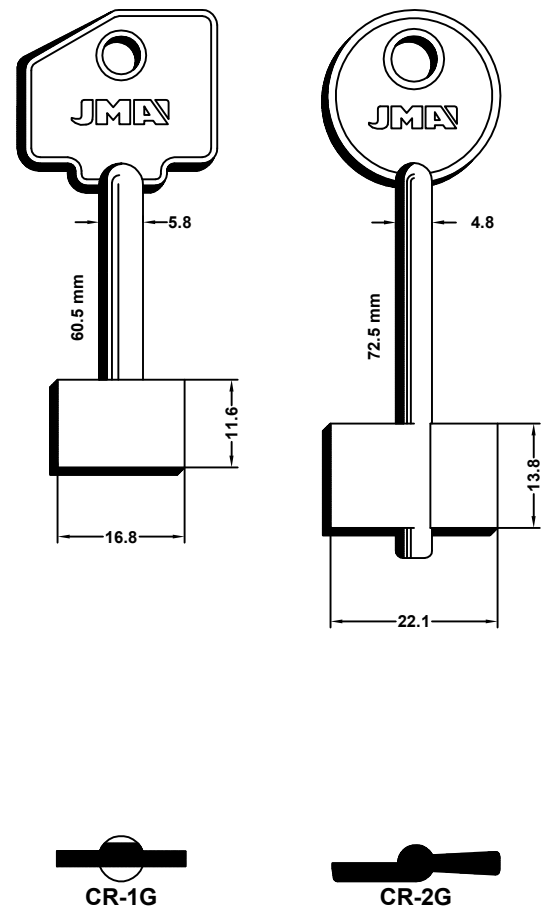

FOR: CR®

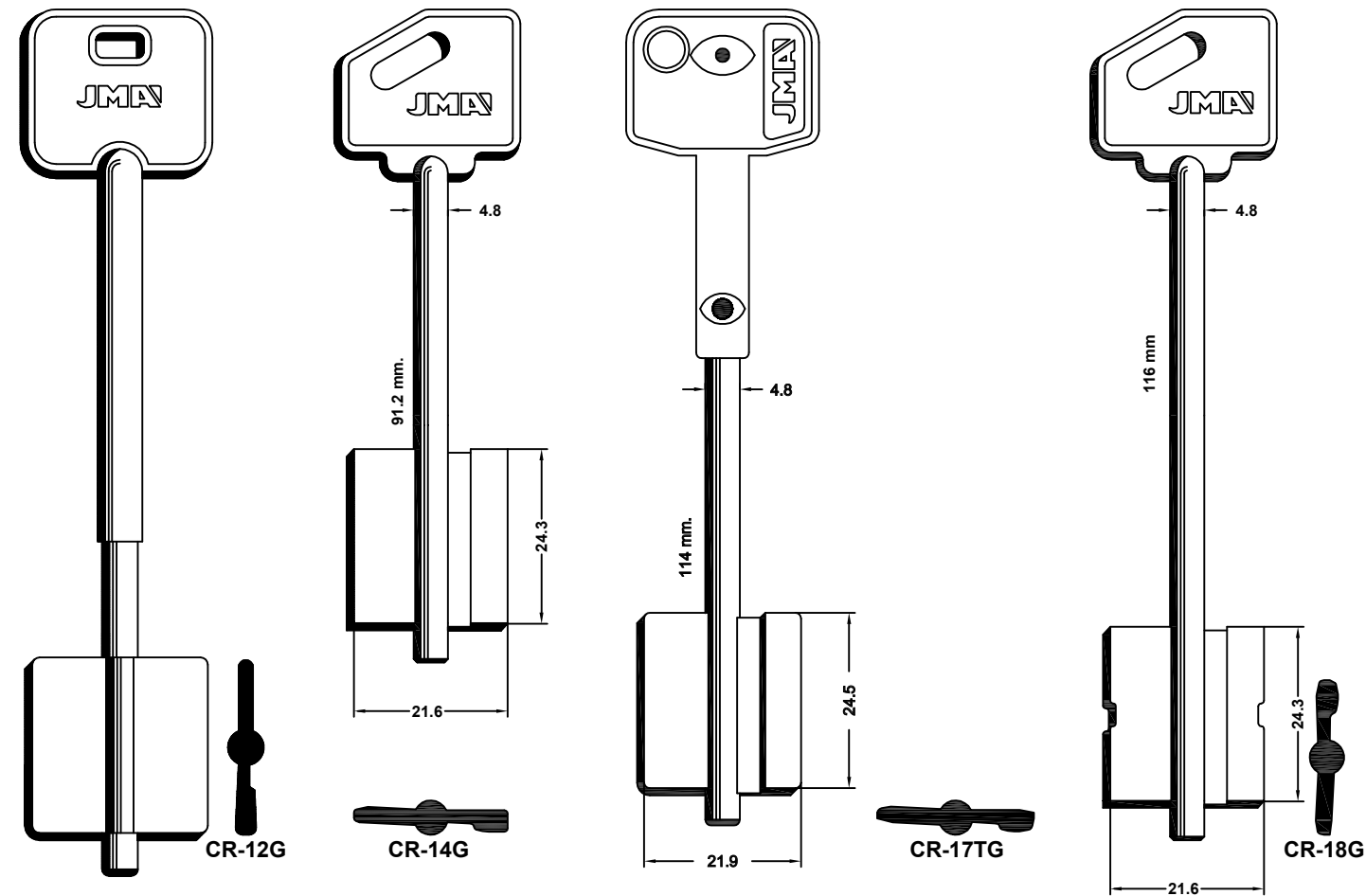

Concerning the marks and commercial denominations see legal warning.  
 Concerniente a las marcas y denominaciones comerciales ver aviso legal.  
 Marka eta izendapen komertzialiei dagokienez, ikus lege-oharra.  
 Concernant les marques et dénominations commerciales voir la note dans l'index.

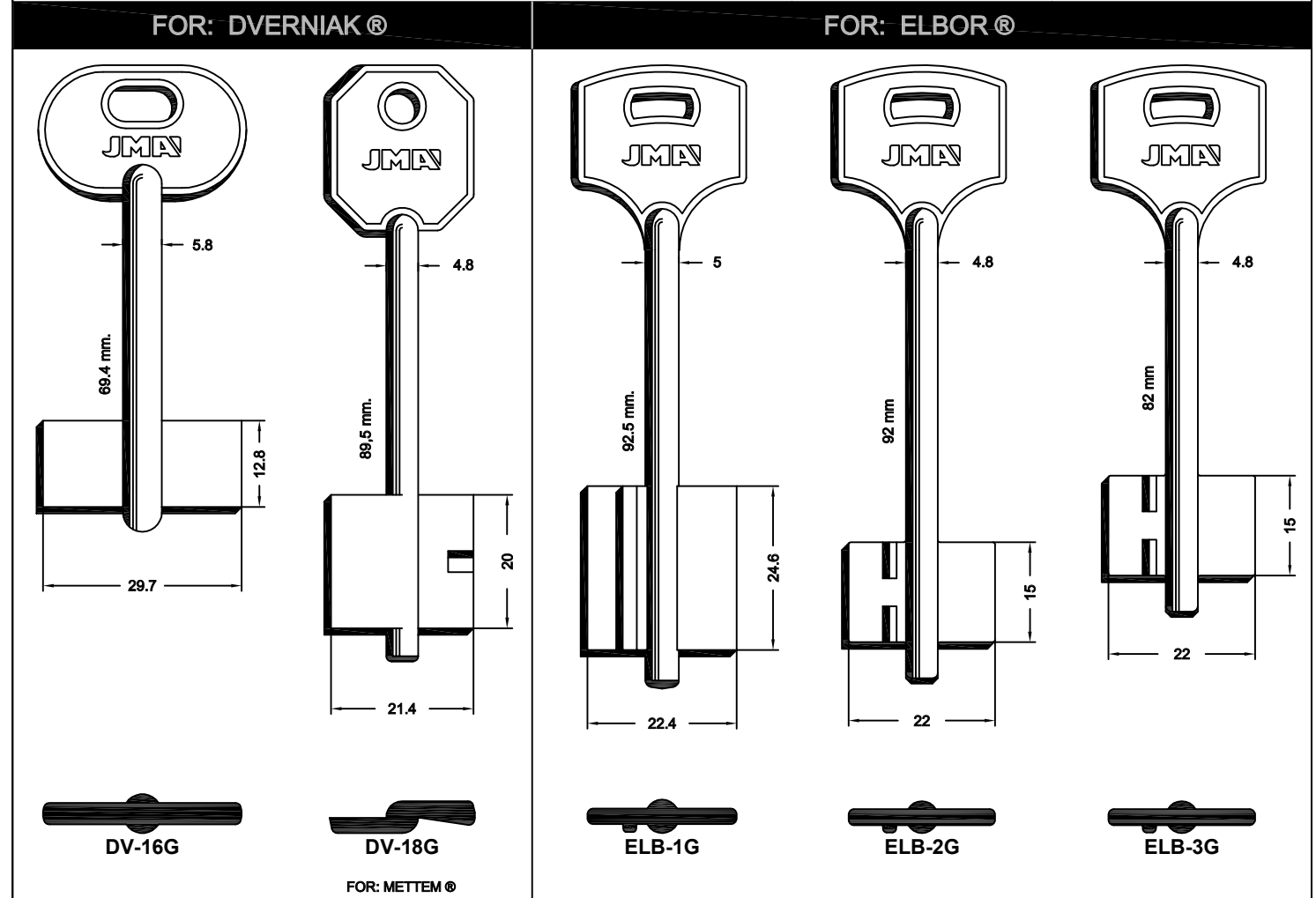
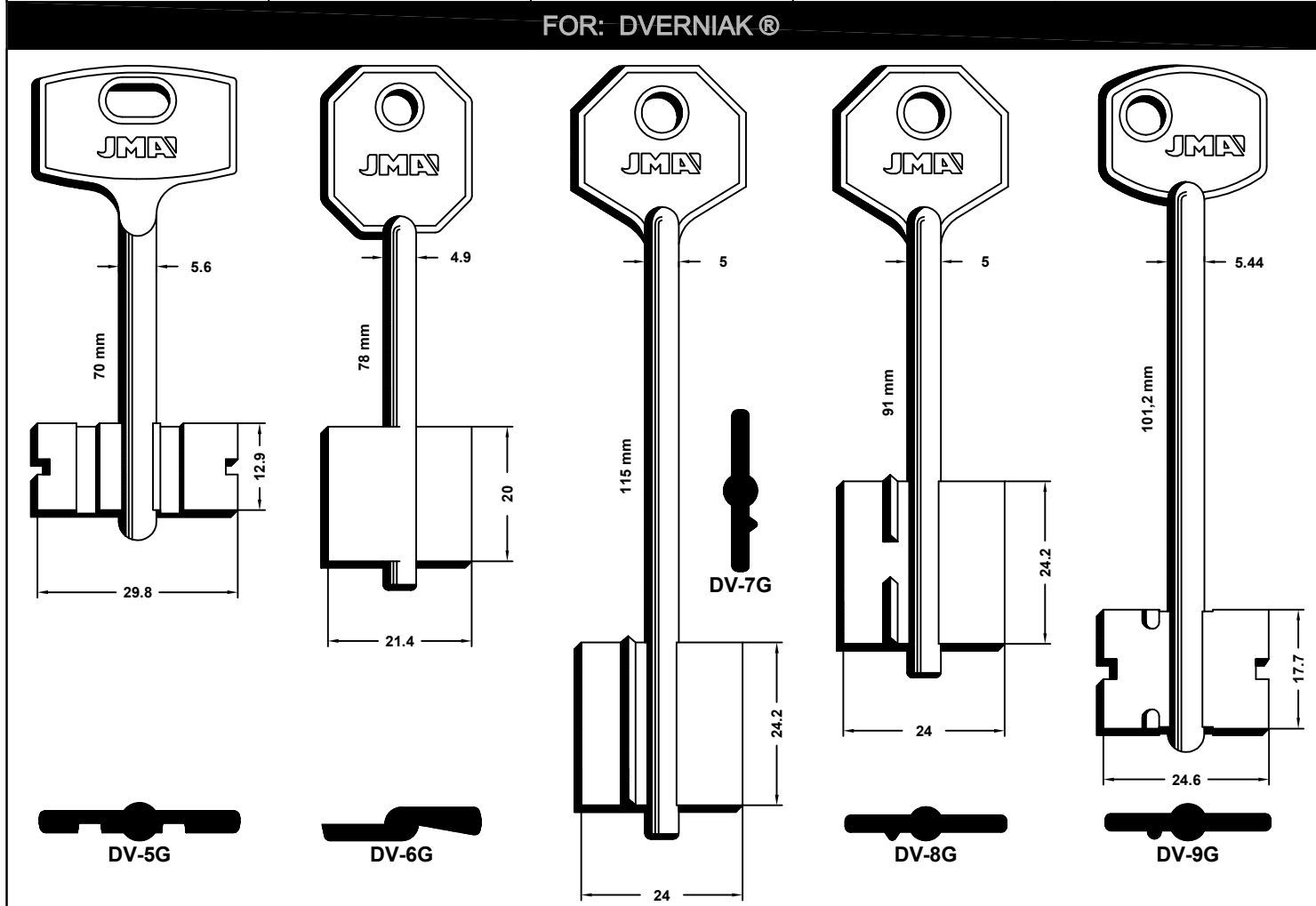
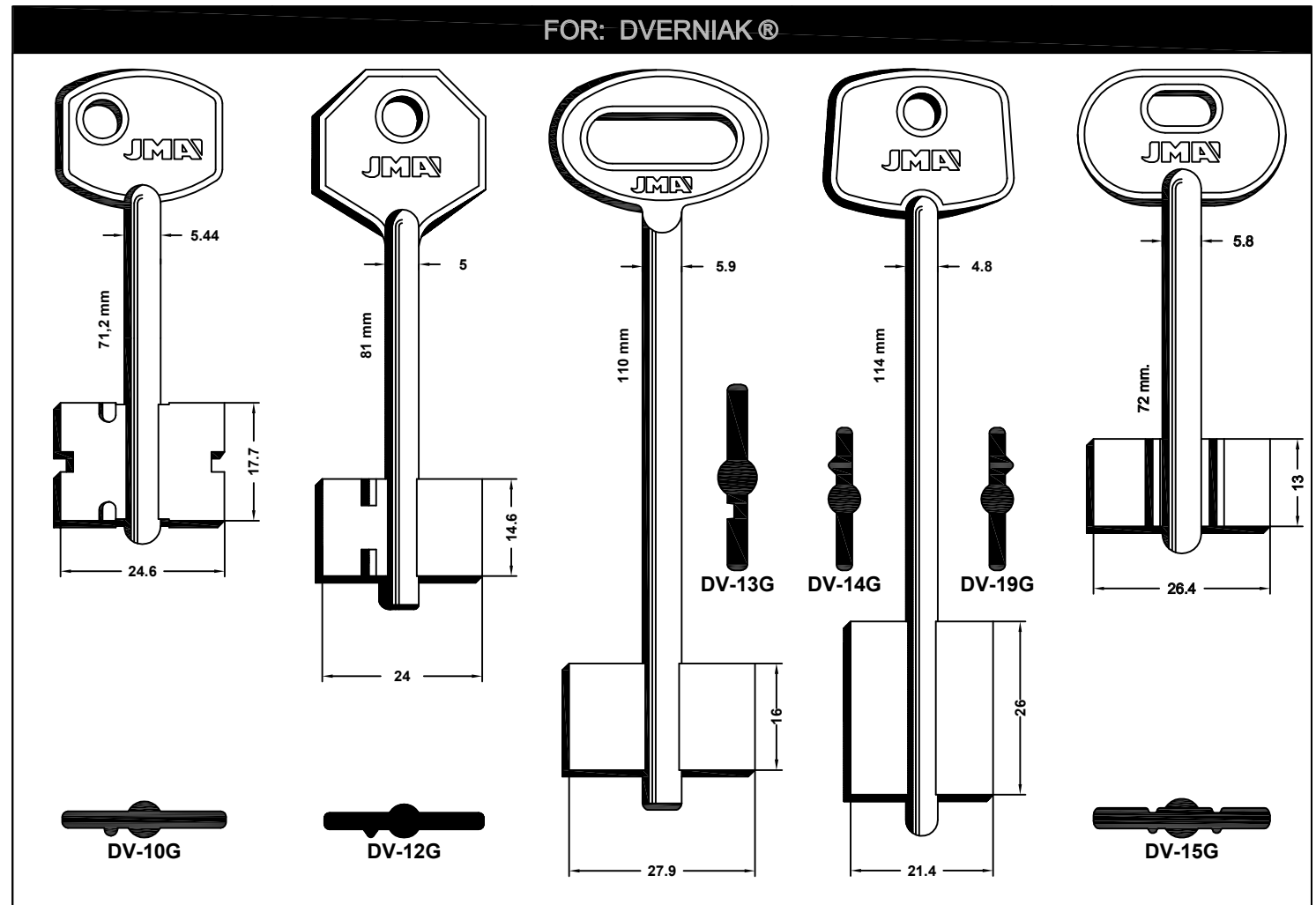
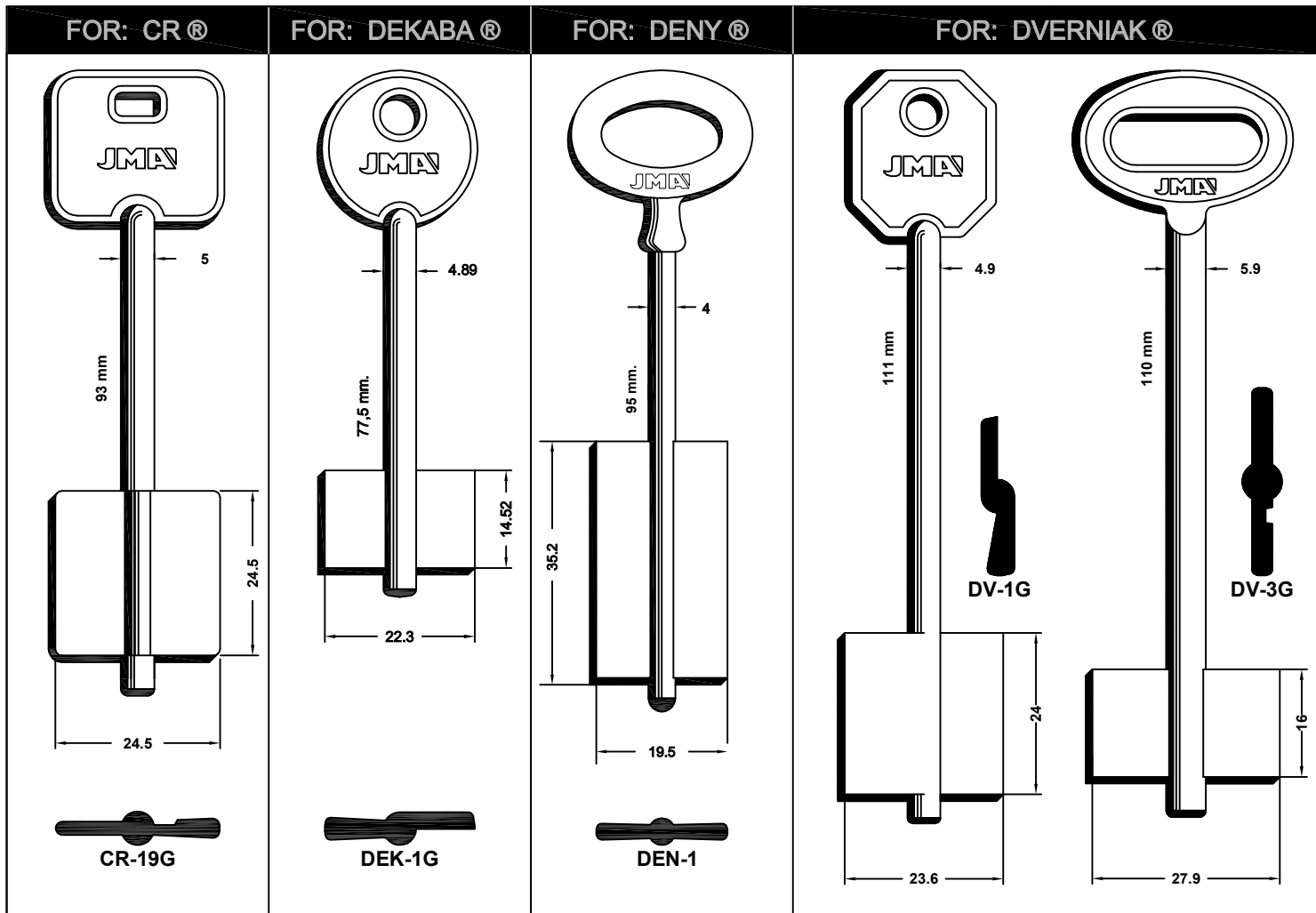

Concerning the marks and commercial denominations see legal warning.  
 Concerniente a las marcas y denominaciones comerciales ver aviso legal.  
 Marka eta izendapen komertzialiei dagokienez, ikus lege-oharra.  
 Concernant les marques et dénominations commerciales voir la note dans l'index.

**JMA** Opening the future

**JMA** Opening the future

Beziehen auf die Marke und Handelsname sehen Sie die Notiz im Index.  
 Relativamente às marcas e denominações comerciais, ver aviso legal.  
 Jeśli chodzi o znaki i nazwy handlowe, patrz Informacje prawne.



FOR: ELZETT®

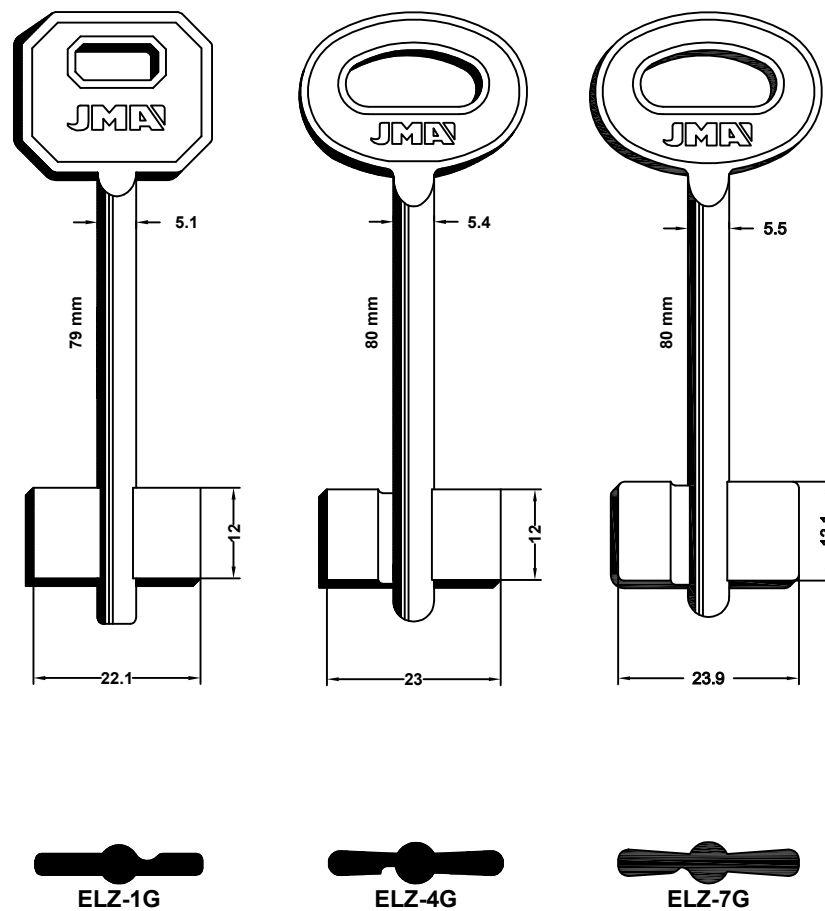

FOR: EREVAN®

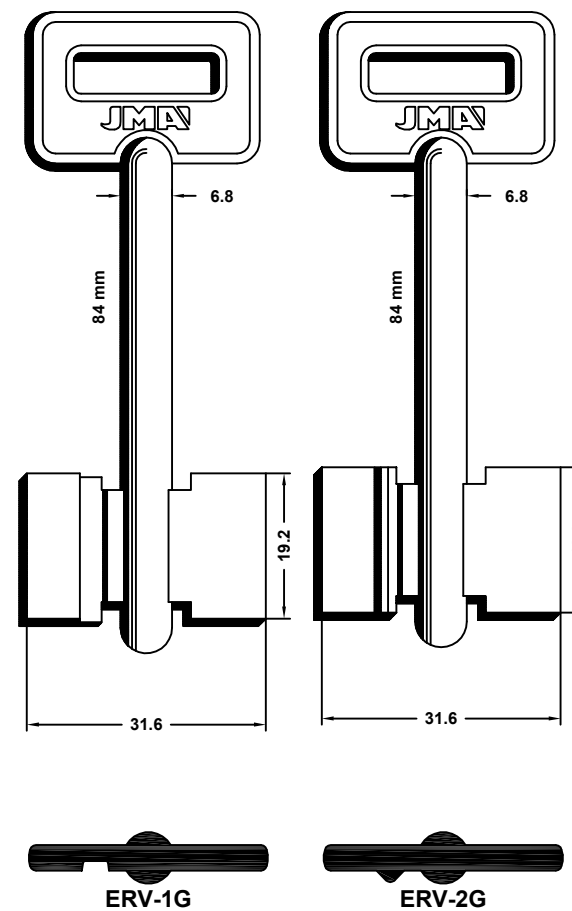

FOR: ESETY®

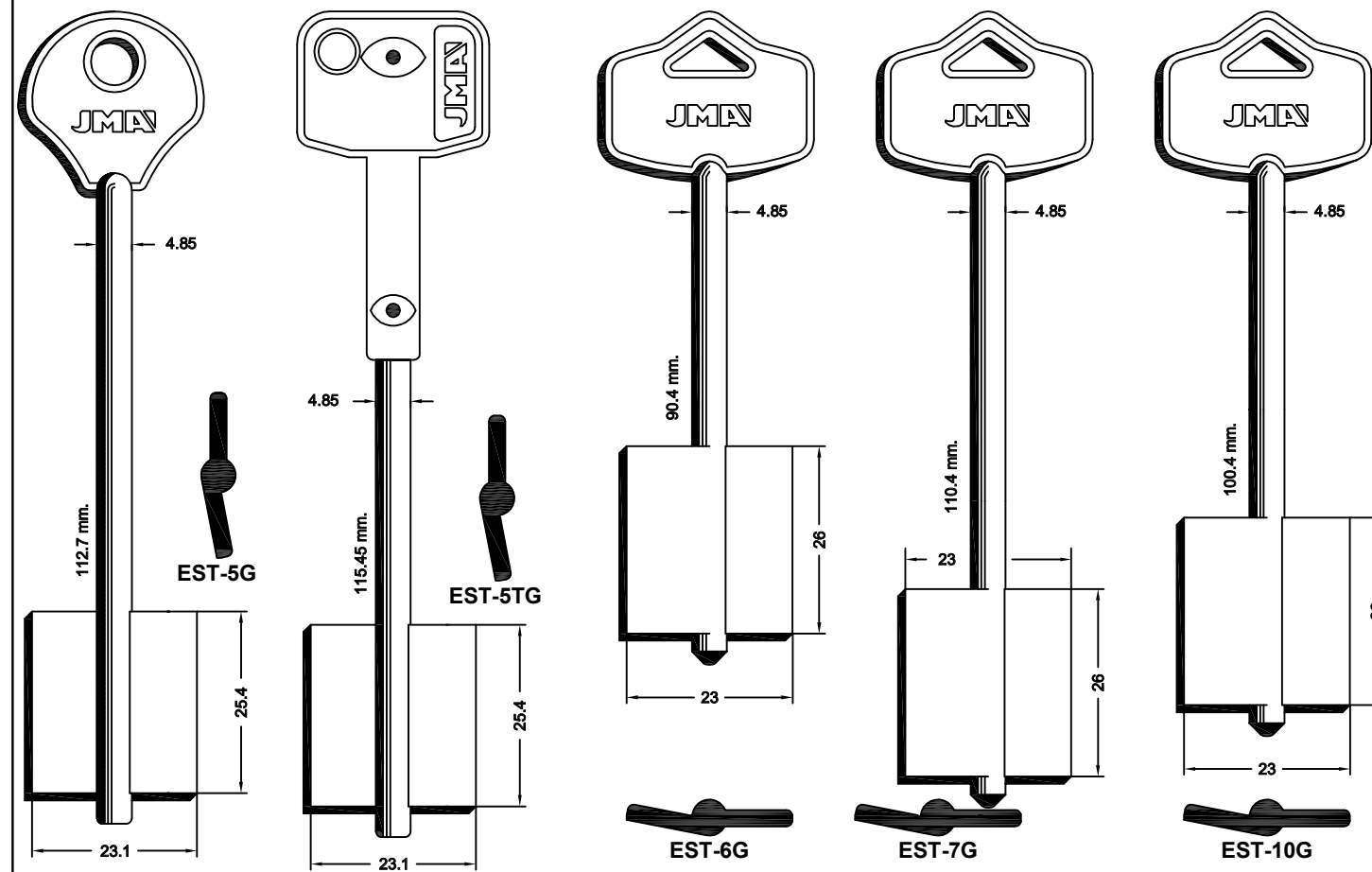

FOR: EREVAN®

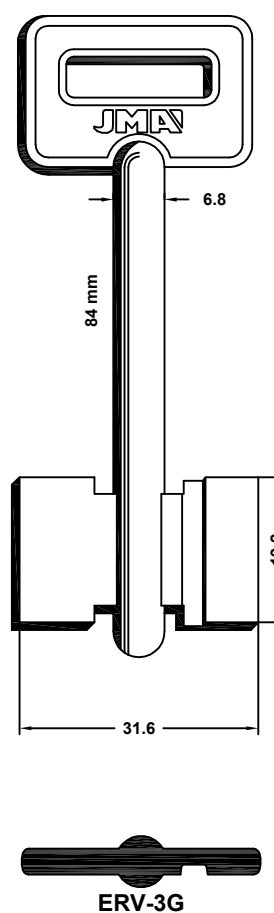

FOR: ESETY®

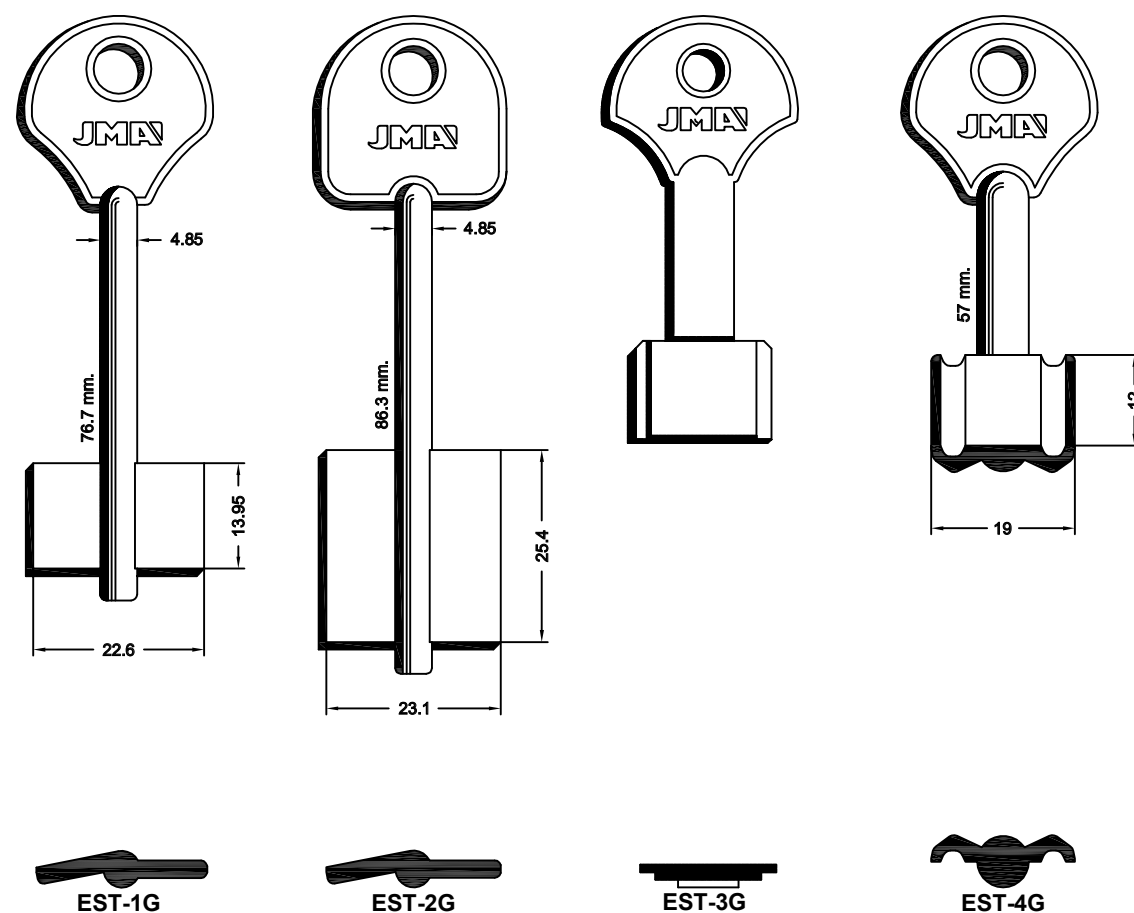

FOR: ESETY®

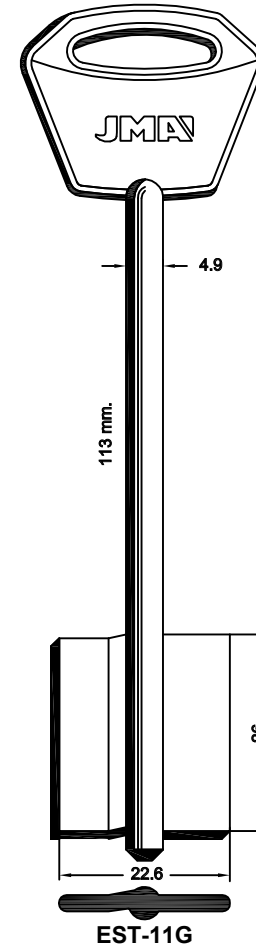

FOR: EUROTEMPLE®

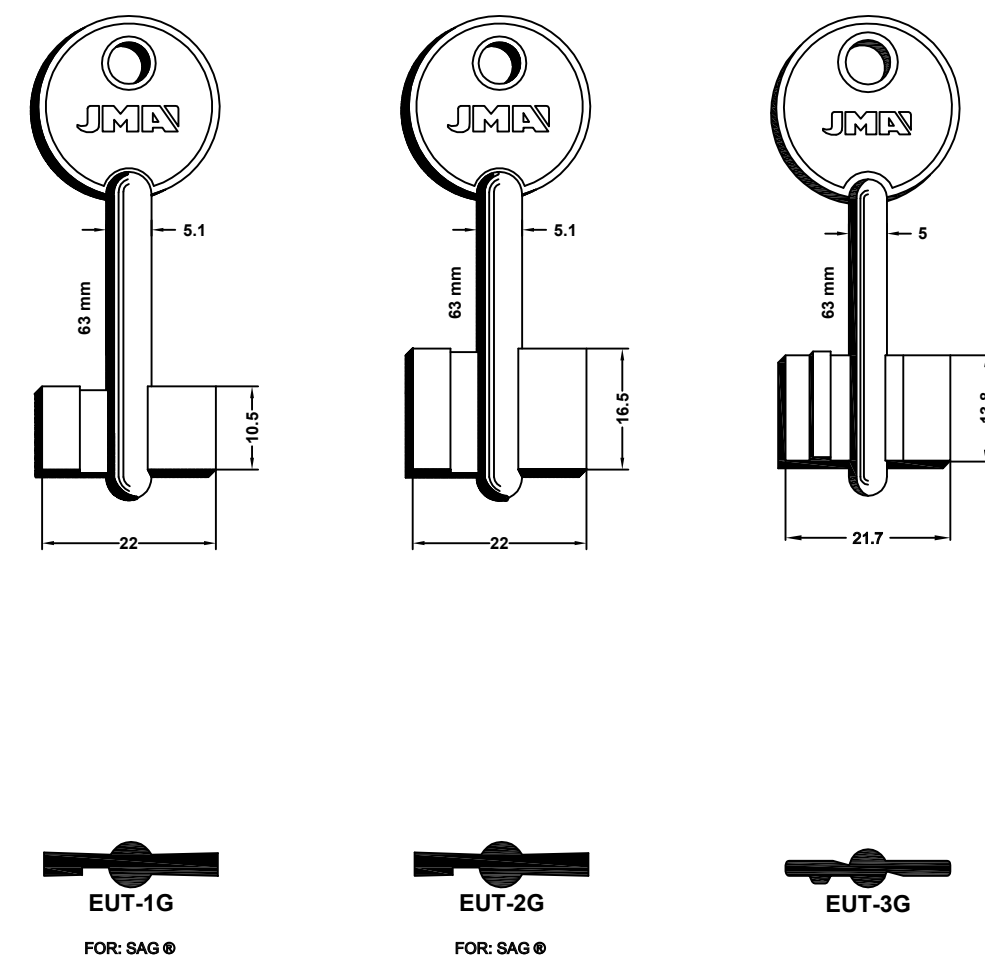

Concerning the marks and commercial denominations see legal warning.  
 Concerniente a las marcas y denominaciones comerciales ver aviso legal.  
 Marka eta izendapen komertzialiei dagokienez, ikus lege-oharra.  
 Concernant les marques et denominations commerciales voir la note dans l'index.

FOR: EZCURRA®

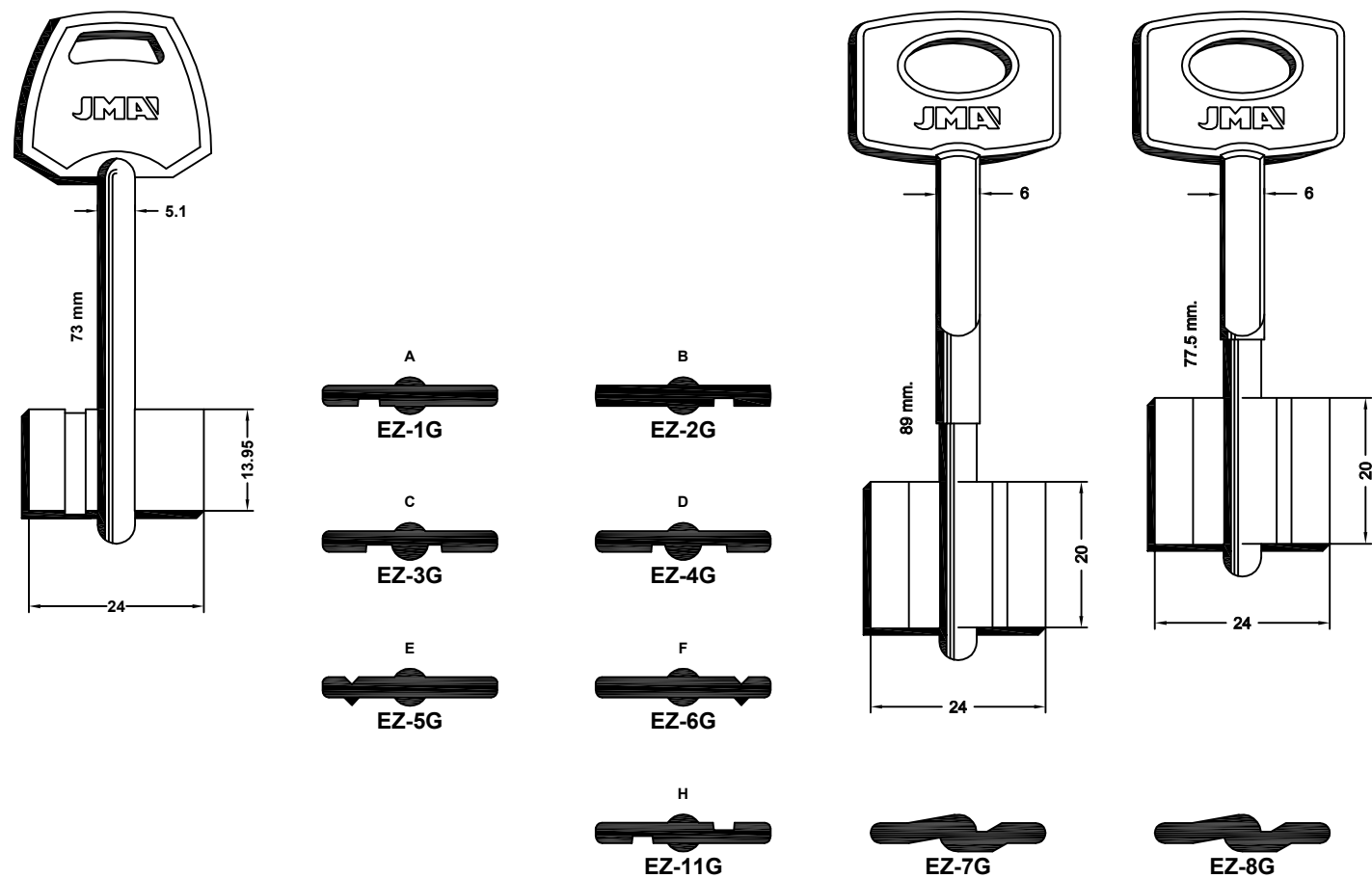

FOR: FAS®

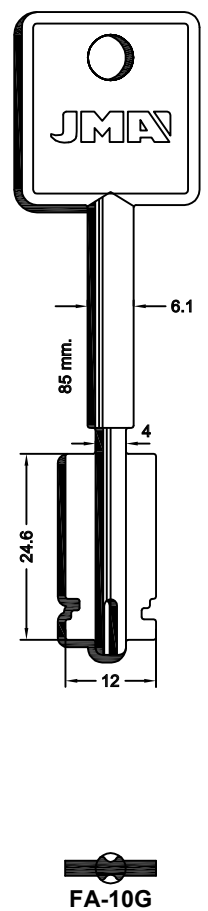

FOR: FEB®

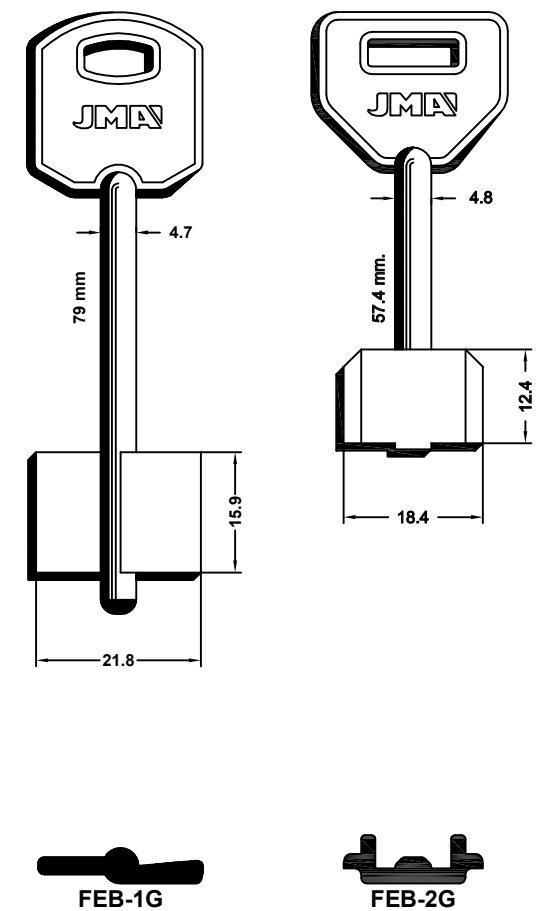

FOR: FETIS®

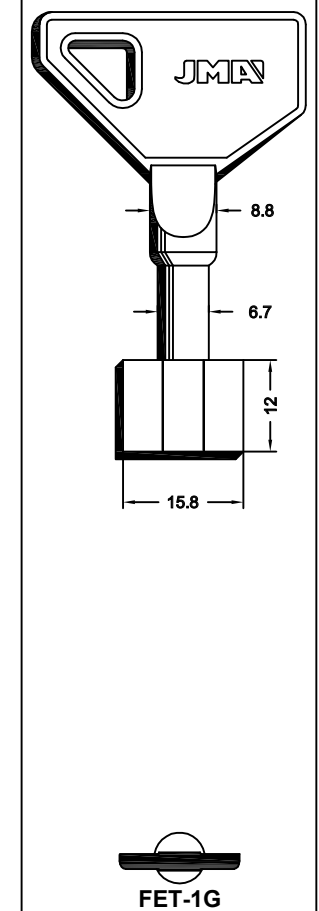

FOR: FIAM®

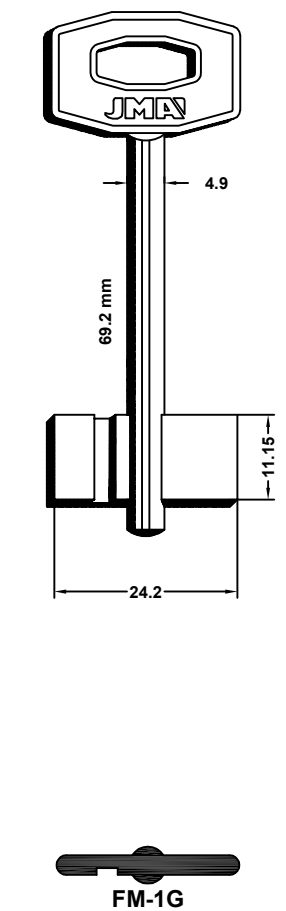

FOR: FAC®

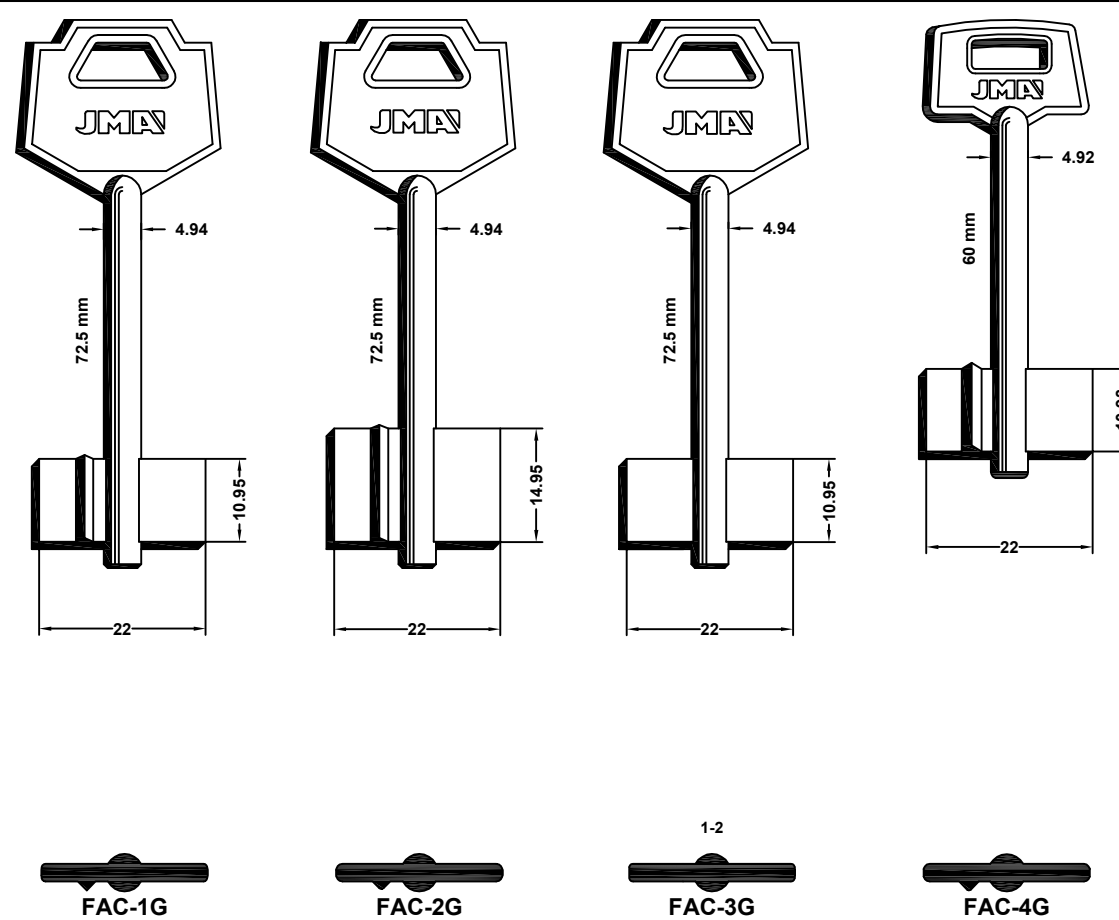

FOR: FAS®

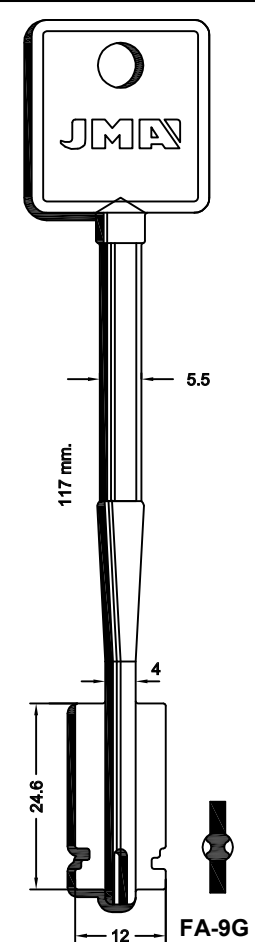

FOR: FIAM®

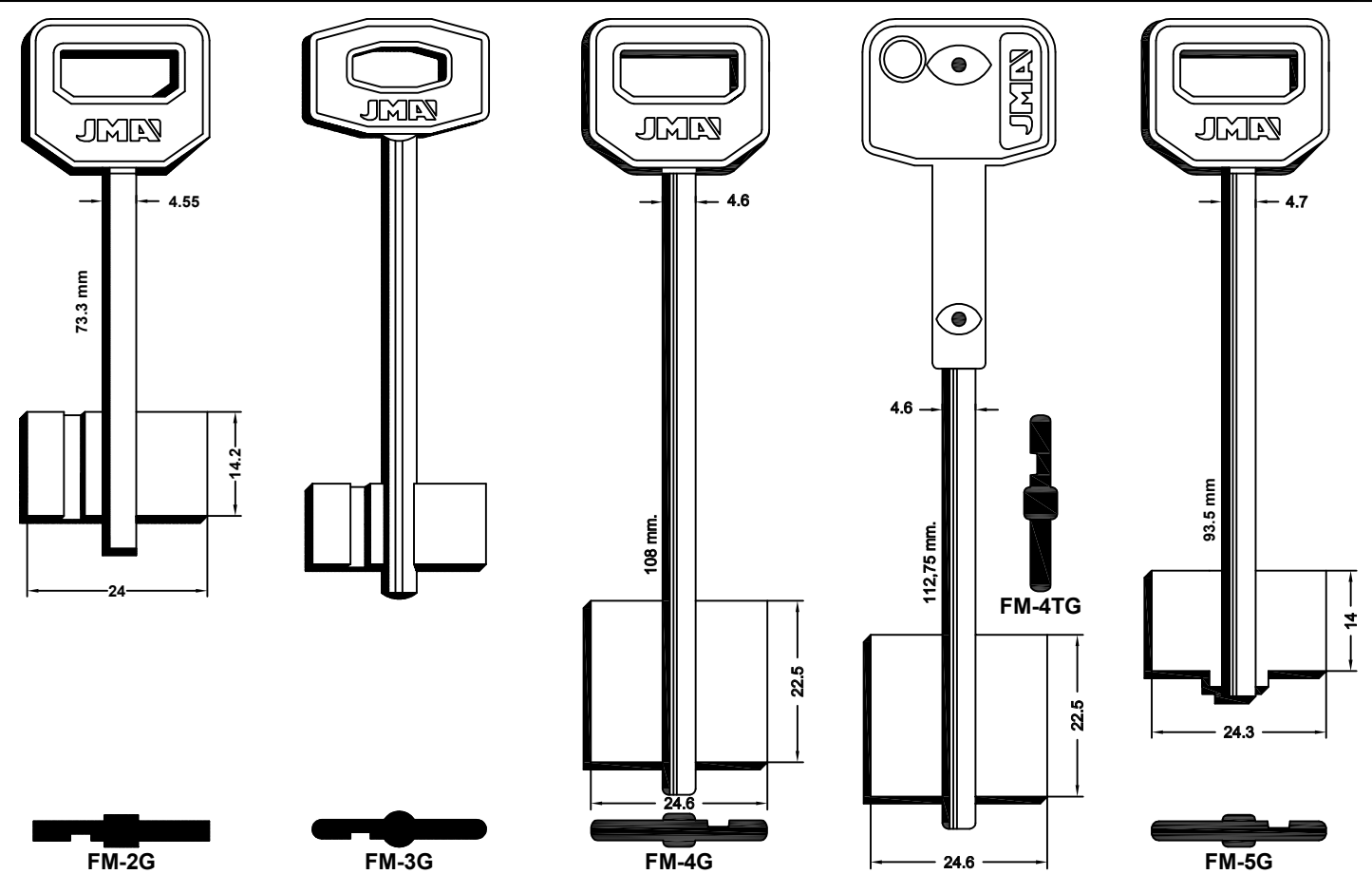

Concerning the marks and commercial denominations see legal warning.  
 Concerniente a las marcas y denominaciones comerciales ver aviso legal.  
 Marka eta izendapen komertzialiei dagokienez, ikus lege-oharra.  
 Concernant les marques et dénominations commerciales voir la note dans l'index.

FOR: FIAM®

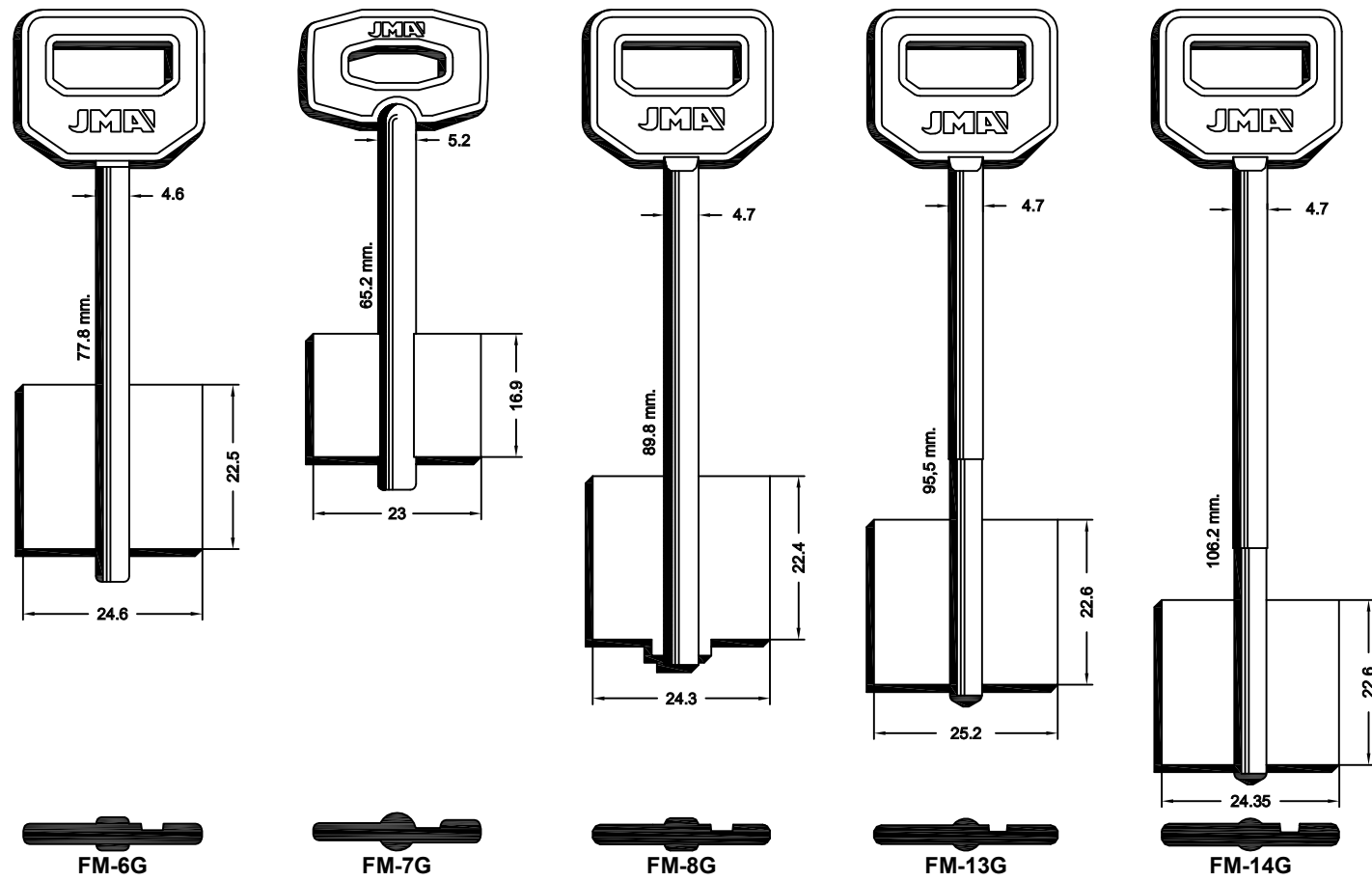

FOR: GARDIAN®

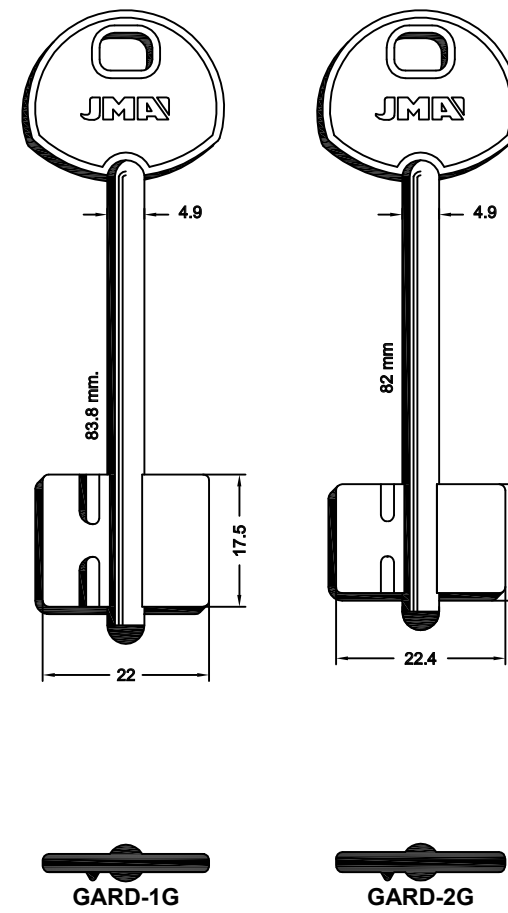

FOR: GERION®

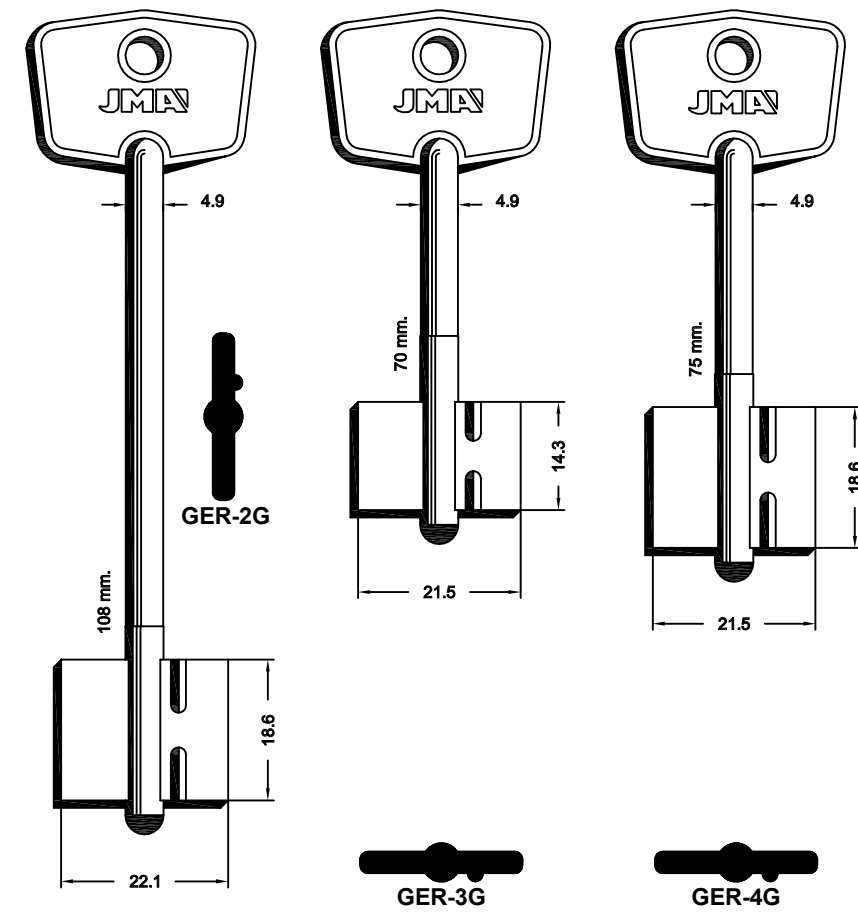

FOR: FIAM®

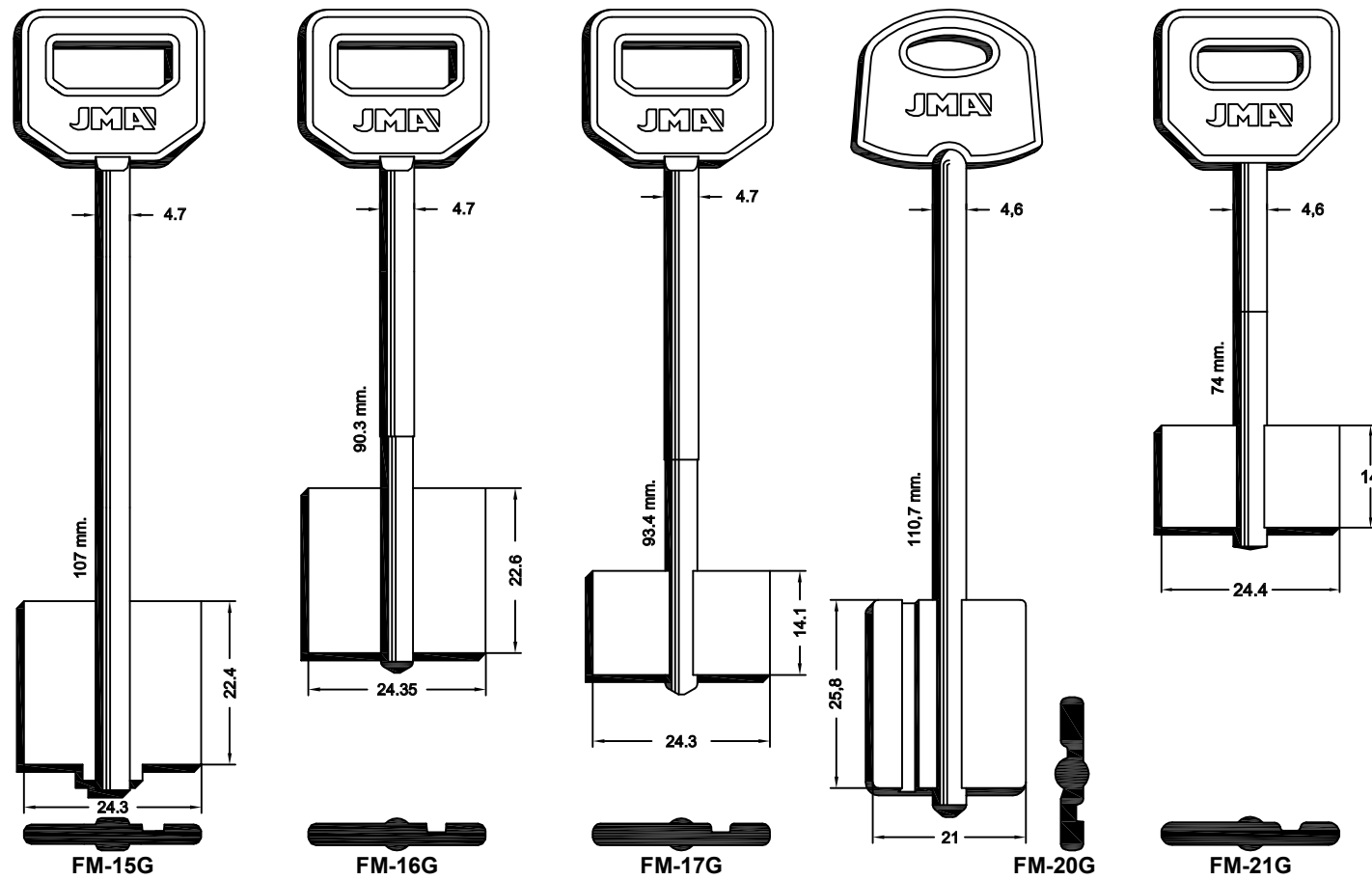

FOR: ISEO®

FOR: GERION®

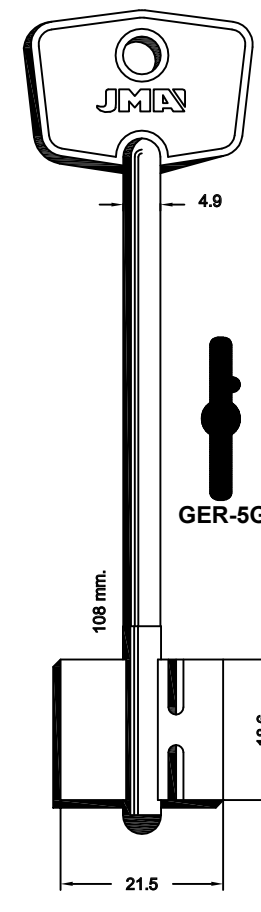

FOR: GIMAST®

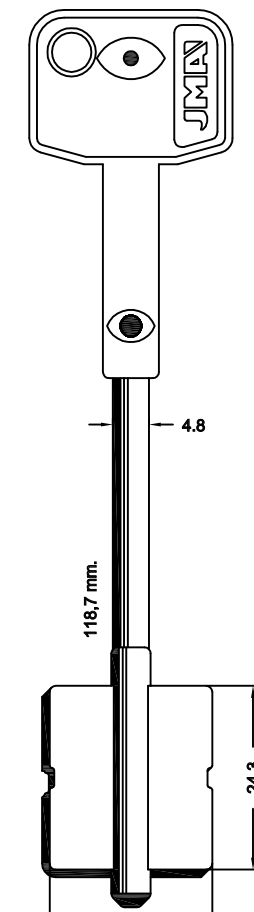

FOR: GIPIS®

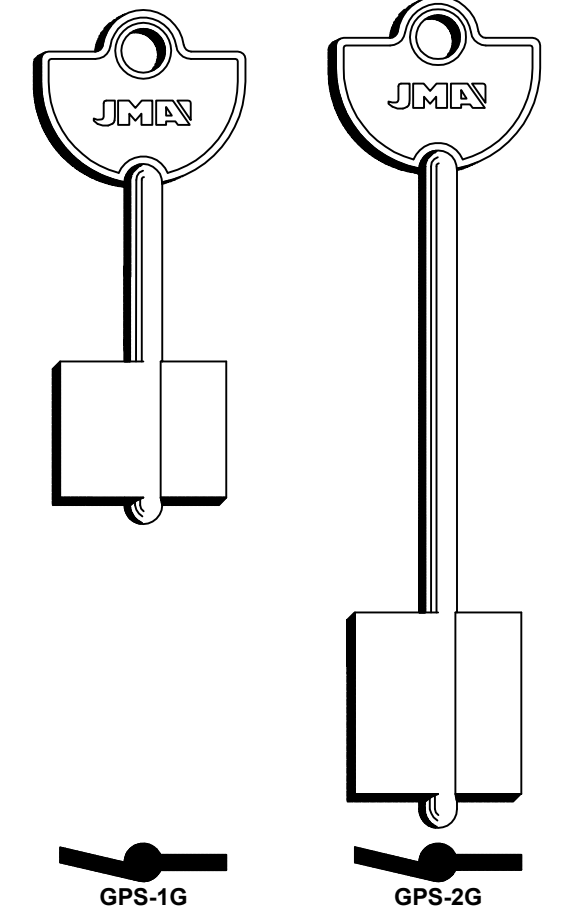

Concerning the marks and commercial denominations see legal warning.  
 Concerniente a las marcas y denominaciones comerciales ver aviso legal.  
 Marka eta izendapen komertzialiei dagokienez, ikus lege-oharra.  
 Concernant les marques et denominations commerciales voir la note dans l'index.



FOR: GMG®

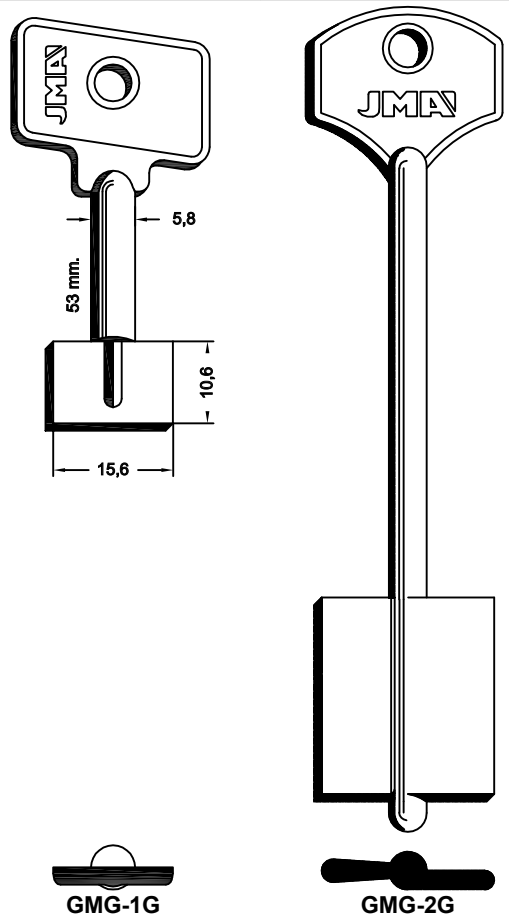

GMG-1G

GMG-2G

FOR: IDM®

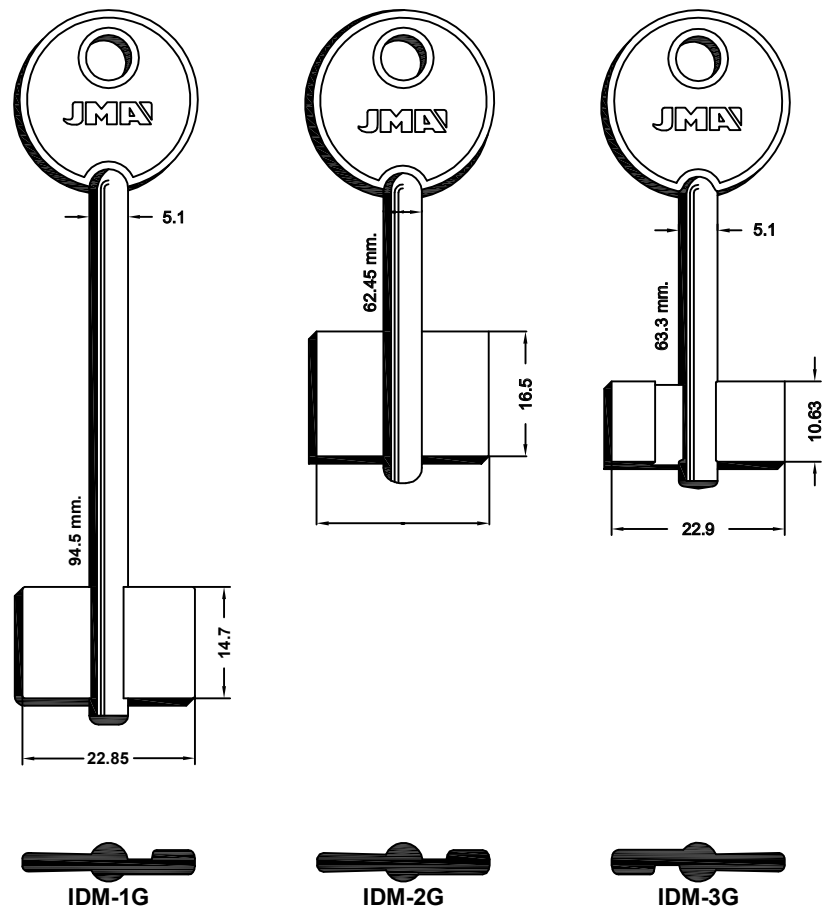

IDM-1G

IDM-2G

IDM-3G

FOR: SAG®

FOR: SAG®

FOR: ISEO®

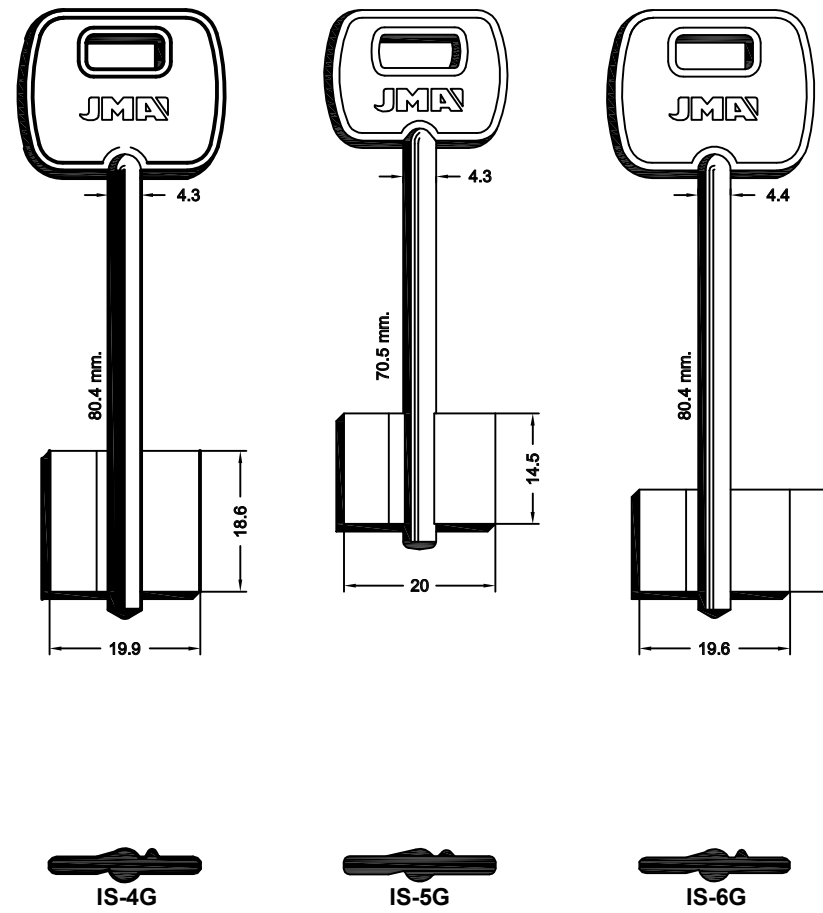

IS-4G

IS-5G

IS-6G

FOR: ITAL®

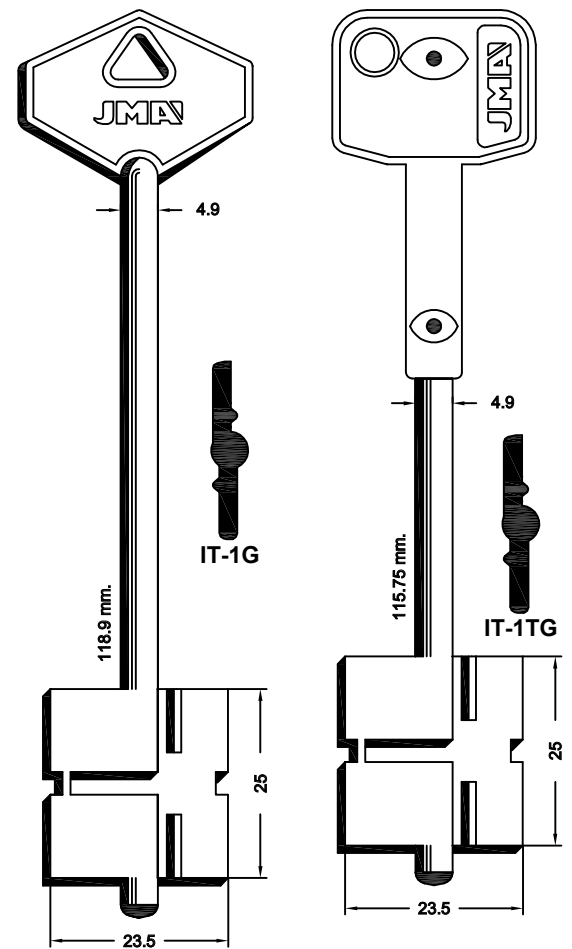

IT-1G

IT-1TG

FOR: IDM®

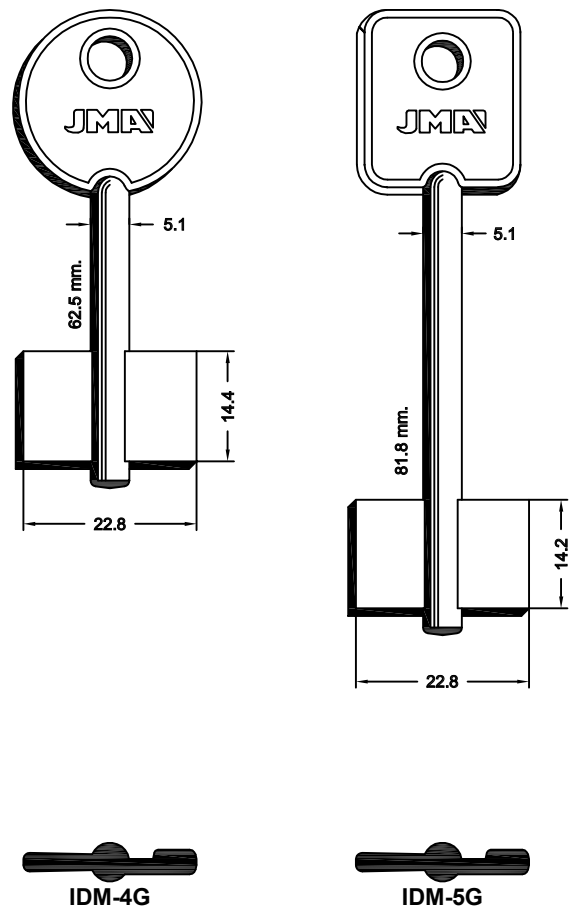

IDM-4G

IDM-5G

FOR: FACEF® -DOMUS®

FOR: ISEO®

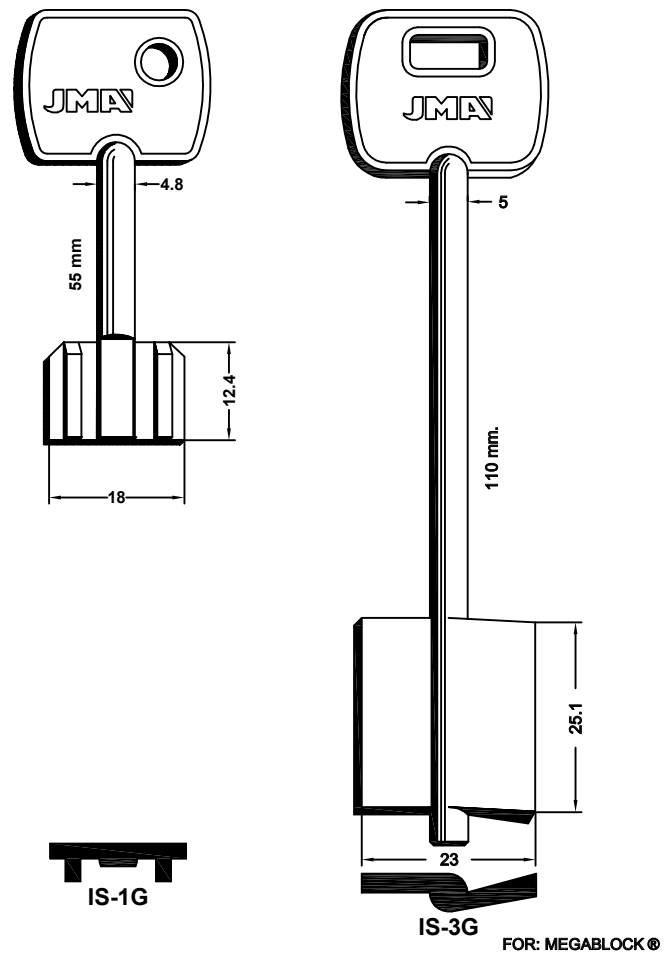

IS-1G

IS-3G

FOR: MEGABLOCK®

FOR: ITAL®

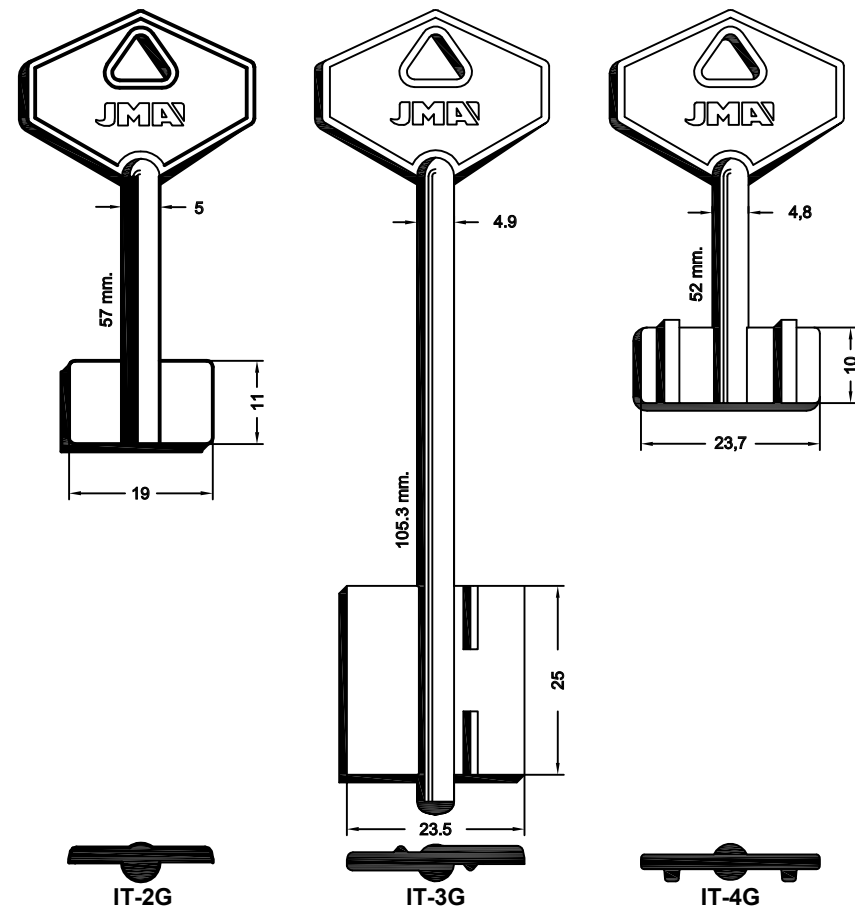

IT-2G

IT-3G

IT-4G

FOR: JUWEL®

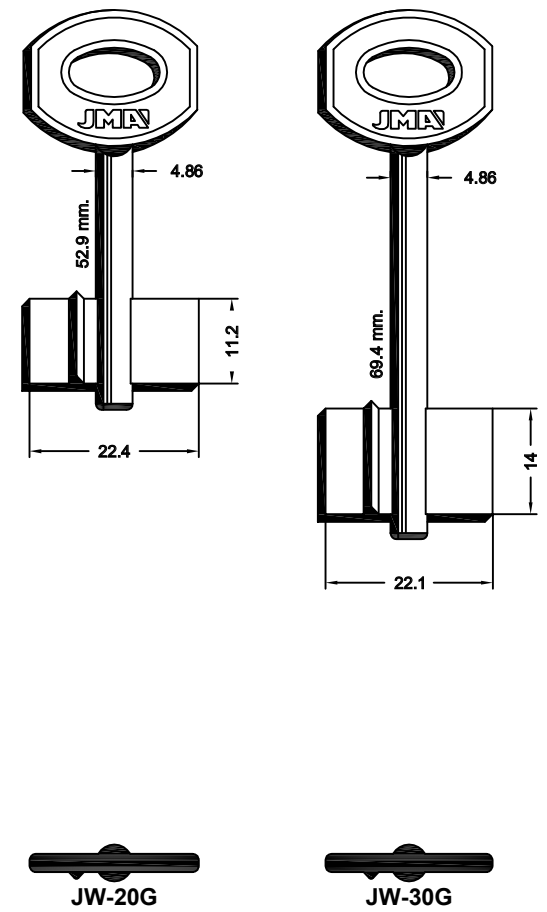

JW-20G

JW-30G

FOR: BURG-WACHTER®

FOR: BURG-WACHTER®

Concerning the marks and commercial denominations see legal warning.  
 Concerniente a las marcas y denominaciones comerciales ver aviso legal.  
 Marka eta izendapen komertzialiei dagokienez, ikus lege-oharra.  
 Concernant les marques et dénominations commerciales voir la note dans l'index.

**JMA** Opening the future

**JMA** Opening the future

Beziehen auf die Marke und Handelsname sehen Sie die Notiz im Index.  
 Relativamente às marcas e denominações comerciais, ver aviso legal.  
 Jeśli chodzi o znaki i nazwy handlowe, patrz Informacje prawne.

FOR: JUWEL®

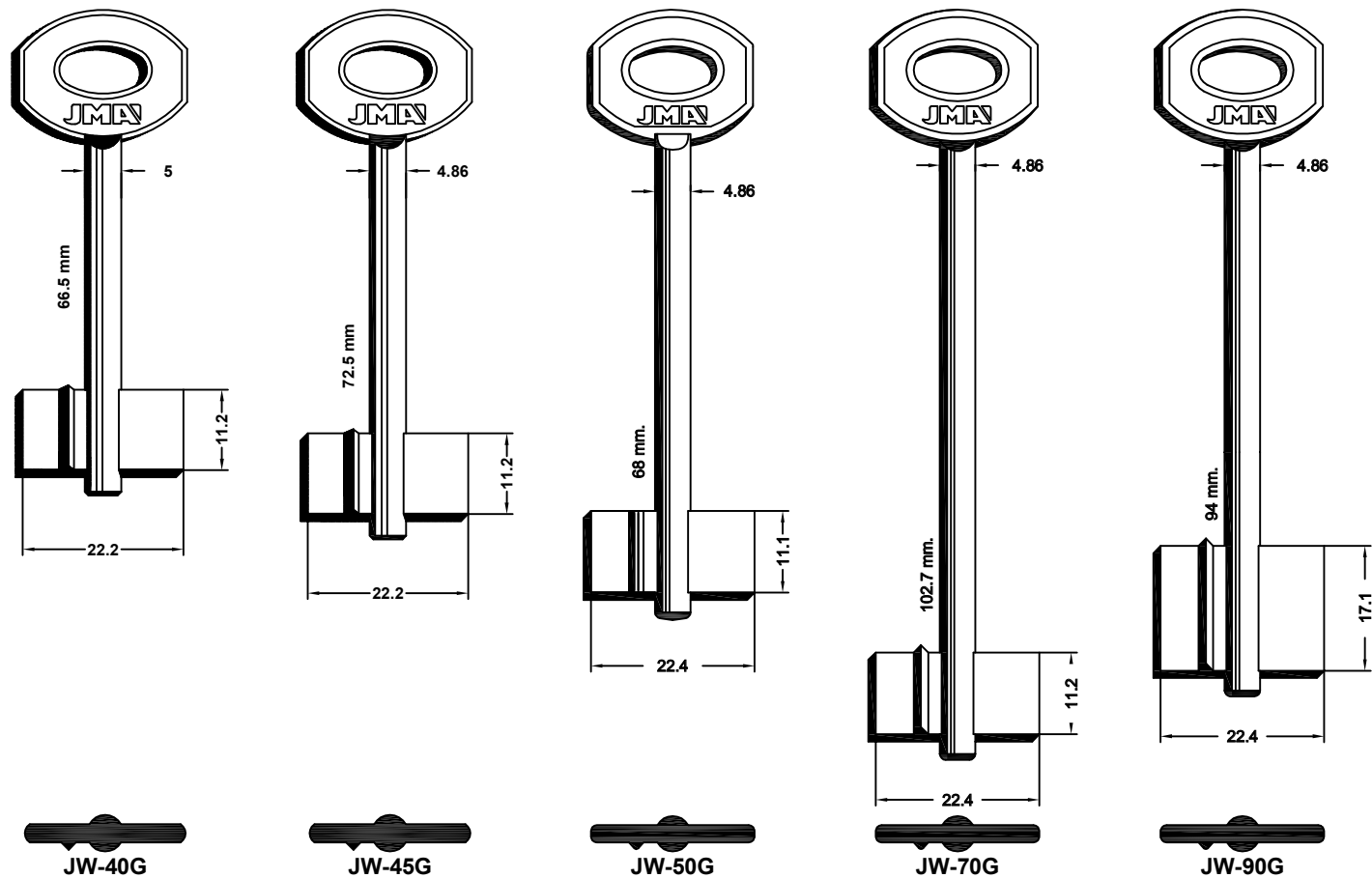

FOR: BURG-WACHTER®

FOR: BURG-WACHTER®

FOR: BURG-WACHTER®

FOR: KERBEROS®

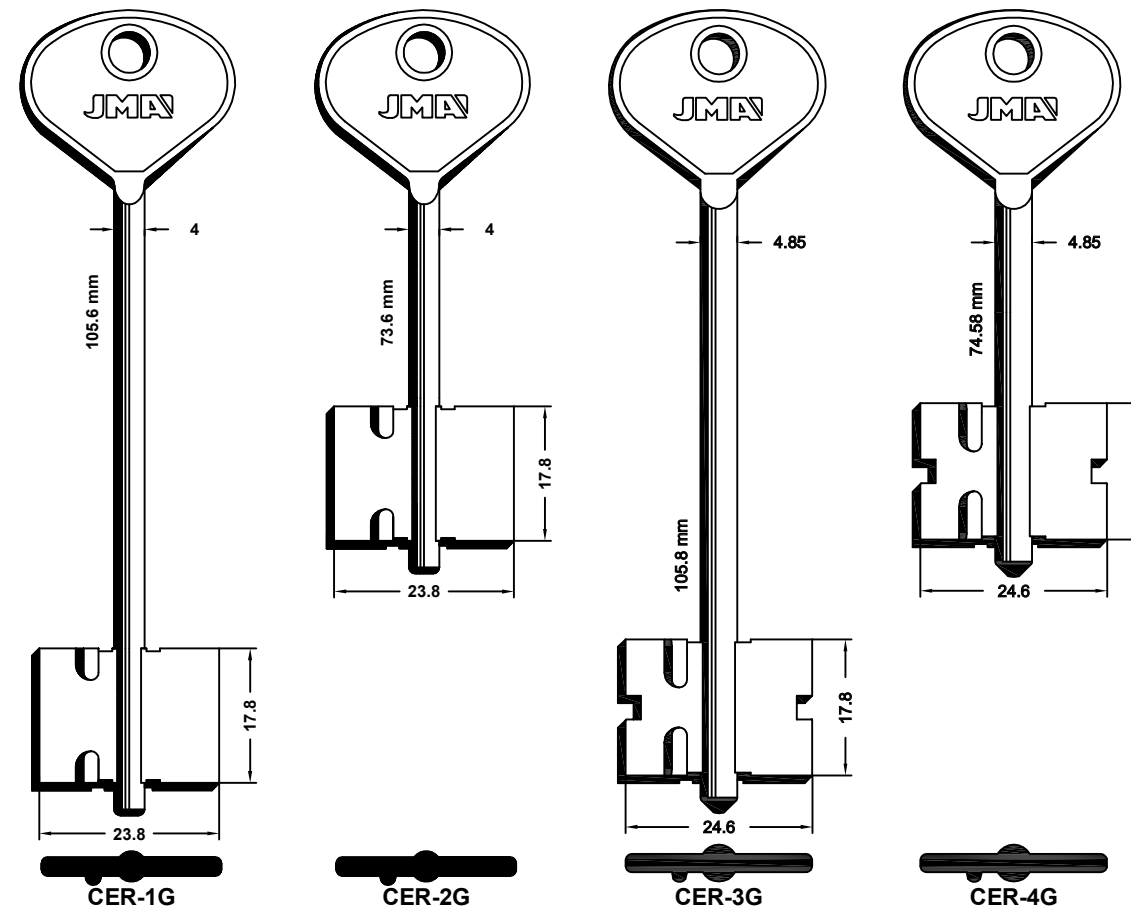

CER-1G

CER-2G

CER-3G

CER-4G

FOR: KREPISH®

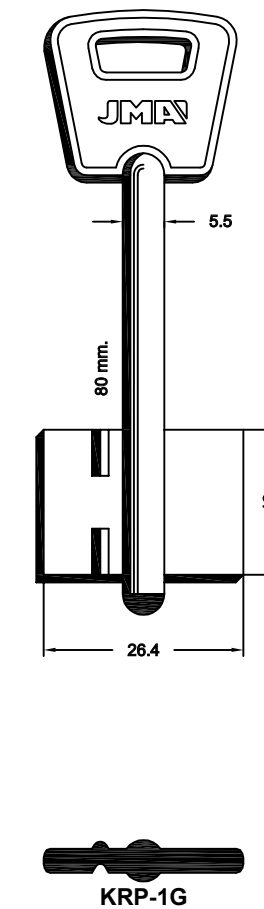

KRP-1G

FOR: KALE®

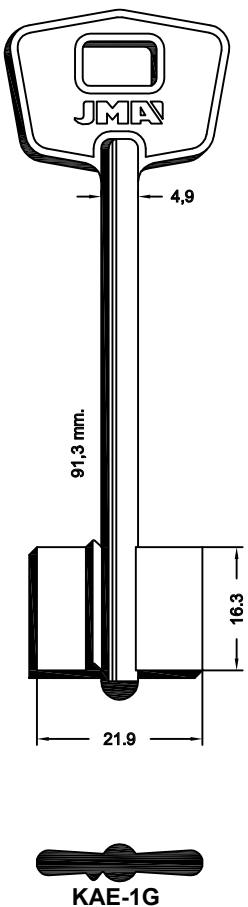

KAE-1G

FOR: KASSEL®

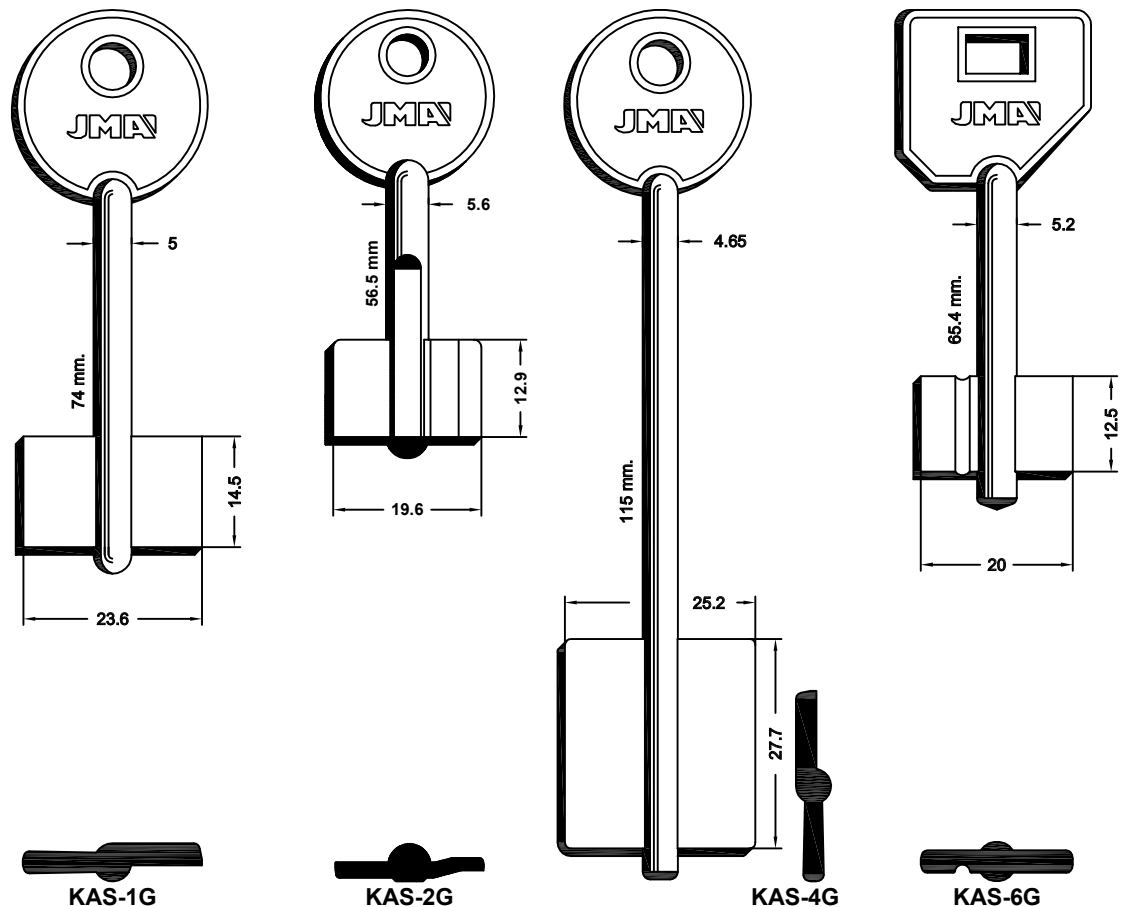

KAS-1G

KAS-2G

KAS-4G

KAS-6G

FOR: KURZEME®

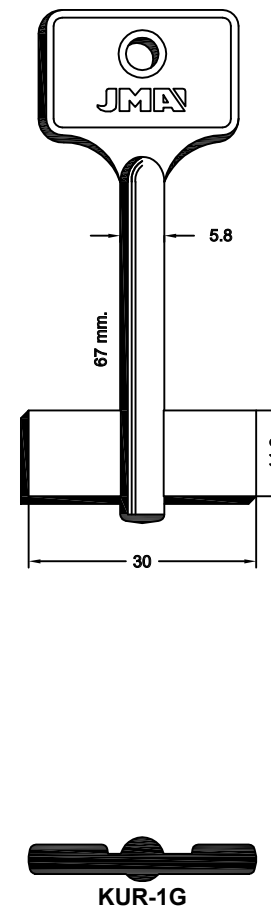

KUR-1G

FOR: LINCE®

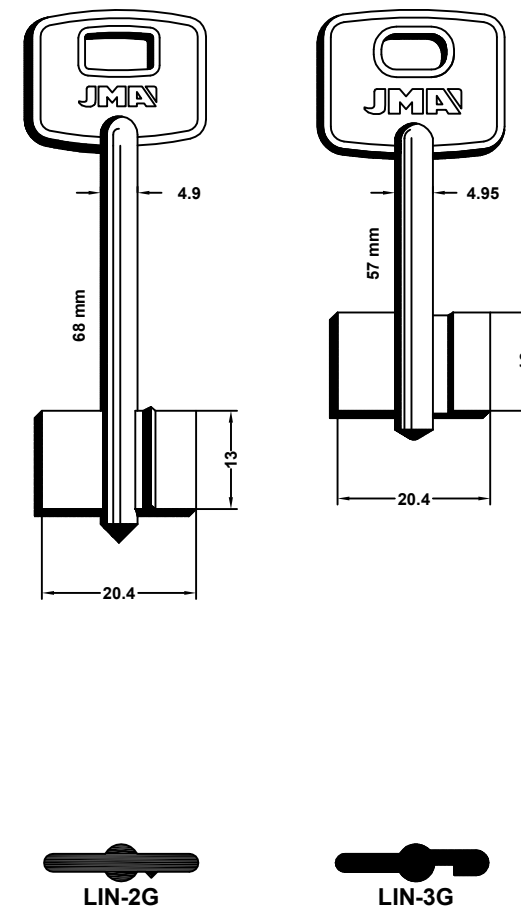

LIN-2G

LIN-3G

FOR: MCM®

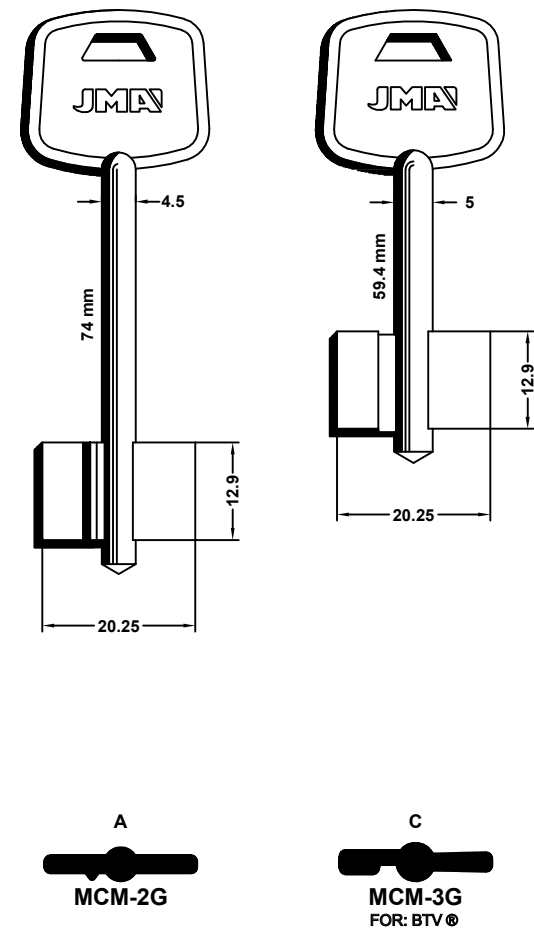

MCM-2G

MCM-3G

FOR: BTV®

Concerning the marks and commercial denominations see legal warning.  
 Concerniente a las marcas y denominaciones comerciales ver aviso legal.  
 Marka eta izendapen komertzialiei dagokienez, ikus lege-oharra.  
 Concernant les marques et denominations commerciales voir la note dans l'index.

**JMA** Opening the future

**JMA** Opening the future

Beziehen auf die Marke und Handelsname sehen Sie die Notiz im Index.  
 Relativamente às marcas e denominações comerciais, ver aviso legal.  
 Jeśli chodzi o znaki i nazwy handlowe, patrz Informacje prawne.

**FOR: MCM®**

**FOR: METAL®**

**FOR: MOIA®**

**MCM-5G**  
FOR: BTV®

**MTL-1G**

**MTL-2G**

**MOI-1G**

**MOI-2G**

**FOR: MOTTURA®**

**MT-2TG**

**MT-3G**

**MT-3P1G**

**MT-3PG**

**MT-4G**

**FOR: MOIA®**

**FOR: MOTTURA®**

**MOI-3G**

**MOI-4G**

**MOI-5G**

**FOR: O.M.R.®**

**O.M.R.**

**MT-1G**

**MT-2G**

**FOR: MOTTURA®**

**MT-5G**

**MT-5P1G**

**MT-6G**

**MT-6P1G**

Concerning the marks and commercial denominations see legal warning.  
 Concerniente a las marcas y denominaciones comerciales ver aviso legal.  
 Marka eta izendapen komertzialiei dagokienez, ikus lege-oharra.  
 Concernant les marques et denominations commerciales voir la note dans l'index.

**JMA®** Opening the future

**JMA®** Opening the future

Beziehen auf die Marke und Handelsname sehen Sie die Notiz im Index.  
 Relativamente às marcas e denominações comerciais, ver aviso legal.  
 Jeśli chodzi o znaki i nazwy handlowe, patrz Informacje prawne.

FOR: MOTTURA®

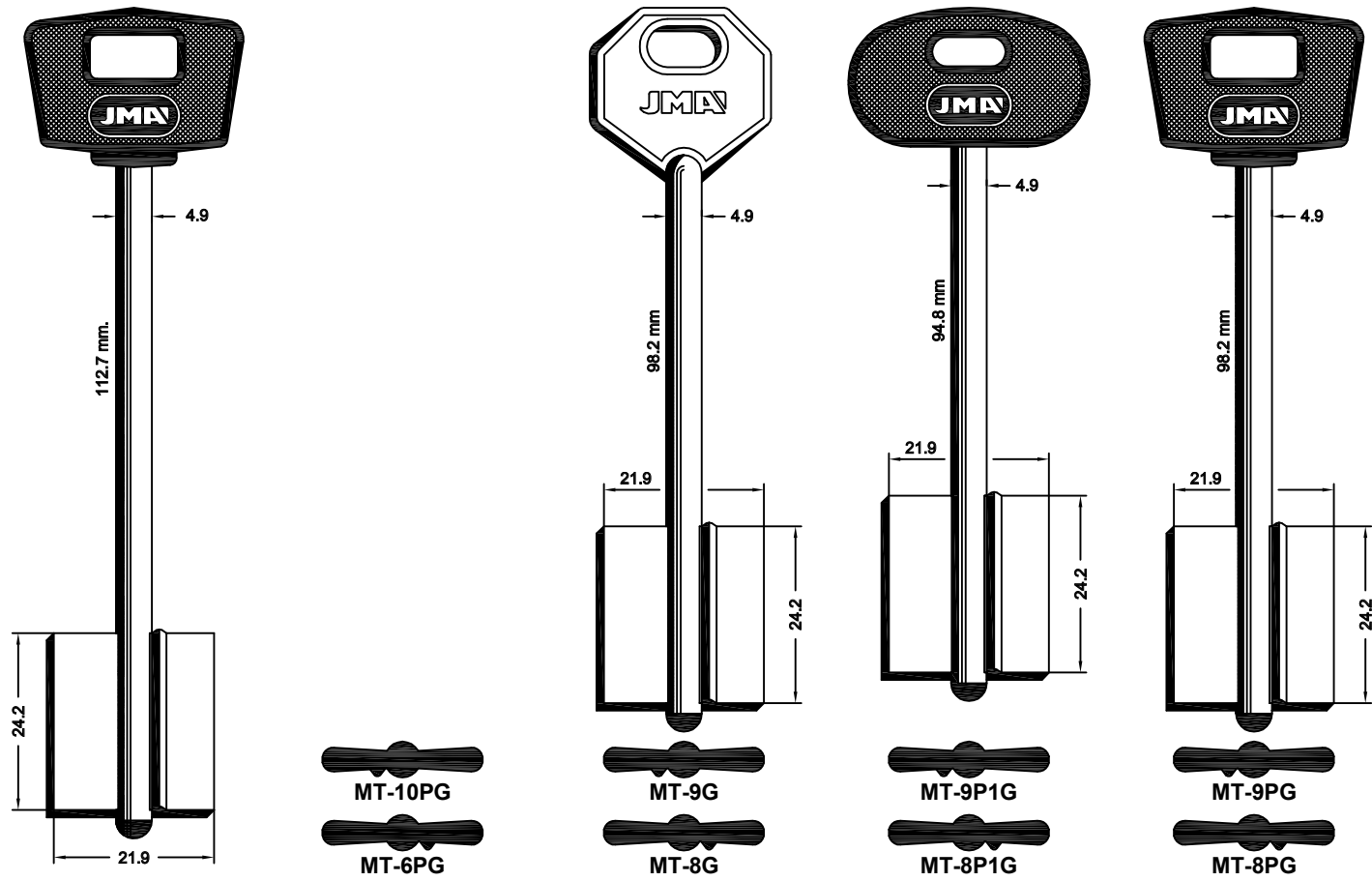

FOR: MOTTURA®

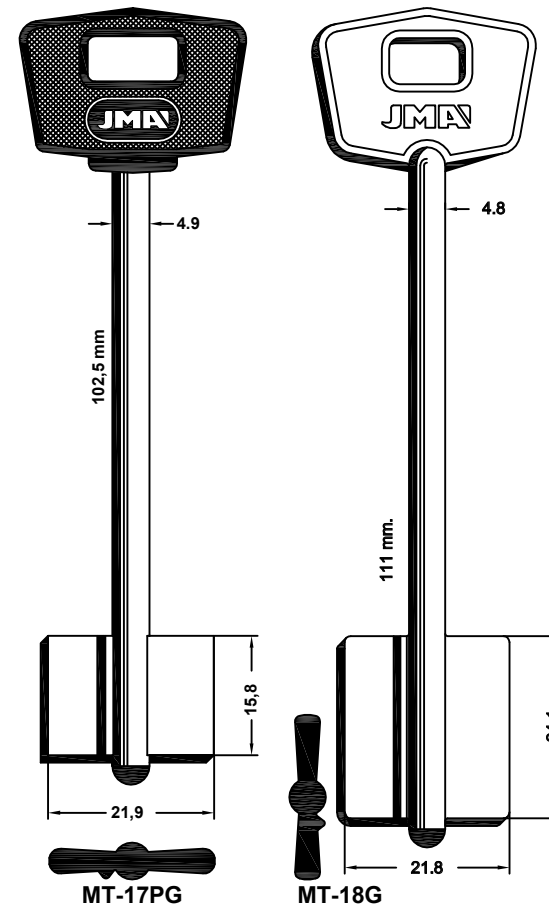

FOR: OMEC®

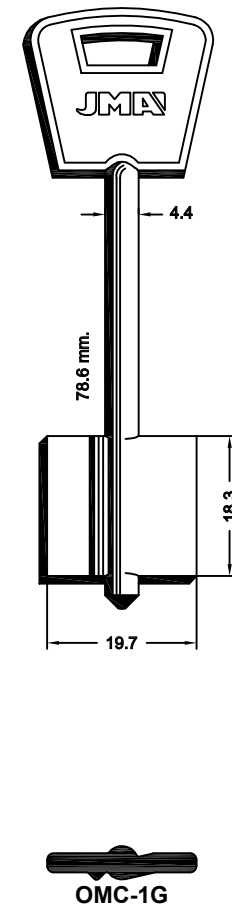

FOR: ORENGO®

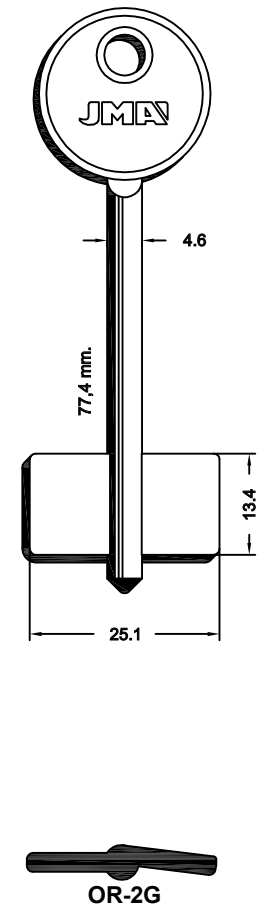

FOR: PATRONE®

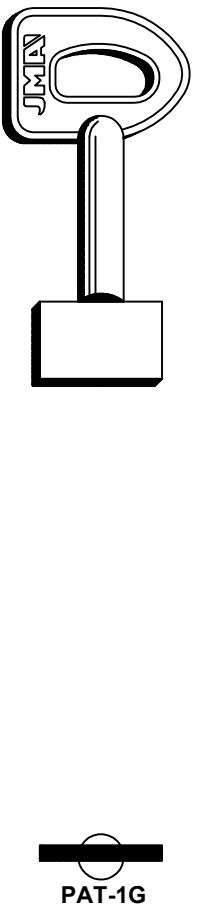

FOR: MOTTURA®

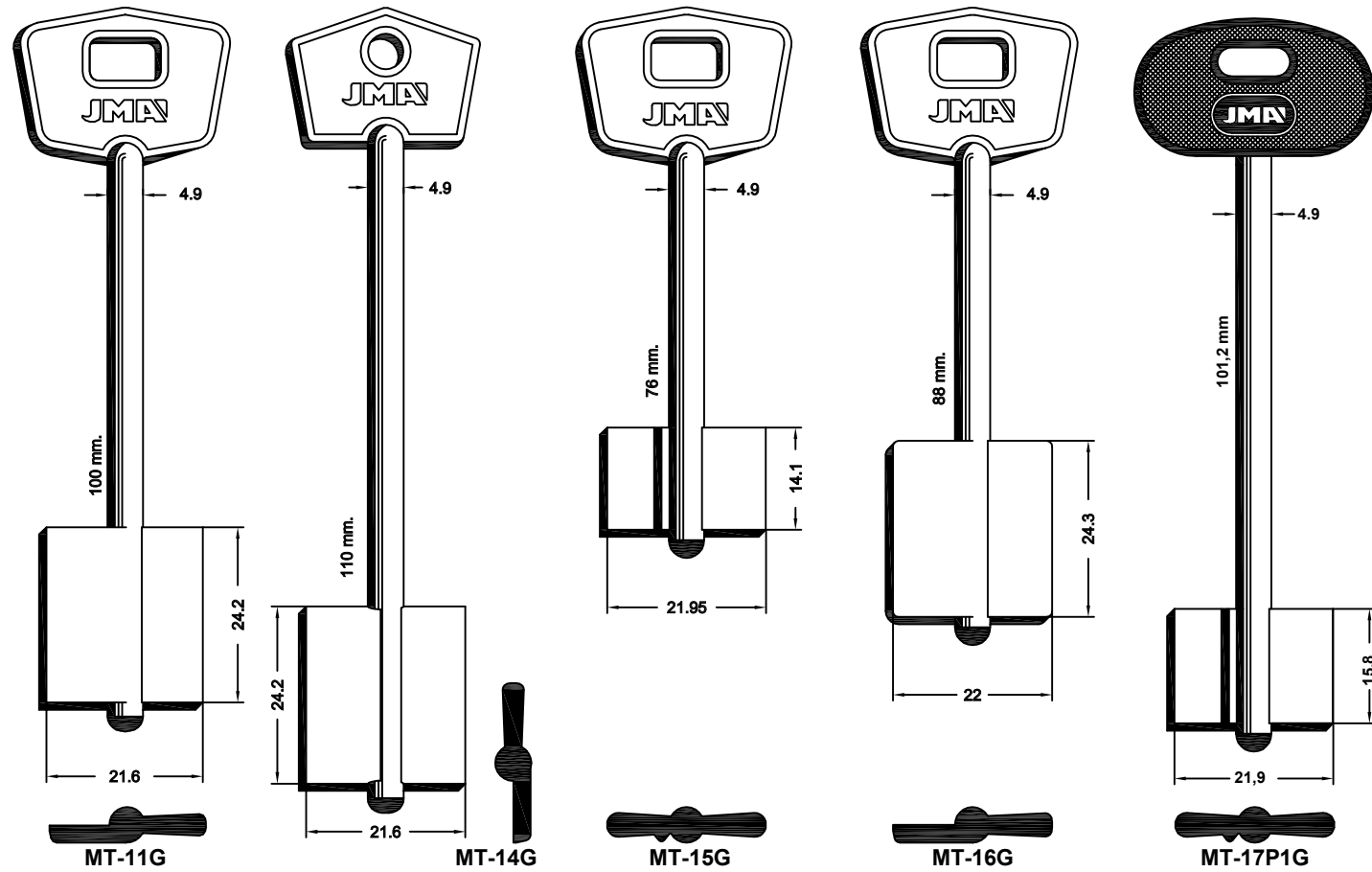

FOR: POTENT®

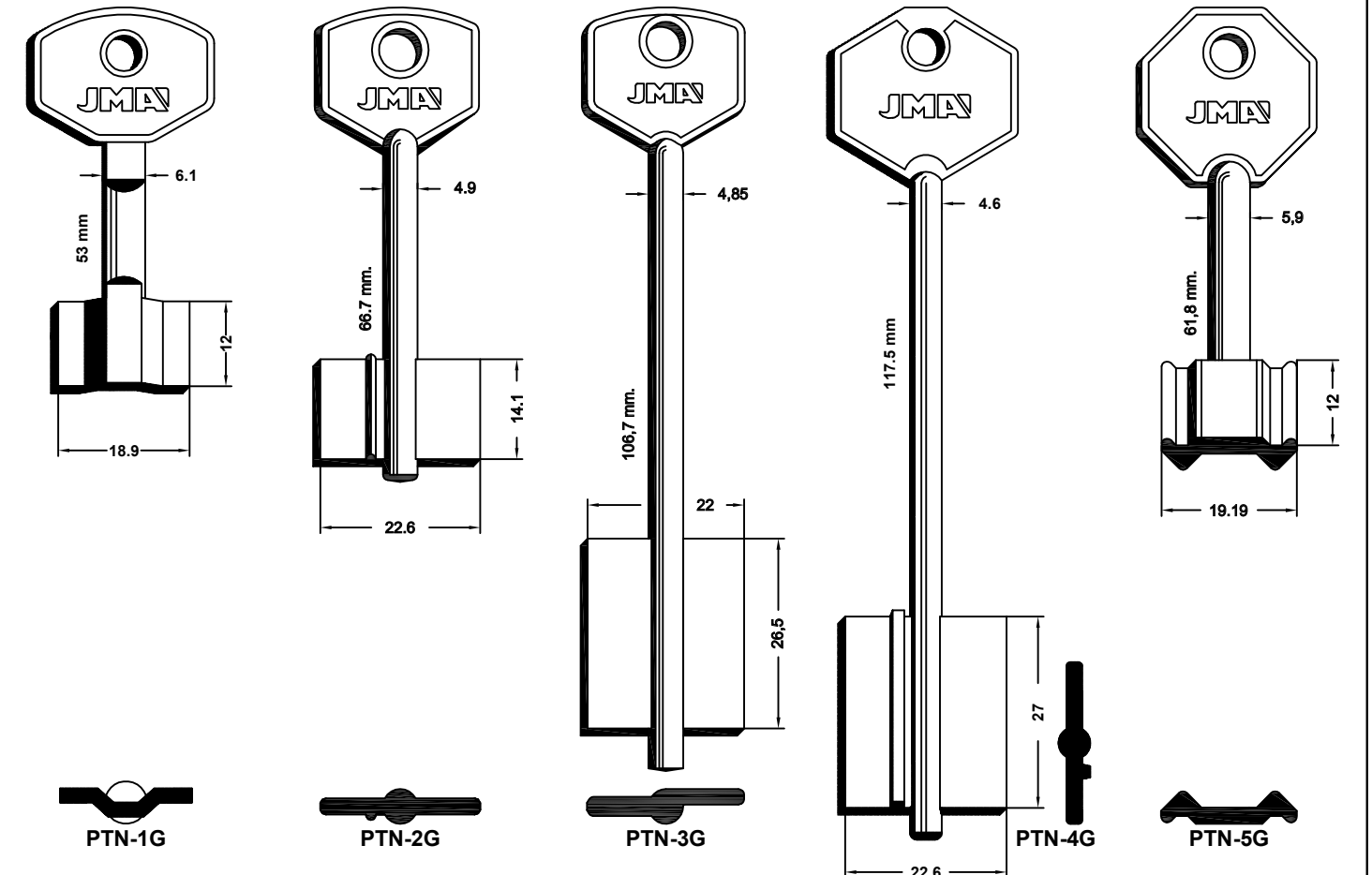

Concerning the marks and commercial denominations see legal warning.  
 Concerniente a las marcas y denominaciones comerciales ver aviso legal.  
 Marka eta izendapen komertzialiei dagokienez, ikus lege-oharra.  
 Concernant les marques et denominations commerciales voir la note dans l'index.

**JMA** Opening the future

**JMA** Opening the future

Beziehen auf die marke und handelsname sehen sie die notiz im index.  
 Relativamente às marcas e denominações comerciais, ver aviso legal.  
 Jeśli chodzi o znaki i nazwy handlowe, patrz Informacje prawne.



FOR: POTENT®

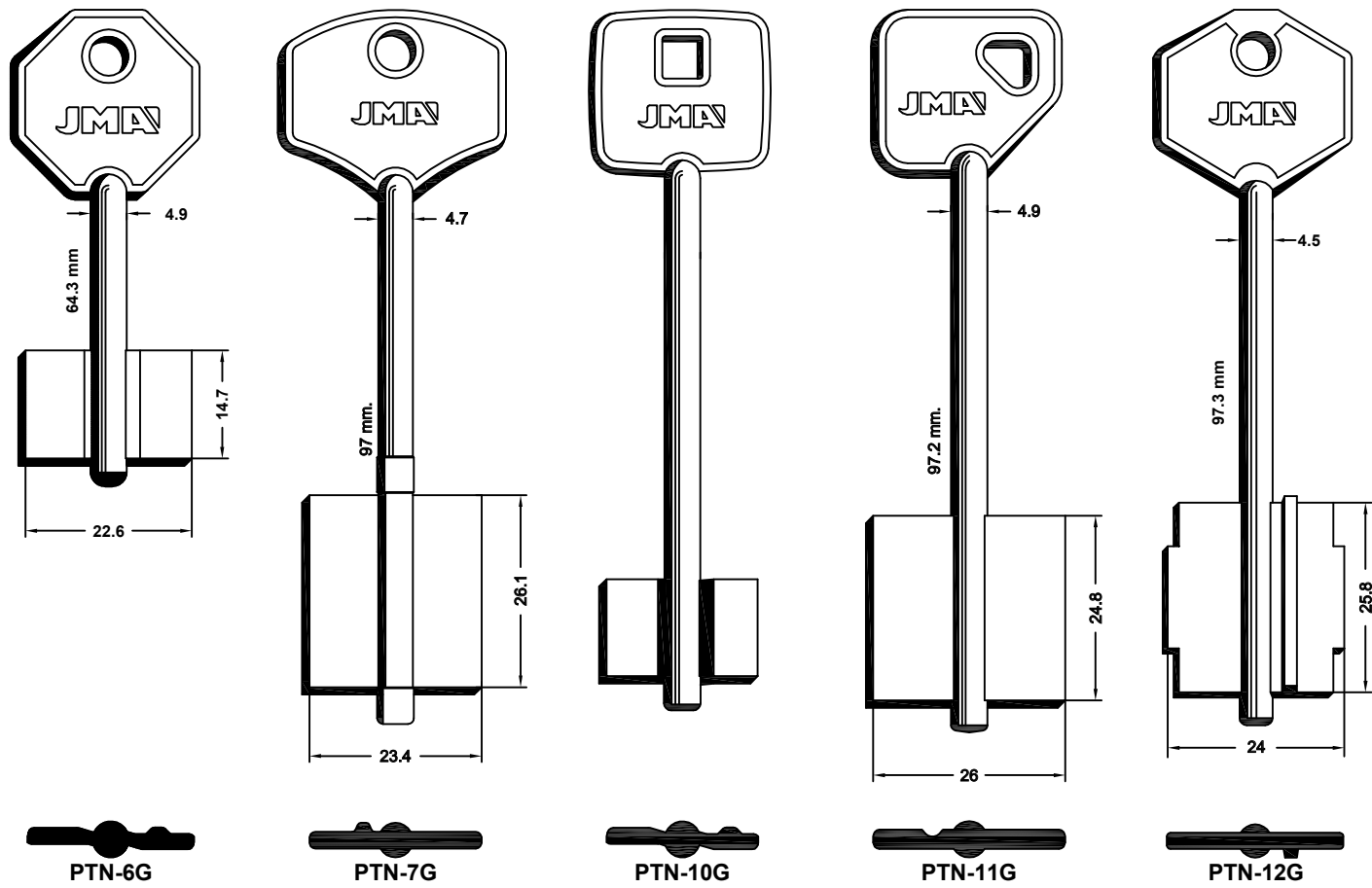

FOR: PREFER®

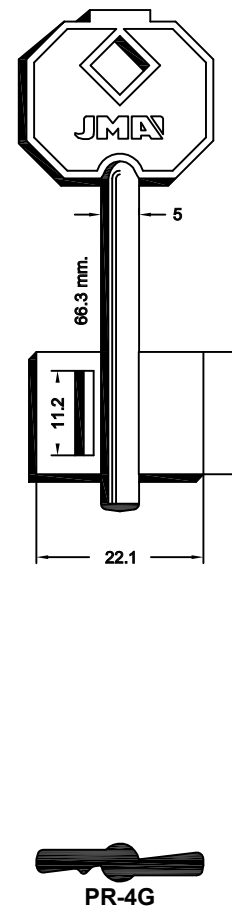

FOR: REVI®

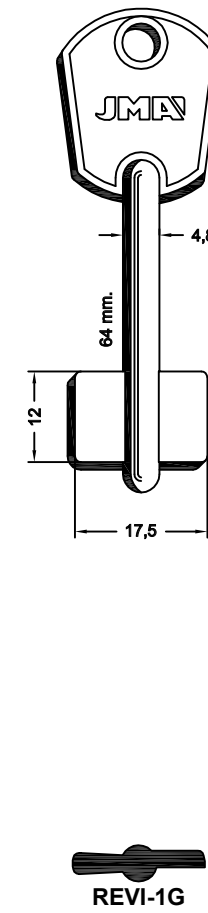

FOR: RIGAL®

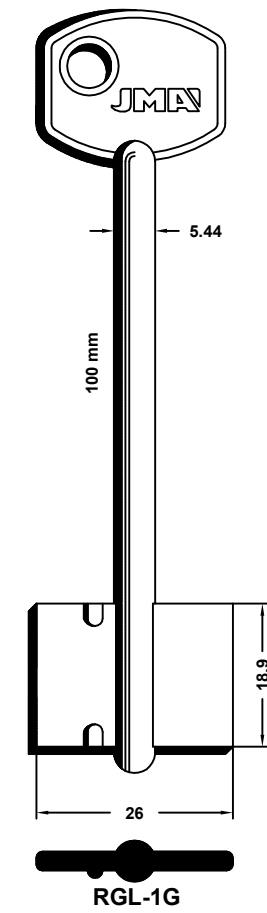

FOR: RUBEN®

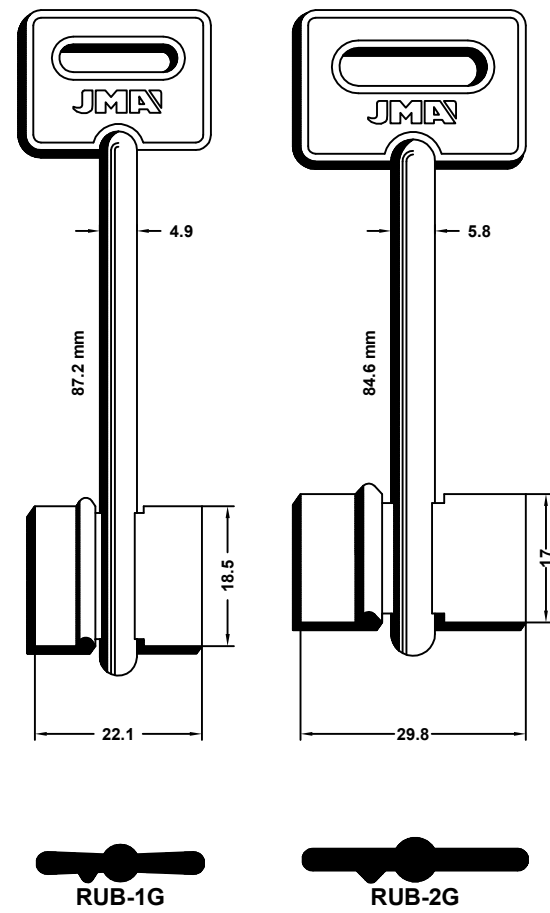

FOR: POTENT®

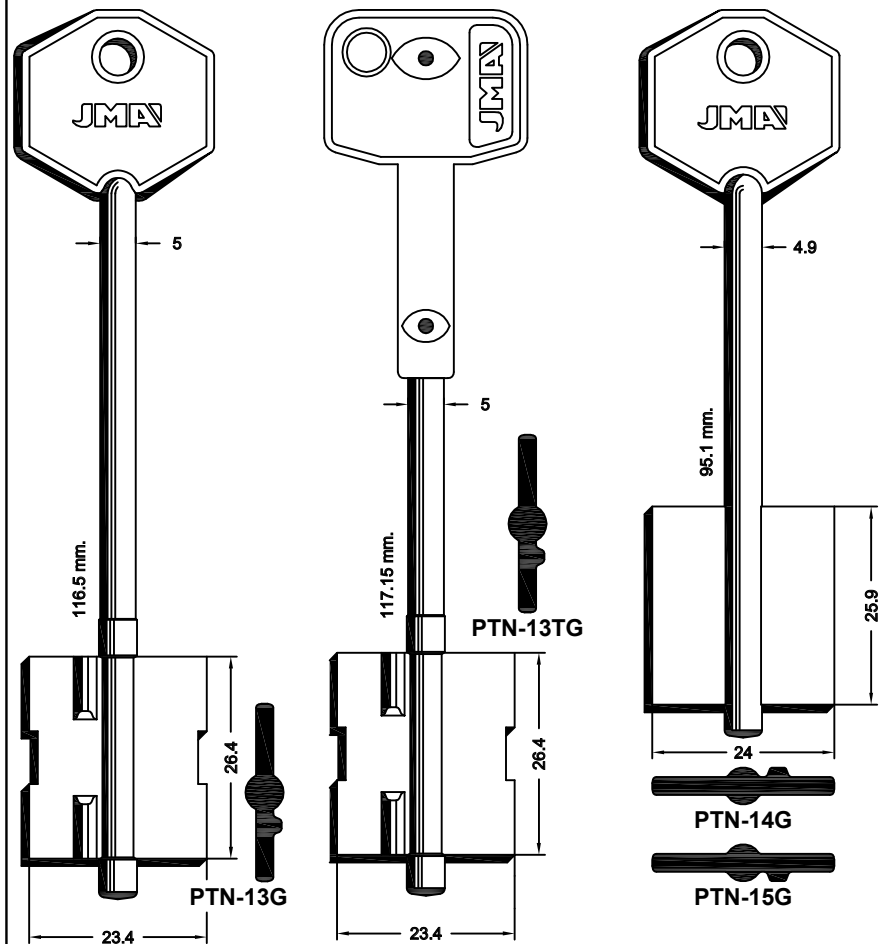

FOR: PREFER®

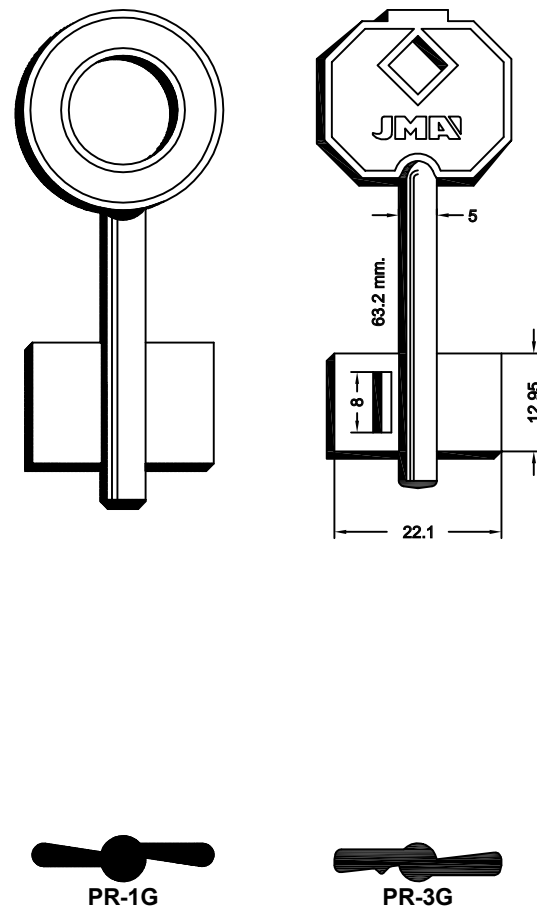

FOR: RUBEN®

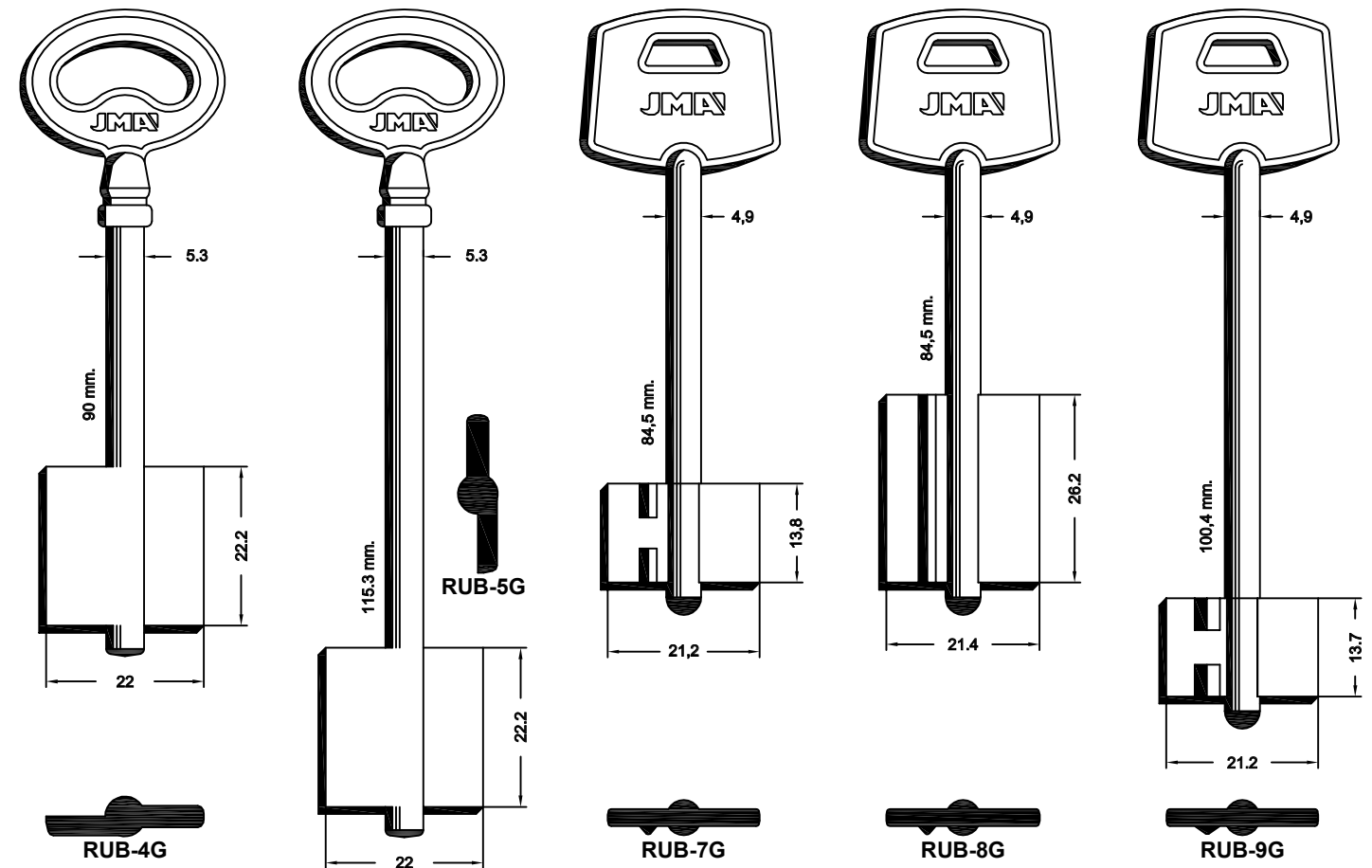

Concerning the marks and commercial denominations see legal warning.  
 Concerniente a las marcas y denominaciones comerciales ver aviso legal.  
 Marka eta izendapen komertzialiei dagokienez, ikus lege-oharra.  
 Concernant les marques et dénominations commerciales voir la note dans l'index.

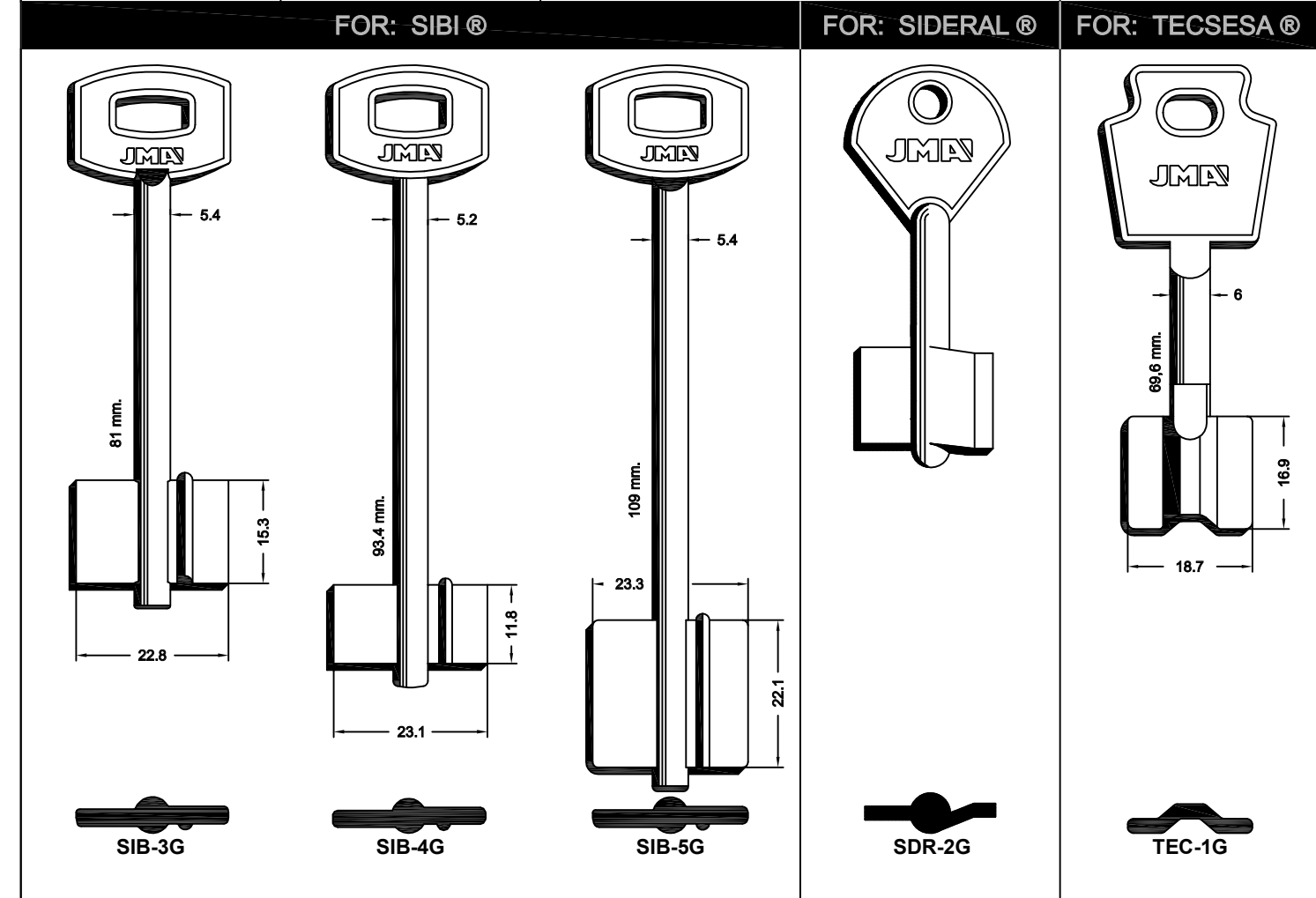
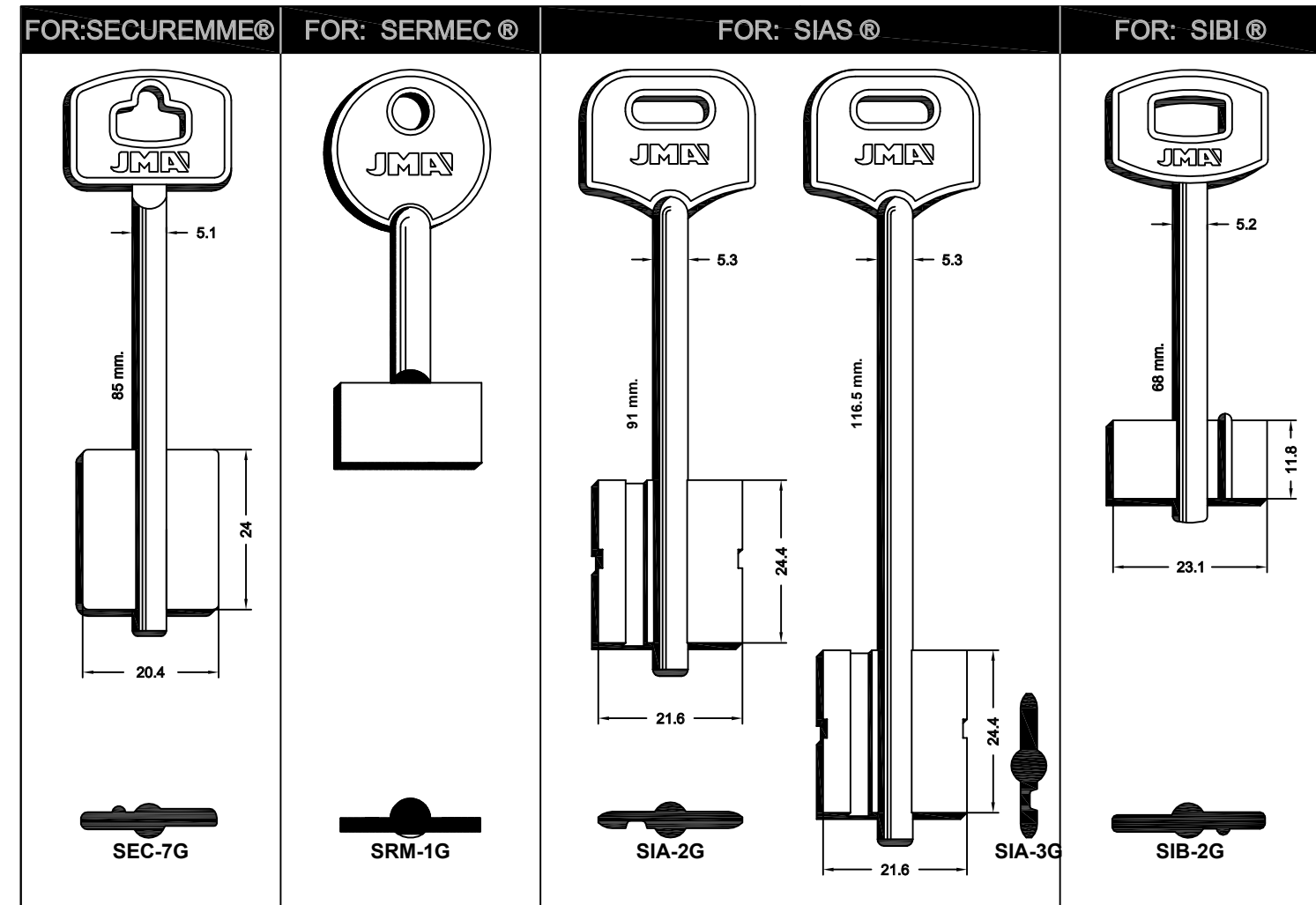
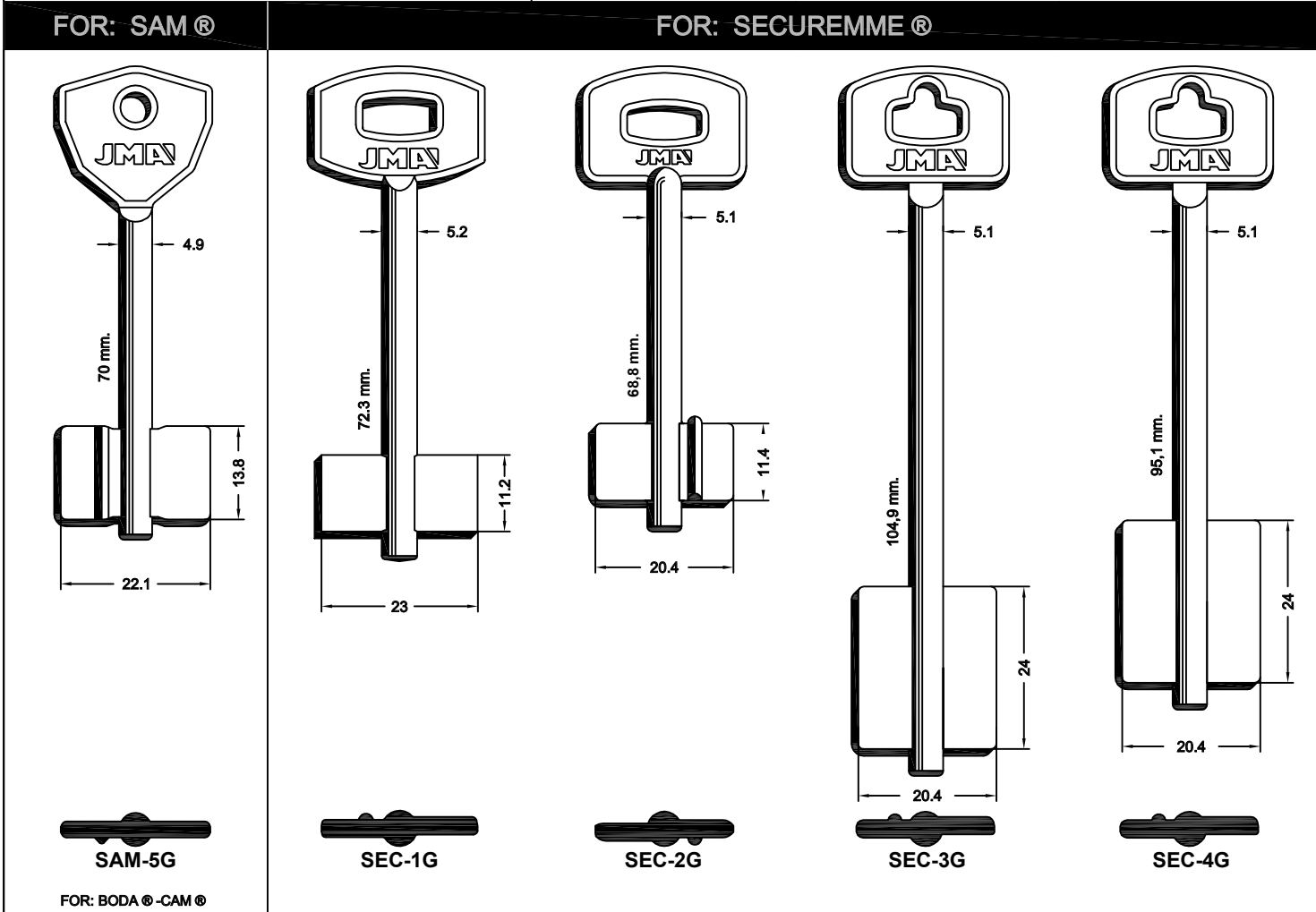
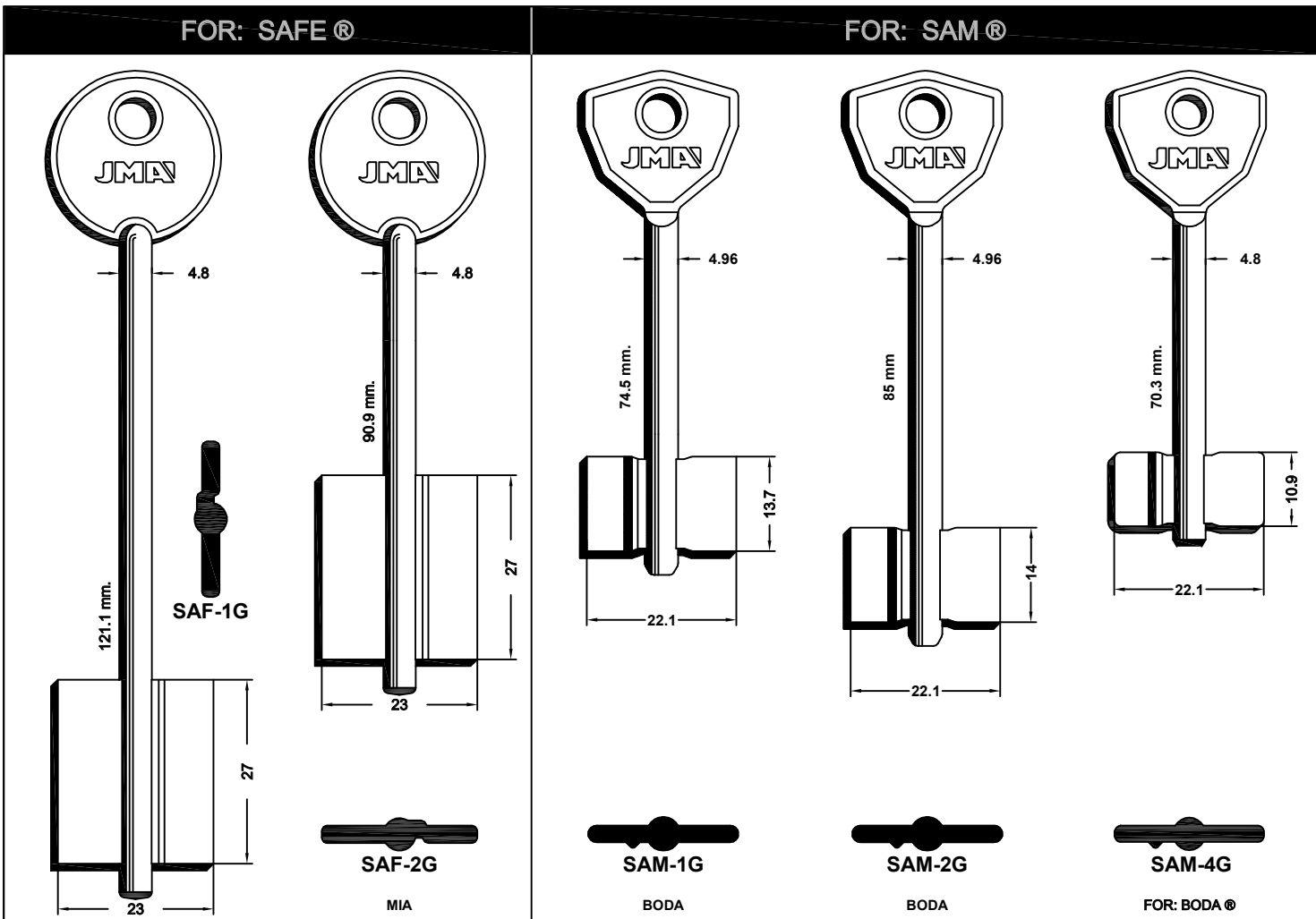

Concerning the marks and commercial denominations see legal warning.  
 Concerniente a las marcas y denominaciones comerciales ver aviso legal.  
 Marka eta izendapen komertzialiei dagokienez, ikus lege-oharra.  
 Concernant les marques et dénominations commerciales voir la note dans l'index.

**JMA** Opening the future

**JMA** Opening the future

Beziehen auf die Marke und Handelsname sehen Sie die Notiz im Index.  
 Relativamente às marcas e denominações comerciais, ver aviso legal.  
 Jeśli chodzi o znaki i nazwy handlowe, patrz Informacje prawne.

FOR: TESIO®	FOR: TITANO®		FOR: TOVER®	FOR: 4 TR®
<p>4.8 90.6 mm. 25.5 22.8</p> <p>TSI-1G</p>	<p>TTN-1G</p>	<p>TTN-2G</p>	<p>6.2 59.05 mm 11.95 15.9</p> <p>TOV-1G</p>	<p>TR-1G</p>

FOR: YALE®	
<p>YA-3G</p>	<p>YA-4G</p>

FOR: TUSHINO®	FOR: WELKA®		FOR: YALE®	
<p>4.9 53 mm 12 18</p> <p>TUS-1G</p>	<p>WE-1G</p>	<p>WE-2G</p>	<p>YA-1G</p>	<p>YA-2G</p>

<p>62.3 6.1 20.35 4.1 17.9 51G</p>	<p>72 6 17.9 15.9 52 GPC</p>	<p>72 6.15 20.25 4.1 22.2 52G</p>	<p>80.9 6.15 20.1 4.1 19.1 53G</p>	<p>90 6 23 21 54G</p>
--	--	---	--	---------------------------------------

Concerning the marks and commercial denominations see legal warning.  
 Concerniente a las marcas y denominaciones comerciales ver aviso legal.  
 Marka eta izendapen komertzialiei dagokienez, ikus lege-oharra.  
 Concernant les marques et dénominations commerciales voir la note dans l'index.

**JMA®** Opening the future

**JMA®** Opening the future

Beziehen auf die marke und handelsname sehen sie die notiz im index.  
 Relativamente às marcas e denominações comerciais, ver aviso legal.  
 Jeśli chodzi o znaki i nazwy handlowe, patrz Informacje prawne.

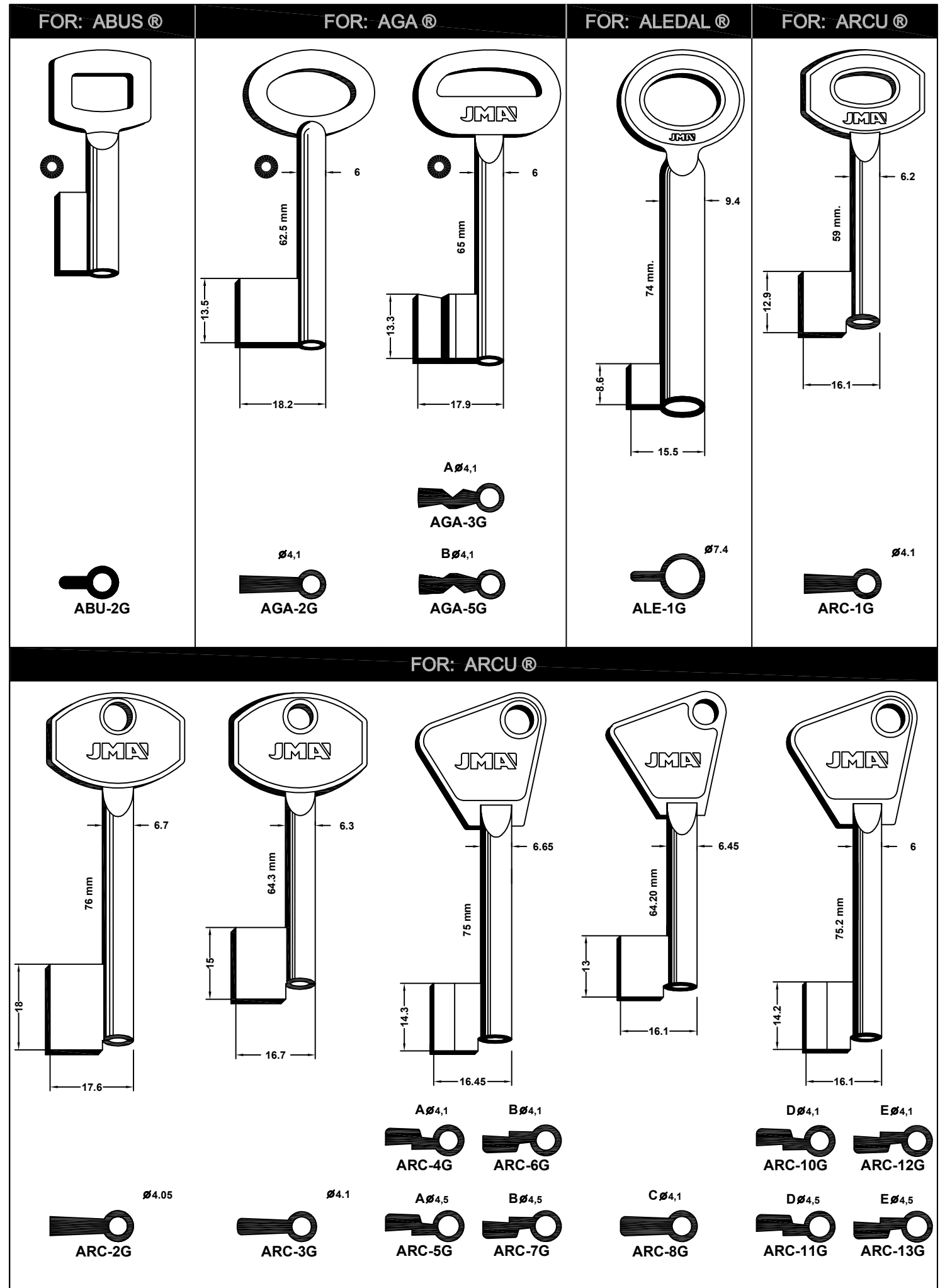
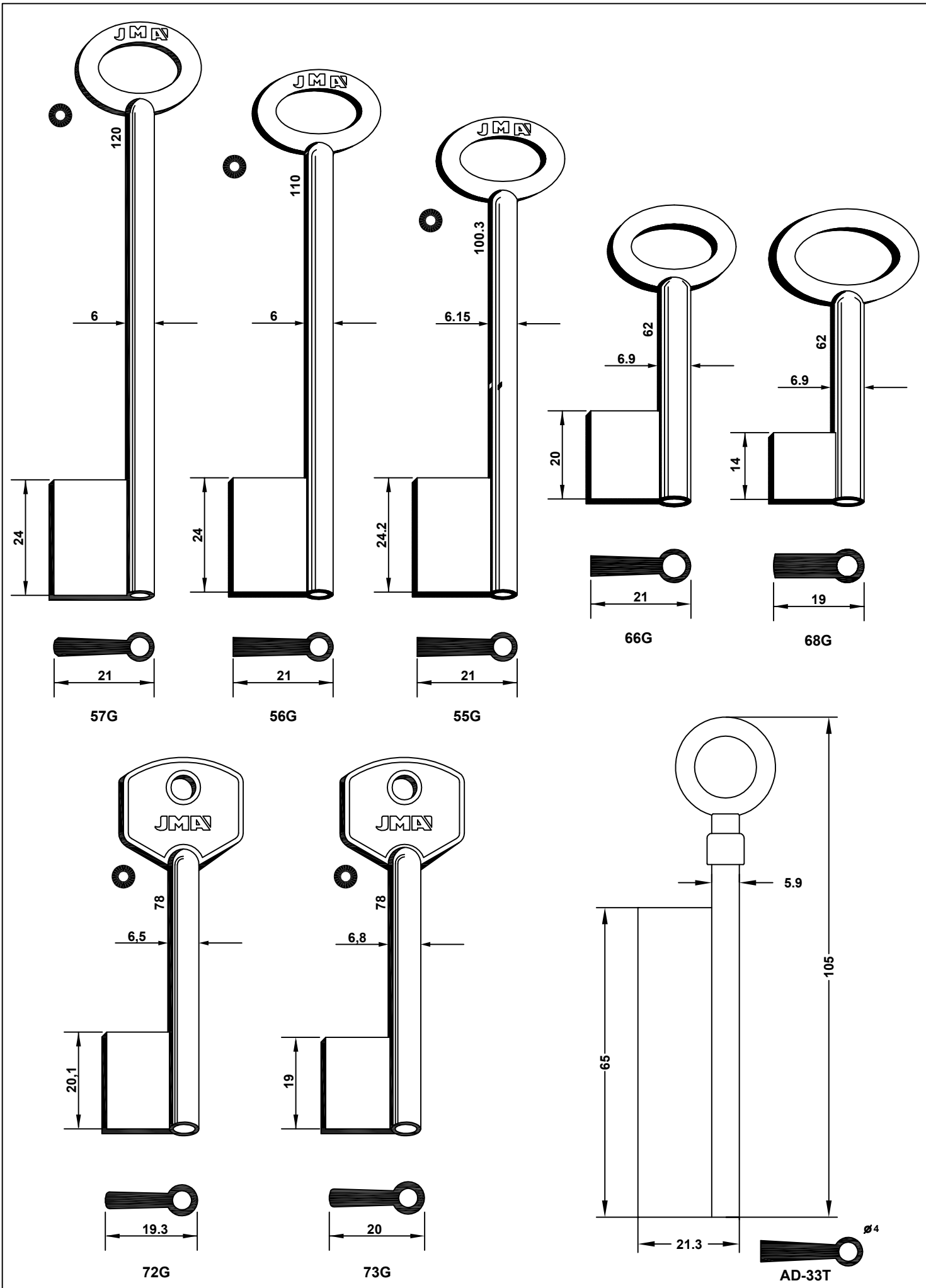

Concerning the marks and commercial denominations see legal warning.  
 Concerniente a las marcas y denominaciones comerciales ver aviso legal.  
 Marka eta izendapen komertzialiei dagokienez, ikus lege-oharra.  
 Concernant les marques et dénominations commerciales voir la note dans l'index.

**JMA** Opening the future

**JMA** Opening the future

Beziehen auf die Marke und Handelsname sehen Sie die Notiz im Index.  
 Relativamente às marcas e denominações comerciais, ver aviso legal.  
 Jeśli chodzi o znaki i nazwy handlowe, patrz Informacje prawne.



FOR: ARCU®

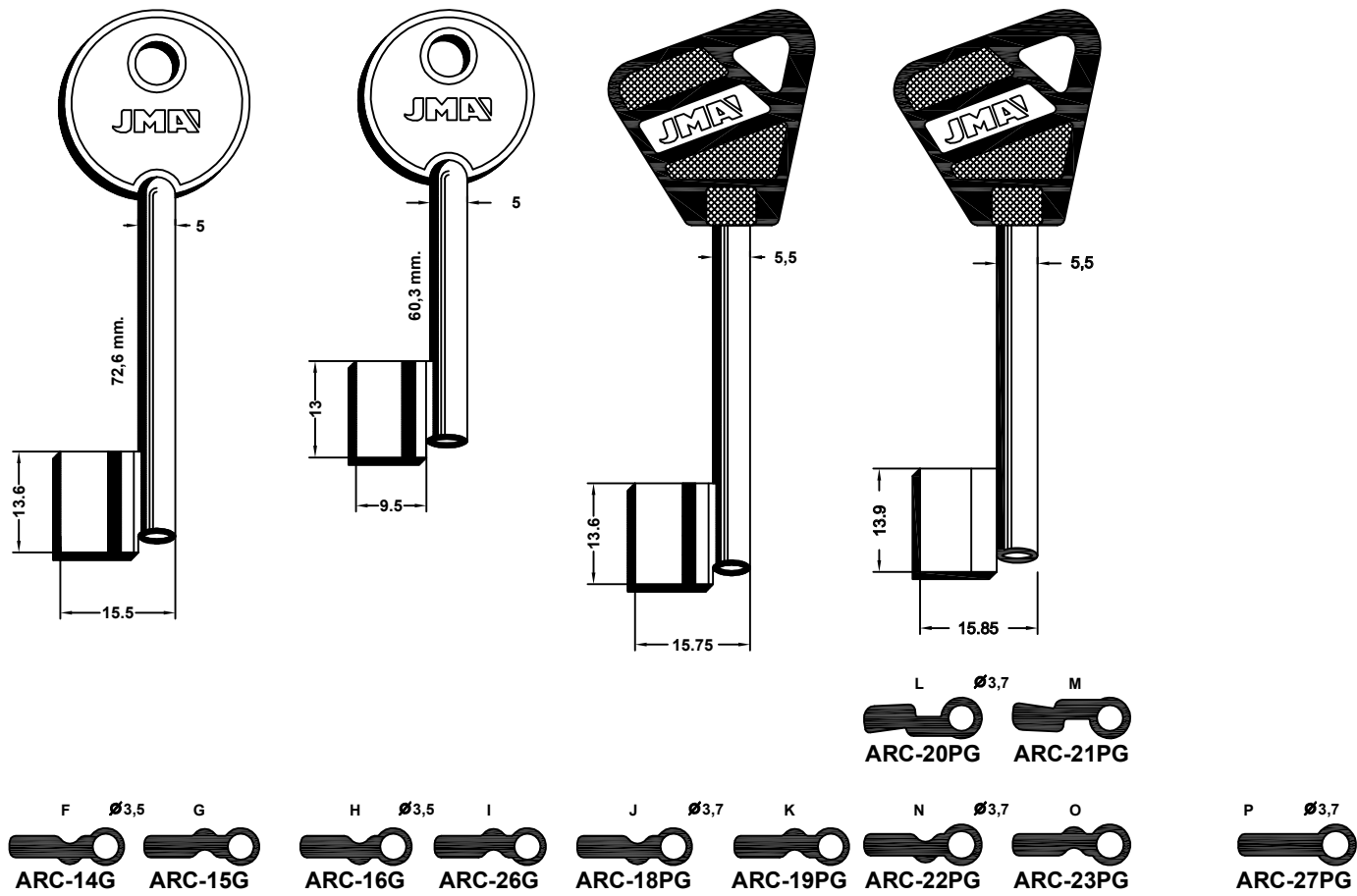

FOR: LAR®

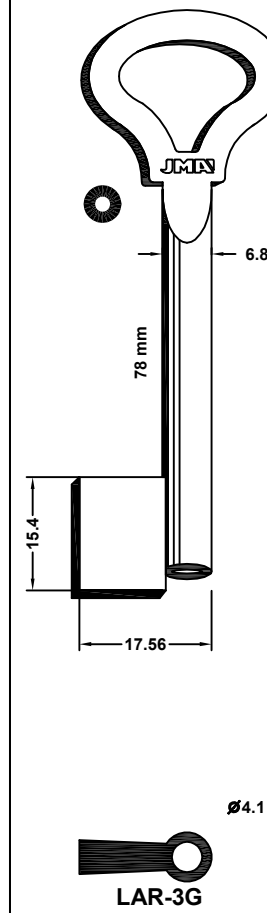

FOR: ORENGO®

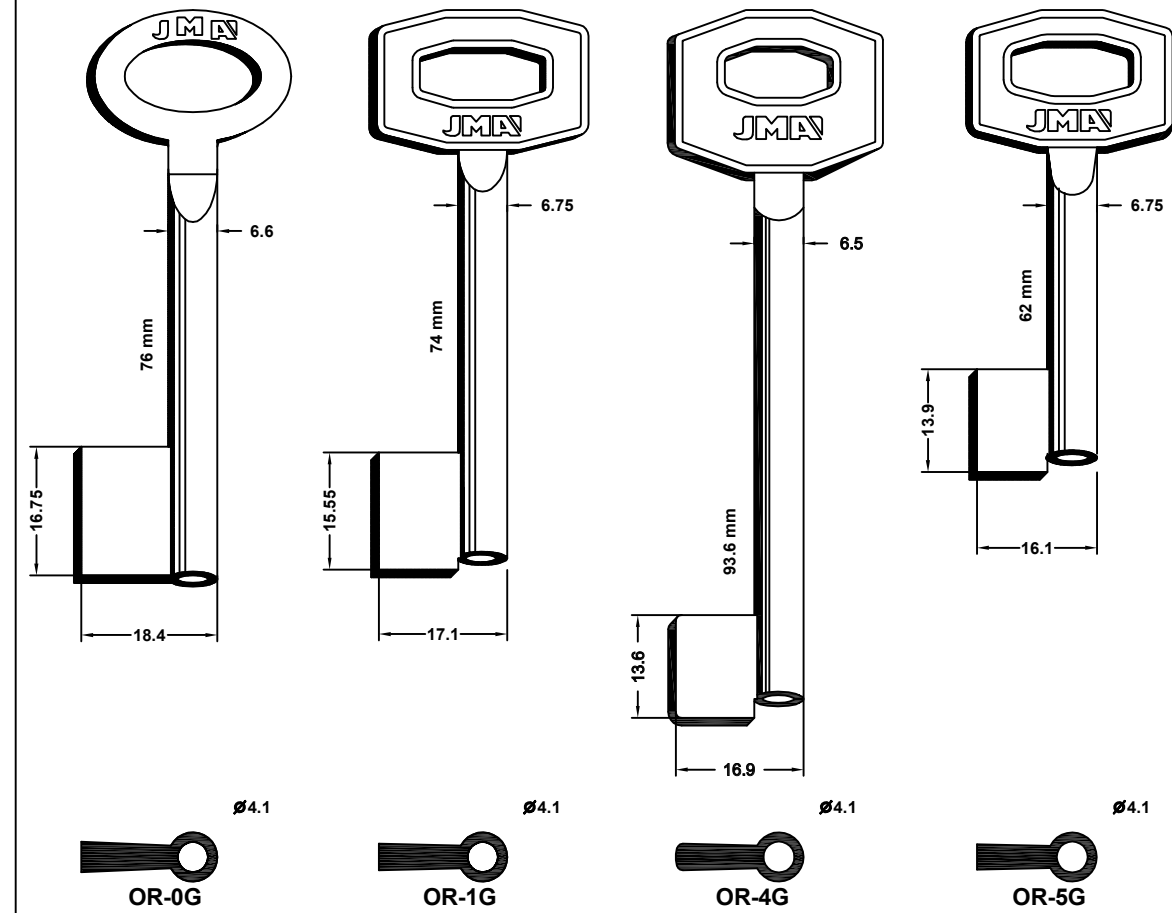

FOR: ARCU®

FOR: ASSA®

FOR: AYPE®

FOR: CERUTTI®

FOR: LAR®

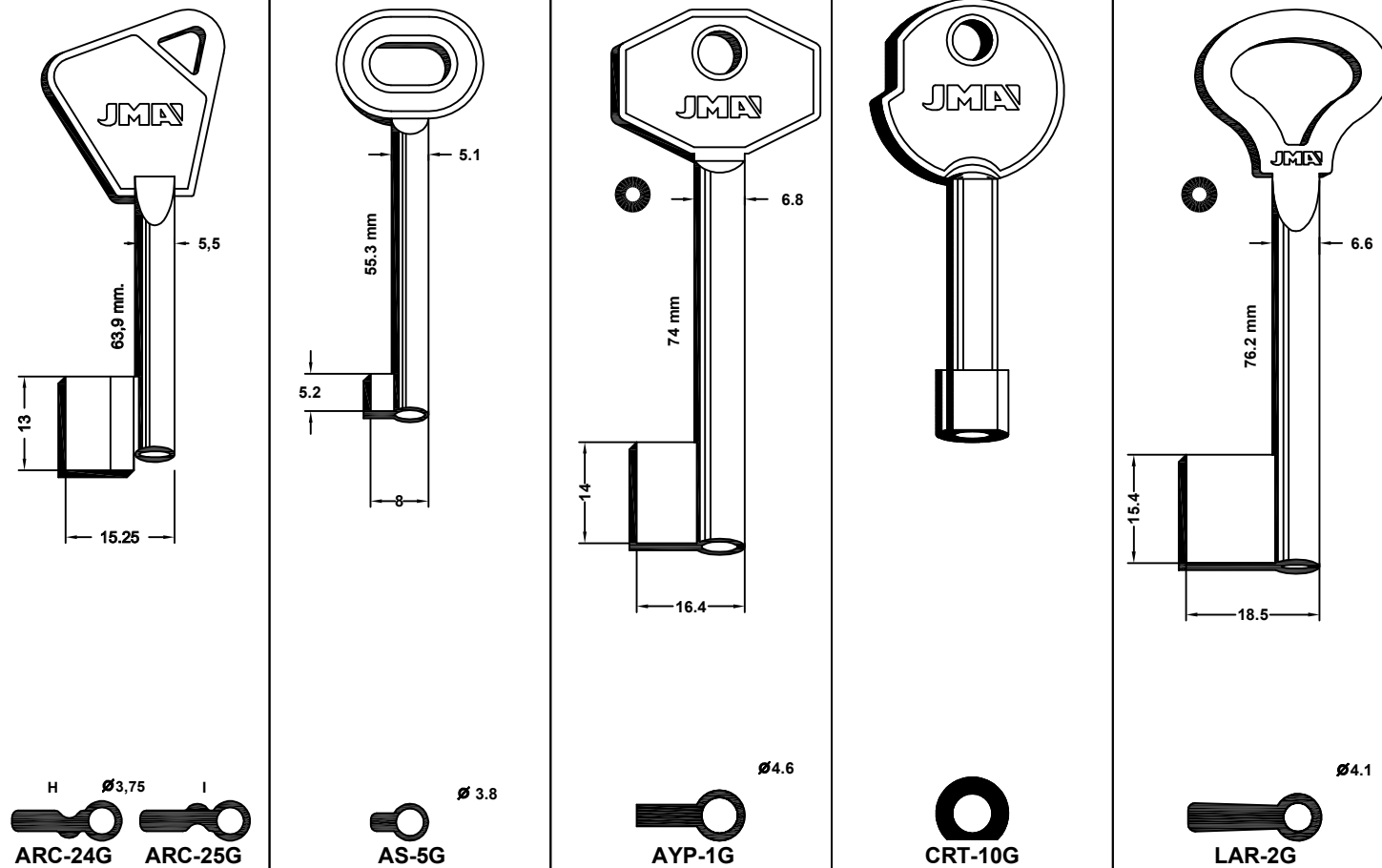

FOR: RUBEN®

FOR: RUE®

FOR: VACHETTE®

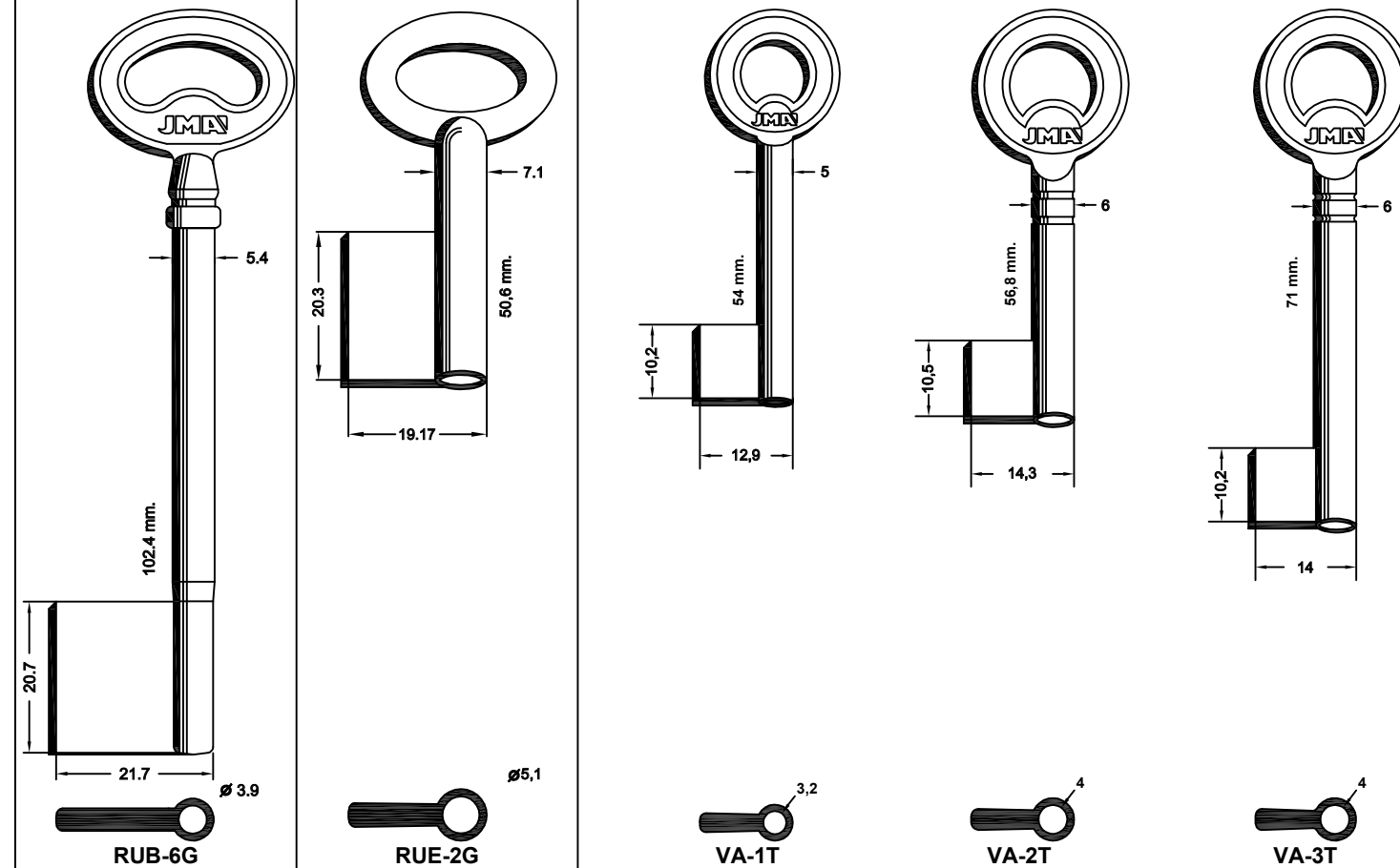

Concerning the marks and commercial denominations see legal warning.  
 Concerniente a las marcas y denominaciones comerciales ver aviso legal.  
 Marka eta izendapen komertzialiei dagokienez, ikus lege-oharra.  
 Concernant les marques et dénominations commerciales voir la note dans l'index.



FOR: VACHETTE®

FOR: VILLFER®

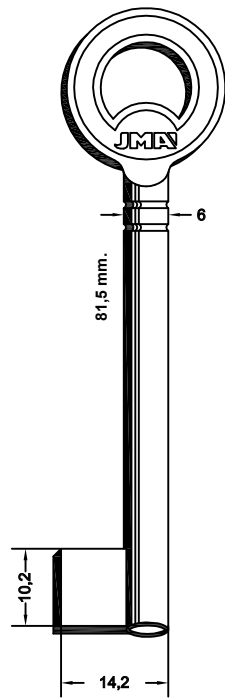

VA-5T

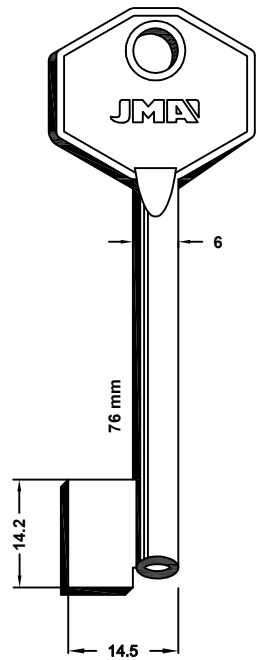

VILL-1G

FOR: AGA®

FOR: ARES®

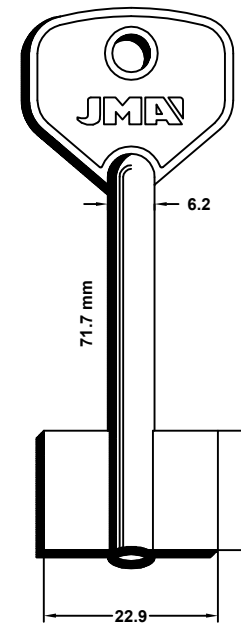

AGA-7G

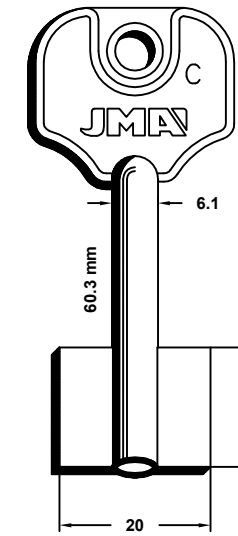

AGA-8G  
FOR: ARFE®

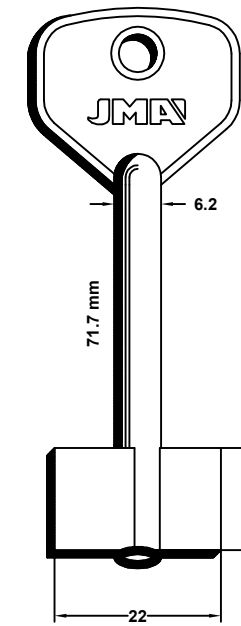

AGA-9G

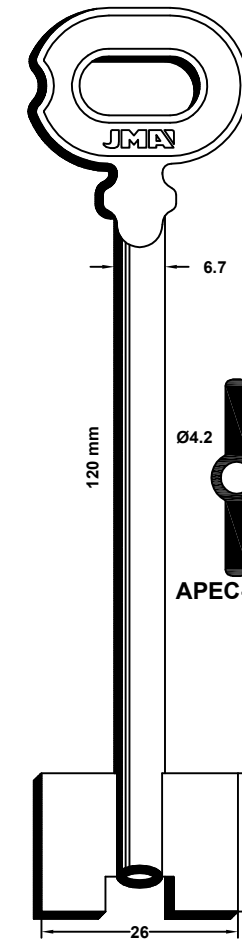

APEC-1G

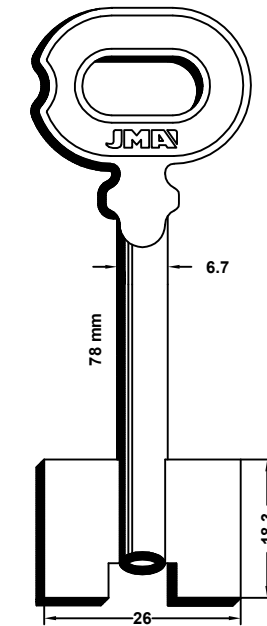

APEC-2G

FOR: AGA®

FOR: BURG®

FOR: CRONOS®

FOR: DUPLEX®

FOR: DVERNIAK®

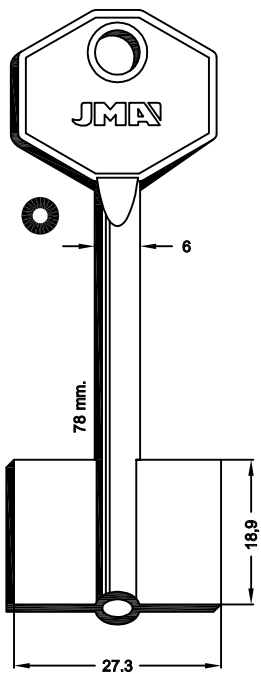

101G

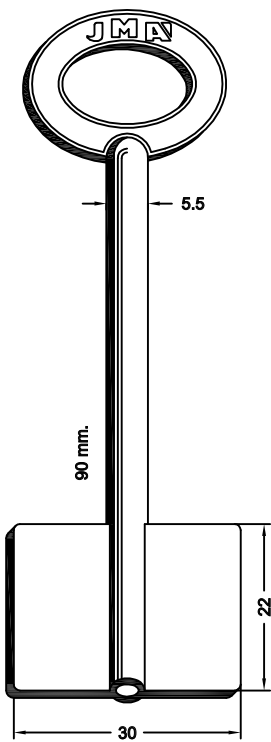

AD-46

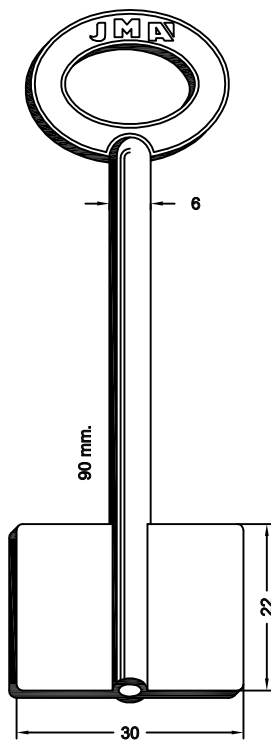

AD-47

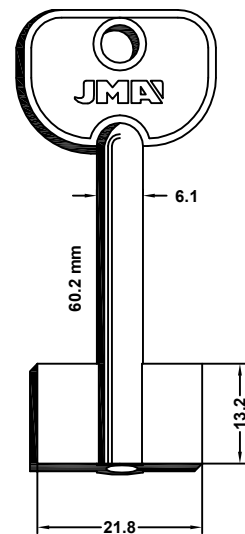

AGA-4G  
FOR: FECOR®

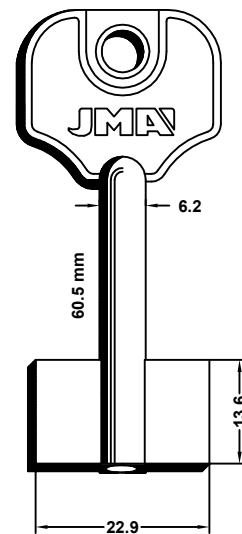

AGA-6G  
FOR: ARFE®

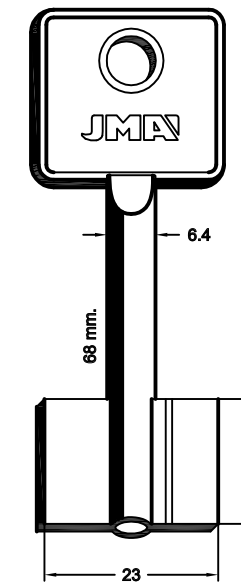

BUR-1G

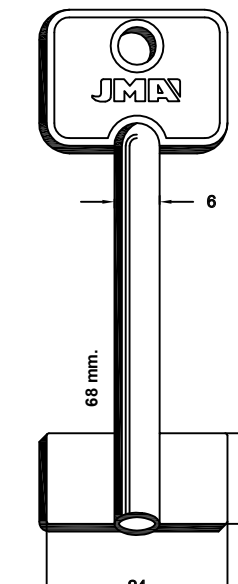

CRO-1G

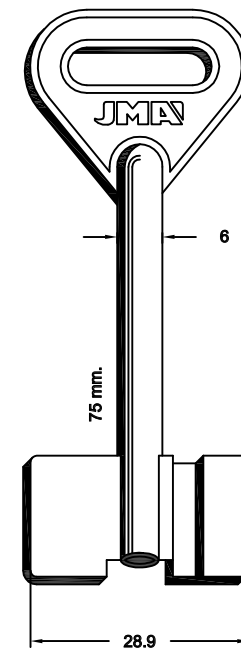

DUP-1G

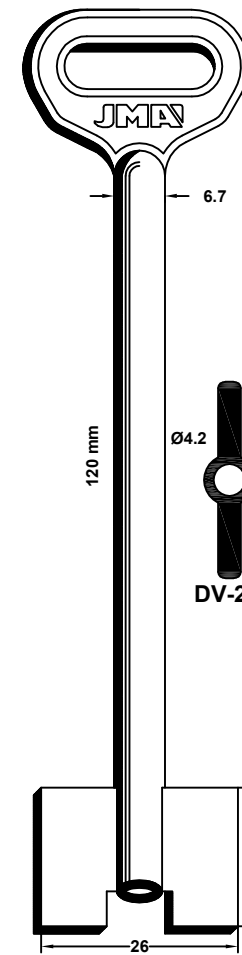

DV-2G

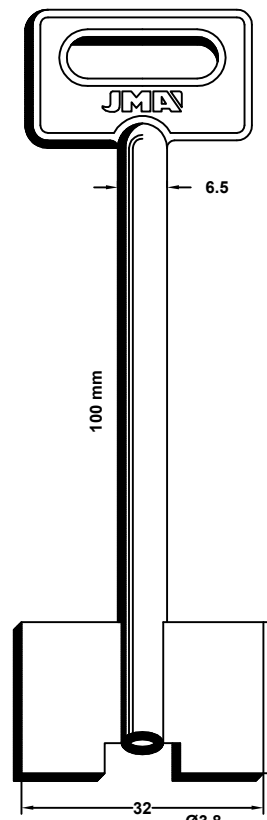

DV-4G

Concerning the marks and commercial denominations see legal warning.  
 Concerniente a las marcas y denominaciones comerciales ver aviso legal.  
 Marka eta izendapen komertzialiei dagokienez, ikus lege-oharra.  
 Concernant les marques et dénominations commerciales voir la note dans l'index.

FOR: DVERNIAK®				FOR: EREVAN®
<p>DV-10G/A</p>	<p>DV-11G</p>	<p>DV-13G/A</p>	<p>DV-17G</p>	<p>ERV-3G/A</p>

FOR: SERRALLER®	FOR: SIBI®
<p>SER-1G FOR: ARFE®</p>	<p>SIB-1G FOR: ARFE®</p>

FOR: MACOR®	FOR: MAXIM®		FOR: PREFER®	FOR: RUBEN®
<p>MAC-1G</p>	<p>MAX-1G</p>	<p>MAX-2G</p>	<p>PR-2G</p>	<p>RUB-3G</p>

Concerning the marks and commercial denominations see legal warning.  
 Concerniente a las marcas y denominaciones comerciales ver aviso legal.  
 Marka eta izendapen komertzialiei dagokienez, ikus lege-oharra.  
 Concernant les marques et dénominations commerciales voir la note dans l'index.

**JMA®** Opening the future

**JMA®** Opening the future

Beziehen auf die Marke und Handelsname sehen sie die Notiz im Index.  
 Relativamente às marcas e denominações comerciais, ver aviso legal.  
 Jeśli chodzi o znaki i nazwy handlowe, patrz Informacje prawne.







# ZAMAK

## MORTICE KEYS

Llaves de Gorja  
Gorja motako giltzak

Clés à gorge  
Tresor-Schlüssel

Chaves de gorja  
Klucze zasuwowe

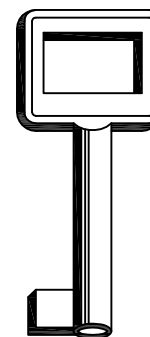
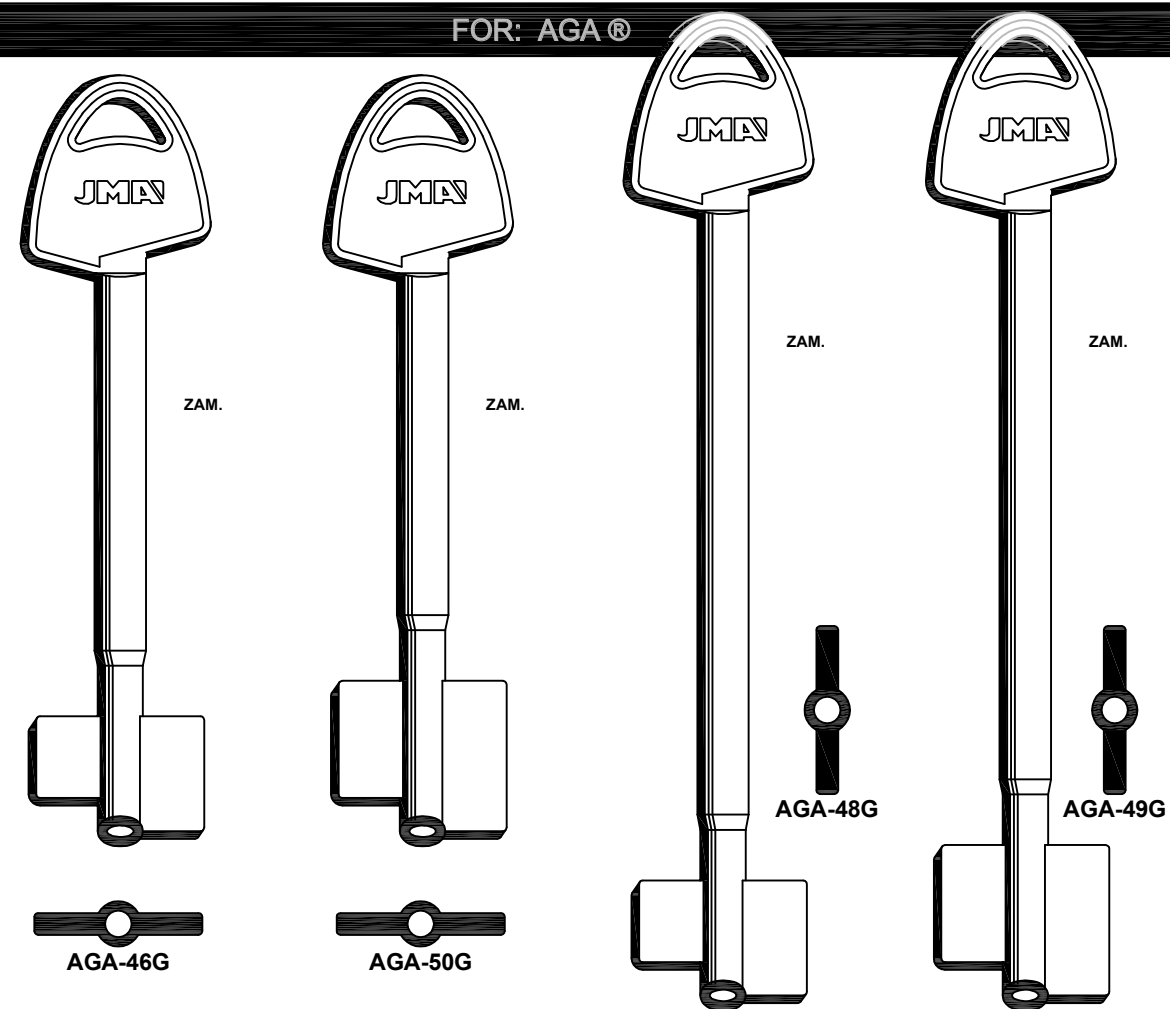
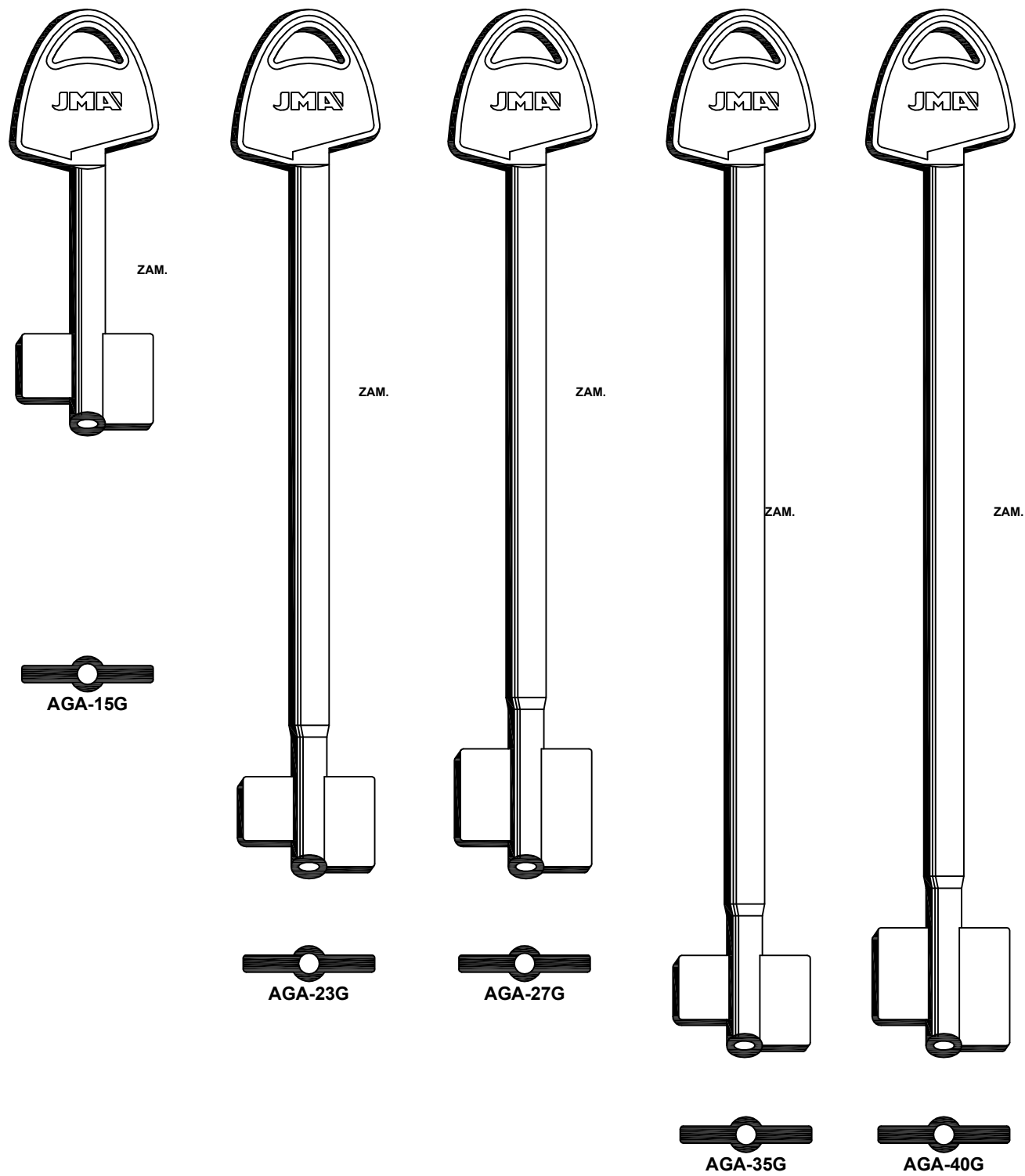

ZAM.



CIS-803/....

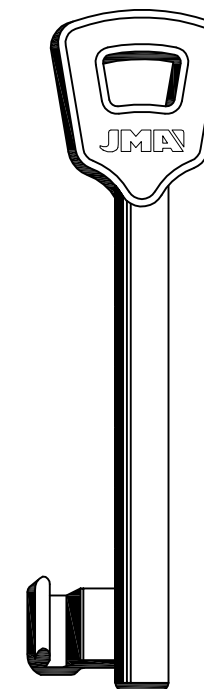

NEF-2Z-..



ZAM.

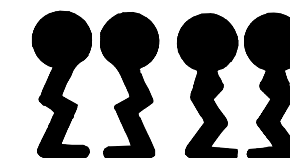
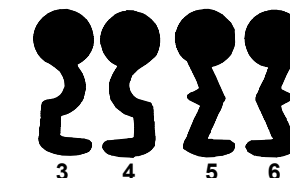

FOR: BMH® -FH® -VACHETTE®

Concerning the marks and commercial denominations see legal warning.  
 Concerniente a las marcas y denominaciones comerciales ver aviso legal.  
 Marka eta izendapen komertzialiei dagokienez, ikus lege-oharra.  
 Concernant les marques et dénominations commerciales voir la note dans l'index.



## WARDROBE KEYS

Llaves artísticas  
Giltza artistikoak

Clés artistiques/de style  
Künstlerische Schlüssel

Chaves artísticas  
Klucze ozdobne

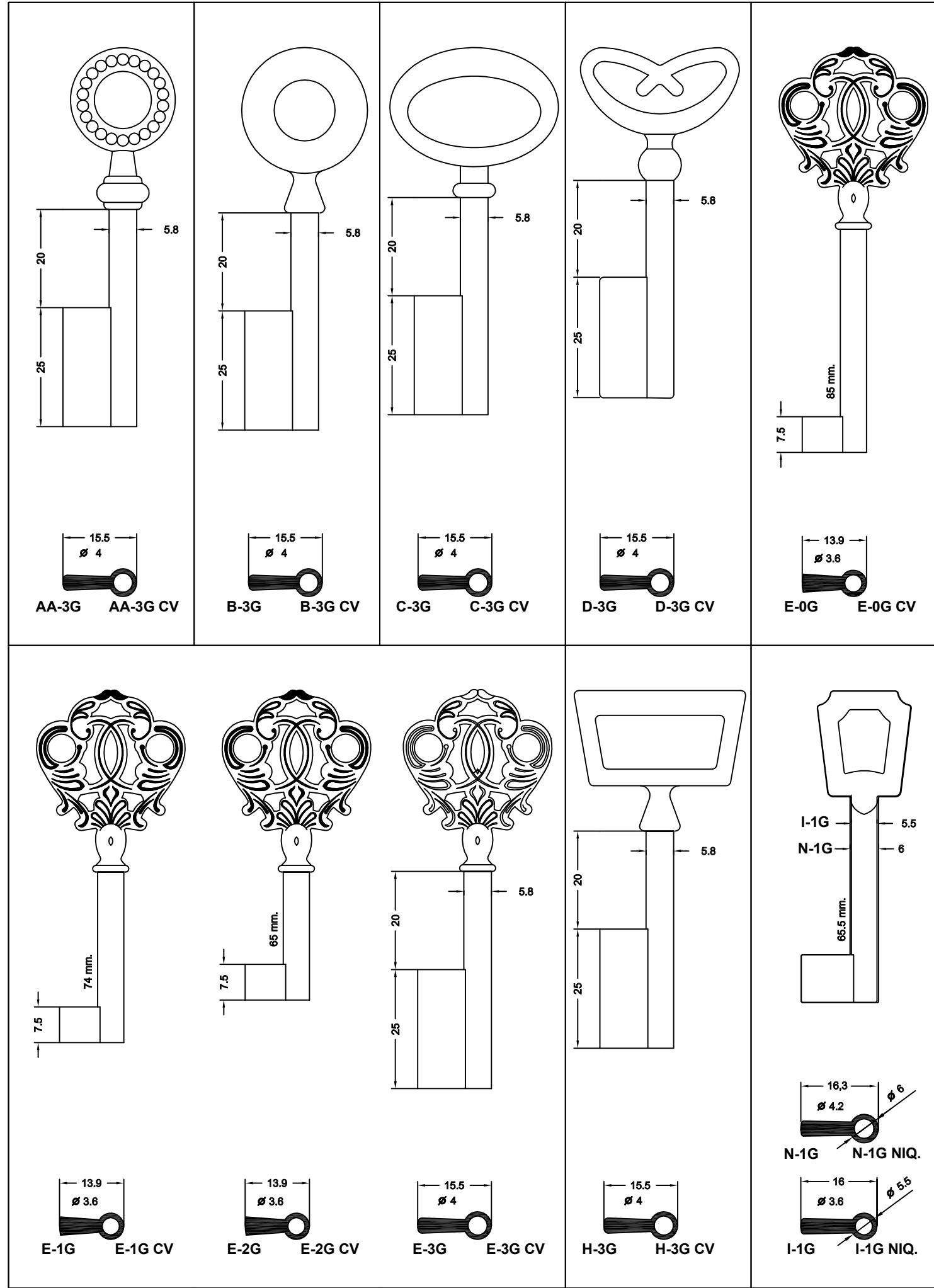
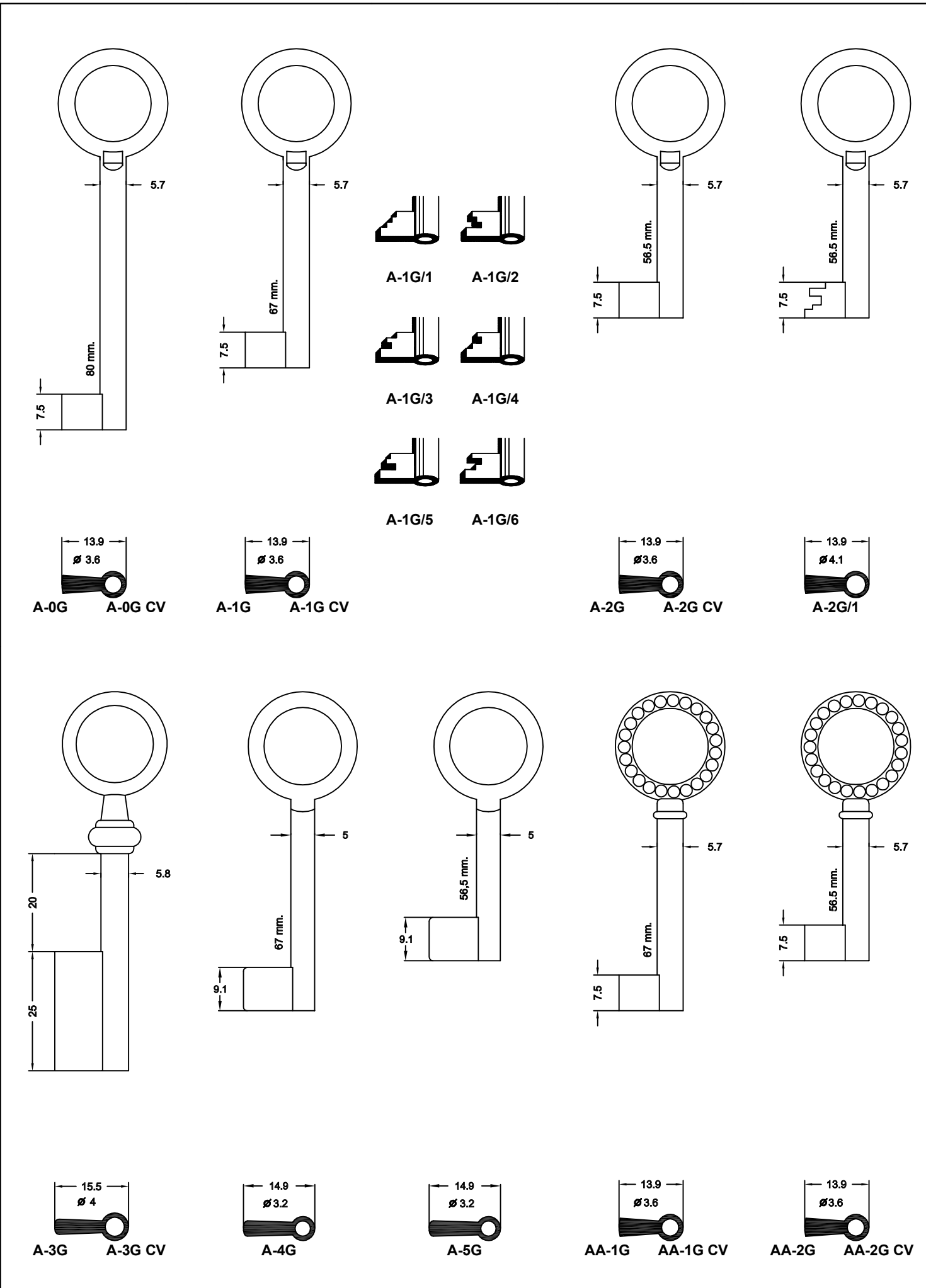

Concerning the marks and commercial denominations see legal warning.  
 Concerniente a las marcas y denominaciones comerciales ver aviso legal.  
 Marka eta izendapen komertzialiei dagokienez, ikus lege-oharra.  
 Concernant les marques et dénominations commerciales voir la note dans l'index.



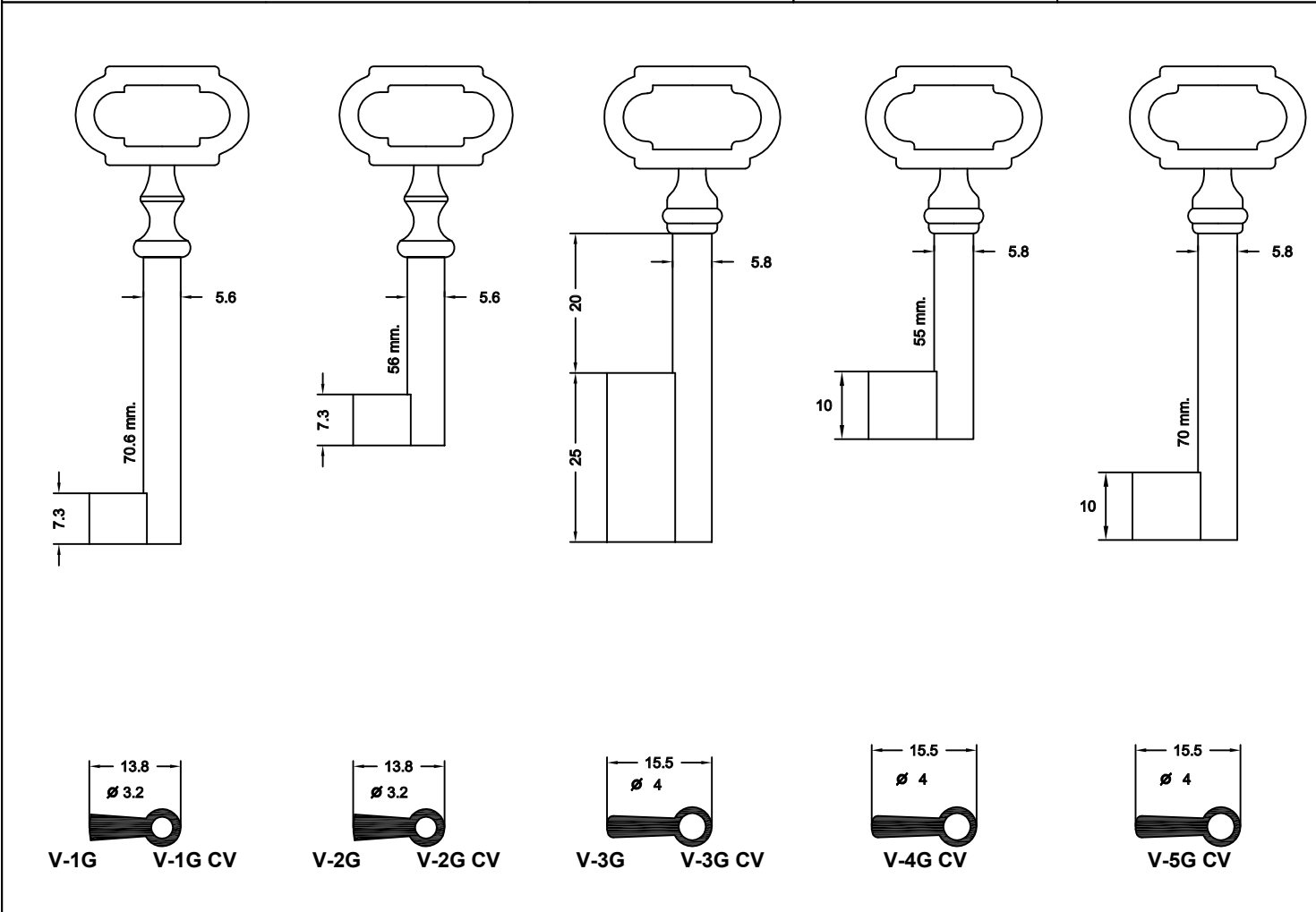
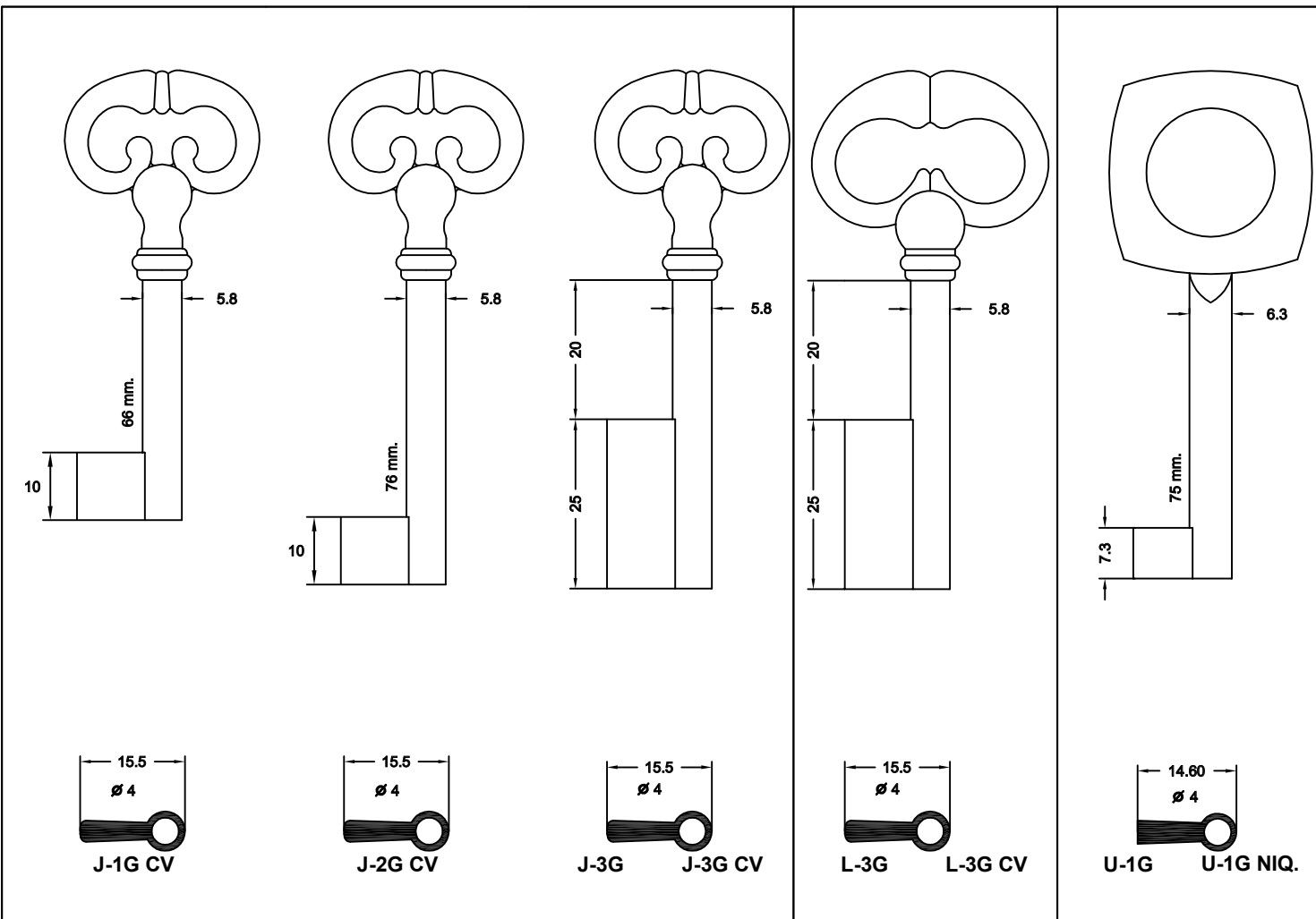

## LIFT AND MAIL BOX KEYS

Llaves para casillas  
Kutxatilarako giltzak

Clés pour casiers  
Künstlerische Schlüssel

Chaves para caixas  
Klucze do szafek

Concerning the marks and commercial denominations see legal warning.  
Concerniente a las marcas y denominaciones comerciales ver aviso legal.  
Marka eta izendapen komertzialiei dagokienez, ikus lege-oharra.  
Concernant les marques et dénominations commerciales voir la note dans l'index.

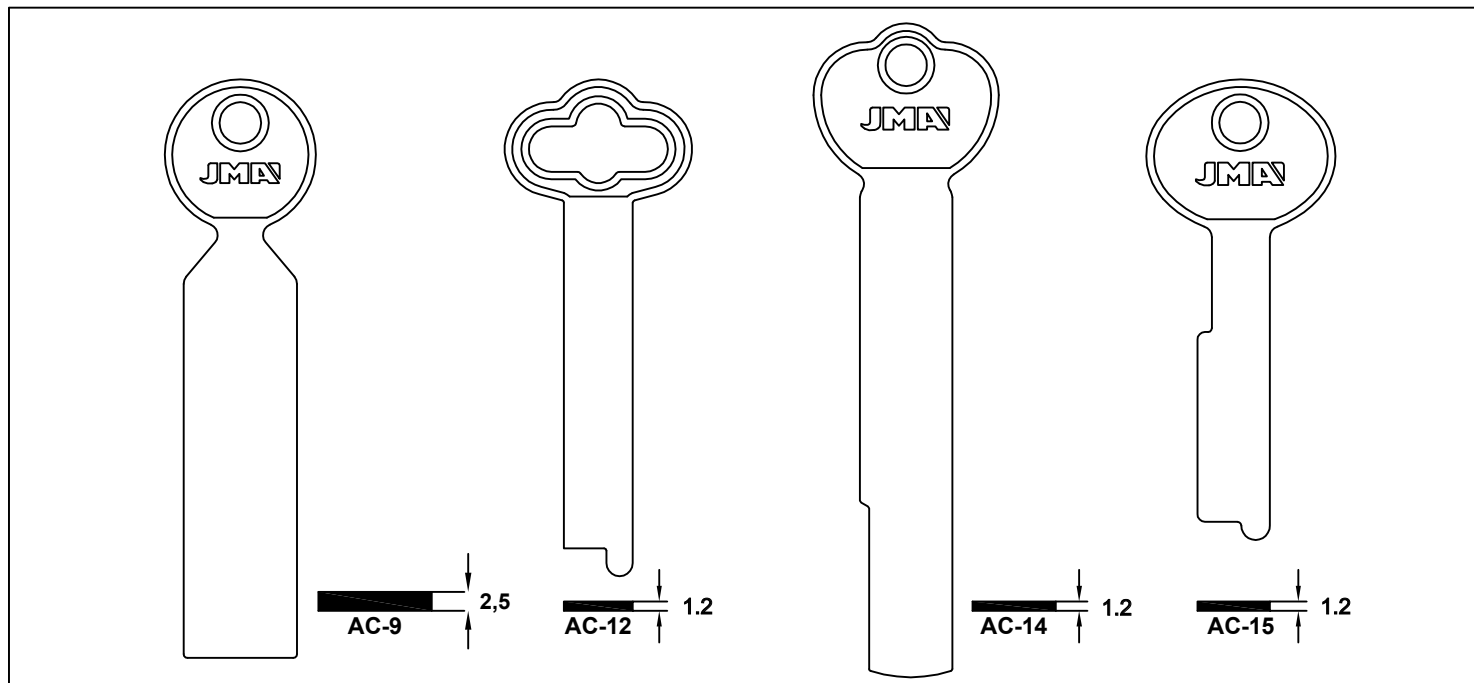

FOR: DIEBOLD®      FOR: MILES®      FOR: MUEL®

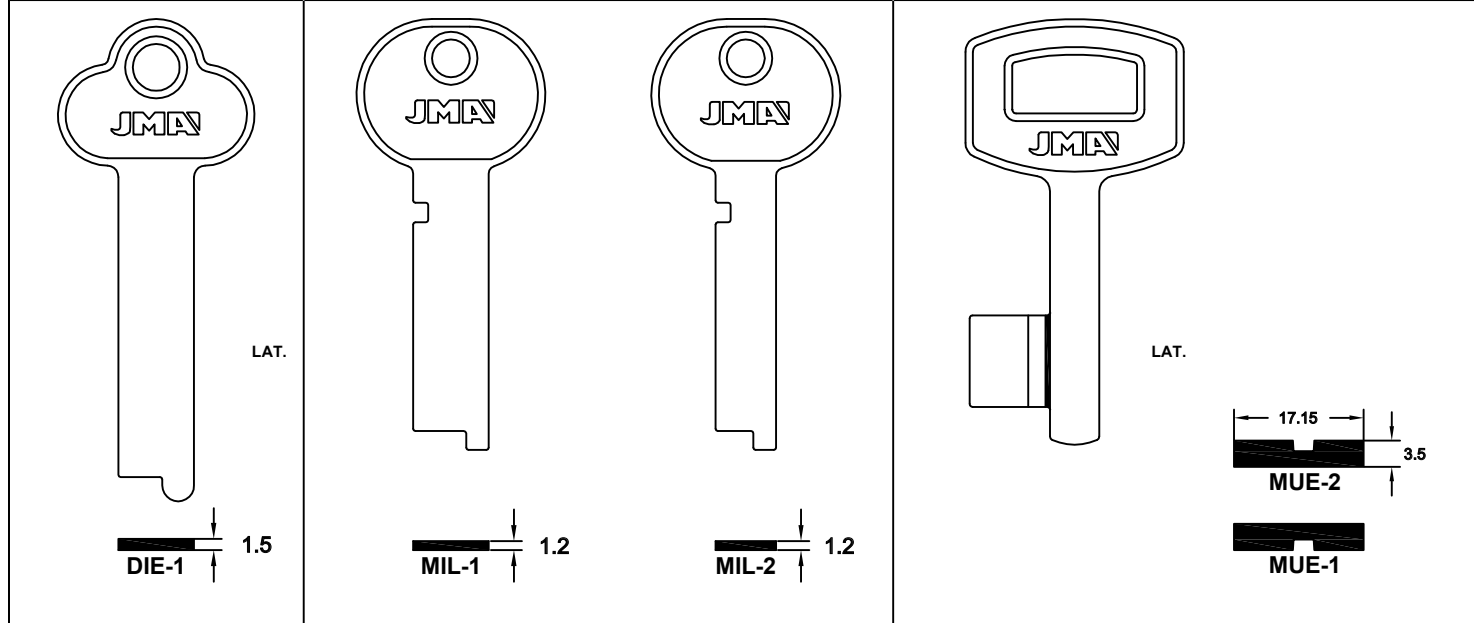

FOR: RIL®      FOR: SERRETA®      FOR: URKO®      FOR: YALE®

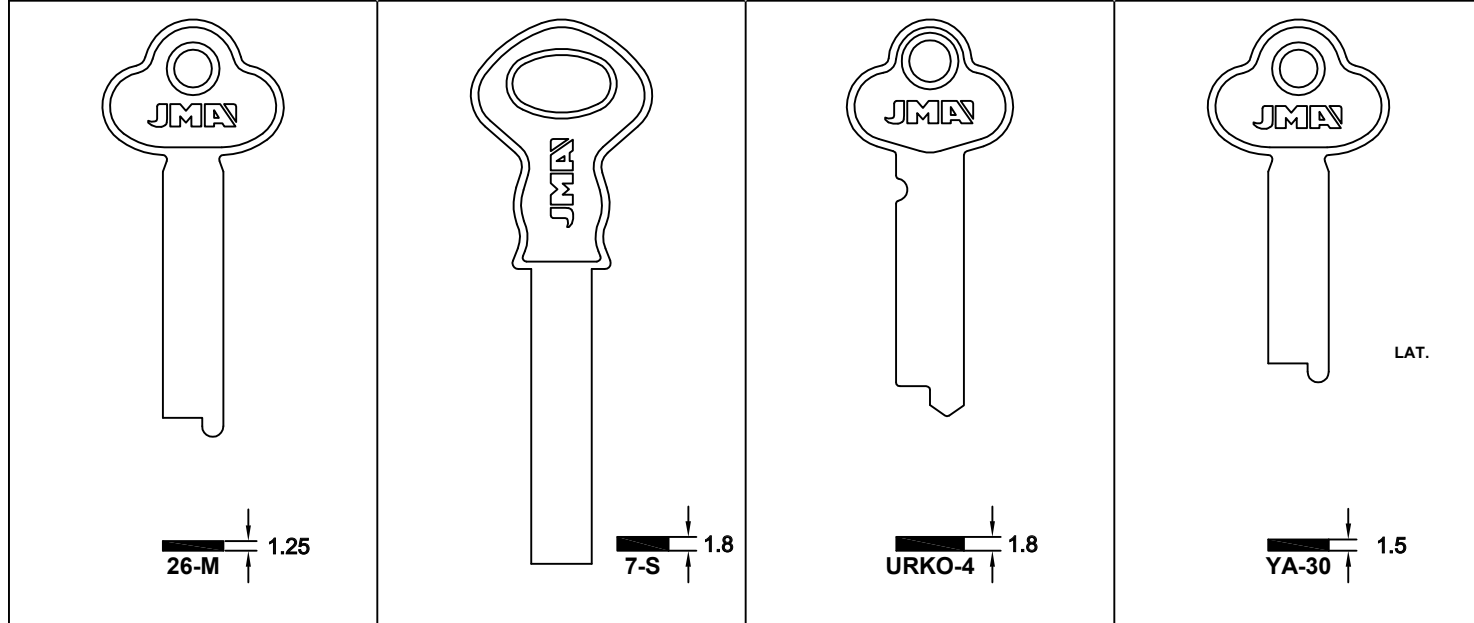

# Guide

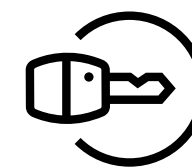

**BRAND GUIDES. AUTOMOTIVE**

Guía de marcas. Automoción  
 Marken gida. Automozioia  
 Guide des marques. Automobile  
 Markenindex. Automobilindustrie  
 Índice de marcas. Automóbel  
 Spis marek. Samochodowe

Concerning the marks and commercial denominations see legal warning.  
 Concerniente a las marcas y denominaciones comerciales ver aviso legal.  
 Marka eta izendapen komertzialiei dagokienez, ikus lege-oharra.  
 Concernant les marques et dénominations commerciales voir la note dans l'index.

Automóvil. Camioneta  
Automobila. Kamioneta  
Voiture. Camionnette

Auto. Kleintransporter  
Automóvil. Camioneta  
Automóvil. Camioneta

FOR: PARA:	MODEL MODELO			PAG.		PAG.
ABARTH ®	500	2008-	FI-16P1	155	FI-16P1	155
	GRANDE PUNTO	2007-2010			FI-16P1	155
	PUNTO	2012-				
	PUNTO EVO	2010-2012				
	VARIOUS MODELS	-	FI-16C3	354	FI-16C3	354
ABT ®	GOLF 3	1991-	AU-AH	155	AU-AH	155
			AU-AHP	155	AU-AHP	155
			VO-2	155	VO-2	155
			VO-2P	155	VO-2P	155
ACM ®	10.1 ENDURO	-19-	NE-15I	155	RO-15	155
	10.4 ENDURO	-19-	NE-15IP	155		
	OFF 4WD	-19-				
ACURA (HONDA) ®	CL	1995-1998	HOND-16D	156	HOND-16D	156
			HOND-16DP	156	HOND-16DP	156
	INTEGRA	-1989	HOND-10	155	HOND-10	155
	LEGEND	1989-1991	HOND-10P	155	HOND-10P	155
	MODELOS	1986-1988				
	INTEGRA	1990-	HOND-15	156	HOND-15	156
	VIGOR	1992-	HOND-15P	156	HOND-15P	156
	INTEGRA	1990-2000	HOND-16DP	156	HOND-16DP	156
	TL	1995-1998				
	LEGEND	1990-1991	HOND-37DP		HOND-37DP	
	LEGEND	1991-	HOND-17P	156	HOND-17P	156
	NSX	1991-1997	HOND-16D	156	HOND-16D	156
			HOND-16DP	156	HOND-16DP	156
			HOND-16DP1	156	HOND-16DP1	156
	SLX	1996-1999	GM-5	155	GM-5	155
			GM-5P	155	GM-5P	155
	ACURA (HONDA) (USA) ®	TL	2009-2014	KRCHOND-31	360	KRCHOND-31
TSX		2009-2010				
TSX		2011-2014				
AIXAM ®	500-4	-	SIX-3P2	156	SIX-3P2	156
	A.721	2004-2009				
	500-4	-19-	SIX-3P	156	SIX-3P	156
			SIX-3P1	156	SIX-3P1	156
	A.741	2004-2009	SIX-3P1	156	SIX-3P1	156
	A.751	2004-2009	SIX-3P2	156	SIX-3P2	156
	CITY	2008-				
	COUPE	2008-	SIX-3P	156	SIX-3P	156
			SIX-3P1	156	SIX-3P1	156
	CROSSLINE	2007-	SIX-3P1	156	SIX-3P1	156
	CROSSOVER	2011-	SIX-3P2	156	SIX-3P2	156
	GTO	2011-				
	ROADLINE	2009-2010	SIX-3P	156	SIX-3P	156
			SIX-3P1	156	SIX-3P1	156
SCOUTY	2005-2012	SIX-3P1	156	SIX-3P1	156	
ALFA ROMEO ®	10 AR 6	-19-	FI-12	158	FI-12	158
	13 AR 6	-19-	FI-12P	158	FI-12P	158
			FI-12P3	158	FI-12P3	158
			FI-3D	158	FI-3D	158
			FI-3DP3	158	FI-3DP3	158
			FI-6I	158	FI-6I	158
			FI-6IP4	157	FI-6IP4	157
	30 AR 8	-1986	AF-7I	156	IMS-3	159

FOR: PARA:	MODEL MODELO			PAG.		PAG.
ALFA ROMEO ®	35 AR 8	-1986	AF-7IP	156	IMS-3P	159
	40 AR 8	-1986	FI-9I	158	IMS-5	159
			FI-9IP	158	IMS-5P	159
	30 AR 8	1986-	FI-2D	158	FI-2D	158
	35 AR 8	1986-	FI-2DP3	158	FI-2DP3	158
	40 AR 8	1986-	FI-3D	158	FI-3D	158
			FI-3DP1	158	FI-3DP1	158
			FI-6I	158	FI-6I	158
			FI-6IP1	158	FI-6IP1	158
	75 MILANO	1985-	AF-13	157	AF-13	157
			AF-13P	157	AF-13P	157
	75 TD	1987-	FI-3D	158	FI-3D	158
			FI-3DP4	158	FI-3DP4	158
	155 6V	1992-1995	FI-13	158	FI-13	158
155 T.S.	1992-1995	FI-13P	158	FI-13P	158	
155	1992-1995	FI-14P	159	FI-14P	159	
164 V6	1987-1995	AF-14	157	AF-14	157	
164	1987-1995	AF-14P	157	AF-14P	157	
		FI-6I	158	FI-6I	158	
		FI-6IP4	157	FI-6IP4	157	
145	1994-	FI-13	158	FI-13	158	
		FI-13P	158	FI-13P	158	
147	2000-2009			FI-16P1	159	
156	2001-2007					
156 SPORT WAGON	2001-2007					
166	2004-2007					
GIULIETTA	2010-					
MITO	2008-2019					
1750	-19-	AF-7I	156	AF-5D	156	
GIULIA 1600	-19-	AF-7IP	156	AF-5I	156	
		NE-25	159	AF-6D	156	
		AF-6I	156			
2000 BERLINA	-19-	AF-7I	156	AF-5D	156	
A 11 D	-19-	AF-7IP	156	AF-5I	156	
A 12 D	-19-			AF-6D	156	
F 11 D	-19-			AF-6I	156	
F 12 D	-19-					
GIULIA DIES.	-19-					
2000 COUPE	-19-	SIP-3	159	AF-5D	156	
2000 SPIDER	-19-			AF-5I	156	
				AF-6D	156	
				AF-6I	156	
33	1983-1986	AF-14	157	AF-14	157	
		AF-14P	157	AF-14P	157	
		FI-6I	158	FI-6I	158	
		FI-6IP4	157	FI-6IP4	157	
33	1986-1990	FI-3D	158	FI-3D	158	
		FI-6I	158	FI-6I	158	
		FI-3DP4	158	FI-3DP4	158	
33	1990-	AF-14	157	AF-14	157	
75	1990-1991	AF-14P	157	AF-14P	157	
90	1984-1985	FI-6I	158	FI-6I	158	
		FI-6IP4	157	FI-6IP4	157	
90	1985-	AF-13	157	AF-13	157	
		AF-13P	157	AF-13P	157	
A 11	-19-	BH-8	157	AF-5D	156	
A 12	-19-			AF-5I	156	
F 11	-19-			AF-6D	156	
F 12	-19-			AF-6I	156	
A 20	-19-	BH-1	157	RO-7D		
A 38	-19-	BH-1P	157			

FOR: PARA:	MODEL MODELO			PAG.		PAG.
ALFA ROMEO ®	ALFA 6	1984-	FI-6I	158	AF-10	157
			FI-6IP4	157	AF-11	157
					AF-12	157
			IMS-3	159	IMS-3	159
			IMS-5	159	IMS-5P	159
	ALFASUD	-19-	AF-7I	156	AF-5D	156
			FAB-1	157		
			AF-7IP	156	AF-5I	156
			FI-6I	158	AF-6D	156
			FI-6IP4	157	AF-6I	156
			FI-9I	158		
			FI-9IP	158		
			SIP-3	159		
	ALFETTA	1978-1982	AF-7I	156	AF-10	157
		IMS-5	159	IMS-5	159	
GIULIETTA	1979-1981	AF-7IP	156	AF-11	157	
		IMS-5P	159	IMS-5P	159	
				AF-12	157	
ALFETTA	1982-1984	FI-6I	158	AF-10	157	
		AF-5D	156	AF-5D	156	
		FI-6IP4	157	AF-11	157	
		IMS-5	159	IMS-5	159	
				AF-12	157	
ALFETTA	1984-	FI-6I	158	AF-10	157	
		FI-6IP4	157	AF-11	157	
				AF-12	157	
				FI-6I	158	
				FI-6IP4	157	
ALFETTA1.6 1	-19-	AF-7I	156	AF-5D	156	
ALFETTA1.8 1	-19-	AF-7IP	156	AF-5I	156	
				AF-6D	156	
				AF-6I	156	
ALFETTA1.6 2	-19-	AF-7I	156	AF-10	157	
		AF-5D	156	AF-5D	156	
ALFETTA1.6 G	-19-	AF-7IP	156	AF-11	157	
		FAB-1	157	FAB-1	157	
				AF-12	157	
ALFETTA1.8 2	-19-					
ALFETTA1.8 G	-19-					
ALFETTA2.0 G	-19-					
ARNA 1.2 L	-19-	FI-6I	158	DAT-6	157	
ARNA 1.2 LS	-19-	FI-6IP4	157	DAT-6P	157	
ARNA 1.3 TI	-19-					
DUETTO	-19-	FI-6I	158	AF-5D	156	
		FI-6IP4	157	AF-5I	156	
				AF-6D	156	
				AF-6I	156	
GIULIA 1300	-19-	AF-7I	156	AF-5D	156	
		AF-7IP	156	AF-5I	156	
		BH-8	157	AF-6D	156	
		NE-25	159	AF-6I	156	
GIULIETTA	1981-	FI-6I	158	GIOB-3P		
		FI-6IP4	157			
		IMS-3	159			
		IMS-3P	159			
		IMS-5	159			
		IMS-5P	159			
GTV 2.0	1982-1995	FI-6I	158	GIOB-3P		
		AF-5D	156			

FOR: PARA:	MODEL MODELO			PAG.		PAG.
ALFA ROMEO ®	GTV 2.0 6V	1984-1995	FI-6IP4	157		
			IMS-3	159		
	GTV 2.5	1982-1995	IMS-3P	159		
	GTV 2.5 6V	1984-1995	IMS-5	159		
			IMS-5P	159		
	MONTREAL	-19-	AF-7I	156	IMS-3	159
			AF-7IP	156	IMS-3P	159
					IMS-5	159
					IMS-5P	159
	SPIDER	1970-1989	AF-7I	156	AF-5D	156
			AF-7IP	156	AF-5I	156
			FI-6I	158	AF-6D	156
			FI-6IP4	157	AF-6I	156
			SIP-3	159		
SPIDER	1990-1991	AF-14	157	AF-5D	156	
		AF-14P	157	AF-5I	156	
				AF-6D	156	
				AF-6I	156	
SPIDER	1991-1995	AF-13	157	AF-13	157	
		AF-13P	157	AF-13P	157	
SPIDER 1300	-19-	AF-7I	156	AF-5D	156	
		AF-7IP	156	AF-5I	156	
		BH-8	157	AF-6D	156	
				AF-6I	156	
SPRINT	-19-	AF-7I	156	AF-5D	156	
		FAB-1	157	FAB-1	157	
		AF-7IP	156	AF-5I		

Automóvil. Camioneta  
Automobila. Kamioneta  
Voiture. Camionnette

Auto. Kleintransporter  
Automóvil. Camioneta  
Automóvil. Camioneta

FOR: PARA:	MODEL MODELO	CCCCC	PAG.	PAG.
<b>AMERICAN MOTORS</b> ®	ENCORE	1986-1988	NE-19P	160
	CHEROKEE	-1990	BAS-1I	159
	COMANCHE	-1990	GM-9	160
	W.BASE	-1990	GM-9P	160
	W.ISLANDER	-1990	GM-J	160
	W.LAREDO	-1990	GM-JP	160
	W.SAHARA	-1990		
	W.TEXAS	-1990		
	WAGONEER	-1990		
	CHEROKEE	1991-1992	CHR-9	160
	COMANCHE	1991-1992	CHR-9P	160
	MJ COMANCHE	1993-	CHR-10	160
	XJ CHEROKEE	1993-	CHR-10P	160
	YJ WRANGLER	1993-		
	ZJ G.CHEROKEE	1993-		
	VARIOUS MODELS	1953-1969	BS-1I	159
	VARIOUS MODELS	1970-1985	BAS-1I	159
	VARIOUS MODELS	1985-1988	AMM-1	159
	VARIOUS MODELS	1985-1990	AMM-2	159
	VARIOUS MODELS	-	CHR-14	160
			CHR-14P	160
			BS-2	159
			BS-5	159
			CHR-16	160
			NE-19P1	160
			NE-20P	161
			NE-20P1	161
			NE-20P2	161
			NE-20P3	161
			NE-22P1	161
			NE-22P2	161
			NE-36	161
			NE-36P	161
			NE-36P1	161
			NE-39P	161
	WAGONEER	1991-1992	CHR-9	160
			CHR-9P	160
			GM-9	160
			GM-9P	160
			GM-J	160
			GM-JP	160

<b>ARO DACIA</b> ®	203	-19-	BH-1	161	HU-1	162
			BH-1P	161		
	240	1982-1985	BH-1	161	RO-15	162
			BH-1P	161		
	240	1985-	NE-15I	162	RO-15	162
	241	1985-	NE-15IPI	162		
	242	1985-				
	243	1985-				
	244	1985-				
	ISCHIA 10.1	1985-				
	ISCHIA 10.4	1985-				
	SUPER ISCHIA	1985-				

<b>ASTON MARTIN</b> ®	LAGONDA	-19-	FO-E-TC	162	FO-E-TC	162
			IN-1	162	IN-1	162
	LAGONDA LIM.	-19-	FO-E-TCP	162	FO-E-TCP	162
			UN-FP		UN-FP	
	V8 SALOON	-19-	FO-FR	162	IN-1	162

FOR: PARA:	MODEL MODELO	CCCCC	PAG.	PAG.
<b>ASTON MARTIN</b> ®			UN-FS	163
	V8 VANTAGE	-19-	FO-FRP	162
			UN-FT	163
	V8 VANTAGE Z	-19-	OP-WHP	162
	V8 VOLANTE	-19-	OP-WYP	162
	V8 VOLANTE C	-19-		
			UN-FS	163
			UN-FT	163
	VARIOUS MODELS	-19-	FO-TX	162
			FO-TXP	162
			OP-WHC1	354
			WAS-2P	163

<b>AUDI</b> ®	50 GL	1974-	VO-VB	164	VO-VB	164
			AU-W	164	AU-W	164
	50 LS	1974-	VO-VBP	164	VO-VBP	164
	80 GLS	1979-	VO-VB	164	VO-VB	164
			AU-W	164		
			BL-1D	164	BL-1D	164
	80 GT	1979-	VO-VBP	164	VO-VBP	164
	100 GLS	1979-	NE-1	164	AU-W	164
	100 L	1979-	NE-1P	164		
	100	1979-				
	100 L	1973-1977	AU-W	164		
	100 LS	1973-1977				
	100	1973-1977				
	60	-19-				
	100	1978-1982	AU-1	163	AU-1	163
	200	1978-1982	AU-HV	163	AU-HV	163
	4000	1978-1982	AU-HVP	163	AU-HVP	163
	5000	1978-1982	VO-VB	164	VO-VB	164
	80	1978-1982	VO-VBP	164	VO-VBP	164
	100	1985-	AU-AH	163	AU-AH	163
	200	1985-	AU-AHP	163	AU-AHP	163
	4000	1985-	AU-AN	163	AU-AN	163
	5000	1985-	AU-ANP	163	AU-ANP	163
	80	1985-	VO-2	164	VO-2	164
	90	1985-	VO-2P	164	VO-2P	164
	CABRIO	1985-1995				
	COUPE	1985-1995				
	QUATTRO	1985-				
	V8	1985-				
	80	1983-1984	AU-1	163	AU-1	163
			AU-HV	163	AU-HV	163
			AU-HVP1	163	AU-HVP1	163
			VO-HV	164	VO-HV	164
			VO-VB	164	VO-VB	164
			VO-VBP	164	VO-VBP	164
	80	1984-1985	AU-AH	163	AU-AH	163
	QUATTRO	1984-1985	AU-AHP1	163	AU-AHP1	163
			AU-AN	163	AU-AN	163
			AU-ANP	163	AU-ANP	163
			VO-2	164	VO-2	164
			VO-2P	164	VO-2P	164
	A3	1997-2003	KRCHU-HAA	360	KRCHU-HAA	360
	A3	2003-2012				
	A4	1999-2001				
	A6	1998-2004				
	A8	1997-2003				
	Q3	2010-2019				
	S1	2010-2019				
	TT	1999-2002				

FOR: PARA:	MODEL MODELO	CCCCC	PAG.	PAG.
<b>AUDI</b> ®	TT	2002-2005		
	TT	2002-2006		
	TT	2007-2013		
	COUPE GT	1982-1984	AU-1	163
	QUATTRO	1982-1984	AU-HV	163
			AU-HVP	163
			VO-HV	164
			VO-VB	164
			VO-VBP	164
	FOX	1973-1977	VO-HV	164
			VO-HVP	164
	VARIOUS MODELS	-	AU-C	163
			HU-NAAC2	354
			SE-AN	164
			VO-HVP1	164
			HU-HAAC1	354
			HU-HAAC2	354
			HU-HAAC3	354

<b>AUDI (USA)</b> ®	A3	2005-2013	KRCHU-HAA	360	KRCHU-HAA	360
	A4	1997-2005				
	A4	1998-2002				
	A6	1997-2000				
	A6	1998-2004				
	A6	2001-2005				
	A8	1997-2003				
	A8	1997-2005				
	ALLROAD	2001-2005				
	Q3	2015-2019				
	S4	2000-2005				
	TT	2003-2006				
	TT	2007-2013				

<b>AUSTIN</b> ®	SHERPA 185	-19-	LF-BL	164	UN-1FS	165
	SHERPA 230	-19-	LF-RO	164	UN-FT	165
	SHERPA 255	-19-	LF-ROP	164		

<b>AUTOBIANCHI</b> ®	A111	-19-	AF-7I	165	IMS-3	166
			AF-7IP	165	IMS-3P	166
			AF-8DP	165	IMS-5	166
			AF-8I	165	IMS-5P	166
			AF-8IP	165		
			AF-9D	165		
			AF-9DP	165		
			AF-9I	165		
			AF-9IP	165		
	A111	1968-1972	AF-8D	165		
	A112	1971-1977	AF-7I	165	IMS-3	166
			AF-7IP	165	IMS-3P	166
			FI-9I	166	IMS-5	166
			FI-9IP	166	IMS-5P	166
			SIP-3	166		
	A112	1978-1981	AF-7I	165	IMS-3	166
			AF-5D	165	AF-5D	165
			AF-7IP	165	IMS-3P	166
			FO-FR	166	IMS-5	166
			FO-FRP	166	IMS-5P	166
	A112	1981-1984	AF-7I	165	IMS-3	166
			AF-5D	165	AF-5D	165
			AF-7IP	165	IMS-3P	166
			FI-8I	166	IMS-5	166

FOR: PARA:	MODEL MODELO	CCCCC	PAG.	PAG.
<b>AUTOBIANCHI</b> ®			FI-8IP	166
			FI-9I	166
			FI-9IP	166
	A112	1984-1986	FI-3D	165
			FAB-1	165
			FI-3DP3	166
			FI-6I	166
			FI-6IP3	166
			IMS-3	166
			IMS-3P	166
			IMS-5	166
			IMS-5P	166
	A112 (1.SER)	1969-1971	AF-7I	165
			AF-7IP	165
			AF-8D	165
			AF-8DP	165
			AF-8IP	165
			AF-9D	165
			AF-9DP	165
			AF-9I	165
			AF-9IP	165
			FO-FR	166
			FO-FRP	166
	BIANCHINA	-19-	FEM-1D	165
			FEM-1I	165
			FEM-2D	165
			FEM-2I	165
	PRIMULA	-19-	AF-7I	165
			AF-7IP	165
			FEM-1D	165
			FEM-1I	165
			FEM-2D	165
			FEM-2I	165
	VARIOUS MODELS	-	AF-2D	165
			AF-2I	165
			CL-7P	165
			FI-6IP4	165
	VARIOUS MODELS	1984-1985	FI-6IP2	166
	Y10	1986-	FI-1	165
			FI-1I	166
			FI-1IP	166
			FI-1P	165
			FI-1P8	165



Automóvil. Camioneta  
Automobila. Kamioneta  
Voiture. Camionnette

Auto. Kleintransporter  
Automóvil. Camioneta  
Automóvil. Camioneta

FOR: PARA:	MODEL MODELO			PAG.		PAG.
---------------	-----------------	--	--	------	--	------

<b>BERTONE</b> ®	FREECLIMBER	-19-	DAI-1P	167	DAI-1P	167
	SL-CABRIO	-19-	MIT-12	167	MIT-12	167
			MIT-7	167	MIT-7	167
			MIT-7P	167	MIT-7P	167

<b>BMA</b> ®	AMICA 250	-19-	AF-9D	167	UN-MRN	168
	AMICA 360 D	-19-	AF-9DP	168		
	AMICA 50-125	-19-	AF-9I	167		
			AF-9IP	168		
		FEM-1I	168			

<b>BMW</b> ®	524 TD	1984-1986	BM-2	168	BM-2	168
	SERIE 7	1984-1986	BM-2P	168	BM-2P	168
			BM-HB	169	BM-HB	169
			BM-HBP	169	BM-HBP	169
	1502	1968-1976	BM-W	169	BM-B	168
	1600	1968-1976			HU-SX	169
	1602	1968-1976				
	1800	1968-1976				
	1802	1968-1976				
	2000	1968-1976				
	2002	1968-1976				
	2000 TOURING	1968-	BM-W	169	BM-W	169
	2002 TOURING	1979-	BM-W	169	BM-W	169
	2500	1968-	BM-1P	168	BM-1P	168
	2800	1970-1975	BM-1P	168	BM-1P	168
	3000	1970-1975				
	3800	1970-1975				
	BAVARIA	1970-1975				
	SERIE 3	1975-1984	BM-3	168	BM-3	168
	SERIE 5	1975-1984	BM-3P	168	BM-3P	168
	SERIE 6	1975-1984	BM-HB	169	BM-HB	169
	SERIE 7	1975-1984	BM-HBP	169	BM-HBP	169
		BM-NB	169	BM-NB	169	
		BM-NBP	169	BM-NBP	169	
SERIE 3	1987-1990	BM-2	168	BM-2	168	
		BM-2P	168	BM-2P	168	
		BM-NB	169	BM-NB	169	
		BM-NBP	169	BM-NBP	169	
SERIE 3	1990-1995	BM-4	168	BM-4	168	
SERIE 5	1988-1995	BM-5P	168	BM-5P	168	
SERIE 7	1988-1995					
SERIE 8	1988-1995					

<b>BMW</b> ®	VARIOUS MODELS	-	BM-6P	169	BM-6P	169
			BM-6PIC1	169	BM-6PIC1	169

<b>BMW (USA)</b> ®	VARIOUS MODELS	-	BM-6P	169	BM-6P	169
			BM-6PIC1	169	BM-6PIC1	169

<b>BRITISH LEYLAND</b> ®	VARIOUS MODELS	-	STR-3	169	STR-3	169
					UN-2	169

<b>BUICK</b> ®	ALLURE	2005-2009	KRCGM-37	360	KRCGM-37	360
	ENCLAVE	2008-2016				
	LUCERNE	2006-2011				
	NEW LACROSSE	2005-2006				
	NEW LACROSSE	2007-2008				
	ALLURE	2010-2012	KRCOP-11	360	KRCOP-11	360
	ENCORE	2014-2015				
	NEW LACROSSE	2010-2015				

FOR: PARA:	MODEL MODELO			PAG.		PAG.
---------------	-----------------	--	--	------	--	------

<b>BUICK</b> ®	REGAL	2011-2015				
	VERANO	2012-2015				
	LESABRE	2001-2005	KRCGM-28	360	KRCGM-28	360
	RAINIER	2004-2007				
	RENDEZVOUS	2002-2007				
	TERRAZA	2005-2005	KRCGM-27	360	KRCGM-27	360
	TERRAZA	2005-2006				
	VARIOUS MODELS	2009-2019	OP-11C1	354	OP-11C1	354

<b>CADILLAC</b> ®	CTS	2008-2013	KRCGM-37	360	KRCGM-37	360
	DTS	2006-2007				
	DTS	2008-2011				
	ESCALADE	2007-2013				
	DEVILLE	2001-2005	KRCGM-28	360	KRCGM-28	360
	SEVILLE	2001-2004				
	STS	2001-2005				
	SRX	2010-2014	OP-11C1	354	OP-11C1	354

<b>CARBODIES</b> ®	FAIRWAY FX4S	-19-	LF-RO	169	IN-4	169
			LF-ROP	169	IN-5	169
			UN-FS	169		

<b>CHATENET</b> ®	BAROODER	2001-2010	SIX-3P	169	SIX-3P	169
	CH26	2007-				
	CH28	2012-				
	CH30	2010-				
	CH32	2012-				
	MEDIA	2000-2009				
	SPEEDINO	2006-2010				
	STELLA	-19-				

<b>CHEVROLET (KR)</b> ®	OPTRA	2014-2017	DAE-3DP2	170	DAE-3DP2	170
-------------------------	-------	-----------	----------	-----	----------	-----

<b>CHEVROLET</b> ®	AVEO	2011-	KRCOP-11	360	KRCOP-11	360
	CRUZE	2008-2014				
	ORLANDO	2011-2015				
	SPARK	2015-				
	CAPTIVA	2006-2011	KRCDAE-4	360	KRCDAE-4	360
	VARIOUS MODELS	-	DAT-16	170	DAT-16	170
			OP-CC	170	OP-CC	170
			OP-NA	170	OP-NA	170
			OP-NB	170	OP-NB	170
			OP-WHC1	354	OP-WHC1	354
	VARIOUS MODELS	2009-2020	OP-11C1	354	OP-11C1	354
	VARIOUS MODELS	-2020	DAE-5P	170	DAE-5P	170

<b>CHEVROLET (USA)</b> ®	AVALANCHE	2007-2013	KRCGM-37	360	KRCGM-37	360
	COBALT	2006-2011				
	EQUINOX	2007-2009				
	EXPRESS	2008-2014				
	HHR	2006-2011				
	IMPALA	2006-2013				
	MALIBU	2004-2005				
	MALIBU	2004-2007				
	MONTE CARLO	2006-2007				
	SILVERADO	2007-2013				
	SUBURBAN	2007-2014				
	TAHOE	2007-2014				
	TRAILBLAZER	2002-2009				
	TRAVERSE	2009-2016				
	CAMARO	2010-2016	KRCOP-11	361	KRCOP-11	361

FOR: PARA:	MODEL MODELO			PAG.		PAG.
---------------	-----------------	--	--	------	--	------

<b>CHEVROLET (USA)</b> ®	COLORADO	2015-2016				
	CRUZE	2011-2015				
	EQUINOX	2010-2015				
	EXPRESS	2015-2016				
	IMPALA	2014-2014				
	MALIBU	2013-2016				
	SILVERADO	2014-2016				
	SONIC	2010-2016				
	SUBURBAN	2015-2016				
	TAHOE	2015-2016				
	CAPTIVA SPORT	2012-2015	KRCDAE-4	360	KRCDAE-4	360
	COLORADO	2004-2012	KRCISU-3D	361	KRCISU-3D	361
	UPLANDER	2005-2009	KRCGM-27	360	KRCGM-27	360
			KRCGM-28	360	KRCGM-28	360
	VENTURE	1999-2000	KRCGM-27	360	KRCGM-27	360
VENTURE	2001-2005					

<b>CHRYSLER</b> ®	024	1987-	CHR-8	170	CHR-8	170
			CHR-8P	170	CHR-8P	170
	5.TH AVENUE	-19-	CHR-8	170	CHR-8	170
LEBARON	1989-	CHR-8P	170	CHR-8P	170	

<b>CHRYSLER</b> ®	NEW YORKER	-19-				
	ARROW	-19-	MIT-1I	171	MIT-1I	171
	PICK UP	-19-	MIT-1IP	171	MIT-1IP	171
	CHALLENGER	-19-	MIT-2I	171	MIT-2I	171
	CONQUEST	-19-	MIT-2IP	171	MIT-2IP	171
	RAIDER	-19-				
	SAPORO	-19-				
	COLT	1993-	MIT-8D	172	MIT-8D	172
	VISTA	1993-	MIT-8DP	172	MIT-8DP	172
	CONCORDE	1993-	CHR-10	170	CHR-10	170

<b>CHRYSLER</b> ®	FULL SIZE V.	1993-	CHR-10P	171	CHR-10P	171
	IMPERIAL	1993-				
	NEW YORKER	1993-				

<b>CHRYSLER</b> ®	PICK UP	1993-				
	TOWN & CO.	1993-				
	VANS	-19-				
	CRICKET	-19-	LF-SL	171	LF-SL	171
			LF-SLP	171	LF-SLP	171
	D 50	-19-	MIT-1I	171	MIT-1I	171
			MIT-1IP	171	MIT-1IP	171

<b>CHRYSLER</b> ®	FULL SIZE V.	-19-	CHR-8	170	CHR-8	170
			CHR-8P	170	CHR-8P	170
	GR. VOYAGER	1996-1997	CHR-14	171	CHR-14	171
	STRATUS	1995-	CHR-14P	171	CHR-14P	171
	VIPER	1995-	CHR-15	171	CHR-15	171
	VISION	1995-	CHR-15P	171	CHR-15P	171
	VOYAGER	1995-				
	LEBARON VAN.	-19-	CHR-7	170	CHR-7	170
	MOD. USA	1980-1986	CHR-7P	170	CHR-7P	170

<b>CHRYSLER</b> ®	OMNI-HORIZON	-19-				
	RELIANT	1989-				
	TC3-ARIES	-19-				
	MOD. USA	1967-1979	CHR-7	170	CHR-7	170
			CHR-7P	170	CHR-7P	170
	MOD. USA	1990-1992				
	PT CRUISER	2001-2005	KRCCHR-15	361	KRCCHR-15	361

FOR: PARA:	MODEL MODELO			PAG.		PAG.
---------------	-----------------	--	--	------	--	------

<b>CHRYSLER</b> ®	VARIOUS MODELS	-	BAS-3	172	BAS-3	172
			CHR-1	170	CHR-1	170
			CHR-14	171	CHR-14	171
			CHR-14P	171	CHR-14P	171
			CHR-2	170	CHR-2	170
			CHR-4D	170	CHR-4D	170
			CHR-4I	170	CHR-4I	170
			CHR-16		CHR-16	
			CL-7P	171	CL-7P	171
		YPSILON	2011-	FI-16P1	171	FI-16P1

<b>CHRYSLER (USA)</b> ®	200	2011-2014	KRCCHR-15	361	KRCCHR-15	361
	PACIFICA	2004-2008				
	PT CRUISER	2006-2011				

Automóvil. Camioneta  
Automobila. Kamioneta  
Voiture. Camionnette

Auto. Kleintransporter  
Automóvil. Camioneta  
Automóvil. Camioneta

FOR: PARA:	MODEL MODELO			PAG.		PAG.
CITROEN ®	DISPATCH	2005-2009				
	PARTNER	2009-2016				
BX	1990-	NE-36	174	NE-36	174	
		SIX-2P2	175	SIX-2P2	175	
		SIX-1	175	SIX-1P	175	
		SIX-1P	175	SIX-2	175	
		SIX-2	175	SIX-2P	175	
		SIX-2P	175	SIX-2P2	175	
		SIX-2P2	175			
		NE-36P1	174	NE-36P1	174	
		CIT-1C1	354	CIT-1C1	354	
		CIT-1C1	354			
C1	2004-2014	CIT-1C1 354				
C2	2002-2005					
C3	2002-2005					
C3 PLURIEL	2002-2006					
C-15 D	-19-	SIX-1	175	SIX-1	175	
		AB-10I	172	AB-10I	172	
C-15 E	-19-	SIX-1P	175	SIX-1P	175	
C-25 FURGON.	-19-	FI-6I	173	FI-6I	173	
		FI-6IP3	173	FI-6IP3	173	
C4 PICASSO	2006-2013	KRCHU-HCA	361	KRCHU-HCA	361	
C4 PICASSO	2007-2010					
C5	2007-2010					
C8	2005-2009					
C8	2009-2014					
DISPATCH	2009-2014					
JUMPY	2006-2009					
JUMPY	2009-2016					
CX	1974-1985	CT-3	172	AB-5D	172	
		LAS-V	173	LAS-V	173	
		CT-3P	172	AB-5I	172	
				RO-5D	175	
				RO-5I	175	
CX	1985-	SIX-1	175	SIX-1	175	
		SIX-1P	175	SIX-1P	175	
		SIX-2	175	SIX-2	175	
		SIX-2P	175	SIX-2P	175	
		SIX-2P	175	SIX-2P	175	
D	-1974	CT-1	172	RO-5D	175	
DS	-1974	CT-1P	172	RO-5I	175	
		CT-3	172			
		CT-3P	172			
DYANE	1967-1980	CT-2	172	RO-4D	175	
		FAB-1	173	FAB-1	173	
		CT-2P	172	RO-4I	175	
		CT-2P1	172			
		CT-3	172			
DYANE	1980-	CT-3P	172			
		SIX-1	175	RO-4D	175	
		SIX-1P	175	RO-4I	175	
		SIX-2	175	SIX-2P2	175	
		SIX-2P	175			
EVASION	1994-	SIX-3P1	175	SIX-3P1	175	
JUMPI	1996-					
G	1970-	CT-3	172	AB-5D	172	
GS	1970-	CT-3P	172	RO-5D	175	
GSA	1970-	RO-5I 175				
JUMPER	1996-	FI-11P	173	FI-11P	173	
JUMPER	2002-2010	FI-16P1 173				

FOR: PARA:	MODEL MODELO			PAG.		PAG.	
CITROEN ®	LN	1976-1984 NE-4 173 VA-6 175					
	LNA	1976-1984 NE-4P1 174 VA-6P 175					
LNA	1984-	CHR-3	172	VA-6	175		
		PJ-2	174	PJ-2	174		
		CHR-3P	172	VA-6P	175		
		PJ-2P	174				
		NE-22P1	174				
		PJ-K	174				
		PJ-KP	174				
		MEHARI	1968-	CT-3	172	RO-4D	175
				CT-3P	172	RO-4I	175
				CT-4P	173		
PLUS	-19-	FI-12	173	FI-12	173		
		FI-12P	173	FI-12P	173		
		FI-12P3	173	FI-12P3	173		
		FI-3D	173	FI-3D	173		
		FI-3DP3	173	FI-3DP3	173		
SAXO	1996-	SIX-3P	175	SIX-3P	175		
		CT-3	172	RO-5D	175		
SM	1970-	LAS-V	173	LAS-V	173		
		CT-3P	172	RO-5I	175		
SYNERGIE	1994-1997	SIX-3P	175	SIX-3P	175		
		CHR-4D	172	CHR-4D	172		
VARIOUS MODELS	-	CHR-4I	172	CHR-4I	172		
		FI-16C1	354	FI-16C1	354		
		HU-HCAP	173	HU-HCAP	173		
		NE-4P	174	NE-4P	174		
		NE-4P2	174	NE-4P2	174		
		RO-1D	175	RO-1D	175		
		RO-1DS	172	RO-1DS	172		
		RO-1I	175	RO-1I	175		
		RO-1IS	172	RO-1IS	172		
		RO-2D	175	RO-2D	175		
RO-2I	175	RO-2I	175				
RO-6D	175	RO-6D	175				
RO-6I	175	RO-6I	175				
SIX-4	175	SIX-4	175				
SIX-4P	175	SIX-4P	175				
SIX-5P	175	SIX-5P	175				
NE-36P	174	NE-36P	174				
NE-39P	174	NE-39P	174				
FI-16C3	354	FI-16C3	354				
VARIOUS MODELS	2004-2018	PEU-1C1	355	PEU-1C1	355		
VISA	1979-1985	CHR-3	172	RO-4D	175		
		PJ-2	174	PJ-2	174		
		CHR-3P	172	RO-4I	175		
		NE-22P1	174	RO-5D	175		
		PJ-2P	174				
VISA	1985-	PJ-K	174				
		NE-4	173	RO-5I	175		
		PJ-KP	174	PJ-KP	174		
		NE-4P1	174				
		SIX-1	175	SIX-1	175		
SIX-1P	175	SIX-1P	175				
VISA	1985-	PJ-2P	174				
		PJ-K	174				
		PJ-KP	174				

FOR: PARA:	MODEL MODELO			PAG.		PAG.
CITROEN ®	XANTIA	1993-	SIX-3P	175	SIX-3P	175
	XM	1990-	SIX-3P	175	SIX-3P	175
	ZX	1991-1992	SIX-1	175	SIX-1	175
			SIX-1P	175	SIX-1P	175
	ZX	1992-1994	SIX-1P2	175	SIX-1P2	175
DACIA ®	DOKKER	2012-2016	DAC-4DC1	355	DAC-4DC1	355
	SANDERO	2007-2012				
	DOKKER	2012-2019	DAC-7DC1	355	DAC-7DC1	355
	SANDERO	2007-2016				
	DUSTER	2010-2013	VA-34P	176	VA-34P	176
	LOGAN	2004-2012	VA-34P1	176	VA-34P1	176
	SANDERO	2008-2012	VA-34P2	176	VA-34P2	176
	DUSTER	2012-2016	DAC-6DC1	355	DAC-6DC1	355
	SANDERO	2012-2016				
	LOGAN	2012-2016	DAC-4DC1	355	DAC-4DC1	355
			DAC-7DC1	355	DAC-7DC1	355
			DAC-4DC1	355	DAC-4DC1	355
			DAC-6DC1	355	DAC-6DC1	355
			DAC-7DC1	355	DAC-7DC1	355
	VARIOUS MODELS	-	DAC-1DP	175	DAC-1DP	175
DAC-2D			175	DAC-2D	175	
DAC-3DC1			355	DAC-3DC1	355	
DAC-4DP			176	DAC-4DP	176	
DAC-5C1			355	DAC-5C1	355	
DAC-6DP	176	DAC-6DP	176			
DAEWOO ®	DAMA	-19-	DAE-1P	176	DAE-1P	176
	LANOS	1997-	DAE-4P1	176	DAE-4P1	176
	LEGANZA	1997-2000				
	LE MANS	1973-1982	OP-6	176	OP-6	176
			OP-7	176	OP-7	176
			OP-8	176	OP-8	176
			OP-9	176	OP-9	176
			OP-BB	177	OP-BB	177
	OP-EE	177	OP-EE	177		
	OP-FF	177	OP-FF	177		
LE MANS	1983-1984	OP-D	177	OP-D	177	
		OP-DP	177	OP-DP	177	
		OP-S	177	OP-S	177	
		OP-SP	177	OP-SP	177	
		OP-AB	176	OP-AB	176	
OP-ABP	177	OP-ABP	177			
OP-BA	176	OP-BA	176			
OP-BAP	177	OP-BAP	177			
OP-J	177	OP-J	177			
OP-JP	177	OP-JP	177			
LEGANZA	1997-	DAE-4D	176	DAE-4D	176	
		DAE-4DP1	176	DAE-4DP1	176	
NUBIRA	1997-	DAE-3DP1	176	DAE-3DP1	176	
NUBIRA	1997-2000	DAE-3D	176	DAE-3D	176	
TACUMA	2000-2002	DAE-3DP1	176	DAE-3DP1	176	
RACER	-19-	DAE-2DP	176	DAE-2DP	176	
VARIOUS MODELS	-	DAE-3DP2	176	DAE-3DP2	176	
		DAE-5P	176	DAE-5P	176	
DAEWOO (USA) ®	LEGANZA	1998-2005	DAE-4P1	176	DAE-4P1	176

FOR: PARA:	MODEL MODELO			PAG.		PAG.
DAF ®	46 L	-19-	FO-TC	177	FO-TC	177
			PJ-1	177	PJ-1	177
	46 STATIONCA	-19-				
	46 SUPER L	-19-				
	66 GL	-19-				
	66 COUPE	-19-	PJ-1	177	PJ-1	177
	66 L	-19-				
	66 MARATHON	-19-				
	66 SL	-19-				
	66 STATIONCA	-19-				
95 XF	1997-	CHR-3P	177	CHR-3P	177	
VARIOUS MODELS	-	HU-SZ	177	HU-SZ	177	
DAIHATSU ®	4 WD TURBO	-19-	TOYO-K1	178		
	PIONEER 2800	-19-	TOYO-KIP	178		
	TAFT 1600 D.	-19-				
	TAFT F10	-19-				
	TAFT F20	-19-				
	TAFT F201600	-19-				
	TAFT F50	-19-				
	TAFT F55	-19-				
	APPLAUSE	1990-	DAI-1P	177	DAI-1P	177
	CHARADE	1990-				
	ROCKY	1990-				
	CHARADE	1977-1983	TOYO-K1	178	TOYO-K1	178
	CHARMANT	1983-	TOYO-KIP	178	TOYO-KIP	178
	CHARADE	1983-1989	TOYO-3	178	TOYO-3	178
			TOYO-3P	178	TOYO-3P	178
		TOYO-8	178	TOYO-8	178	
		TOYO-8P	178	TOYO-8P	178	
CUORE 850	1986-1991	TOYO-3	178	TOYO-3	178	
		TOYO-3P	178	TOYO-3P	178	
CUORE L55	1976-1998	TOYO-K1	178	TOYO-K1	178	
CUORE L60	1976-1998	TOYO-K1P	178	TOYO-K1P	178	
MIRA	1976-					
FEROZA	1988-	DAI-1P	177	DAI-1P	177	
SPORTTRACK	1991-					
SX 228	1991-					
FOURTRAK 4WD	1984-1988	TOYO-3	178	TOYO-3	178	
		TOYO-8	178	TOYO-8	178	
ROCKY	1984-1988	TOYO-3P	178	TOYO-3P	178	
		TOYO-8	178	TOYO-8	178	
		TOYO-8P	178	TOYO-8P	178	
ROCKY	1989-1990	TOYO-3	178	TOYO-3	178	
		TOYO-3P	178	TOYO-3P	178	
VARIOUS MODELS	-	DAI-2D	178	DAI-2D	178	
DAIMLER ®	DOUBLE SIX C	-1987	FO-FR	178	CENT-3D	
	LIMOUSINE	-1987	FO-FRP	178	FO-5	178
	SOVEREIGN V.	-1987	FO-TC	178	FO-TC	178
	SOVEREIGN3.4	-1987				
	SOVEREIGN4.2	-1987				
MODELOS	1990-1994	JAU-1P	178	JAU-1P	178	
DE LOREAN ®	VARIOUS MODELS	1980-1981	NE-10	179	LF-WR	178
			NE-10P	179		

Automóvil. Camioneta  
Automobila. Kamioneta  
Voiture. Camionnette

Auto. Kleintransporter  
Automóvil. Camioneta  
Automóvil. Camioneta

FOR: PARA:	MODEL MODELO			PAG.		PAG.
DELTA MOTOR ®	CRUISER	-19-	TOYO-K1	179	TOYO-K1	179
	MINI WHEEL	-19-	TOYO-KIP	179	TOYO-KIP	179
	EXPLORER	-19-	TOYO-K1	179	DAT-6	179
			TOYO-K1P	179	DAT-6P	179
DISALCAR ®	IN 32 4X4	-19-	AF-7I	179	IMS-3	180
			AF-5D	179	AF-5D	179
	IN 50 R 4X4	-19-	AF-7IP	179	IMS-3P	180
	IN 60 4X4	-19-			IMS-5	180
	IN 70 B 4X4	-19-			IMS-5P	180
	IN 70 CR 4X4	-19-				
	R 26 4x4	-19-	BH-4	180		
DODGE ®	1800	-19-	CHR-12	180	WAS-1	181
	400	1985-	CHR-7	180	CHR-7	180
			CHR-7P	180	CHR-7P	180
			CHR-12	180	CHR-12	180
	600 CARAVEL.	1985-1989	CHR-8	180	CHR-8	180
			CHR-13D	180	CHR-13D	180
	LANCER	-19-	CHR-8P	180	CHR-8P	180
	AVENGER	2008-2014	KRCCHR-15	361	KRCCHR-15	361
	CALIBER	2007-2012				
	CARAVAN	2004-2007				
	NITRO	2007-2012				
	CARAVAN	1991-1993	CHR-8	180	CHR-8	180
			CHR-8P	180	CHR-8P	180
	CARAVAN	1993-	CHR-10	180	CHR-10	180
	DAKOTA	1993-	CHR-10P	180	CHR-10P	180
	DAYTONA	1993-				
	INTREPID	1993-				
	RAMCHARGER	1993-				
	SPIRIT	1993-				
	VIPER	1993-				
	COLT	1989-1993	CHR-17	180	CHR-17	180
			MIT-12	181	MIT-12	181
	VISTA	1989-1992	MIT-12	181	MIT-12	181
		MIT-7	180	MIT-7	180	
		MIT-7P	180	MIT-7P	180	
COLT	1993-	MIT-13D	181	MIT-13D	181	
		MIT-8D	181	MIT-8D	181	
VISTA	1993-	MIT-14D	181	MIT-14D	181	
		MIT-8D	181	MIT-8D	181	
		MIT-8DP	181	MIT-8DP	181	
DAKOTA	1991-1993	CHR-8	180	CHR-8	180	
		CHR-13D	180	CHR-13D	180	
DAYTONA	1991-1993	CHR-8P	180	CHR-8P	180	
DODGE	-19-	CHR-7	180	CHR-7	180	
		CHR-7P	180	CHR-7P	180	
		CHR-8	180	CHR-8	180	
		CHR-8P	180	CHR-8P	180	
DODGE	1985-1986	CHR-7	180	CHR-7	180	
RAM 50	-19-	CHR-7P	180	CHR-7P	180	
DODGE	1986-1990	CHR-8	180	CHR-8	180	
RAM	1986-	CHR-8P	180	CHR-8P	180	
TRAIL DUSTER	1986-					
DODGE	1991-	CHR-9	180	CHR-9	180	
SPIRIT	1990-1992	CHR-9P	180	CHR-9P	180	



FOR: PARA:	MODEL MODELO			PAG.		PAG.
DODGE ®	DODGE 400	1989-	CHR-7	180		
			CHR-7P	180		
	DODGE 600	1989-	CHR-8	180		
			CHR-8P	180		
	MONACO	1990-1993	VA-10	181	VA-10	181
	NEON	1995-	CHR-9	180	CHR-9	180
			CHR-9P	180	CHR-9P	180
	RAMCHARGER	1981-1992	CHR-7	180	CHR-7	180
			CHR-7P	180	CHR-7P	180
			CHR-8	180	CHR-8	180
			CHR-8P	180	CHR-8P	180
	SHADOW ES	1991-1992	CHR-8	180	CHR-8	180
			CHR-8P	180	CHR-8P	180
	STEALTH	1991-1993	MIT-12	181	MIT-12	181
			MIT-7	180	MIT-7	180
			MIT-7P	180	MIT-7P	180
	VARIOUS MODELS	-	CHR-14	180	CHR-14	180
		CHR-14P	180	CHR-14P	180	
VIPER	1990-1992	CHR-9	180	CHR-9	180	
		CHR-9P	180	CHR-9P	180	
DS ®	DS3	2009-2016	KRCCIT-1	361	KRCCIT-1	361
	DS4	2011-2015				
EAGLE ®	D 50	-19-	MIT-11	181	MIT-11	181
	EAGLE	-19-	NE-19	182	NE-28	182
	MEDALLION	-19-	NE-19P	182	VA-10	182
	EAGLE	1989-1990	MIT-12	182	MIT-12	182
			MIT-7	181	MIT-7	181
			MIT-7P	182	MIT-7P	182
	EAGLE	1990-1992	VA-10	182	VA-10	182
	PREMIER	1990-				
	EAGLE	1993-	MIT-8D	182	MIT-8D	182
			MIT-8DP	182	MIT-8DP	182
	SUMMIT	1989-1992	CHR-17	181	CHR-17	181
			MIT-12	182	MIT-12	182
	TALON	1989-	MIT-12	182	MIT-12	182
			MIT-7	181	MIT-7	181
			MIT-7P	182	MIT-7P	182
	SUMMIT	1993-	MIT-13D	182	MIT-13D	182
			MIT-14D	182	MIT-14D	182
			MIT-8D	182	MIT-8D	182
			MIT-8DP	182	MIT-8DP	182
	VARIOUS MODELS	-	CHR-14	181	CHR-14	181
			CHR-14P	181	CHR-14P	181
	VISION	1993-1998	CHR-10	181	CHR-10	181
			CHR-10P	181	CHR-10P	181
EBRO ®	F 275	-19-	LMP-1	183	IMS-3	183
	F 350	-19-	LMP-1P	183	IMS-3P	183
			STS-2D	183	IMS-5	183
			STS-2DP	184	IMS-5P	183
	L 35	-19-	LMP-1	183	CL-2I	182
	L 35/1	-19-	LMP-1P	183	CL-3I	182
	L 60	-19-	NE-3	183	FO-OA	183
	L 80	-19-	NE-3P	183	FO-PN	183



FOR: PARA:	MODEL MODELO			PAG.		PAG.
EBRO ®			NE-3P1	183		
			NE-3P2	183		
	PATROL	1983-	DAT-6	182	DAT-6	182
			DAT-6P	183	DAT-6P	183
	TRADE 2.0	1983-	STS-2D	183	IMS-3	183
	TRADE 2.8	1983-	STS-2DP	184	IMS-3P	183
					IMS-5	183
					IMS-5P	183
	VANETTE	1983-	DAT-6	182	DAT-6	182
			DAT-6P	183	DAT-6P	183
VARIOUS MODELS	-	NE-3D	183	NE-3D	183	
FERRARI ®	208	1975-1982	NE-25	185	IMS-3	184
	308	1973-1975			IMS-3P	184
	365	1968-			IMS-5	184
	DINO 246	-19-			IMS-5P	184
	208	1982-	NE-25	185	AF-5D	184
			FAR-1D	184		
	308	1975-			AF-5I	184
			FAR-1I	184		
	328	1985-			AF-6D	184
					AF-6I	184
	208 GTS	1982-	AF-7IP1	184		
	348	1984-	FI-6I	184	FI-6I	184
			AF-5D	184	AF-5D	184
	F 40	1984-	FI-6IP	184	FI-6IP	184
	MONDIAL	1984-	FI-6IP2	184	FI-6IP2	184
	TESTA ROSSA	1984-	FI-6IP3	184	FI-6IP3	184
	400	1976-	HU-1	184	AF-5D	184
		FAR-1D	184	FAR-1D	184	
412	1976-	NE-25	185	AF-5I	184	
		FAR-1I	184			
BB 512	1976-			AF-6D	184	
				AF-6I	184	
GTO	1984-	NE-25	185	AF-6D	184	
MONDIAL 8	1982-	AF-7I	184	AF-5D	184	
		AF-7IP	184	AF-5I	184	
		AF-7IP1	184	AF-6D	184	
				AF-6I	184	
VARIOUS MODELS	-19-	FI-6IP4	184	FI-6IP4	184	
VARIOUS MODELS	2004-2011	FI-16C3	355	FI-16C3	355	
FIAT ®	126 BIS	1987-1992	FI-3D	186	IMS-3	187
	126 UP	1987-1992	FI-3DP2	186	IMS-3P	187
			FI-3DP3	186	IMS-5	187
			FI-6I	186	IMS-5P	187
			FI-6IP2	186		
	1100	1956-	FEM-1D	185	AF-4D	185
			FEM-1I	185	AF-4I	185
			FEM-2D	185	AF-5D	185
			FEM-2I	185	AF-5I	185
					AF-6D	185
					AF-6I	185
124	1966-	AF-7I	185	IMS-3	187	
		AF-7IP	185	IMS-3P	187	



FOR: PARA:	MODEL MODELO			PAG.		PAG.
FIAT ®			AF-9D	185	IMS-5	187
			AF-9DP	185	IMS-5P	187
			FEM-1D	185		
			FEM-1I	185		
			FEM-2D	185		
			FEM-2I	185		
			FO-FR	187		
			FO-FRP	187		
			SIP-2	188		
	125	-19-	AF-7I	185	IMS-3	187
			AF-7IP	185	IMS-3P	187
		AF-9D	185	IMS-5	187	
		AF-9DP	185	IMS-5P	187	
		FO-FR	187			
		FO-FRP	187			
		SIP-2	188			
		SIP-3	188			
126	-19-	AF-7I	185	IMS-3	187	
		AF-7IP	185	IMS-3P	187	
		AF-9D	185	IMS-5	187	
		AF-9DP	185	IMS-5P	187	
		FI-3D	186			
		FI-3DP2	186			
		FI-9I	186			
		FI-9IP	187			
		FO-FR	187			
		FO-FRP	187			
		SIP-3	188			
127	1973-	AF-7I	185	IMS-3	187	
		AF-5D	185	AF-5D	185	
		AF-7IP	185	IMS-3P	187	
		FIA-2	187			
		FI-8I	186	IMS-5	187	
		IMS-12	187			
		FI-8IP	186	IMS-5P	187	
		FI-9I	186			
		FI-9IP	187			
		FO-FR	187			
		FO-FRP	187			
		SIP-3	188			
127	1983-	AF-7IP1	185			
		FI-8IP1	186			
128	-19-	NE-47	188	FI-15	187	



Automóvil. Camioneta  
Automobila. Kamioneta  
Voiture. Camionnette

Auto. Kleintransporter  
Automóvil. Camioneta  
Automóvil. Camioneta

FOR: PARA:	MODEL MODELO			PAG.		PAG.
FIAT						
			FEM-1I	185	AF-5I	185
			FEM-2D	185	AF-6D	185
			FEM-2I	185	AF-6I	185
131	1973-1980		AF-7I	185	IMS-3	187
			AF-7IP	185	IMS-3P	187
			AF-8I	185	IMS-5	187
			AF-8IP	185	IMS-5P	187
			AF-9I	185		
			AF-9IP	185		
131	1981-		FI-2D	186	FI-3D	186
			FI-2DP3	186	FI-3DP2	186
			FI-3D	186	FI-6I	186
			FI-3DP2	186	FI-6IP	186
			FI-6I	186		
			FI-6IP	186		
132	1973-		AF-7I	185	IMS-3	187
			AF-7IP	185	IMS-3P	187
			FI-8I	186	IMS-5	187
			FI-8IP	186	IMS-5P	187
147	1976-		FI-8I	186	IMS-3	187
			FIA-2	187		
			FI-8IP	186	IMS-3P	187
			IMS-12	187		
			FI-8IP1	186	IMS-5	187
			IMS-3	187		
			FI-9I	186	IMS-5P	187
			IMS-3P	187		
			FI-9IP	187		
			IMS-5	187		
148	1976-		FI-8I	186	IMS-3	187
			FIA-2	187		
			FI-8IP	186	IMS-3P	187
			IMS-3	187		
			FI-8IP1	186	IMS-5	187
			IMS-3P	187		
			FI-9I	186	IMS-5P	187
			IMS-5	187		
			IMS-5P	187		
			FI-9IP	187		
1500	1967-		FEM-1D	185	AF-5D	185
			FEM-1I	185	AF-5I	185
			FEM-2D	185	AF-6D	185
			FEM-2I	185	AF-6I	185
			SIP-2	188		
1800	1967-		SIP-2	188	AF-5D	185
2100	1967-				AF-5I	185
2300	1967-				AF-6D	185
					AF-6I	185
500	1964-		AF-9D	185	AF-5D	185
			AF-9DP	185	AF-5I	185
			FEM-1D	185	AF-6D	185
			FEM-1I	185	AF-6I	185
			FEM-2D	185		
			FEM-2I	185		
			FO-FR	187		
			FO-FRP	187		
600	1955-		FEM-1D	185	AF-5D	185
			FEM-1I	185	AF-5I	185

FOR: PARA:	MODEL MODELO			PAG.		PAG.
FIAT						
			FEM-2D	185	AF-6D	185
			FEM-2I	185	AF-6I	185
850	1964-		AF-7I	185	AF-5D	185
			AF-7IP	185	AF-5I	185
			FEM-1D	185	AF-6D	185
			FEM-1I	185	AF-6I	185
			FEM-2D	185		
			FEM-2I	185		
			FO-FR	187		
			FO-FRP	187		
			NE-3	187		
			NE-3P	188		
			NE-3P2	188		
	ARGENTA	1981-	FI-2D	186	FI-2D	186
			FI-2DP3	186	FI-2DP3	186
			FI-3D	186	FI-3D	186
			FI-3DP2	186	FI-3DP2	186
	CINQUECENTO	1992-1997	FI-11	187	FI-11	187
			FI-11P	187	FI-11P	187
	COUPE	1994-1995	FI-13	187	FI-13	187
			FI-13P	187	FI-13P	187
	CROMA	1985-1995	FI-10	185	FI-11	187
			FI-10P	185	FI-11P	187
			FI-11	187		
			FI-11P	187		
	DINO	-19-	FO-FR	187	IMS-3	187
			FO-FRP	187	IMS-3P	187
			SIP-2	188	IMS-5	187
					IMS-5P	187
	DUCATO	1994-	FI-11	187	FI-11	187
			FI-11P	187	FI-11P	187
	DUNA	1987-1991	FI-1	185	FI-1	185
			FI-1P	185	FI-1P	185
	DUNA	1992-	FI-1	185	FI-1	185
			IMS-3	187		
			FI-11	187	FI-11	187
			IMS-3P	187		
			FI-11P	187	FI-11P	187
			IMS-5	187		
			FI-1P	185	FI-1P	185
	FIORINO	-19-	AF-7I	185	IMS-3	187
			AF-7IP	185	IMS-3P	187
			AF-9D	185	IMS-5	187
			AF-9DP	185	IMS-5P	187
			AF-9I	185		
			AF-9IP	185		
			FI-8I	186		
			FI-8IP	186		
			FI-9I	186		
			FI-9IP	187		
	PANDA	1980-1985	FI-7I	186	IMS-3	187
			IMS-12	187		
			FI-8I	186	IMS-3P	187
			FI-8IP	186	IMS-5	187
			FI-8IP1	186	IMS-5P	187
			FI-9I	186		

FOR: PARA:	MODEL MODELO			PAG.		PAG.
FIAT						
			FI-9IP	187		
	PANDA	1986-1991	FI-1	185	FI-1	185
			FI-1P	185	FI-1P	185
	PANDA	1992-1995	FI-1	185	FI-1	185
			FI-11	187	FI-11	187
			FI-11P	187	FI-11P	187
			FI-1P	185	FI-1P	185
	PUNTO	1993-1995	FI-13	187	FI-13	187
			FI-13P1	187	FI-13P1	187
	REGATA	1983-	FI-1	185	FI-1	185
			FI-10	185	FI-11	187
			FI-10P	185	FI-11P	187
			FI-11	187	FI-1P	185
			FI-11P	187		
			FI-1P	185		
	RITMO	1978-1983	FI-3D	186	FI-3D	186
			FAB-2	185		
			FI-3DP	186	FI-3DP	186
			FI-3D	186	FI-3D	186
			FI-3DP2	186	FI-3DP2	186
			FI-6I	186	FI-6I	186
			FI-6IP	186	FI-6IP	186
	RITMO	1984-1986	FI-1	185	FI-1	185
	STRADA	1984-1986	FI-1P	185	FI-1P	185
	SCUDO	1995-1997	SIX-3P1	188	SIX-3P1	188
	ULYSSE	1994-				
	SCUDO	2007-2009	KRCHU-HCA	361	KRCHU-HCA	361
	SCUDO	2009-2016				
	ULYSSE	2005-2009				
	ULYSSE	2009-2011				
	SPIDER EURO.	-19-	AF-7I	185	AF-5D	185
			AF-7IP	185	AF-5I	185
					AF-6D	185
					AF-6I	185
	STRADA	1979-1982	FI-7I	186	FI-7I	186
			FI-8I	186	FI-8I	186
			FI-8IP	186	FI-8IP	186
	STRADA	1982-1984	FI-3D	186	FI-3D	186
			FI-3DP	186	FI-3DP	186
			FI-6I	186	FI-6I	186
			FI-6IP	186	FI-6IP	186
			FI-13	187	FI-13	187
			FI-13P	187	FI-13P	187
			FI-14P	187	FI-14P	187
	TIPO	1988-	FI-13	187	FI-13	187
			FI-13P	187	FI-13P	187
	UNO	1983-	FI-1	185	FI-1	185
			FI-11	187	FI-11	187
			FI-11P	187	FI-11P	187
			FI-1P	185	FI-1P	185
			IMS-12	187		
			SI-2D	188		
			SI-3D	188		
	VARIOUS MODELS	-	AF-1D	185	AF-1D	185
			15-D	185	15-D	185
			15-I	185	15-I	185

FOR: PARA:	MODEL MODELO			PAG.		PAG.
FIAT						
			AF-1I	185	AF-1I	185
			AF-2D	185	AF-2D	185
			AF-2I	185	AF-2I	185
			FI-16C2		FI-16C2	
			FI-3	186	FI-3	186
			FI-3DP1	186	FI-3DP1	186
			FI-3DP4	186	FI-3DP4	186
			FI-3DP5	186	FI-3DP5	186
			NE-3D	187	NE-3D	187
			CL-7P	185	CL-7P	185
			FI-6IP4	185	FI-6IP4	185
			FI-16C1	355	FI-16C1	355
X 1/9	1972-		AF-7I	185	IMS-3	187
			AF-7IP	185	IMS-3P	187
					IMS-5	187
					IMS-5P	187
FIAT (ARGENTINA)	128	-19-	NE-4	189	NE-46	190
			NE-4P	190		
133	-19-		NE-3	189		
			NE-3P	189		
			NE-3P2	189		
147	-19-		NE-4	189		
			NE-4P	190		
600	-19-		NE-3	189		
			NE-3P	189		
			NE-3P2	189		
DUNA	1987-1991		FI-1	188	FI-1	188
			FI-1P	188	FI-1P	188
DUNA	1992-		FI-1	188	FI-1	188
			IMS-3	189	IMS-3	189
			FI-11	189	FI-11	189
			IMS-3P	189	IMS-3P	189
			FI-11P	189	FI-11P	189
			IMS-5	189	IMS-5	189
			FI-1P	188	FI-1P	188
			IMS-5P	189		
REGATTA	1983-		FI-1	188	FI-1	188
			FI-10	188	FI-11	189
			FI-10P	188	FI-11P	189
			FI-11	189	FI-1P	188
			FI-11P	189	NE-53	190
			FI-1P	188		
SPAZIO	-19-		AF-7I	188	IMS-3	189
			AF-5D	188	AF-5D	188
			AF-7IP	188	IMS-3P	189
			IMS-5	189		
			FI-8I	188	IMS-5	189
			FI-8IP	188	IMS-5P	189
			FI-9I	188		
			FI-9IP	189		
			FO-FR	189		
			FO-FRP	189		
			SIP-3	190		
TEMPRA	-19-		FI-13	189	FI-13	189
			FI-13P	189	FI-13P	18



Automóvil. Camioneta  
Automobila. Kamioneta  
Voiture. Camionnette

Auto. Kleintransporter  
Automóvil. Camioneta  
Automóvil. Camioneta

FOR: PARA:	MODEL MODELO			PAG.		PAG.
<b>FIAT (ARGENTINA) ®</b>			FI-11P	189	FI-11P	189
			FI-1P	188	FI-1P	188
			SI-2D	190	SI-2D	190
			SI-3D	190	SI-3D	190
	VARIOUS MODELS	-	NE-3D	189	NE-3D	189
<b>FIAT (BRASIL) ®</b>	ELBA	1992-	FI-1	190	FI-1	190
			IMS-12	190	IMS-12	190
	PREMIO	1992-	FI-11	190	FI-11	190
			IMS-3	190	IMS-3	190
			FI-11P	190	FI-11P	190
			IMS-3P	190	IMS-3P	190
			FI-1P	190	FI-1P	190
			IMS-5	190	IMS-5	190
	PALIO	1996-1997	FI-13P7	190	FI-13P7	190
	UNO	1983-	FI-1	190	FI-1	190
			FI-11	190	FI-11	190
			FI-11P	190	FI-11P	190
			FI-1P	190	FI-1P	190
			SI-2D	190	SI-2D	190
			SI-3D	190	SI-3D	190
<b>FIAT (TURQUIA) ® 131</b>		1973-1980	AF-7I	191	IMS-3	191
			AF-7IP	191	IMS-3P	191
			AF-8I	191	IMS-5	191
			AF-8IP	191	IMS-5P	191
			AF-9I	191		
			AF-9IP	191		
	131	1981-	FI-2D	191	FI-3D	191
			FI-2DP3	191	FI-3DP2	191
			FI-3D	191	FI-6I	191
			FI-3DP2	191	FI-6IP	191
			FI-6I	191		
			FI-6IP	191		
	SERCE	-19-	AF-7I	191	IMS-3	191
			AF-7IP	191	IMS-3P	191
			AF-9D	191	IMS-5	191
			AF-9DP	191	IMS-5P	191
			FEM-1D	191		
			FEM-1I	191		
			FEM-2D	191		
			FEM-2I	191		
			FO-FR	191		
			FO-FRP	191		
			SIP-2	192		
	TEMPRA	1989-	FI-13	191	FI-13	191
			FI-13P	191	FI-13P	191
			FI-14P	191	FI-14P	191
<b>FIAT IVECO ®</b>	131 D MAR.	1976-	AF-7I	192	IMS-3	193
			AF-7IP	192	IMS-3P	193
					IMS-5	193
					IMS-5P	193
	180	-1989	IMS-12	193		
	190	-1989				

FOR: PARA:	MODEL MODELO			PAG.		PAG.
<b>FIAT IVECO ®</b>	238	-19-	AF-7I	192	AF-5D	192
			AF-7IP	192	AF-5I	192
			AF-9D	192	AF-6D	192
			AF-9DP	192	AF-6I	192
			AF-9I	192		
			AF-9IP	192		
	900 E	1980-	FI-8I	192	AF-5D	192
			FI-8IP	192	AF-5I	192
					AF-6D	192
					AF-6I	192
	900 T	1976-	AF-7I	192	AF-5D	192
			AF-7IP	192	AF-5I	192
			AF-8D	192	AF-6D	192
			AF-8DP	192	AF-6I	192
			AF-8I	192		
			AF-8IP	192		
			AF-9D	192		
			AF-9DP	192		
			AF-9I	192		
			AF-9IP	192		
	CAMION	1999-	FI-1P8	192	FI-1P8	192
	DAILY 30	-1984	AF-7I	192	IMS-3	193
	DAILY 35	-1984	AF-7IP	192	IMS-3P	193
	DAILY 40	-1984	FI-9I	193	IMS-5	193
	DAILY 50	-1984	FI-9IP	193	IMS-5P	193
	DAILY 30	1985-1988	FI-2D	192	FI-2D	192
			FIS-1D	193		
	DAILY 35	1985-1988	FI-2DP3	192	FI-2DP3	192
	DAILY 40	1985-1988	FI-3D	192	FI-3D	192
	DAILY 50	1985-1988	FI-3DP1	192	FI-3DP1	192
			FI-6I	192	FI-6I	192
			FI-6IP1	192	FI-6IP1	192
	DAILY 30	1989-1991	FI-11	193	FI-11	193
			FIS-1D	193		
	DAILY 35	1989-1991	FI-11P	193	FI-11P	193
	DAILY 40	1989-1991				
	DAILY 45	1989-1991				
	DAILY 49	1989-1991				
	DAILY 50	1989-1991				
	DUCATO 10	-1988	FI-12	192	FI-12	192
	DUCATO 13	-1988	FI-12P1	192	FI-12P1	192
	DUCATO MAXI	-1988	FI-12P3	192	FI-12P3	192
			FI-3D	192	FI-3D	192
			FI-3DP3	192	FI-3DP3	192
			FI-6I	192	FI-6I	192
			FI-6IP3	192	FI-6IP3	192
	DUCATO 10	1989-1996	FI-3D	192	FI-3D	192
	DUCATO 14	1989-1996	FI-3DP3	192	FI-3DP3	192
	DUCATO 4x4	1989-1996	FI-6I	192	FI-6I	192
	DUCATO MAX	1989-1996	FI-6IP3	192	FI-6IP3	192
	FIORINO	-1982	AF-9D	192	IMS-3	193
			AF-9DP	192	IMS-3P	193
			AF-9I	192	IMS-5	193
			AF-9IP	192	IMS-5P	193
			FI-9I	193		
			FI-9IP	193		
	FIORINO	1983-1987	AF-7I	192	IMS-3	193

FOR: PARA:	MODEL MODELO			PAG.		PAG.
<b>FIAT IVECO ®</b>			IMS-12	193		
			AF-7IP	192	IMS-3P	193
			IMS-3	193		
			FI-8IP1	193	IMS-5	193
			IMS-3P	193		
			FI-9I	193	IMS-5P	193
			FI-9IP	193		
	FIORINO	1988-1996	FI-11	193	FI-11	193
			IMS-12	193		
	PENNY	-1991	FI-11P	193	FI-11P	193
			IMS-3	193		
			IMS-3P	193		
			IMS-5	193		
			IMS-5P	193		
	MARENGO R.	1985-1996	FI-11	193	FI-11	193
	PANDA	-1994	FI-11P	193	FI-11P	193
	UNO	-1991				
	TALENTO	-19-	FI-6I	192	FI-6I	192
			FI-6IP	192	FI-6IP	192
			CL-7P	192	CL-7P	192
	VARIOUS MODELS	-19-				
<b>FORD ®</b>	B-MAX	2012-	KRCFO-24	361	KRCFO-24	361
	C-MAX	2003-2007				
	C-MAX	2007-2010				
	C-MAX	2011-				
	ECOSPORT	2013-2018				
	FOCUS	2004-2011				
	FOCUS	2011-				
	GALAXY	2006-2014				
	KUGA	2008-2015				
	MONDEO	2011-2014				
	S MAX	2006-2010				
	S MAX	2010-2014				
	S MAX	2011-2015				
	B-MAX	2012-2018	FO-24C2	355	FO-24C2	355
	C-MAX	2003-2010				
	ECO SPORT	2012-2016				
	FOCUS	2004-2010				
	GALAXY	2006-2011				
	KUGA	2008-2012				
	S-MAX	2006-2010				
	BRONCO	2020-2022	FO-24C9	355	FO-24C9	355
	VARIOUS MODELS	2015-2020				
	CAPRI	-19-	FO-E-TC	194	FO-E-TC	194
			BL-2	193	BL-2	193
			FO-E-TCP	194	FO-E-TCP	194
			FO-TC	195	FO-TC	195
			FO-TX	195	FO-TX	195
			FO-TXP	195	FO-TXP	195
			FO-XR	195	FO-XR	195
	CARGO	-19-	LF-WR	195	LF-WR	195
			UN-FT	196		
			NE-11	195		
			NE-11P	196		
			NE-24	196		
			NE-24P	196		

FOR: PARA:	MODEL MODELO			PAG.		PAG.
<b>FORD ®</b>	CARGO	1987-1990	NE-11	195	LF-WR	195
			UN-FT	196		
			NE-11P	196		
	CARGO	1990-	NE-11	195	NE-11	195
			UN-FT	196		
			NE-11P	196	NE-11P	196
	C-MAX	2010-2019	FO-24C1	355	FO-24C1	355
	FOCUS	2011-2019	FO-24C3	355	FO-24C3	355
	GALAXY	2010-2015				
	C-MAX	2015-2019	FO-24C3	355	FO-24C3	355
	FIESTA	2008-				
	KUGA	2011-				
	MONDEO	2007-				
	PUMA	2019-				
	S-MAX	2010-				
	CONSUL	-19-	FO-E-TC	194	FO-E-TC	194
	CORTINA	-19-	FO-E-TCP	194	FO-E-TCP	194
			FO-TC	195	FO-TC	195
			FO-XR	195	FO-XR	195
	COUGAR	1998-2000	KRCFO-6	361	KRCFO-6	361
	FIESTA	1995-2008				
	FOCUS	1998-2005				
	FUSION	2002-2012				
	KA	2000-2008				
	MONDEO	1998-2007				
	PUMA	1998-2002				
	TRANSIT	1995-2006				
	TRANSIT CONNECT	2002-2013				
	ESCORT	-1986				

Automóvil. Camioneta  
Automobila. Kamioneta  
Voiture. Camionnette

Auto. Kleintransporter  
Automóvil. Camioneta  
Automóvil. Camioneta

FOR: PARA:	MODEL MODELO			PAG.		PAG.
FORD ®		FO-TX1	195	FO-TX1	195	
		FO-TX1P	195	FO-TX1P	195	
		FO-TX2	195	FO-TX2	195	
		FO-TX2P	195	FO-TX2P	195	
		FO-TXP	195	FO-TXP	195	
	FIESTA	2008-2017	FO-24C2	355	FO-24C2	355
	MONDEO	2007-2011	KRCFO-24	361	KRCFO-24	361
	GRANADA	-1986	FO-E-TC	194	FO-E-TC	194
		FO-E-TCP	194	FO-E-TCP	194	
		FO-TX	195	FO-TX	195	
		FO-TX1	195	FO-TX1	195	
		FO-TX1P	195	FO-TX1P	195	
		FO-TX2	195	FO-TX2	195	
		FO-TX2P	195	FO-TX2P	195	
		FO-TXP	195	FO-TXP	195	
		HA-1D	195			
		HA-1I	195			
	MAVERICK	1993-1995	FO-10P	194	FO-10P	194
	MONDEO	1993-1995	FO-6P	193	FO-6P	193
	SCORPIO	1990-1995				
ORION	-1986	FO-E-TC	194	FO-E-TC	194	
		BL-2	193	BL-2	193	
SIERRA	-1986	FO-E-TCP	194	FO-E-TCP	194	
		FO-TX	195	FO-TX	195	
		FO-TX1	195	FO-TX1	195	
		FO-TX1P	195	FO-TX1P	195	
		FO-TX2	195	FO-TX2	195	
		FO-TX2P	195	FO-TX2P	195	
		FO-TXP	195	FO-TXP	195	
PROBE	1993-1996	FO-9D	193	FO-9D	193	
		FO-9DP	194	FO-9DP	194	
RANGER	2011-2015	FO-24C1	355	FO-24C1	355	
		KRCFO-24	361	KRCFO-24	361	
SCORPIO	1988-1990	FO-6P	193	FO-6P	193	
SIERRA	1990-	FO-6P	193	FO-6P	193	
TAURUS	-19-	FO-E-TC	194	FO-E-TC	194	
		FO-E-TCP	194	FO-E-TCP	194	
		HA-1D	195	HA-1D	195	
		HA-1I	195	HA-1I	195	
TOURNEO CONNECT	2013-	FO-24C1	355	FO-24C1	355	
TOURNEO COURIER	2013-					
TRANSIT	2014-2016					
TRANSIT CONNECT	2013-2018					
TRANSIT CUSTOM	2013-2019					
TRANSIT 100D	-19-	FO-TC	195	FO-PRL	195	
TRANSIT F.	-1986	FO-E-TC	194	UN-FT	196	
		FO-E-TCP	194	UN-TF	196	
		FO-TX	195			
		FO-TX1	195			
		FO-TX1P	195			
		FO-TX2	195			
		FO-TX2P	195			
		FO-TXP	195			
TRANSIT F.	1986-	FO-22P	194	FO-22P	194	

FOR: PARA:	MODEL MODELO			PAG.		PAG.	
FORD ®				FO-4P	193	FO-4P	193
		VARIOUS MODELS	-	FO-43D	194	FO-43D	194
				FO-18D	194	FO-18D	194
				FO-35	194	FO-35	194
				FO-36	194	FO-36	194
				FO-8	193	FO-8	193
				FO-FK	194	FO-FK	194
				FO-FKP	194	FO-FKP	194
				FO-OL	194	FO-OL	194
				FO-OR	194	FO-OR	194
				FO-PRR	195	FO-PRR	195
				FO-SR	195	FO-SR	195
				HU-SY	195	HU-SY	195
				LF-5	195	LF-5	195
				LF-5D	195	LF-5D	195
		VARIOUS MODELS	2011-2019	FO-24C8	355	FO-24C8	355
	FORD (ARGENTINA) ®	ESCORT	-1986	FO-E-TC	196	FO-E-TC	196
				BL-2	196		
				FO-E-TCP	197	FO-E-TCP	197
				FO-TC	197	FO-TC	197
			FO-TX	197	FO-TX	197	
			FO-TX1	197	FO-TX1	197	
			FO-TX1P	197	FO-TX1P	197	
			FO-TX2	197	FO-TX2	197	
			FO-TX2P	197	FO-TX2P	197	
			FO-TXP	197	FO-TXP	197	
ESCORT		1986-1988	FO-4P	196	FO-4P	196	
SIERRA		1986-1988					
ESCORT		1988-1995	FO-6P	196	FO-6P	196	
SIERRA		1988-1990					
ESCORT VAN		-19-	FO-E-TC	196	FO-E-TC	196	
			FO-E-TCP	197	FO-E-TCP	197	
			FO-TX	197	FO-TX	197	
			FO-TXP	197	FO-TXP	197	
FALCON		-19-	FO-2	196	FO-2	196	
			FO-1	196	FO-1	196	
		GAS-1	197				
FIESTA	1995-1996	FO-6P	196	FO-6P	196		
MONDEO	1995-1996						
GALAXI	1996-	FO-17P	196	FO-17P	196		
GALAXY	-1996	FO-FHP	197	FO-FHP	197		
		VO-HV	197	VO-HV	197		
		VO-HVP	197	VO-HVP	197		
ORION	-19-	FO-ANP	196	FO-ANP	196		
PICK UP	-1993	FO-2	196	FO-2	196		
		FO-1	196	FO-1	196		
PICK UP	1993-1994	FO-15DP	196	FO-15DP	196		
		FO-3D	196	FO-3D	196		
		FO-3DP	196	FO-3DP	196		
		VO-HV	197				
		VO-HVP	197				
PICK-UP	1995-1996	FO-11D	196	FO-11D	196		
RANGER	1993-1994	FO-15DP	196	FO-15DP	196		
		FO-3D	196	FO-3D	196		

FOR: PARA:	MODEL MODELO			PAG.		PAG.	
FORD (ARGENTINA) ®				FO-3DP	196	FO-3DP	196
				VO-HVP	197		
	SIERRA	-1986	FO-E-TC	196	FO-E-TC	196	
			FO-E-TCP	197	FO-E-TCP	197	
			FO-TX	197	FO-TX	197	
			FO-TX1	197	FO-TX1	197	
			FO-TX1P	197	FO-TX1P	197	
			FO-TX2	197	FO-TX2	197	
			FO-TX2P	197	FO-TX2P	197	
			FO-TXP	197	FO-TXP	197	
	SIERRA	1990-	FO-6P	196	FO-6P	196	
	TAURUS	-19-	FO-TX	197	FO-TX	197	
			FO-TXP	197	FO-TXP	197	
	TRANSIT	-19-	FO-4P	196	FO-4P	196	
			FO-6P	196	FO-6P	196	
	VARIOUS MODELS	-	VO-HVP1	197	VO-HVP1	197	
	FORD (AUSTRALIA) ®	CAPRI	-1978	FO-D	198	FO-TC	198
				FO-TC	198	FO-XL	198
		CAPRI	1978-	FO-1	198	FO-1	198
				FO-2	198	FO-2	198
			FO-TX	198	FO-TX	198	
			FO-TXP	198	FO-TXP	198	
EXPLORER		1996-1997	FO-15D	198	FO-15D	198	
TAURUS		1996-1997	FO-15DP	198	FO-15DP	198	
TAURUS WAGON		1996-1997					
FALCON		2002-2008	KRCFO-6	361	KRCFO-6	361	
TERRITORY		2004-2011					
FALCON		2005-2008	KRCFO-24	361	KRCFO-24	361	
FALCON		2008-2011					
TERRITORY		2009-2011					
FESTIVA		1993-1994	KI-1D	198	KI-1D	198	
			KI-1DP	198	KI-1DP	198	
FESTIVA		1994-	FO-12	198	FO-12	198	
			FO-12P	198	FO-12P	198	
LASER		1988-1990	FO-14DP	198	FO-14DP	198	
LASER		1990-1993	FO-13DP	198	FO-13DP	198	
TELSTAR	-19-	MAZ-2D	199	MAZ-2D	199		
		MAZ-2DP	199	MAZ-2DP	199		
FORD (BRASIL) ®	CORCEL	-19-	FO-3D	199	FO-3D	199	
			FO-3	199	FO-3	199	
	DEL REY	-19-	FO-3DP	199	FO-3DP	199	
			FO-3P	199	FO-3P	199	
	ESCORT	-1986	FO-E-TC	199	FO-E-TC	199	
			BL-2	199	BL-2	199	
			FO-E-TCP	199	FO-E-TCP	199	
			FO-TC	199	FO-TC	199	
			FO-TX	199	FO-TX	199	
			FO-TX1	199	FO-TX1	199	
			FO-TX1P	199	FO-TX1P	199	
			FO-TX2	199	FO-TX2	199	
			FO-TX2P	200	FO-TX2P	200	
			FO-TXP	200	FO-TXP	200	
	ESCORT	1986-1988	FO-4P	199	FO-4P	199	
	ESCORT	1988-1995	FO-6P	199	FO-6P	199	

FOR: PARA:	MODEL MODELO			PAG.		PAG.	
FORD (BRASIL) ®	ESCORT VAN	-19-	FO-E-TC	199	FO-E-TC	199	
	SIERRA	-19-	FO-E-TCP	199	FO-E-TCP	199	
	VERONA	-19-	FO-TX	199	FO-TX	199	
			FO-TXP	200	FO-TXP	200	
	PICK-UP	1995-1996	FO-3P	199	FO-3P	199	
	VARIOS	1996-	FO-17P	199	FO-17P	199	
	FORD (SOUTH AFRICA) ®	SAPPHIRE	1990-	FO-6P	200	FO-6P	200
		SIERRA	1990-				
		SIERRA	-1986	FO-E-TC	200	FO-E-TC	200
				BL-2	200	BL-2	200
			FO-E-TCP	200	FO-E-TCP	200	
			FO-TX	200	FO-TX	200	
			FO-TX1	200	FO-TX1	200	
			FO-TX1P	200	FO-TX1P	200	
			FO-TX2	200	FO-TX2	200	
			FO-TX2P	200	FO-TX2P	200	
SIERRA	1986-1988	FO-4P	200	FO-4P	200		
SIERRA	1988-1990	FO-6P	200	FO-6P	200		
FORD (USA) ®	AEROSTAR	1986-1991	FO-20D	201	FO-20D	201	
			FO-1	200	FO-1	200	
			FO-8D	201	FO-8D	201	
	AEROSTAR	1991-1996	FO-11D	201	FO-1	200	
	EXPLORER	1991-1996					
	TAURUS S.	1991-1996					
	T-BIRD S.	1991-					
	AEROSTAR	1996-1997	FO-15D	201	FO-15D	201	
	BRONCO PICK	1996-1997	FO-15DP	201	FO-15DP	201	
	EXPLORER	1996-1997					
	TAURUS	1996-1997					
	TAURUS WAGON	1996-1997					
	ASPIRE	1994-	FO-12	201	FO-12	201	
			FO-12P	201	FO-12P	201	
	BRONCO	1967-1989	FO-2	200	FO-1	200	
	CROWN	1967-1989					
	MUSTANG	1967-1998					
	T-BIRD	1967-1984					
	VICTORIA	1967-1989					
	CONCOURSE	1995-	FO-1	200	FO-1	200	
CONTOUR	1995-1997						



Automóvil. Camioneta  
Automobila. Kamioneta  
Voiture. Camionnette

Auto. Kleintransporter  
Automóvil. Camioneta  
Automóvil. Camioneta

FOR: PARA:	MODEL MODELO			PAG.		PAG.
<b>GM (CADILLAC) ®</b>					GM-H	205
					GM-HP	205
	VARIOUS MODELS	1979-	GM-6	204	GM-10	204
			GM-6P	204	GM-10P	204
			GM-A	204	GM-6	204
			GM-AP	204	GM-6P	204
					GM-A	204
					GM-AP	204
					GM-B	205
					GM-BP	205
	VARIOUS MODELS	1980-	GM-7	204	GM-11	204
			GM-7P	204	GM-11P	204
			GM-C	204	GM-D	205
			GM-CP	204	GM-DP	205
	VARIOUS MODELS	1981-	GM-8	204	GM-12	204
			GM-8P	204	GM-12P	204
			GM-E	204	GM-H	205
			GM-EP	204	GM-HP	205
	VARIOUS MODELS	1982-	GM-9	204	GM-13	204
			GM-9P	204	GM-13P	204
			GM-J	204	GM-K	205
			GM-JP	204	GM-KP	205
	VARIOUS MODELS	1983-	GM-6	204	GM-10	204
			GM-6P	204	GM-10P	204
			GM-A	204	GM-B	205
			GM-AP	204	GM-BP	205
	VARIOUS MODELS	1984-	GM-6	204	GM-10	204
	VARIOUS MODELS	1985-	GM-6P	204	GM-10P	204
			GM-7	204	GM-7	204
			GM-7P	204	GM-7P	204
			GM-A	204	GM-B	205
			GM-AP	204	GM-BP	205
			GM-C	204	GM-C	204
			GM-CP	204	GM-CP	204
<b>GM (CHEVROLET BRA.) ®</b>	CHEVAIR	-19-	OP-WHP	208	OP-WHP	208
	CHEVROLET	1982-1987	OP-WYP	208	OP-WYP	208
	COMMODORE	-19-				
	MONZA	1982-1987				
	OMEGA	-19-				
	CHEVETTE	1987-1989	OP-R	208	OP-R	208
	CHEVROLET	1987-	OP-RP	208	OP-RP	208
			OP-T	208	OP-T	208
			OP-TP	208	OP-TP	208
	CHEVROLET	1989-1990	OP-D	207	OP-D	207
	PANEMA	1989-	OP-DP	208	OP-DP	208
			OP-S	207	OP-S	207
			OP-SP	208	OP-SP	208
	CHEVROLET	1990-	SUZU-7	208	SUZU-7	208
	SPRINT 1.0	-19-	SUZU-7P	208	SUZU-7P	208
	DIPLOMATA	-19-	CHR-8	207	CHR-8	207
			CHR-8P	207	CHR-8P	207

FOR: PARA:	MODEL MODELO			PAG.		PAG.
<b>GM (CHEVROLET BRA.) ®</b>	VARIOUS MODELS	1935-1966	BAS-II	207	BAS-II	207
			BAS-ID	207	BAS-ID	207
	VARIOUS MODELS	1966-	GM-6	207	GM-6	207
			GM-6P	207	GM-6P	207
			GM-10	207	GM-10	207
			GM-10P	207	GM-10P	207
	VARIOUS MODELS	1974-	GM-A	207	GM-A	207
			GM-B	207	GM-B	207
			GM-AP	207	GM-AP	207
			GM-BP	207	GM-BP	207
			GM-7	207	GM-7	207
			GM-7P	207	GM-7P	207
			GM-C	207	GM-C	207
			GM-CP	207	GM-CP	207
			GM-D	207	GM-D	207
			GM-DP	207	GM-DP	207
			GM-8	207	GM-8	207
			GM-8P	207	GM-8P	207
			GM-12	207	GM-12	207
			GM-12P	207	GM-12P	207
			GM-E	207	GM-E	207
			GM-EP	207	GM-EP	207
			GM-H	207	GM-H	207
			GM-HP	207	GM-HP	207
			GM-9	207	GM-9	207
			GM-9P	207	GM-9P	207
	VARIOUS MODELS	1978-	GM-J	207	GM-J	207
			GM-JP	207	GM-JP	207
			GM-K	207	GM-K	207
			GM-KP	207	GM-KP	207
	VARIOUS MODELS	1976-	GM-7	207	GM-11	207
			GM-7P	207	GM-11P	207
			GM-C	207	GM-7	207
			GM-CP	207	GM-7P	207
					GM-C	207
					GM-CP	207
					GM-D	207
					GM-DP	207
	VARIOUS MODELS	1977-	GM-8	207	GM-12	207
			GM-8P	207	GM-12P	207
			GM-E	207	GM-8	207
			GM-EP	207	GM-8P	207
					GM-E	207
					GM-EP	207
					GM-H	207
					GM-HP	207
	VARIOUS MODELS	1979-	GM-6	207	GM-10	207
			GM-6P	207	GM-10P	207
			GM-A	207	GM-6	207
			GM-AP	207	GM-6P	207
					GM-A	207
					GM-AP	207
					GM-B	207

FOR: PARA:	MODEL MODELO			PAG.		PAG.
<b>GM (CHEVROLET BRA.) ®</b>					GM-BP	207
	VARIOUS MODELS	1980-	GM-7	207	GM-11	207
			GM-7P	207	GM-11P	207
			GM-C	207	GM-D	207
			GM-CP	207	GM-DP	207
			GM-8	207	GM-12	207
			GM-8P	207	GM-12P	207
			GM-E	207	GM-H	207
			GM-EP	207	GM-HP	207
			GM-9	207	GM-13	207
			GM-9P	207	GM-13P	207
			GM-J	207	GM-K	207
			GM-JP	207	GM-KP	207
			GM-6	207	GM-10	207
			GM-6P	207	GM-10P	207
			GM-A	207	GM-B	207
			GM-AP	207	GM-BP	207
			GM-6	207	GM-10	207
			GM-6P	207	GM-10P	207
			GM-7	207	GM-7	207
			GM-7P	207	GM-7P	207
			GM-A	207	GM-B	207
			GM-AP	207	GM-BP	207
			GM-C	207	GM-C	207
			GM-CP	207	GM-CP	207
<b>GM (CHEVROLET) ®</b>	ASTRO VAN	1996-1997	GM-14	205	GM-14	205
	CAVALIER	1996-1997	GM-14P	205	GM-14P	205
	LARGE BLAZER	1996-1997	GM-25	206	GM-25	206
	LARGE PICKUP	1996-1997	GM-25P	206	GM-25P	206
	MODELOS	1995-				
	S-10 BLAZER	1996-1997				
	S-10 PICKUP	1996-1997				
	VENTURE	1997-				
	BERETTA	1987-1990	GM-17P	206	GM-11	205
	CORSICA	1987-1990			GM-11P	205
					GM-D	206
					GM-DP	206
	BERETTA	1991-	GM-18P	206	GM-12	205
	CORSICA	1991-			GM-12P	205
					GM-H	206
					GM-HP	206
	CAMARO	1989-1990			GM-11	205
	CORVETTE	1989-1990			GM-11P	205
					GM-D	206
					GM-DP	206
	CAMARO	1991-			GM-12	205
	CAVALIER RS	1991-			GM-12P	205
	CORVETTE	1991-			GM-H	206
					GM-HP	206
	CAVALIER LS	1991-1992	GM-22	206		
			GM-22P	206		
	CAVALIER LS	1993-	GM-23	206		
			GM-23P	206		
	COLORADO	2004-	TOYO-15	206	TOYO-15	206

FOR: PARA:	MODEL MODELO			PAG.		PAG.
<b>GM (CHEVROLET) ®</b>					TOYO-15P	207
					TOYO-15P	207
	IMPALA	2000-2005	GM-14	205	GM-14	205
			GM-14P	205	GM-14P	205
	KODIAK 6	1997-	GM-8	205	GM-12	205
	MODELOS	1981-	GM-8P	205	GM-12P	205
	WHEELER	1997-	GM-E	206	GM-H	206
			GM-EP	206	GM-HP	206
	LUMINA	1988-1990	GM-19P	206	GM-11	205
					GM-11P	205
					GM-D	206
					GM-DP	206
	LUMINA	1991-	GM-20P	206	GM-12	205
					GM-12P	205
					GM-H	206
					GM-HP	206
	SPARK	-19-	DAE-3P2	205	DAE-3P2	205
	SPECTRUM	1985-1989	GM-2	205	GM-2	205
			GM-2P	205	GM-2P	205
	SPRINT	1985-1988	GM-1P	205	GM-1P	205
			MIT-2I	206	MIT-2I	206
	VARIOUS MODELS	-	GM-3P	205	GM-3P	205
			GM-26	206	GM-26	206
			BAS-1I	205	BAS-1I	205
			BAS-1D	205	BAS-1D	205
			GM-6	205	GM-6	205
			GM-10	205	GM-10	205
			GM-6P	205	GM-6P	205
			GM-10P	205	GM-10P	205
			GM-A	206	GM-A	206
			GM-B	206	GM-B	206
			GM-AP	206	GM-AP	206
			GM-BP	206	GM-BP	206
			GM-7	205	GM-7	205
			GM-7P	205	GM-7P	205
			GM-C	206	GM-C	206
			GM-CP	206	GM-CP	206



Automóvil. Camioneta  
Automobila. Kamioneta  
Voiture. Camionnette

Auto. Kleintransporter  
Automóvil. Camioneta  
Automóvil. Camioneta

FOR: PARA:	MODEL MODELO			PAG.		PAG.
<b>GM (CHEVROLET) ®</b>				GM-DP		206
				GM-H		206
				GM-HP		206
<b>GM (OLDS MOBILE) ®</b>	98 REGENCY	1991-		GM-12		209
	DELTA 88 RO.	1992-		GM-12P		209
	TORONADO	1991-		GM-H		210
				GM-HP		210
	ACHIEVA	1992-1993		GM-22	210	
				GM-22P	210	
				GM-23	210	
				GM-23P	210	
	ACHIEVA	1994-		GM-14	210	GM-14 210
	AURORA	1995-		GM-14P	210	GM-14P 210
				GM-25	210	GM-25 210
				GM-25P	210	GM-25P 210
	ALERO	2000-2004		GM-14	210	GM-14 210
	INTRIGUE	2000-2003		GM-14P	210	GM-14P 210
	CUTLASS	1988-1990		GM-19P	210	
	SILHOUETTE	1988-1990				
	CUTLASS SUP.	1991-		GM-20P	210	
	VARIOUS MODELS	-		BAS-II	209	BAS-II 209
				BAS-ID	209	BAS-ID 209
				GM-6	209	GM-6 209
				GM-10	209	GM-10 209
				GM-6P	209	GM-6P 209
				GM-A	210	GM-A 210
				GM-B	210	GM-B 210
				GM-AP	210	GM-AP 210
				GM-BP	210	GM-BP 210
				GM-7	209	GM-7 209
				GM-7P	209	GM-7P 209
				GM-11P	209	GM-11P 209
				GM-C	210	GM-C 210
				GM-CP	210	GM-CP 210
				GM-DP	210	GM-DP 210
				GM-8	209	GM-8 209
				GM-12	209	GM-12 209
				GM-8P	209	GM-8P 209
				GM-12P	209	GM-12P 209
				GM-E	210	GM-E 210
				GM-H	210	GM-H 210
				GM-EP	210	GM-EP 210
				GM-HP	210	GM-HP 210
				GM-9	209	GM-9 209
				GM-13	209	GM-13 209
				GM-9P	209	GM-9P 209
				GM-13P	209	GM-13P 209
				GM-J	210	GM-J 210
				GM-K	210	GM-K 210
				GM-JP	210	GM-JP 210
				GM-KP	210	GM-KP 210
	TORONADO	1989-1990		GM-11	209	
				GM-11P	209	

FOR: PARA:	MODEL MODELO			PAG.		PAG.
<b>GM (OLDS MOBILE) ®</b>				GM-D		210
				GM-DP		210
<b>GM (PONTIAC) ®</b>	BONNEVILLE	1992-		GM-12		211
	FIREBIRD	1991-		GM-12P		211
	FORMULA	1991-		GM-H		211
	GTA	1991-		GM-HP		211
	TRANS AM	1991-				
	GRAND AM	1992-1993		GM-22	211	
	SUNBIRD	1992-1993		GM-22P	211	
				GM-23	211	
				GM-23P	211	
	GRAND AM	1994-		GM-14	211	GM-14 211
				GM-14P	211	GM-14P 211
				GM-25	211	GM-25 211
				GM-25P	211	GM-25P 211
	GRAND AM	2000-2005		GM-14	211	GM-14 211
				GM-14P	211	GM-14P 211
	GRAND PRIX	1991-1994		GM-20P	211	
	LE MANS	1987-		OP-S	212	OP-S 212
				OP-SP	212	OP-SP 212
	SUNFIRE	2000-2005		GM-25	211	GM-25 211
				GM-25P	211	GM-25P 211
	TORRENT	2000-2005		GM-14	211	GM-14 211
				GM-14P	211	GM-14P 211
	TRANS SPORT	1988-1990		GM-19P	211	
	VARIOUS MODELS			BAS-II	210	BAS-II 210
				BAS-ID	210	BAS-ID 210
				GM-6	210	GM-6 210
				GM-10	211	GM-10 211
				GM-6P	210	GM-6P 210
				GM-10P	211	GM-10P 211
				GM-A	211	GM-A 211
				GM-B	211	GM-B 211
				GM-AP	211	GM-AP 211
				GM-BP	211	GM-BP 211
				GM-7	210	GM-7 210
				GM-11	211	GM-11 211
				GM-7P	210	GM-7P 210
				GM-11P	211	GM-11P 211
				GM-C	211	GM-C 211
				GM-D	211	GM-D 211
				GM-CP	211	GM-CP 211
				GM-DP	211	GM-DP 211
				GM-8	210	GM-8 210
				GM-12	211	GM-12 211
				GM-8P	210	GM-8P 210
				GM-12P	211	GM-12P 211
				GM-E	211	GM-E 211
				GM-H	211	GM-H 211
				GM-EP	211	GM-EP 211
				GM-HP	211	GM-HP 211
				GM-9	210	GM-9 210
				GM-13	211	GM-13 211
				GM-9P	210	GM-9P 210

FOR: PARA:	MODEL MODELO			PAG.		PAG.
<b>GM (PONTIAC) ®</b>				GM-13P	211	GM-13P 211
				GM-J	211	GM-J 211
				GM-K	211	GM-K 211
				GM-JP	211	GM-JP 211
				GM-KP	211	GM-KP 211
				GM-7	210	GM-11 211
				GM-7P	210	GM-11P 211
				GM-C	211	GM-7 210
				GM-CP	211	GM-7P 210
						GM-C 211
						GM-CP 211
						GM-D 211
						GM-DP 211
				GM-8	210	GM-12 211
				GM-8P	210	GM-12P 211
				GM-E	211	GM-8 210
				GM-EP	211	GM-8P 210
						GM-E 211
						GM-EP 211
						GM-H 211
						GM-HP 211
<b>GM (SATURN) ®</b>	SATURN	1990-1994		GM-21	212	GM-21 212
				GM-21P	212	GM-21P 212
<b>GM ®</b>	BLAZER	-19-		GM-14P	202	GM-14P 202
	CORSA	-19-		OP-SP	202	OP-SP 202
	PICK UP C10	-19-		GM-25P	202	GM-25P 202
	VECTRA	-19-		OP-WHP	202	OP-WHP 202
				OP-WYP	202	OP-WYP 202
<b>GMC ®</b>	ACADIA	2007-2016		KRCGM-37	362	KRCGM-37 362
	ENVOY	2002-2009				
	SAVANA	2003-2007				
	SAVANA	2008-2019				
	SIERRA	2007-2013				
	YUKON	2007-2013				
	CANYON	2004-2012		KRCISU-3D	362	KRCISU-3D 362
	CANYON	2015-2016		KRCOP-11	362	KRCOP-11 362
	SIERRA	2015-2016				
	YUKON	2015-2016				
	TILTMASTER W7	2008-2011		ISU-5		ISU-5
	VARIOUS MODELS	2015-2019		OP-11C1	355	OP-11C1 355
<b>HAMOMAG HENSCHTEL ®</b>	F 20	-19-		ME-VA	212	ME-VA 212
	F 35	-19-				
<b>HOLDEN ®</b>	APOLLO	1991-		TOYO-14		TOYO-14
	NOVA	1991-		TOYO-14P		TOYO-14P
	ASTRA	1986-		DAT-12	212	DAT-12 212
	ASTRA	1998-2004		KRCOP-S	362	KRCOP-S 362
	BARINA	1981-1990		MIT-II	213	MIT-II 213
	CAMIRA	1980-		MIT-IIP	213	MIT-IIP 213
	DROVER	1981-		TOYO-14		TOYO-14
	GEMINI	1980-1984		TOYO-14P		TOYO-14P
	JACKAROO	1980-				

FOR: PARA:	MODEL MODELO			PAG.		PAG.
<b>HOLDEN ®</b>	RODEO	1980-				
	SHUTTLE	1980-				
	BARINA	1991-1993		SUZU-10	213	SUZU-10 213
				SUZU-10P	213	SUZU-10P 213
	BARINA	1994-		OP-S	213	OP-S 213
				OP-SP	213	OP-SP 213
	BELMOND	1971-1978		GM-6	212	GM-6 212
	KINGSWOOD	1971-1978		GM-6P	212	GM-6P 212
	STATESMAN	1972-1978		GM-A	212	GM-A 212
	TORANA	1971-1972		GM-AP	213	GM-AP 213
	BELMOND	-1979		GM-42	212	GM-42 212
	CALAIS	1978-				
	COMMODORE	1978-				
	KINGSWOOD	1979-				
	STATESMAN	1978-				
	CALAIS	1993-		OP-WHP	213	OP-WHP 213
	COMMODORE	1993-				
	COMMODORE	1987-1993		OP-WHP	213	OP-WHP 213
				OP-WYP	213	OP-WYP 213
	FJ	-19-		HUD-1	213	HUD-1 213
	GEMINI	1985-		GM-2	212	GM-2 212
	SPECTRUM	1985-		GM-2P	212	GM-2P 212
	GEMINI STAT.	1981-		MIT-II	213	OP-AB 213
				MIT-IIP	213	OP-ABP 213
				TOYO-14		OP-BA 213
				TOYO-14P		OP-BAP 213
						OP-J 213
	MODELLOS	1955-1970		BAS-II	212	BAS-II 212
	TORANA	-1971		BAS-II	212	UN-FS
	VARIOUS MODELS	-19-		OP-WHC1	356	OP-WHC1 356
	VARIOUS MODELS	2003-2014		OP-11C1	355	OP-11C1 355
<b>HONDA ®</b>	ACCORD	1976-1980		HOND-1	214	HOND-1 214
				HOND-1P	214	HOND-1P 214

Automóvil. Camioneta  
Automobila. Kamioneta  
Voiture. Camionnette

Auto. Kleintransporter  
Automóvil. Camioneta  
Automóvil. Camioneta

FOR: PARA:	MODEL MODELO			PAG.		PAG.
HONDA®	CIVIC					
	CR-V					
	CR-V					
	FRV					
	JAZZ					
	JAZZ					
	JAZZ					
	ACCORD 2 LS		NE-35	215	NE-35	215
	ACCORD 2 S		NE-35P2	215	NE-35P2	215
	CIVIC					
	CONCERTO					
	ACCORD COUPE		HOND-14	214	HOND-14	214
	CIVIC		HOND-14P	214	HOND-14P	214
	ACCORD EX		HOND-16D	215	HOND-16D	215
			HOND-16DP	215	HOND-16DP	215
	CITY JAZZ		HOND-10	214	HOND-10	214
			HOND-10P	214	HOND-10P	214
	CIVIC		NE-1	215	HOND-3D	214
			HOND-14	214	HOND-14	214
			NE-1P	215		
			HOND-14P	214	HOND-14P	214
	CIVIC		HOND-1	214	HOND-1	214
			HOND-1P	214	HOND-1P	214
			HOND-2	214	HOND-2	214
			HOND-2P	214	HOND-2P	214
	CIVIC		HOND-10	214	HOND-10	214
			HOND-10P	214	HOND-10P	214
			HOND-11	214	HOND-11	214
			HOND-11P	214	HOND-11P	214
	CIVIC		HOND-12	214	HOND-12	214
			HOND-12P	214	HOND-12P	214
			HOND-13	214	HOND-13	214
			HOND-13P	214	HOND-13P	214
	CIVIC		HOND-10	214	HOND-10	214
	PRELUDE		HOND-10P	214	HOND-10P	214
	CIVIC CRX		HOND-14	214	HOND-14	214
	CIVIC SHUTLE		HOND-14P	214	HOND-14P	214
			HOND-15	215	HOND-15	215
			HOND-15P	215	HOND-15P	215
	COUPE		NE-1	215	HOND-14	214
	LIFE		NE-1P	215	HOND-14P	214
	N 360					
	TOURER					
	PASSPORT		GM-5P	214	GM-5P	214
	PRELUDE		HOND-12	214	HOND-12	214
			HOND-12P	214	HOND-12P	214
			HOND-13	214	HOND-13	214
			HOND-13P	214	HOND-13P	214
	PRELUDE		HOND-14	214	HOND-14	214
			HOND-14P	214	HOND-14P	214
			HOND-16D	215	HOND-16D	215
			HOND-16DP	215	HOND-16DP	215
HONDA (AUSTRALIA)®	ACCORD		KRCHOND-31	362	KRCHOND-31	362
HONDA (USA)®	ACCORD		KRCHOND-21	362	KRCHOND-21	362
			KRCHOND-31	362	KRCHOND-31	362

FOR: PARA:	MODEL MODELO			PAG.		PAG.
HONDA (USA)®	ACCORD		KRCHOND-31	362	KRCHOND-31	362
	ACCORD					
	ACCORD CROSSTOUR					
	CIVIC					
	CIVIC					
	CR-V					
	CR-V					
	CR-V					
	CR-V					
	CR-V					
	CR-V					
	CR-Z					
	FIT					
	FIT					
	INSIGHT					
	JAZZ					
	ODYSSEY					
	PILOT					
	RIDGELINE					
	CIVIC		KRCHOND-21	362	KRCHOND-21	362
HUMMER®	H2		RE-1D	215	RE-1D	215
	H2		KRCGM-37	362	KRCGM-37	362
	H3					
	H3		BL-2	215	BL-2	215
HYUNDAI®	ACCENT		HY-5	216	HY-5	216
	EXCEL		HY-5P	216	HY-5P	216
	CRETA		HY-11DP1	217	HY-11DP1	217
	ELANTRA					
	GENESIS COUPE					
	SANTAFE					
	SONATA					
	ELANTRA		HY-4	216	HY-4	216
	LANTRA		HY-4P	216	HY-4P	216
			HY-4P2	216	HY-4P2	216
			HY-4P3	216	HY-4P3	216
	ELANTRA		KRCHY-4	362	KRCHY-4	362
	MATRIX					
	SANTA FE					
	TERRACAN					
	EXCEL		HY-3D	215	HY-3D	215
			HY-3DP	215	HY-3DP	215
	EXCEL		HY-3D	215	HY-3D	215
			HY-3DP1	216	HY-3DP1	216
			KAW-4	217	KAW-4	217
	GRAND STAREX		KRCHY-11	362	KRCHY-11	362
	H1					
	H1-BUS					
	I10 EUROPE					
	HB20 (BRAZIL)		HY-11DP1	217	HY-11DP1	217
	I10 EUROPE		KRCKI-7	362	KRCKI-7	362
	I30					
	I30					
	IX35					
	I20		KRCTOYO-18	363	KRCTOYO-18	363
	PONY		HY-1	215	HY-1	215
	PONY		TOYO-14	217	TOYO-14	217

FOR: PARA:	MODEL MODELO			PAG.		PAG.
HYUNDAI®			TOYO-14P	217	TOYO-14P	217
			KAW-4	217	KAW-4	217
	PONY		HY-3D	215	HY-3D	215
	S COUPE		HY-3DP1	216	HY-3DP1	216
	SONATA					
	PONY (CAN)		MIT-2I	217	MIT-2I	217
			MIT-2IP	217	MIT-2IP	217
	PONY (EU)		HY-2	215	HY-2	215
	STELLAR		HY-2P	215	HY-2P	215
			HY-7P	216	HY-7P	216
	SONATA		HY-3	215	HY-3	215
			HY-3P2	216	HY-3P2	216
	SONATA (USA)		HY-6D	216	HY-6D	216
	SONICA		HY-6DP	216	HY-6DP	216
	STAREX		HY-9P2	216	HY-9P2	216
	TIBURON		HY-4	216	HY-4	216
			HY-4P	216	HY-4P	216
			HY-4P2	216	HY-4P2	216
			HY-4P3	216	HY-4P3	216
	TRAJET		KRCHY-6D	362	KRCHY-6D	362
	VAN TRANSP.		HY-8	216	HY-8	216
			HY-8P	216	HY-8P	216
	VARIOUS MODELS		HY-10	216	HY-10	216
			HY-19DP5	217	HY-19DP5	217
			HY-19P5	217	HY-19P5	217
	VARIOUS MODELS		HY-3DP2	216	HY-3DP2	216
	VARIOUS MODELS		HY-11P3	217	HY-11P3	217
	VARIOUS MODELS		HY-11DP3	217	HY-11DP3	217
	VARIOUS MODELS		HY-11P4C1	217	HY-11P4C1	217
HYUNDAI (AUS)®	ILOAD		KRCHY-11	363	KRCHY-11	363
	IMAX					
	LANTRA		KRCHY-4	363	KRCHY-4	363
	LAVITA					
HYUNDAI (CANADA)®	SANTAFE		HY-11DP1	217	HY-11DP1	217
HYUNDAI (USA)®	ELANTRA		KRCHY-11	363	KRCHY-11	363
	SONATA					
	SONATA		HY-18P3		HY-18P3	
	TUCSON					
	VARIOUS MODELS		HY-11P3	218	HY-11P3	218
INFINITI (NISSAN)®	G 20		DAT-10	218	DAT-10	218
	M 30		DAT-10P	218	DAT-10P	218
			DAT-7	218	DAT-7	218
			DAT-7P	218	DAT-7P	218
			DAT-7P1	218	DAT-7P1	218
	M 30		DAT-13	218	DAT-13	218
			DAT-13P	218	DAT-13P	218
			DAT-14	218	DAT-14	218
			DAT-14P	218	DAT-14P	218

FOR: PARA:	MODEL MODELO			PAG.		PAG.
INFINITI (NISSAN)®	VARIOUS MODELS		DAT-16	218	DAT-16	218
INFINITI (USA)®	FX35		KRCDAT-15	363	KRCDAT-15	363
	FX45					
	G20					
	I30					
	I35					
	QX4					
	QX56					
INNOCENTI®	3 CILINDROS				AF-10	219
					FAR-1D	219
	MINI 650				AF-11	219
					FAR-1I	219
	MINI DIESEL				AF-12	219
	MINI MILLE					
	MINI TRE					
	MINI TURBO					
	500		FI-6I	219	FI-6I	219
			FAR-1D	219	FAR-1D	219
	650		FI-6IP	219	FI-6IP	219
			FAR-1I	219	FAR-1I	219
	990		FI-6IP	219	FI-6IP	219
	SMALL 500					
	SMALL 990					
	A40		UN-FP	220	UN-FP	220
	ELBA		FI-1I	219	FI-1I	219
			FI-11P	219	FI-11P	219
	J 4		LF-BL	220	UN-FS	220
	J 5		UN-FS	220		
	JM 3					
	MINI 850					
	MINI 1000					
	MINI 1001					
	MINI COOPER					
	KORAL 45		FI-6I	219	FI-3D	219
	KORAL 55		FI-6IP	219	FI-3DP	219
					FI-3DP5	219
	M.COOPER OR.		STR-2		STR-2	
	M.MK II 850		UN-FS	220	UN-FS	220
	M.DE TOMASO		AF-7I	219	AF-10	219
	MINI 90		AF-7IP	219	AF-11	219
			FAR-1D	219	FAR-1D	219
	MINI 120				AF-12	219
			FAR-1I	219	FAR-1I	219
	M.METALLICA		LF-RO	220	UN-FS	220
			PJ-K	220	PJ-K	220
	M.T.CLUBMAN		LF-ROP	220		
			PJ-KP	220	PJ-KP	220
	MINI MATIC		LF-BL	220	AF-10	219
			FAR-1D	219	FAR-1D	219
			UN-FS	220	AF-11	219
			FAR-1I	219	AF-12	219
					UN-FS	220
	REGENT		LF-BL	220	UN-FT	220

Automóvil. Camioneta  
Automobila. Kamioneta  
Voiture. Camionnette

Auto. Kleintransporter  
Automóvil. Camioneta  
Automóvil. Camioneta

FOR: PARA:	MODEL MODELO			PAG.		PAG.	
INNOCENTI ®	VARIOUS MODELS	-19-	FI-6IP3	219	FI-6IP3	219	
			FI-6IP4	219	FI-6IP4	219	
INTER. HARVESTER ®	T.TERRENO	-19-	GM-6	220	GM-10	220	
			GM-6P	220	GM-10P	220	
			GM-A	220	GM-B	221	
			GM-AP	220	GM-BP	221	
			VARIOUS MODELS	1940-1975	KEN-1	221	KEN-1
			HUD-1	221	HUD-1	221	
IRMSCHER ®	4.0 I	-1981	GM-9	221	OP-R	221	
			GM-9P	221	OP-RP	221	
			GM-J	221	OP-T	221	
			GM-JP	221	OP-TP	221	
			OP-R	221	OP-R	221	
	4.0 I	1981-1986	OP-RP	221	OP-RP	221	
			OP-T	221	OP-T	221	
			OP-TP	221	OP-TP	221	
			OP-R	221	OP-R	221	
			OP-RP	221	OP-RP	221	
	4.0 I	1986-	OP-WHP	221	OP-WHP	221	
			OP-WYP	221	OP-WYP	221	
	C.40 E	-19-	OP-WYP	221	OP-WYP	221	
	ISUZU ®	AMIGO	1988-1991	GM-4	222	GM-4	222
		TF	1988-1991	GM-4P	222	GM-4P	222
			GM-4P1	222	GM-4P1	222	
AMIGO		1991-1994	GM-15D	222	GM-15D	222	
RODEO		1991-1994	GM-15DP	222	GM-15DP	222	
AMIGO		1998-2000	GM-5	222	GM-5	222	
RODEO		1995-1997	GM-5P	222	GM-5P	222	
D-MAX		2002-2006	ISU-3D	222	ISU-3D	222	
			ISU-3DP	222	ISU-3DP	222	
I MARK		1985-1991	GM-2	221	GM-2	221	
			GM-2P	222	GM-2P	222	
I-290		2007-	ISU-3D	222	ISU-3D	222	
I-370		2007-	ISU-3DP	222	ISU-3DP	222	
IMPULSE		1985-1991	MIT-2I	222	MIT-2I	222	
PIAZZA		1985-1991	MIT-2IP	222	MIT-2IP	222	
TROOPER		1985-1991					
IMPULSE		1992-	GM-5	222	GM-5	222	
STYLUS		1992-	GM-5P	222	GM-5P	222	
MODELLOS		1981-1984	MIT-II	222	MIT-II	222	
			MIT-IIP	222	MIT-IIP	222	
NPR		2005-2008	ISU-5		ISU-5		
TROOPER		-19-	MIT-ID	222	MIT-ID	222	
TROOPER		1982-1984	TOYO-14	223	TOYO-14	223	
			TOYO-14P	223	TOYO-14P	223	
TROOPER		1991-	GM-1P	221	GM-1P	221	
VARIOUS MODELS	-	ISU-3DP1	222	ISU-3DP1	222		
VEHY-CROSS	1998-2002	SUZU-10P	223	SUZU-10P	223		
ISUZU (USA) ®	I-350	2006-2006	KRCISU-3D	363	KRCISU-3D	363	
JAGUAR (USA) ®	S-TYPE	2000-2007	KRCFO-6	363	KRCFO-6	363	
	XJ	2004-2009					
	X-TYPE	2002-2007					

FOR: PARA:	MODEL MODELO			PAG.		PAG.
JAGUAR ®	E	1970-1974	FO-D	223	UN-1FS	224
			FO-FR	223	UN-FS	224
			FO-FRP	223		
			WAS-2P	224		
			JAU-1P	223	JAU-1P	223
	MAJESTIC	1989-1994				
	SOVEREIGN	1989-1994				
	VANDEN PLAS	1989-1994				
	XJ 6	1989-1994				
	S-TYPE	1999-2009	KRCFO-6	363	KRCFO-6	363
	XJ	2002-2009				
	X-TYPE	2001-2009				
	VANDEN PLAS	1988-1989	FO-E-TC	223	FO-E-TC	223
	XJ 6-40	1988-1989	FO-E-TCP	223	FO-E-TCP	223
	XJ 6	1971-1975	FO-D	223	IN-4	223
			FO-FR	223	UN-1FS	224
			FO-FRP	223	UN-FS	224
			WAS-1	224	WAS-1	224
			WAS-2P	224	UN-FT	224
	XJ 6	1976-1978	FO-FR	223	FO-5	223
			WAS-1	224	WAS-1	224
			FO-FRP	223		
			WAS-2P	224		
	XJ 6-12	1979-1987	FO-FR	223	CEM-JC	223
			FO-FRP	223		
		WAS-1	224			
		WAS-2P	224			
XJS	1975-	FO-FR	223	UN-FT	224	
		FO-FRP	223			
		WAS-2P	224			
XJS	1976-	FO-FR	223	LF-WR	223	
		FO-FRP	223			
		FO-TC	223			
		WAS-2P	224			
XJS	1976-1977	LF-WR	223	FO-TC	223	
XJS	1978-1987	FO-FR	223	LF-WR	223	
		FO-FRP	223			
		CEM-JC	223			
		FO-5	223			
		WAS-2P	224			
XJS	1988-	JAU-1P	223	JAU-1P	223	
		FO-E-TC	223			
		FO-E-TCP	223			
JDM ®	ABACA	2005-2012	SIX-3P	224	SIX-3P	224
	ALBIZIA	2003-2012				
	ALOES	2008-2012				
	ROSKY	2012-				
JEEP ®	BRIAR WOOD	1991-1992	CHR-9	224	CHR-9	224
	CHEROKEE	1991-1992	CHR-9P	224	CHR-9P	224
	COMANCHE	1991-1992				
	LAREDO	1991-1992				
	LTD	1991-1992				
	WRANGLER	1991-1992				
	CHEROKEE	1993-1998	CHR-10	224	CHR-10	224
	COMANCHE	1993-	CHR-10P	224	CHR-10P	224
	COUNTRY	1993-				

FOR: PARA:	MODEL MODELO			PAG.		PAG.
JEEP ®	G.CHEROKEE	1993-1998				
	G.WAGONEER	1993-				
	LAREDO	1993-				
	LTD	1993-				
	RENEGADE	1993-				
	SAHARA	1993-				
	SPURR	1993-				
	WAGONEER	1993-				
	WRANGLER	1993-				
	COMANCHE	1985-1990	GM-9	225		
	SCRAMBLER	1985-1990	GM-9P	225		
	WAGONEERS	1985-1990	GM-J	225		
	WRANGLER	1985-1990	GM-JP	225		
	COMMANDO D	-19-	FEM-3I	225	CL-4I	225
	COMPASS	2007-2015	KRCCHR-15	363	KRCCHR-15	363
	LIBERTY	2005-2013				
	PATRIOT	2007-2015				
	WRANGLER	2007-2015				
	PIONNER	-1991	GM-9	225		
			BS-4D	224		
			GM-9P	225		
			YA-8D	225		
			GM-J	225		
			GM-JP	225		
	RENEGADE	1979-1984	GM-9	225	YA-11D	225
		GM-9P	225			
		GM-J	225			
		GM-JP	225			
VARIOUS MODELS	-	AMM-2	224	AMM-2	224	
		AMM-1	224	AMM-1	224	
		CHR-14	224	CHR-14	224	
		CHR-14P	225	CHR-14P	225	
		HUD-1	225	HUD-1	225	
		KEN-1	225	KEN-1	225	
KENWORTH ®	VARIOUS MODELS	-	KEN-1	226	KEN-1	226
			HUD-1	225	HUD-1	225
KIA ®	BONGO 3	2004-2014	KI-6P			
	K SERIES	2004-				
	CARNIVAL	1999-	KI-3DP	226	KI-3DP	226
	CLARENCE	2001-				
	PRIDE	1999-				
	RIO	2001-				
	SHUMA	1998-				
	SHUMA	1998-2000				
	SORENTO	1998-				
	CEED	2006-2012	KRCKI-7	363	KRCKI-7	363
	RIO	2012-2014				
	SPORTAGE	2010-2014				
	SPORTAGE	2014-2016				
	CLARUS	1998-2001	KI-3DP	226	KI-3DP	226
		KI-3P	226	KI-3P	226	
PRIDE 1.1 L	1992-1994	KI-1D	226	KI-1D	226	
PRIDE 1.3 LX	1992-1994	KI-1DP	226	KI-1DP	226	
SEPHIA (USA)	1994-1995					

FOR: PARA:	MODEL MODELO			PAG.		PAG.	
KIA ®	SEPHIA 1.6 I	1993-1994					
	SPORTAGE	1995-1996					
	SEPHIA (USA)	1994-	KI-1DP1	226	KI-1DP1	226	
	SPORTAGE	2001-2004	KI-3P	226	KI-3P	226	
	SPORTAGE USA	1996-	KI-2D	226	KI-2D	226	
	VARIOUS MODELS	-	KI-12P	226	KI-12P	226	
			HY-12P3	226	HY-12P3	226	
			KI-11P	226	KI-11P	226	
			KI-12DP	226	KI-12DP	226	
	VARIOUS MODELS	2006-2018	HY-11DP1	226	HY-11DP1	226	
			HY-11DP3	226	HY-11DP3	226	
	VARIOUS MODELS	2006-2020	HY-11P3	226	HY-11P3	226	
	VARIOUS MODELS	2010-2015	HY-18PIC1	226	HY-18PIC1	226	
	KIA (USA) ®	FORTE	2010-2013	KRCHY-11D	363	KRCHY-11D	363
		SOUL	2010-2011				
	SPORTAGE	2005-2008	KRCHY-4	363	KRCHY-4	363	
LA FORZA ®	FORZA 5.0 V8	1989-			GI0B-3P		
LADA VAZ ®	120	1972-			IMS-5P	226	
	1200	1972-	NE-3		IMS-3	226	
			NE-3P		IMS-3P	226	
			NE-3P1		IMS-5	226	
			NE-3P2				
	1300	1972-	NE-3		IMS-3	226	
	1500	1972-	NE-3P		IMS-3P	226	
	1600	1972-	NE-3P1		IMS-5	226	
	2101	1972-	NE-3P2		IMS-5P	226	
	21011	1972-					
	2102	1972-					
	2103	1972-					
	2104	1972-					
	21043	1972-					
	2105	1972-					
	2106	1972-					
	21061	1972-					
	2107	1972-					
	NIVA	-19-					
	RIVA	-19-					
	3110	-19-	LA-3D		LA-2		
			LA-3DP		LA-2P		
			LA-4D				
			LA-4DP				
	4x4	-19-	LA-1D		LA-1D		
4x4 G.LARGE	-19-	LA-1DP		LA-1DP			
KAMA	1984-	LA-2		LA-2			
SAGONA	-19-	LA-2P		LA			

Automóvil. Camioneta  
Automobila. Kamioneta  
Voiture. Camionnette

Auto. Kleintransporter  
Automóvil. Camioneta  
Automóvil. Camioneta

FOR: PARA:	MODEL MODELO			PAG.		PAG.
<b>LADA VAZ</b> ®						
	SAMARA	1992-	NE-3P2	LA-3D	LA-2	
				LA-3DP	LA-2P	
	VARIOUS MODELS	-	NE-3D	NE-3D		
<b>LAMBORGHINI</b> ®	COUNTACH	-19-	AF-7I	227	IMS-3	228
	JALPA	-19-	AF-7IP	228	IMS-3P	228
	URRACO	-19-	AF-7IP1	228	IMS-5	228
					IMS-5P	228
	DIABLO COU.	-19-	AF-7I	227	IMS-3	228
				AF-5D	AF-5D	227
	DIABLO ROA.	-19-	AF-7IP	228	IMS-3P	228
				AF-7IP1	IMS-5	228
					IMS-5P	228
				AF-5I	AF-5I	227
				AF-6D	AF-6D	227
				AF-6I	AF-6I	227
	ESPADA	-19-	AF-7I	227	AF-5I	227
				AF-6D	AF-6D	227
				AF-7IP	AF-6I	227
				AF-7IP1		228
	MIURA	-19-	BH-1	228	AF-4D	227
				BH-1P	AF-4I	227
					AF-5D	227
					AF-5I	227
					AF-6D	227
					AF-6I	227
<b>LANCIA</b> ®	2000	-1972	GIOB-1D	229	GIOB-2I	229
	APPIA	-1972	GIOB-1DP	229	GIOB-2IP	229
	FLAVIA	-1972				
	FULVIA	-1972				
	2000	1972-	GIOB-1D	229	GIOB-2I	229
	FULVIA	1972-	GIOB-1DP	229	GIOB-2IP	229
			SIP-3	230		
	BETA	1972-1982	AF-7I	228	GIOB-3P	
	DELTA	1979-1982	AF-7IP	228		
	GAMMA	1972-1982	FI-9I	229		
			FI-9IP	229		
	BETA	1975-1980	AF-7I	228	AF-10	228
	MONTECARLO	1975-1980	AF-7IP	228	AF-11	228
					AF-12	228
	DEDRA	1989-1995	FI-13	229	FI-13	229
	DEDRA S.W.	1994-	FI-13P	229	FI-13P	229
	DELTA	1993-1995	FI-14P	229	FI-14P	229
	DELTA	1983-	FI-3D	228	FI-6IP1	229
			FI-3DP	228	FI-6IP2	229
			FI-3DP3	228	FI-6IP4	228
			FI-6I	229	GIOB-3P	
			FI-6IP	229		
			FI-6IP1	229		
			FI-6IP2	229		
			FI-6IP3	229		
			FI-6IP4	228		
	DELTA	1984-1992	FI-11	229	GIOB-3P	
	PRISMA	1984-1989	FI-11P	229		
	LANCIA Z	1994-	SIX-3P1	230	SIX-3P1	230

FOR: PARA:	MODEL MODELO			PAG.		PAG.
<b>LANCIA</b> ®	Z 2000	1994-				
	PHEDRA	2006-2010	KRCHU-HCA	363	KRCHU-HCA	363
	THEMA	1984-	FI-10	228	FI-10	228
			FI-10P	228	FI-10P	228
			FI-11	229	FI-11	229
			FI-11P	229	FI-11P	229
	TREVI	1980-	FI-9I	229	GIOB-3P	
			FI-9IP	229		
	VARIOUS MODELS	-	FI-16C1	356	FI-16C1	356
			FI-16C3	356	FI-16C3	356
	VARIOUS MODELS	2000-			FI-16P1	229
<b>LAND-RANGE ROVER</b> ®	90 2500	1988-1991	IMS-7	230	AB-6I	230
	90 3500	1988-1991	IMS-7P	230		
	110 2500	1985-1987				
	SANTANA	1987-1991				
	109	1982-1983	LF-RO	230	UN-FS	231
	88	1982-1983	LF-ROP	230		
	109	1984-	LF-RO	230	UN-FS	231
			UN-FT	231	UN-FT	231
	110	1984-1985	LF-ROP	230		
	88	1984-				
	109	1985-1987	LF-RO	230	AB-6I	230
			UN-FT	231	UN-FT	231
	110	1986-1987	LF-ROP	230		
	88	1985-1987				
	SANTANA	1985-1987				
	110	1985-1986	LF-RO	230	LF-RO	230
	90	1985-1986	LF-ROP	230	LF-ROP	230
	110	1987-1991	LF-RO	230	UN-FT	231
	90	1987-1991	LF-ROP	230		
	DEFENDER	1990-				
	110 3500	1985-1987	IMS-7	230		
			IMS-7P	230		
			AB-6I	230		
	DISCOVERY	1989-1993	NE-11	230	NE-11	230
			NE-11P1	230	NE-11P1	230
			NE-11P2	230	NE-11P2	230
	DISCOVERY	1994-1997	NE-52P	231	NE-52P	231
	MODELOS	1970-1972	UN-FS	231	UN-FP	231
	MODELOS	1973-1981	UN-FS	231	UN-FS	231
	R.ROVER	-1983	UN-NH	231	UN-NH	231
			UN-NHP		UN-NHP	
			UN-FS	231	UN-FS	231
	R.ROVER	1984-1988	NE-11	230	NE-11	230
			NE-11P	230	NE-11P	230
			NE-11P1	230	NE-11P1	230
			NE-11P2	230	NE-11P2	230
			NE-24	230	NE-24	230
			NE-24P	230	NE-24P	230
			NE-24P1	230	NE-24P1	230
			UN-FS	231	UN-FS	231
			UN-FT	231	UN-FT	231
	R.ROVER	1989-1997	NE-11	230	NE-11	230
			NE-11P	230	NE-11P	230
<b>LAND-RANGE ROVER</b> ®						

FOR: PARA:	MODEL MODELO			PAG.		PAG.
<b>LEXUS (TOYOTA) (USA)</b> ®	ES330	2004-2006	KRCTOYO-30	363	KRCTOYO-30	363
	RX330	2003-2008				
	RX350	2003-2008				
	RX400H	2005-2008				
<b>LEXUS (TOYOTA)</b> ®	250 ES	1989-	TOYO-18P	231	TOYO-18P	231
	300 ES	1989-				
	400 LS	1989-				
	COUPE 300 SC	1991-				
	COUPE 400 SC	1991-				
	GS300	2000-2004	KRCTOYO-30	363	KRCTOYO-30	363
	GS430	2001-2005				
	IS200	1999-2005				
	IS300	2001-2005				
	RX300	1999-2003				
	VARIOUS MODELS	-	TOYO-30P1	231	TOYO-30P1	231
<b>LIGIER</b> ®	IXO	2010-	SIX-3P	231	SIX-3P	231
	JS	-19-				
	NOVA	1999-2004				
	OPTIMAX	2010-				
	X-T00	2006-2012				
<b>LINCOLN</b> ®	AVIATOR	2003-2005	KRCFO-30D	364	KRCFO-30D	364
	LS	2003-2006				
	MARK LT	2006-2008				
	MKS	2009-2009				
	MKX	2007-2010				
	MKZ	2007-2010				
	NAVIGATOR	2002-2010				
	NAVIGATOR	2011-2012				
	TOWN CAR	2003-2011				
	ZEPHYR	2006-2006				
	CONTINENTAL	1967-1984	FO-2	231	FO-1	231
	CONTINENTAL	1985-1991	FO-20D	231	FO-20D	231
			FO-1	231	FO-1	231
	CONTINENTAL	1991-1998	FO-11D	231	FO-11D	231
			FO-1	231	FO-1	231
	LS	2000-2002	KRCFO-15D	364	KRCFO-15D	364
	NAVIGATOR	1998-2002				
	TOWN CAR	1998-2002				
	MARK SERIES	1985-1991	FO-11D	231	FO-11D	231
			FO-1	231	FO-1	231
			FO-20D	231	FO-20D	231
<b>LOTUS</b> ®	ECLAT	-19-	TOYO-K1	232	TOYO-K1	232
	EXCEL SE	-19-	TOYO-K1P	232	TOYO-K1P	232
	ELAN SE	1991-	OP-D	232	OP-D	232
			GM-12	232	GM-12	232
			GM-12P	232	GM-12P	232
			OP-DP	232	OP-DP	232
			GM-H	232	GM-H	232
			GM-HP	232	GM-HP	232
	ESPRIT 2.2	-19-	LF-RO	232	UN-FT	233
			WAS-6	233	WAS-6	233

FOR: PARA:	MODEL MODELO			PAG.		PAG.
<b>LOTUS</b> ®	ESPRIT TURBO	-19-	LF-ROP	232		
			WAS-6P		WAS-6P	
	ESPRIT COUPE	1991-	LF-RO	232	UN-FT	233
			LF-ROP	232		
	VARIOUS MODELS	-	FO-FR	231	UN-FS	232
			FO-FRP	232	UN-FT	233
			LF-RO	232		
			LF-ROP	232		
<b>MACK</b> ®	VARIOUS MODELS	-	KEN-1	233	KEN-1	233
			HUD-1	233	HUD-1	233
<b>MAHINDRA</b> ®	VARIOUS MODELS	-	TAT-2DP	233	TAT-2DP	233
<b>MARUTI</b> ®	800	1991-1992	SUZU-7	233	SUZU-7	233
	800 LUXE	1991-1992	SUZU-7P	233	SUZU-7P	233
	800 S.LUXE	1991-1992				
	VARIOUS MODELS	-	MAR-1P	233	MAR-1P	233
<b>MASERATI</b> ®	BITURBO	1981-	LF-RO	234	AF-10	233
			AF-5D	233	AF-5D	233
	GHIBLI	1986-	LF-ROP	234	AF-11	233
			AF-6D	233	AF-6D	233
	KARIF	1986-			AF-12	233
	SHAMAL	1986-				
	SPYDER	1986-				
	BORA	1971-1976	AF-7I	233	RO-5D	234
			GIOB-2I	234	GIOB-2I	234
			AF-7IP	233		
			AF-7IP1	233		



Automóvil. Camioneta  
Automobila. Kamioneta  
Voiture. Camionnette

Auto. Kleintransporter  
Automóvil. Camioneta  
Automóvil. Camioneta

FOR: PARA:	MODEL MODELO			PAG.		PAG.
MAZDA®	MX6			1990-1992		
	323 S.W.			1977-1986	MAZ-2D	234
	929 S.W.			1980-1982	MAZ-2DP	235
	323			1977-1982		
	626			1978-1982		
	929			1980-1982		
	323 S.W.			1986-1996	MAZ-3D	235
	626 S.W.			1986-1992	MAZ-6DP	235
	929 S.W.			1982-		
	121			1988-1990		
	323			1983-1989		
	626			1987-1991		
	727			1987-1991		
	COSMO			1984-1986		
	MX6			1986-1989		
	RX7			1987-1991		
	616 CAP.			-1970	DAT-3I	234
	616 SNA			-1970		MAZ-2DP
	RX2 CAPPE.			1970-1971		
	616 CAPE.			1971-1973	DAT-11D	234
	618			1971-1973	DAT-11DP	235
	RX2 CAPPE.			1974-1977	WAS-2P	236
	RX3			1974-1977		
	626 GL			1981-	CHR-3	234
					NE-22P2	236
	626 S.W.			1993-1996	MAZ-5D	235
	RX7			1991-	MAZ-5DP	235
	818 1.3			-1971	DAT-3I	234
	818 1.5			-1971		
	1800			1971-1972		
	929 GLX			1987-	MAZ-3D	235
					MAZ-3DP	235
					MAZ-6DP	235
	1200			1970-1972	DAT-11D	234
	1800			1970-1971	DAT-11DP	
					WAS-2P	236
	121			1991-1992	MAZ-5D	235
					MAZ-5DP	235
					MAZ-7D	235
					MAZ-7DP	235
	121			1993-1994	MAZ-13D	236
	323			1992-1994	MAZ-13DP	236
	MX3			1992-1995	MAZ-13DP1	236
	MX5			1992-1995	MAZ-7D	235
	RX7			1992-	MAZ-7DP	235
	XEDOS			1992-1996		
	121			1995-	FO-6P	234
	1600			1972-	DAT-3I	234
	R 100			1970-1971		
	2			2002-2006	KRCMAZ-11D	364
	2			2007-2010		
	2			2007-2014		
	3			2004-2008		
	3			2008-2011		
	3			2012-2013		
	6			2002-2004		
	6			2004-2008		

FOR: PARA:	MODEL MODELO			PAG.		PAG.
MAZDA®	6			2008-2012		
	CX7			2006-2012		
	CX9			2007-2009		
	M5			2005-2010		
	M5			2010-2015		
	MX-5			2005-2012		
	323			-19-	MAZ-4P	235
	323			1982-1983	MAZ-3D	235
					MAZ-3DP	235
					MAZ-3I	235
					MAZ-3IP	235
	323			1989-1992	MAZ-3D	235
					MAZ-7D	235
					MAZ-7DP	235
	323			1995-		MAZ-7DP1
	MX3			1995-		
	MX5			1995-		
	626			1982-1987	MAZ-3D	235
	929			1982-1986	MAZ-3DP	235
					MAZ-3I	235
					MAZ-6DP	235
					MAZ-6P	235
	626			1991-	MAZ-7D	235
					MAZ-7DP	235
					MAZ-7DP1	235
	626			1991-1995	MAZ-13D	236
	MX6			1992-1995	MAZ-13DP	236
					MAZ-13DP1	236
	626			1995-1997		MAZ-13D
	MX6			1995-1997		MAZ-13DP
	XEDOS 6			1995-1997		MAZ-13DP1
	808			1971-1977	DAT-11D	234
	818			1971-1977	DAT-11DP	235
					WAS-2P	236
						MAZ-2I
						MAZ-2IP
	929			1973-1980	DAT-11D	234
					DAT-11DP	235
					WAS-2P	236
						MAZ-2I
						MAZ-2IP
	ARTIS			-19-	MAZ-21DP1	236
	B 1800			1970-1971	MAZ-1I	234
	BT50			2011-2015	KRCFO-24	364
	COSMO			1975-1979	MAZ-16	236
	COSMO			1980-	MAZ-3D	235
					MAZ-3DP	235
	COSMO			1982-1983	MAZ-3D	235
					MAZ-3DP	235
					MAZ-3I	235
					MAZ-6P	235
	E 1600			1986-	MAZ-2D	234
					MAZ-2DP	235
					MAZ-2I	234
					MAZ-2IP	235
					MAZ-3D	235
					MAZ-3DP	235
					MAZ-3I	235
					MAZ-3IP	235

FOR: PARA:	MODEL MODELO			PAG.		PAG.
MAZDA®	EUNOS 800			1993-	TOYO-18P	236
	XEDOS 9			1993-1996		
	GLC 323			1983-1989	MAZ-3D	235
					MAZ-3DP	235
	MIATA			1989-1992	MAZ-3D	235
					MAZ-7D	235
	MX5			1989-1992	MAZ-7D	235
					MAZ-7DP	235
					MAZ-7DP1	235
	MPV			1989-	MAZ-7D	235
					MAZ-7DP	235
	MX3			1991-1992	MAZ-7D	235
					MAZ-7DP	235
					MAZ-7DP1	235
	NAVAJO			1991-	MAZ-8D	235
					MAZ-8DP	235
	R 100			1972-	DAT-11D	234
	R 1200			1972-	DAT-11DP	
					WAS-2P	236
	RX2			1972-1973	DAT-11D	234
					DAT-11DP	235
					WAS-2P	236
	RX4 LUCE			1972-1978	MAZ-2D	234
	RX5 COSMO			1972-1978	MAZ-2DP	235
	RX7 COUPE			1972-1978	MAZ-2I	234
					MAZ-2IP	235
	RX7			1983-1986	MAZ-3D	235
					MAZ-3DP	235
					MAZ-6DP	235
					MAZ-6DP	235
	VARIOUS MODELS			-	MAZ-1D	234
					MAZ-1I	234
					MAZ-2D	234
					MAZ-2I	234
					MAZ-2IP	235
					MAZ-2IP	235
					DAT-1I	234
					DAT-1IP	234
					MAZ-15D	236
					MAZ-6	235
					MAZ-11D	235
					MAZ-11DP1	236
					MAZ-4	235
					MAZ-14D	236
MAZDA (USA)®	2			2011-2013	KRCMAZ-11D	364
	3			2003-2005		
	3			2007-2008		
	3			2010-2013		
	6			2003-2005		
	6			2010-2012		
	CX7			2006-2008		
	CX7			2009-2012		
	CX9			2009-2013		
	M5			2005-2010		

FOR: PARA:	MODEL MODELO			PAG.		PAG.
MAZDA (USA)®	M5			2010-2015		
	MX-5			2005-2012		
	MX-5			2009-2015		
	RX8			2004-2008		
	B-SERIES			1999-2000	KRCFO-15D	364
	B-SERIES			2001-2009		
	TRIBUTE			2001-2004		
	TRIBUTE			2005-2007		
	TRIBUTE			2008-2011		
MERCEDES®	180C			1993-	ME-7P	237
	200C			1993-	ME-8P	237
	220C			1993-		
	280C			1993-		
	300C			1993-		
	190 ALARM			1986-1992	ME-10P	237
					ME-11P	237
					ME-12P	237
	206D			-19-	ME-VA	238
	306D			-19-		
	207D			-1992	ME-HM	237
	207F			-1992	ME-HMP	237
	207K			-1992		
	208D			-1992		
	209D			-1992		
	240D			1973-1976	ME-HD	237
	200			1973-1974	ME-HDP	237
	220			1973-1974	ME-HF	237
	230			1973-1974	ME-HFP	237
	250			1973-1977	ME-HM	237
	280			1973-1974	ME-HMP	237
	350			1973-	ME-HZ	237
	380			1973-1977	ME-HZP	237
	450			1973-1979		
	240D			1976-	ME-HU	238
	300D			1976-	ME-HUP	238
	200			1976-1977	ME-NU	238
					ME-NUP	238
	307D			-1992	ME-HM	237
	308D			1992-	ME-HMP	237
	L 508			-1991		
	L 608			-1991		
	LN 914			-1991		
	MB 308DT			-1991		
	MB 408DT			-1991		
	U 900			-1991		
	U 1700			-1991		
	1000			1984-	ME-10P	237
	190			1984-1986	ME-2P	237
	200			1984-	ME-3P	237
	230			1984-	ME-4P	237
	250			1984-	ME-5P	237
	260			1984-	ME-6P	237
	280			1979-		
	300			1980-		
	360			1984-		
	380			1979-		

Automóvil. Camioneta  
Automobila. Kamioneta  
Voiture. Camionnette

Auto. Kleintransporter  
Automóvil. Camioneta  
Automóvil. Camioneta

FOR: PARA:	MODEL MODELO			PAG.		PAG.
MERCEDES ®	420			1984-		
	450			1979-		
	500			1979-		
	560			1984-		
	1117		ME-HMP	1996-	237	ME-HMP 237
	1300			1996-		
	1500			1996-		
	711			1996-		
	814			1996-		
	817			1996-		
	917			1996-		
	SPRINTER			1996-		
	VARIO			1996-		
	190		ME-4P	1986-	237	ME-4P 237
			ME-5P		237	ME-5P 237
	200		ME-HD	1974-1975	237	ME-HD 237
	220		ME-HDP	1974-	237	ME-HDP 237
	230		ME-HZ	1974-1977	237	ME-HZ 237
	240		ME-HZP	1974-1977	237	ME-HZP 237
	280			1974-1979		
	200		ME-HF	1975-1976	237	ME-HF 237
			ME-HFP		237	ME-HFP 237
			ME-HM		237	ME-HM 237
			ME-HMP		237	ME-HMP 237
	200		ME-HU	1977-1984	238	ME-HU 238
	230		ME-HUP	1977-1984	238	ME-HUP 238
	240		ME-HY	1977-	238	ME-HY 238
	250		ME-HYP	1977-1984	238	ME-HYP 238
	300		ME-NU	1977-1980	238	ME-NU 238
	380		ME-NUP	1977-1979	238	ME-NUP 238
			ME-NY		238	ME-NY 238
			ME-NYP		238	ME-NYP 238
	220		ME-HF	-1972	237	ME-HF 237
	230		ME-HFP	-1972	237	ME-HFP 237
	250		ME-HZ	-1972	237	ME-HZ 237
	280		ME-HZP	-1972	237	ME-HZP 237
	300			-1972		
	350			-1972		
	7200			-1972		
	230		ME-HF	-19-	237	ME-HF 237
	240		ME-HFP	-19-	237	ME-HFP 237
	280		ME-HM	-19-	237	ME-HM 237
	300		ME-HMP	-19-	237	ME-HMP 237
	TODOT. 4WD		ME-HZ	-19-	237	ME-HZ 237
			ME-HZP		237	ME-HZP 237
	400		ME-2P	-1994	237	ME-2P 237
	600		ME-3P	-1994	237	ME-3P 237
	MB 100D		ME-1	-1994	236	ME-1 236
			ME-1P		237	ME-1P 237
	VARIOUS MODELS		NE-61D	-	238	
			NE-62		238	
			ME-L		238	BOM-2 236
						BOM-2D 236
			ME-L		238	
	VITO		ME-HMP	1996-	237	ME-HMP 237
			ME-HZ		237	ME-HZ 237
			ME-HZP		237	ME-HZP 237

FOR: PARA:	MODEL MODELO			PAG.		PAG.
MERCEDES ®	VITO			1997-	ME-HMLP 237	ME-HMLP 237
MERCURY ®	CAPRI			1970-1971	FO-D 239	FO-XL 239
	CAPRI			1978-1983		
	CAPRI			1972-1978	FO-E-TC 239	FO-E-TC 239
					FO-E-TCP 239	FO-E-TCP 239
					FO-TC 239	FO-TC 239
	CAPRI			1983-1991	FO-2 238	FO-2 238
					FO-1 238	FO-1 238
	CAPRI			1991-	FO-14DP 239	FO-14DP 239
					FO-7P 238	FO-7P 238
	COUGAR			1967-1984	FO-2 238	FO-1 238
	MARQUIS			1967-1989		
	COUGAR			1990-	FO-11D 238	FO-11D 238
	MARQUIS			1991-	FO-20D 239	FO-20D 239
	TOPAZ			1990-		
	COUGAR			1999-2001	KRCFO-16 364	KRCFO-16 364
	MYSTIQUE			1995-2000		
	G.MARQUIS			1993-1998	FO-8D 238	FO-8D 238
	MERCURY			1993-1996	FO-8DPI 238	FO-8DPI 238
	SABLE			1993-1996		
	GRAND MARQUIS			2007-2011	KRCFO-30D 364	KRCFO-30D 364
	MARAUDER			2003-2005		
	MARINER			2005-2006		
	MARINER			2007-2010		
	MARINER			2011-2011		
	MILAN			2006-2006		
	MILAN			2007-2011		
	MONTEGO			2005-2007		
	MONTEREY			2004-2007		
	MOUNTAINEER			2002-2010		
	SABLE LS, LE, SHO			2000-2006		
	SABLE LS, LE, SHO			2008-2009		
	MERCURY			-1993	FO-2 238	FO-2 238
	MOUNTAINEER			1998-2001	KRCFO-15D 364	KRCFO-15D 364
	SABLE			1993-1997		
	SABLE LS, LE, SHO			1998-1999		
	MYSTIQUE			1995-1997	FO-8D 238	FO-8D 238
	SABLE GS/LS			1996-1997	FO-15D 239	FO-15D 239
					FO-15DP 239	FO-15DP 239
	TOPAZ			1983-1985	FO-2 238	FO-1 238
	TRACER			1987-1990	FO-14DP 239	FO-14DP 239
					FO-7P 238	FO-7P 238
	TRACER			1990-	FO-8D 238	FO-8D 238
					FO-8DP 238	FO-8DP 238
					FO-8DPI 238	FO-8DPI 238
MG ®	MG			1970-1974	UN-NH 240	UN-FS 240
					IN-4 239	IN-4 239
	MGB			1970-1974	UN-NHP	UN-FS 240
	MG			1975-1977	NE-1 239	UN-FS 240
					NE-1P 239	
	MG			1978-	NE-10 239	UN-FS 240
					NE-10P 239	UN-FT 240
	MGB			1975-1978	NE-1 239	UN-FS 240

FOR: PARA:	MODEL MODELO			PAG.		PAG.
MG ®				NE-1P	239	
	MGB GT			1970-1975	UN-NH 240	UN-FS 240
					UN-NHP	
	MGF			1997-	NE-10P 239	NE-10P 239
	VARIOUS MODELS			-	UN-FP 240	UN-FP 240
					UN-FS 240	UN-FS 240
MICROCAR ®	FAMILY			2007-2009	SIX-3P 240	SIX-3P 240
	M.GO			2009-		
	NEWSTREET			2008-		
	PRATIC			2008-		
	VIRGO			2008-		
MITSUBISHI ®	3000 GT/R/SL			-19-	MIT-12 241	MIT-12 241
	BRAVO			-19-	MIT-7 241	MIT-7 241
	CHARIOT			1987-	MIT-7P 241	MIT-7P 241
	COLT			1987-1993		
	DIAMANTE			1992-		
	ECLIPSE			1987-		
	ETERNA			1989-		
	EXPO			-19-		
	GALANT			1987-1996		
	L 200			1987-		
	L 300			1987-		
	LANCER			1987-1996		
	MINICAB			1987-		
	MIRAGE			1987-1993		
	MONTERO			1992-1996		
	MX SUPER A.R			-19-		
	NIMBUS			1987-		
	PAJERO			1992-1996		
	S.RUNNER			1992-1998		
	SHOGUN			-19-		
	SPACE WAGON			1985-		
	CANTER			1997-	MIT-15P 241	MIT-15P 241
	CELESTE			1972-1980	MIT-II 240	MIT-II 240
	COLT			1972-1980	MIT-IIP 240	MIT-IIP 240
	GALANT			1972-1980		
	LAMBDA			1972-1980		
	LANCER			1972-1980		
	MINICA			1972-1980		
	STARION			1972-1980		
	COLT			1981-1984	MIT-2I 240	MIT-2I 240
	CORDIA			1981-1984	MIT-2IP 240	MIT-2IP 240
	DEBONAIR			1981-1984		
	ETERNA			1981-1983		
	GALANT			1981-1983		
	L 300			-1983		
	L 300 VAN			1981-1984		
	LANCER			1981-1983		
	MINICA			1981-1983		
	MONTERO			1981-1992		
	PAJERO			1981-1992		
	SAPPORO			1981-1984		
	SHOGUN			1981-1984		
	SIGMA			1981-1984		
	SPACE WAGON			1981-1983		

FOR: PARA:	MODEL MODELO			PAG.		PAG.
MITSUBISHI ®	STARION			1981-1983		
	VISTA			-1993		
	COLT			1984-1987	MIT-3 240	MIT-3 240
	DEBONAIR			1983-1985	MIT-3P 240	MIT-3P 240
	ETERNA			1983-1989	MIT-4 241	MIT-4 241
	GALANT			1983-1987	MIT-4P 241	MIT-4P 241
	L 300			1983-1987		
	LANCER			1983-1987		
	MINICA			1983-1987		
	ORCHID			1983-1985		
	SPACE WAGON			1983-1985		
	STARION			1983-1985		
	TREDIA			1983-1985		
	COLT			1993-1996	MIT-13D 241	MIT-13D 241
	MIRAGE			1993-	MIT-14D 241	MIT-14D 241
					MIT-8D 241	MIT-8D 241
					MIT-8DP 241	MIT-8DP 241
	COLT			2005-2010	KRCMIT-8D 364	KRCMIT-8D 364
	GRANDIS			2003-2011		
	LANCER			2006-2010		
	GALANT			1991-	MIT-1D 240	MIT-1D 240
	LANCER			-19-		
	MONTERO			-19-		
	INTERCOOLER			1992-	CHR-17 240	CHR-17 240
					MIT-12 241	MIT-12 241
					MIT-7 241	MIT-7 241
					MIT-7P 241	MIT-7P 241
	L 400			1997-	MIT-7P 241	MIT-7P 241
	L200			2006-2011	KRCMIT-12 364	KRCMIT-12 364
	MONTERO			2006-2014		
	MONTERO SPORT			2008-2014		
	PAJERO			2006-2011		
	PAJERO			2006-2014		
	PAJERO			2008-2014		
	PICK UP			-19-	MIT-1D 240	MIT-1D 240
	PRECIS			1986-	HY-3D 240	HY-3D 240
					HY-3DPI 240	HY-3DPI 240
	SPACE GEAR			1995-	MIT-12 241	MIT-12 241
					MIT-7 241	MIT-7 241
					MIT-7P 241	MIT-7P 241
	SUMMIT			1993-	MIT-8D 241	MIT-8D 241
	VISTA			1993-	MIT-8DP 241	MIT-8DP 241
	VARIOUS MODELS			-	MIT-1DP 240	MIT-1DP 240
					MIT-2D 240	MIT-2D 240
					MIT-2DP 240	MIT-2DP 240
					MIT-8DP2 241	MIT-8DP2 241
					MIT-5 241	MIT-5 241
					MIT-5P 241	MIT-5P 241
					MIT-6 241	MIT-6 241
					MIT-6P 241	MIT-6P 241
MITSUBISHI (AUSTRALIA) ®	MIRAGE			2012-	KRCMIT-12 364	KRCMIT-12 364
	TRITON			2006-2015		
MITSUBISHI (USA) ®	DIAMANTE			2000-2003	KRCMIT-12 364	KRCMIT-12 364

Automóvil. Camioneta  
Automobila. Kamioneta  
Voiture. Camionnette

Auto. Kleintransporter  
Automóvil. Camioneta  
Automóvil. Camioneta

FOR: PARA:	MODEL MODELO			PAG.		PAG.
MITSUBISHI (USA) ®	DIAMANTE	2004-2004				
	MONTERO	2001-2006				
	MONTERO SPORT	2000-2000				
	MONTERO SPORT	2001-2004				
	ECLIPSEEXPORTACION A CHINA	1999-2000	KRCMIT-18	365	KRCMIT-18	365
	ECLIPSEEXPORTACION A CHINA	2001-2001				
	ECLIPSEEXPORTACION A CHINA	2002-2005				
	ENDEAVOR	2004-2005				
	ENDEAVOR	2006-2006				
	GALANT	2000-2001				
	GALANT	2002-2003				
	GALANT	2004-2005				
LANCER EVO 8 EUROPE	2003-2006	KRCMIT-8D	365	KRCMIT-8D	365	
OUTLANDER	2003-2006					

FOR: PARA:	MODEL MODELO			PAG.		PAG.
MOSKVITCH ®	2135	-19-	NE-3	242	MOS-1	242
	2136	-19-	NE-3P	242	VOL-3	242
	2137	-19-	NE-3P1	242		
	2138	-19-	NE-3P2	242		
	2140	-19-				
	408	-19-				
	412	-19-				
	426	-19-				
	427	-19-				
	2141 ALEKO	-19-	LA-3D	241	LA-3D	241
			LA-3DP	242	LA-3DP	242
	VARIOUS MODELS	-	NE-3D	242	NE-3D	242

FOR: PARA:	MODEL MODELO			PAG.		PAG.
NISSAN ®	200 SX	-1983	DAT-12	244	DAT-12	244
	240 Z	-1983	DAT-6	243	DAT-6	243
	280 Z	-1983	DAT-6P	243	DAT-6P	243
	300 L	-1983	DAT-7	243	DAT-7	243
	300 ZX	-1983	DAT-7P	243	DAT-7P	243
	AUSTER	-1983				
	AXXESS	-1983				
	BLUEBIRD	-1983				
	CEDRIC	-1983				
	CHERRY	-1983				
	EXA	-1983				
	FAIRLADY	-1983				
	GAZELLE	-1983				
	GLORIA	-1983				
	LANGLEY	-1983				
	LAUREL	-1983				
	LEOPARD	-1983				
	LIBERTA VIL.	-1983				
	MARCH	-1983				
	MAXIMA	-1983				
	MICRA	-1983				
	PAO	-1983				
	PINTARA	-1983				
	PRAIRE	-1983				
PRESIDENT	-1983					
PULSAR	-1983					

FOR: PARA:	MODEL MODELO			PAG.		PAG.
NISSAN ®	SENTRA	-1983				
	SILVIA	-1983				
	SKYLINE	-1983				
	STANZA	-1983				
	SUNNY	1983-1989				
	TULIP	-1983				
	VANETTE	-1983				
	VIOLET	-1983				
	240 Z	1969-1973	DAT-5D	242	DAT-1D	242
	280 Z	1969-1973			DAT-1DP	242
	BLUEBIRD	1977-1979				
	CHERRY	1977-1979				
	SENTRA	1977-1979				
	SKYLINE	1977-1979				
	SUNNY	1977-1979				
	VIOLET	1977-1979				
	240 Z	1974-1983	DAT-5D	242	DAT-2D	242
	260 Z	1974-1983			DAT-2DP	242
	280 Z	1974-1983			DAT-2I	242
	280 ZX ST.W	1974-1983			DAT-2IP	242
	1200 DE LUXE	-1971			DAT-4I	242
	1200 VAN	-1971				
	1200 DE LUXE	1971-1972	DAT-8	243	DAT-7	243
			DAT-8P	243	DAT-7P	243
	BLUEBIRD	1970-1976	DAT-5D	242	DAT-8	243
	CHERRY	1970-1976			DAT-8I	243
	SENTRA	1970-1976			DAT-8IP	243
	SKYLINE	1970-1976			DAT-8IP1	243
	SUNNY	1970-1976			DAT-8P	243
	VIOLET	1970-1976				
	BLUEBIRD	1976-1979	DAT-1D	242	DAT-1D	242
			DAT-1DP	242	DAT-1DP	242
			DAT-1I	242	DAT-1I	242
			DAT-1IP	242	DAT-1IP	242
	BLUEBIRD	1980-1982	DAT-9D	243	DAT-9D	243
			DAT-9DP	243	DAT-9DP	243
			DAT-9I	243	DAT-9I	243
			DAT-9IP	243	DAT-9IP	243
	CEDRIC	1995-1997	DAT-15	244	DAT-15	244
	GLORIA	1995-1997	DAT-15P	244	DAT-15P	244
	PATHFINDER	1996-1997	DAT-16	244	DAT-16	244
	CHERRY	1980-1982	NE-1I	245	DAT-1D	242
			NE-1IP	245	DAT-1DP	242
					DAT-1I	242
				DAT-1IP	242	
FLORIDA	1989-1991	DAT-6	243	DAT-6	243	
PATROL 4x4	1986-	DAT-6P	243	DAT-6P	243	
SUNNY	1989-1991					
TERRANO	1989-1995					
TRADE	1989-					
JUKE	2010-2014	KRCDAT-15	365	KRCDAT-15	365	
KING CAB	2008-2011					
MICRA	2010-2014					
MAXIMA	1980-1982	DAT-2D	242	DAT-2D	242	
		DAT-2DP	242	DAT-2DP	242	
		DAT-2I	242	DAT-2I	242	
		DAT-2IP	242	DAT-2IP	242	

FOR: PARA:	MODEL MODELO			PAG.		PAG.
NISSAN ®	MAXIMA	1991-1995	DAT-10	243	DAT-7	243
			DAT-10P	243		
	MICRA	1993-1995	DAT-10	243	DAT-10	243
	PRIMERA	1991-1995	DAT-10P	243	DAT-10P	243
	TERRANO	1995-				
	TERRANO II	1993-1995				
	MICRA	2002-2010	DAT-15C2	356	DAT-15C2	356
	NOTE	2005-2012				
	PATHFINDER	2005-2012				
	QASHQAI	2007-2013				
	X-TRAIL	2004-2013				
	PATHFINDER	1991-	DAT-12	244	DAT-12	244
	SENTRA	1991-				
	PATROL 4 WD	-1985	DAT-8	243	DAT-8	243
			DAT-8P	243	DAT-8P	243
	QUEST	1993-	FO-8D	244	FO-8D	244
			FO-8DP	244	FO-8DP	244
			FO-8DP1	245	FO-8DP1	245
	QUEST	1993-1994	DAT-19	244	DAT-19	244
			DAT-19P	244	DAT-19P	244
	QUEST	1996-	DAT-20	244	DAT-20	244
			DAT-20P	244	DAT-20P	244
	SERENA	1993-1996	DAT-6	243	DAT-6	243
			DAT-6P1	243	DAT-6P1	243
URVAN	-1994	DAT-12	244	DAT-12	244	
				DAT-1D	242	
				DAT-1DP	242	
VANETTE	1983-1996	DAT-12	244	DAT-12	244	
		DAT-6	243	DAT-6	243	
		DAT-6P	243	DAT-6P	243	
VARIOUS MODELS	-	DAT-11	243	DAT-11	243	
		DAT-11D	243	DAT-11D	243	
		DAT-11DP	243	DAT-11DP	243	
		DAT-11P	244	DAT-11P	244	
		DAT-13	244	DAT-13	244	
		DAT-13P	244	DAT-13P	244	
		DAT-14	244	DAT-14	244	
		DAT-14P	244	DAT-14P	244	
		DAT-15C1	356	DAT-15C1	356	
		DAT-15P4	244	DAT-15P4	244	
		DAT-17	244	DAT-17	244	
		DAT-17D	244	DAT-17D	244	
		DAT-18	244	DAT-18	244	
		DAT-3D	242	DAT-3D	242	
		DAT-3I	242	DAT-3I	242	
		DAT-4D	242	DAT-4D	242	
		DAT-6D	243	DAT-6D	243	
		DAT-6DP	243	DAT-6DP	243	
NISSAN (AUSTRALIA) ®	350Z	2002-2005	KRCDAT-15	365	KRCDAT-15	365
	MURANO	2005-2008				
	PATHFINDER	2002-2005				
	TIIDA	2005-2013				
	X-TRAIL	2004-2007				
	PINTARA	-1983	DAT-12	245	DAT-12	245
	PULSAR	-1983	DAT-6	245	DAT-6	245

FOR: PARA:	MODEL MODELO			PAG.		PAG.	
NISSAN (AUSTRALIA) ®			DAT-6P	245	DAT-6P	245	
			DAT-7	245	DAT-7	245	
			DAT-7P	245	DAT-7P	245	
	NISSAN (USA) ®	350Z	2003-2008	KRCDAT-15	365	KRCDAT-15	365
		ALTIMA	2002-2004				
		ALTIMA	2005-2006				
		ARMADA	2004-2008				
		ARMADA	2009-2012				
		CUBE	2009-2014				
		FRONTIER	2005-2005				
		FRONTIER	2014-2014				
		JUKE	2011-2012				
	MAXIMA	2001-2001					
	MAXIMA	2002-2003					
	MAXIMA	2004-2006					
	MURANO	2003-2007					
	NV	2012-2012					
	NV	2013-2015					
	PATHFINDER	1999-2001					
	PATHFINDER	2002-2004					
	PATHFINDER	2005-2012					
	QUEST	2004-2010					
	ROGUE	2008-2016					
	SENTRA	2000-2004					
	SENTRA	2007-2012					
	TIIDA	2013-2016					
	VERSA	2007-2009					
	VERSA	2010-2012					
	XTERRA	2001-2001					
	XTERRA	2002-2004					
	XTERRA	2005-2011					
	XTERRA	2012-2015					
	810	1980-1982	DAT-2D	245	DAT-2D	245	
			DAT-2DP	245	DAT-2DP	245	
			DAT-2I	245	DAT-2I	245	
			DAT-2IP	245	DAT-2IP	245	
	810	1983-	DAT-12	246	DAT-12	246	
			DAT-6	245	DAT-6	245	
			DAT-6P	246	DAT-6P	246	
			DAT-7	245	DAT-7	245	
			DAT-7P	246	DAT-		

Automóvil. Camioneta  
Automobila. Kamioneta  
Voiture. Camionnette

Auto. Kleintransporter  
Automóvil. Camioneta  
Automóvil. Camioneta

FOR: PARA:	MODEL MODELO			PAG.		PAG.
OM IVECO ®	75.10				IMS-5P	247
	79.10					
	79.13					
	100.13	-19-	AF-8D	246	IMS-3	246
	160.26	-19-	AF-8DP	246	IMS-3P	247
	160	-19-	AF-8I	246	IMS-5	246
			AF-8IP	246	IMS-5P	247
			AF-9D	246		
			AF-9DP	246		
			AF-9I	246		
		AF-9IP	246			
	100.13	-1978	AF-9D	246	IMS-3	246
	110.110P	-1978	AF-9DP	246	IMS-3P	247
	110.13	-1978	AF-9I	246	IMS-5	246
	130	-1978	AF-9IP	246	IMS-5P	247
			FEM-ID	246		
			FEM-II	246		
	130 R	-19-	FEM-ID	246	IMS-3	246
	130 R/H	-19-	FEM-II	246	IMS-3P	247
	130 T/H	-19-			IMS-5	246
	130	-19-			IMS-5P	247
	150 R20	-19-	AF-9D	246	FI-5D	246
	150 T20	-19-	AF-9DP	246	FI-5I	246
	150.20	-19-	AF-9I	246	IMS-3	246
	159.20	-19-	AF-9IP	246	IMS-3P	247
	190 T30	-19-			IMS-5	246
	190.30	-19-			IMS-5P	247
	190.35	-19-	AF-7I	246	IMS-3	246
			IMS-12	247	IMS-12	247
	190.38	-19-	AF-7IP	246	IMS-3P	247
			IMS-3	246	IMS-3	246
			AF-9D	246	IMS-5	246
			IMS-3P	247	IMS-3P	247
			AF-9DP	246	IMS-5P	247
			AF-9I	246		
			AF-9IP	246		
			IMS-5	246	IMS-5	246
			IMS-5P	247	IMS-5P	247
	190.38 TUR.	-19-	AF-7I	246	IMS-3	246
			AF-7IP	246	IMS-3P	247
			AF-9D	246	IMS-5	246
			AF-9DP	246	IMS-5P	247
			AF-9I	246		
			AF-9IP	246		
	330.26	-19-	VO-VB	247	IMS-3	246
	330.35	-19-	VO-VBP	247	IMS-3P	247
					IMS-5	246
					IMS-5P	247
	40	-19-	AF-9D	246	AF-5D	246
			AF-9DP	246	AF-5I	246
			AF-9I	246	AF-6D	246
			AF-9IP	246	AF-6I	246
	75	-19-	AF-9D	246	FI-5D	246
			AF-9DP	246	FI-5I	246
			AF-9I	246	IMS-3	246
			AF-9IP	246	IMS-3P	247
			FEM-ID	246	IMS-5	246

FOR: PARA:	MODEL MODELO			PAG.		PAG.	
OM IVECO ®			FEM-II	246	IMS-5P	247	
		DAINO 145	-19-	BH-4	246	AF-5D	246
		LUPETTO	-19-			AF-5I	246
						AF-6D	246
						AF-6I	246
		GRINTA	-19-	AF-7I	246	IMS-3	246
				AF-7IP	246	IMS-3P	247
				FI-9I	246	IMS-5	246
				FI-9IP	246	IMS-5P	247
				LF-RO	247		
			LF-ROP	247			
	LEONCINO	-19-	BH-4	246	AF-4D	246	
					AF-4I	246	
	ORSETTO	-19-	FEM-ID	246	AF-5D	246	
			FEM-II	246	AF-5I	246	
					AF-6D	246	
					AF-6I	246	
OPEL-VAUXHALL ®	ADAM	2013-2016	KRCOP-II	365	KRCOP-II	365	
	ASTRA	2009-2015					
	CASCADA	2013-2017					
	INSIGNIA	2008-2017					
	MOKKA	2012-					
	ZAFIRA	2013-					
	ADMIRAL	-1973	OP-6	248	OP-6	248	
	KADETT	-1973	OP-7	248	OP-7	248	
	OLIMPIYA	-1973	OP-8	248	OP-8	248	
	REKORD	-1973	OP-9	248	OP-9	248	
		OP-BB	248	OP-BB	248		
		OP-EE	248	OP-EE	248		
		OP-FF	248	OP-FF	248		
ANTARA	-2012	KRCDAE-4	365	KRCDAE-4	365		
ASCONA	-1974	OP-HA	248	OP-HA	248		
MANTA	-1974	OP-HB	248	OP-HB	248		
		OP-HG	249	OP-HG	249		
		OP-HH	249	OP-HH	249		
ASCONA	1975-1981	OP-AB	248	OP-AB	248		
MANTA	1975-1981	OP-ABP	248	OP-ABP	248		
		OP-BA	248	OP-BA	248		
		OP-BAP	248	OP-BAP	248		
		OP-J	249	OP-J	249		
		OP-JP	249	OP-JP	249		
ASCONA	1982-	OP-WHP	249	OP-WHP	249		
CALIBRA	1987-1995	OP-WYP	249	OP-WYP	249		
CARAVAN	1992-						
COMMODORE	1982-						
MANTA	1982-						
MONZA	1984-						
OMEGA	1987-1995						
REKORD	1984-						
VECTRA	1987-1995						
ASTRA	1991-1995	OP-D	248	OP-D	248		
		OP-DP	248	OP-DP	248		
		OP-S	248	OP-S	248		
		OP-SP	248	OP-SP	248		
ASTRA	1998-2004	KRCOP-S	365	KRCOP-S	365		
ZAFIRA	2001-2005						

FOR: PARA:	MODEL MODELO			PAG.		PAG.
OPEL-VAUXHALL ®	ASTRA VAN	1991-1995	OP-D	248	OP-D	248
	COMBO	-19-	OP-DP	248	OP-DP	248
	CORSA	1984-1995	OP-D	248	OP-D	248
	CORSA VAN	1984-1995	OP-DP	248	OP-DP	248
	KADETT	1984-	OP-S	248	OP-S	248
			OP-SP	248	OP-SP	248
	FRONTERA	1992-1996	GM-4	247	GM-4	247
	MONTERREY	1992-	GM-4P	247	GM-4P	247
			GM-4P1	247	GM-4P1	247
	KADETT	1973-1983	OP-AB	248	OP-AB	248
		OP-ABP	248	OP-ABP	248	
		OP-BA	248	OP-BA	248	
		OP-BAP	248	OP-BAP	248	
		OP-J	249	OP-J	249	
		OP-JP	249	OP-JP	249	
MANTA 1.8	1975-1979	OP-J	249	OP-J	249	
		OP-JP	249	OP-JP	249	
MIDI	1992-	MIT-3	248	MIT-3	248	
		MIT-3P	248	MIT-3P	248	
MONZA	1974-1981	OP-R	249	OP-R	249	
REKORD	1974-1984	OP-RP	249	OP-RP	249	
SENATOR	1984-	OP-T	249	OP-T	249	
		OP-TP	249	OP-TP	249	
MONZA	1981-1984	GM-9	247	OP-R	249	
SENATOR	1981-1984	GM-9P	248	OP-RP	249	
		GM-J	248	OP-T	249	
		GM-JP	248	OP-TP	249	
TIGRA	1994-	OP-SP1	249	OP-SP1	249	
VARIOUS MODELS	-	DAC-4DP	247	DAC-4DP	247	
		DAC-5C1	356	DAC-5C1	356	
		DAC-6DP	247	DAC-6DP	247	
		HU-SR	248	HU-SR	248	
		NE-60C1	356	NE-60C1	356	
		NE-60C3	356	NE-60C3	356	
		OP-CC	248	OP-CC	248	
		OP-NA	248	OP-NA	248	
		OP-NB	248	OP-NB	248	
		OP-WHC1	356	OP-WHC1	356	
VARIOUS MODELS	2003-2019	OP-11C1	356	OP-11C1	356	
VARIOUS MODELS	2010-	OP-11C3	356	OP-11C3	356	
PEUGEOT ®	104	1972-	LMP-1	250	VA-6	253
			LMP-1P	250	VA-6P	253
			NE-4	250		
			NE-4P	250		
			NE-4P1	251		
	104	1978-	NE-4	250	NE-4	250
			NE-4P	250	NE-4P	250
			NE-4P1	251	NE-4P1	251
			LAS-V	250	LAS-V	250
	104	1979-	LMP-2	250	LAS-V	250
		LMP-2P	250	VA-6	253	
		NE-4	250	VA-6P	253	
		NE-4P	250			

FOR: PARA:	MODEL MODELO			PAG.		PAG.
PEUGEOT ®			NE-4P1	251		
	104	1980-	CHR-3	249	CHR-3	249
			CHR-3P	249	CHR-3P	249
			LAS-V	250	LAS-V	250
			VA-6	253	VA-6	253
			NE-22P1	251	NE-22P1	251
			VA-6P	253		
	104	1981-	LMP-4	250	LMP-4	250
			LMP-4P	250	LMP-4P	250
			LMP-5	250	LMP-5	250
		LMP-5P	250	LMP-5P	250	
		LAS-V	250	LAS-V	250	
		VA-6	253	VA-6	253	
		VA-6P	253	VA-6P	253	
		FAR-ID	249	FAR-ID	249	
		FAR-II	249	FAR-II	249	
		FAR-2D	249	FAR-2D	249	
		FAR-2I	249	FAR-2I	249	
104	1982-	CHR-3	249	CHR-3	249	
		VA-18	253	VA-18	253	
305	1983-1987	CHR-3P	249	CHR-3P	249	
		NE-22P1	251	NE-22P1	251	
106	1991-1997	NE-36	251	NE-36	251	
		NE-36P1	251	NE-36P1	251	
106 SERVICE	-1993	NE-19	251	NE-19	251	
205 SERVICE	-1993	NE-20P1	251	NE-20P1	251	
107	2004-2014	CIT-1C1	356	CIT-1C1	356	
2008	2012-2016	KRCHU-HAA	365	KRCHU-HAA	365	
204	1965-	NE-37	252	VA-6	253	
304	1969-1978	NE-37P	252	VA-6P	253	
404	1965-	NE-4	250			
504 BERLINA	1968-1974	NE-4P	250			
		NE-4P1	251			
205	1984-	NE-20	251	NE-20	251	



Automóvil. Camioneta  
Automobila. Kamioneta  
Voiture. Camionnette

Auto. Kleintransporter  
Automóvil. Camioneta  
Automóvil. Camioneta

FOR: PARA:	MODEL MODELO			PAG.		PAG.
PEUGEOT®	807	2005-2009				
	807	2009-2014				
	EXPERT	2007-2009				
	EXPERT	2009-				
	305	1978-1980	CHR-3	249	CHR-3	249
			CHR-3P	249	CHR-3P	249
			LAS-V	250	LAS-V	250
			VA-6	253	VA-6	253
			VA-6P	253	VA-6P	253
			PJ-K	252	PJ-K	252
			PJ-KP	252	PJ-KP	252
			NE-22P1	251	NE-22P1	251
	305	1981-1982	SIX-1	252	SIX-1	252
			SIX-1P1	252	SIX-1P1	252
			LAS-V	250	LAS-V	250
			PJ-K	252	PJ-K	252
			PJ-KP	252	PJ-KP	252
	305 SERVICE	1983-	CHR-3	249	CHR-3	249
			NE-22P1	251	NE-22P1	251
			VA-18	253	VA-18	253
	306	1993-1997	NE-20P2	251	NE-20P2	251
			NE-36	251	NE-36	251
	309	1985-	NE-20	251	NE-20	251
	405	1987-1991	NE-20P1	251	NE-20P1	251
			NE-29	251	NE-29	251
			NE-29P	251	NE-29P	251
	309 SERVICE	1985-	NE-19	251	NE-19	251
	405 AFFAIRE	1987-1991	NE-20P1	251	NE-20P1	251
	406	1995-1997	NE-51P2	252	NE-51P2	252
	407	2004-2008	KRCCIT-1	365	KRCCIT-1	365
	508	2010-2014				
	PARTNER	2008-2013				
	504	1975-	NE-4	250	NE-4	250
			NE-4P	250	NE-4P	250
			NE-4P1	251	NE-4P1	251
			LAS-V	250	LAS-V	250
	504 BREAK	1968-1974	NE-4	250	RO-11D	252
			NE-4P	250		
			NE-4P1	251		
	504 PICK UP	1975-	NE-4	250	NE-4	250
			NE-4P1	251	NE-4P1	251
	505	1979-1980	CHR-3	249	CHR-3	249
			CHR-3P	249	CHR-3P	249
			NE-22P1	251	NE-22P1	251
			LAS-V	250	LAS-V	250
			VA-6	253	VA-6	253
			VA-6P	253	VA-6P	253
	505	1984-	NE-20	251	NE-20	251
			NE-20P	251	NE-20P	251
			VA-6	253	VA-6	253
			VA-6P	253	VA-6P	253
	505	1985-	NE-20	251	NE-20	251
			NE-20P1	251	NE-20P1	251
			NE-29	251	NE-29	251
			VA-18	253	VA-18	253
	505 BERLINA	1981-1983	LMP-4	250	LMP-4	250
			LMP-4P	250	LMP-4P	250

FOR: PARA:	MODEL MODELO			PAG.		PAG.
PEUGEOT®			LMP-5	250	LMP-5	250
			LMP-5P	250	LMP-5P	250
			LAS-V	250	LAS-V	250
			VA-6	253	VA-6	253
			VA-6P	253	VA-6P	253
	505 BREAK	1981-1983	CHR-3	249	CHR-3	249
			CHR-3P	249	CHR-3P	249
			NE-22P1	251	NE-22P1	251
			LAS-V	250	LAS-V	250
	505 SERVICE	1979-	CHR-3	249	LAS-R	250
			NE-22P1	251	LAS-V	250
	604	1975-1980	NE-4	250	NE-4	250
			NE-4P	250	NE-4P	250
			NE-4P1	251	NE-4P1	251
			LAS-V	250	LAS-V	250
	604	1981-	CHR-3	249	CHR-3	249
			CHR-3P	249	CHR-3P	249
			NE-22P1	251	NE-22P1	251
			VA-6	253	VA-6	253
			VA-6P	253	VA-6P	253
	605	1990-	NE-34P	251	NE-34P	251
	806	1994-	SIX-3P1	252	SIX-3P1	252
	EXPERT	1995-1996				
	J-5	-19-	FI-12	249	FI-12	249
			FI-12P3	250	FI-12P3	250
			FI-3D	249	FI-3D	249
			FI-3DP3	250	FI-3DP3	250
			FI-6I	250	FI-6I	250
			FI-6IP3	250	FI-6IP3	250
	J-7	-19-	NE-4	250		
			NE-4P1	251		
	J-9	-19-	NE-4	250	RO-4D	252
			NE-4P1	251	RO-4I	252
					RO-5D	252
					RO-5I	252
	PARTNER	1997-	SIX-3P1	252	SIX-3P1	252
	RANCH	1997-	SIX-3P2	252	SIX-3P2	252
	VARIOUS MODELS	-	CHR-4I	249	CHR-4I	249
			CHR-4D	249	CHR-4D	249
			HU-HCAP	250	HU-HCAP	250
			NE-4D	250	NE-4D	250
			NE-4P2	251	NE-4P2	251
			NE-60C2	356	NE-60C2	356
			PEU-2C1	357	PEU-2C1	357
			RO-11I	252	RO-11I	252
			RO-14	252	RO-14	252
			RO-1D	252	RO-1D	252
			RO-1DS	249	RO-1DS	249
			RO-1I	252	RO-1I	252
			RO-1IS	249	RO-1IS	249
			RO-2D		RO-2D	
			RO-2I		RO-2I	
			RO-6D	252	RO-6D	252
			RO-6I	252	RO-6I	252
			RO-8I		RO-8I	
			NE-36P	251	NE-36P	251
			NE-39P	252	NE-39P	252

FOR: PARA:	MODEL MODELO			PAG.		PAG.
PEUGEOT®	VARIOUS MODELS	2004-2018	PEU-1C1	356	PEU-1C1	356
	VARIOUS MODELS	2005-	NE-60C3	356	NE-60C3	356
PEUGEOT (ARGEN.)®	VARIOUS BRANDS	-	NE-4D	253	NE-4D	253
PEUGEOT (ARGEN.)®	404	-19-	NE-3	253	NE-43	254
			GAS-1	253	GAS-1	253
			NE-43	254	NE-43	254
			NE-3P	253		
			NE-3P2	253		
	405	-19-	NE-20	253	NE-20	253
			NE-20P1	254	NE-20P1	254
	504	-19-	NE-3	253	NE-3	253
			GAS-1	253	GAS-1	253
			NE-43	254	NE-43	254
			NE-3P	253	NE-3P	253
			NE-3P2	253	NE-3P2	253
			NE-4	253	NE-4	253
			NE-4P	253	NE-4P	253
	504 PICK UP	-19-	NE-4	253	NE-4	253
			NE-4P	253	NE-4P	253
			GAS-1	253	GAS-1	253
			NE-43	254	NE-43	254
			NE-20	253	NE-20	253
			NE-20P1	254	NE-20P1	254
			NE-42	254	NE-42	254
			NE-42P	254	NE-42P	254
			NE-42P1	254	NE-42P1	254
			NE-53	254	NE-53	254
PIAGGIO®	PORTER	1993-1994	DAI-1P	254	DAI-1P	254
PLYMOUTH®	ACCLAIM	1990-1992	CHR-9	254	CHR-9	254
	PLYMOUTH	1990-	CHR-9P	254	CHR-9P	254
	ACCLAIM	1993-	CHR-10	254	CHR-10	254
	GRAN VOYAGER	1993-	CHR-10P	254	CHR-10P	254
	VOYAGER	1993-				
	COLT VISTA	1989-1992	CHR-17	255	CHR-17	255
	LASER	1989-1992				
	COLT VISTA	1993-1994	MIT-13D	255	MIT-13D	255
			MIT-14D	255	MIT-14D	255
	NEON	1995-	CHR-14	254	CHR-14	254
			CHR-14P	255	CHR-14P	255
			CHR-15	255	CHR-15	255
			CHR-15P	255	CHR-15P	255
	PLIMOUTH	1985-1986	CHR-7	254	CHR-7	254
			CHR-7P	254	CHR-7P	254
	PLIMOUTH	1986-1990	CHR-8	254	CHR-8	254
			CHR-8P	254	CHR-8P	254
	SUNDANCE	1989-	CHR-8	254	CHR-8	254
			CHR-8P	254	CHR-8P	254
	VARIOUS MODELS	-	CHR-14P	255	CHR-14P	255
	VOYAGER	1991-1992	CHR-8	254	CHR-8	254
			CHR-8P	254	CHR-8P	254

FOR: PARA:	MODEL MODELO			PAG.		PAG.
PONTIAC®	AZTEK	2001-2005	KRCGM-28	365	KRCGM-28	365
	BONNEVILLE	2001-2005				
	MONTANA	2007-2009				
	G5	2007-2010	KRCGM-37	366	KRCGM-37	366
	G6	2006-2010				
	GRAND PRIX	2004-2004				
	GRAND PRIX	2006-2008				
	MONTANA	2005-2006				
	SOLSTICE	2006-2006				
	SOLSTICE	2007-2009				
	TORRENT	2007-2009				
	GRAND PRIX	2001-2003	KRCGM-43	366	KRCGM-43	366
	MONTANA	1999-2000	KRCGM-27	365	KRCGM-27	365
	MONTANA	2001-2004				
	MONTANA	2005-2005				
	TRANS SPORT	1997-1998				
PORSCHE®	911 CARRERA	1970-	PO-HC	255	PO-HC	255
	912	1970-	PO-HCP	255	PO-HCP	255
	914	1970-	PO-NC	255	PO-NC	255
			PO-NCP	255	PO-NCP	255
	924	1975-1993	VO-HV	255	VO-HV	255
	944	1975-1993	VO-HVP			

Automóvil. Camioneta  
Automobila. Kamioneta  
Voiture. Camionnette

Auto. Kleintransporter  
Automóvil. Camioneta  
Automóvil. Camioneta

FOR: PARA:	MODEL MODELO			PAG.		PAG.
RENAULT (ARGEN.)®	NEVADA	-19-	CHR-3	260	NE-28	261
			NE-22P	261		
	R 4	-19-	NE-3	261	NE-3	261
			NE-3P	261	NE-3P	261
			NE-3P2	261	NE-3P2	261
			NE-4	261	NE-4	261
			NE-4P	261	NE-4P	261
			NE-4P2	261	NE-4P2	261
			GAS-1	261	GAS-1	261
	R 6	-19-	NE-3	261	NE-3	261
			NE-3P	261	NE-3P	261
			NE-3P2	261	NE-3P2	261
	R 9	-19-	NE-22P	261	NE-16	261
			NE-55P	262	NE-55P	262
	R11	-19-	CHR-3	260	NE-16	261
	R18	-19-	NE-22P	261	NE-55P	262
			NE-55P	262	NE-59P	262
	R12	-19-	CHR-3	260	CHR-3	260
			NE-22P	261	NE-22P	261
			NE-4	261	NE-4	261
			NE-4P	261	NE-4P	261
		NE-4P2	261	NE-4P2	261	
		NE-43	262	NE-43	262	
		GAS-1	261	GAS-1	261	
R19	-19-	NE-36	261	NE-36	261	
		NE-36P1	261	NE-36P1	261	
R21	-19-	CHR-3	260	NE-28	261	
		NE-22P	261	VA-10	262	
		NE-55P	262			
TRAFFIC	-19-	CHR-3	260	NE-16	261	
		NE-22P	261	NE-53	262	
		NE-55P	262	NE-59P	262	
RENAULT®	R 4	1961-1991	NE-4	258	NE-4	258
			NE-4P	258	NE-4P	258
			NE-4P1	258	NE-4P1	258
			NE-4P2	258	NE-4P2	258
R 5	1972-1979	LMP-2	257	RO-15	260	
		LMP-2P	257	VA-7	260	
		FAB-1	257	FAB-1	257	
		NE-15D	258			
		NE-15DP	258			
		NE-15I	258			
		NE-15IP	258			
R 5	1979-	NE-15D	258	NE-16	258	
		NE-15DP	258	NE-59P	260	
		NE-15I	258			
		NE-15IP	258			
R 5	1980-	CHR-3	257	NE-16	258	
		CHR-3P	257	NE-59P	260	
		LMP-4	258			
		LMP-4P1	258			
R 5	1981-	CHR-3	257	VA-10	260	
		CHR-3P	257			
R 5	1982-	CHR-3	257	VA-10	260	
		CHR-3P	257			
		BL-2	257	BL-2	257	

FOR: PARA:	MODEL MODELO			PAG.		PAG.
RENAULT®			LAS-V	257	LAS-V	257
			LMP-4	258		
			LMP-4P1	258		
			LMP-5	258		
			LMP-5P1	258		
	R 5	1983-1984	CHR-3	257	VA-10	260
			CHR-3P	257		
	R 5	1985-1986	NE-19	259	VA-10	260
			NE-19P1	259		
	R 5	1986-	NE-19	259	NE-28	259
			NE-19P1	259		
	R 6	1968-	LMP-1	257	RO-15	260
			LMP-1P	257		
			NE-15I	258		
			NE-15IP	258		
	R 7	-19-	NE-15I	258	NE-16	258
			NE-15IP	258	NE-4	258
			NE-4	258	NE-4P2	258
			NE-4P2	258	NE-59P	260
			FAR-1D	257	FAR-1D	257
	R 9	-19-	NE-55P	260		
R 11	-19-					
R 12	-19-					
R 21 NEVADA	-19-					
FUEGO	-19-					
TRAFFIC	-19-					
R 9	1981-	CHR-3	257	NE-16	258	
R 11	1981-	CHR-3P	257	NE-59P	260	
		LMP-5	258			
		LMP-5P1	258			
R 9	1982-1983	CHR-3	257	BS-5	257	
R 11	1982-1983	CHR-3P	257	NE-16	258	
				NE-59P	260	
				VA-10	260	
R 9	1984-	NE-19	259	NE-16	258	
		VA-17P	260	VA-17P	260	
R 11	1984-	NE-19P	259	NE-59P	260	
				VA-10	260	
				VA-17P	260	
R 12	1969-1971	LMP-1	257	RO-15	260	
		LMP-1P	257			
R 12	1972-	LMP-2	257	VA-7	260	
		LMP-2P	257			
R 14	1976-1977	CHR-3	257	NE-16	258	
		CHR-3P	257	NE-59P	260	
		NE-15I	258			
		NE-15IP	258			
R 14	1978-1979	CHR-3	257	VA-7	260	
		CHR-3P	257			
R 14	1980-	CHR-3	257	NE-16	258	
		CHR-3P	257	NE-59P	260	
		LMP-4	258	VA-10	260	
		LMP-4P1	258			
R 15	1971-	NE-15I	258	RO-15	260	
R 17	1971-	NE-15IP	258			

FOR: PARA:	MODEL MODELO			PAG.		PAG.
RENAULT®	R 16	1965-	NE-3	258	RO-15	260
			NE-3P1	258		
			NE-3P2	258		
	R 18	1978-1980	CHR-3	257	NE-16	258
	FUEGO	1978-1980	CHR-3P	257	NE-59P	260
	R 18	1980-1982	CHR-3	257	VA-10	260
	FUEGO	1982-	CHR-3P	257		
			LMP-5	258		
			LMP-5P1	258		
	R 18	1983-	CHR-3	257	VA-10	260
			CHR-3P	257		
			NE-19	259		
			NE-19P1	259		
			NE-22P	259		
			NE-55P	260		
	R 19	1988-1990	NE-19	259	NE-19	259
			NE-19P1	259	NE-19P1	259
			VA-10	260	VA-10	260
	R 19	1990-	NE-19	259	NE-19	259
			NE-19P1	259	NE-19P1	259
			NE-36	259	NE-36	259
		NE-36P1	259	NE-36P1	259	
R 20	1975-	CHR-3	257	VA-17P	260	
R 30	1975-	CHR-3P	257			
		LMP-4	258			
		LMP-4P1	258			
		NE-22P	259			
R 21	1986-1989	NE-19	259	NE-28	259	
		NE-19P1	259	VA-10	260	
R 21	1990-1991	NE-36	259	NE-36	259	
		NE-36P1	259	NE-36P1	259	
R 21	1992-	NE-38	259	NE-38	259	
R 25	1992-	NE-38P1	259	NE-38P1	259	
SAFRANE	1992-1995					
R 25	1983-1988	NE-19	259	VA-17P	260	
		NE-19P1	259			
R 25	1989-1991	NE-36	259	VA-17P	260	
		NE-36P1	259			
ALPINE	1992-	NE-19	259	NE-19	259	
		NE-19P1	259	NE-19P1	259	
CLIO	1990-1998	NE-36	259	NE-36	259	
		NE-36P1	259	NE-36P1	259	
		VA-34	260	VA-34	260	
		VA-34P	260	VA-34P	260	
		VA-34P1	260	VA-34P1	260	
		VA-34P2	260	VA-34P2	260	
CLIO II	2001-2008	KRCNE-36	366	KRCNE-36	366	
CLIO III	2006-2010	KRCCIT-1	366	KRCCIT-1	366	
MODUS	2004-2012					
COACH	1995-1996	NE-38	259	NE-38	259	
MEGANE	1995-1996	NE-38P1	259	NE-38P1	259	
ESPACE	1984-1997	NE-19	259	VA-10	260	
		NE-19P1	259			
		NE-36	259			
		NE-36P1	259			
KANGOO	1998-2010	VA-34P	260	VA-34P	260	
LAGUNA	1994-2001	VA-34P1	260	VA-34P1	260	

FOR: PARA:	MODEL MODELO			PAG.		PAG.
RENAULT®	SAFRANE	1995-2001	VA-34P2	260	VA-34P2	260
	TWINGO	1994-2007				
	LAGUNA	1994-	NE-38	259	NE-38	259
			NE-38P1	259	NE-38P1	259
			VA-34	260	VA-34	260
	LAGUNA 2 <sup>se.</sup>	1994-	VA-34	260	NE-50P	260
	TWINGO	1993-1994	NE-36	259	NE-36	259
	TWINGO	1995-				
	TWINGO	1993-1995	NE-36P	259	NE-36P	259
	VARIOUS MODELS	-	AMM-1	257	AMM-1	257
			NE-15DP1	258	NE-15DP1	258
			NE-3D	258	NE-3D	258
			NE-5	258	NE-5	258
			NE-60C2	357	NE-60C2	357
			RO-11D	260	RO-11D	260
			RO-11I	260	RO-11I	260
			RO-1D	260	RO-1D	260
			RO-1DS	257	RO-1DS	257
			RO-1I	260	RO-1I	260
			RO-1IS	257	RO-1IS	257
			RO-2D		RO-2D	
		RO-2I		RO-2I		
		RO-6D	260	RO-6D	260	
		RO-6I	260	RO-6I	260	
		VA-61C1	357	VA-61C1	357	
		VA-61C2	357	VA-61C2	357	
		VA-61C3	357	VA-61C3	357	
		NE-20P	259	NE-20P	259	
		NE-20P1	259	NE-20P1	259	
		NE-20P2	259	NE-20P2	259	
		NE-20P3	259	NE-20P3	259	
		NE-39P	259	NE-39P	259	
VARIOUS MODELS	2004-	NE-60C3	357	NE-60C3	357	
RENAULT DACIA®	VARIOUS MODELS	-	DAC-3DC1	357	DAC-3DC1	357
			DAC-4DP	262	DAC-4DP	262
			DAC-6DP	262	DAC-6DP	262
			DAC-7DC1	357	DAC-7DC1	357

Automóvil. Camioneta  
Automobila. Kamioneta  
Voiture. Camionnette

Auto. Kleintransporter  
Automóvil. Camioneta  
Automóvil. Camioneta

FOR: PARA:	MODEL MODELO			PAG.		PAG.
<b>RENAULT SAVIEM</b> ®	EXPRESS-B-D	-1987	NE-19	263	NE-19	263
			NE-19P	263	NE-19P	263
			NE-19P1	263	NE-19P1	263
			LAS-R	262	LAS-R	262
			LAS-V	262	LAS-V	262
	EXPRESS-B-D	1987-1991	NE-19	263	NE-28	263
			NE-19P1	263		
	JK 50-60	-19-	BH-1	262	RO-15	264
	JK 75-90	-19-	BH-1P	262	RO-4D	264
	JK 110-115	-19-			RO-4I	264
	JP 11	-19-	BH-1	262	RO-4D	264
			LAS-R	262	LAS-R	262
	JP 13	-19-	BH-1P	262	RO-4I	264
			LAS-V	262	LAS-V	262
	JP 13 TU	-19-				
	JP 115	-19-				
	MASTER P35 D	-1987	CHR-3	262	VA-7	264
			NE-28	263	NE-28	263
	MASTER T30 D	-1987	CHR-3P	262		
	MASTER T35 D	-1987	LMP-5	262		
			LMP-5P1	262		
			NE-22P	263		
	MASTER T30 D	1987-	CHR-3	262	NE-28	263
	MASTER T35 D	1987-	NE-22P	263		
	MASTER TURBO	1987-				
	R 11 CARGO	-1991	NE-19	263	VA-10	264
			NE-19P1	263		
			PJ-1	264	PJ-1	264
			PJ-2	264	PJ-2	264
			PJ-2P	264	PJ-2P	264
R 19 TD	-1992	NE-19	263	NE-19	263	
		NE-19P1	263	NE-19P1	263	
		VA-10	264	VA-10	264	
		RO-7D		RO-7D		
R4 F4 C. 850	-1994	NE-4	263	NE-4	263	
R4 F4 C.1100	-1994	NE-4P	263	NE-4P	263	
		NE-4P2	263	NE-4P2	263	
SUPERCINCO D	-1991	NE-19	263	NE-28	263	
		NE-19P1	263			
TRAFFIC	-1987	CHR-3	262	RO-17	264	
		CHR-3P	262			
		NE-22P	263			
TRAFFIC	1988-	NE-19	263	NE-28	263	
		NE-19P	263			
VARIOUS MODELS	-19-	NE-20P	263	NE-20P	263	
		NE-20P1	263	NE-20P1	263	
		NE-20P2	263	NE-20P2	263	
		NE-20P3	263	NE-20P3	263	
		NE-36	263	NE-36	263	
		NE-36P	264	NE-36P	264	
		NE-36P1	264	NE-36P1	264	
		NE-39P	264	NE-39P	264	
<b>ROLLS ROYCE</b> ®	ALGUNOS-SOME	1995-	YA-20D	264	YA-20D	264
	CLOUD	-1970				
	SHADOW	-1970				

FOR: PARA:	MODEL MODELO			PAG.		PAG.	
<b>ROLLS ROYCE</b> ®	CLOUD	1981-1997	YA-21I	265	YA-21I	265	
	SHADOW	1981-1997					
	SHADOW	1971-1980	YA-21I	265	YA-20D	264	
	SPIRIT	1971-1980			YA-20I	264	
	SPUR	1971-1980					
	VARIOUS MODELS	1970-1973	YA-18D	264	YA-18D	264	
			YA-19D	264	YA-19D	264	
			YA-20I	264	YA-20I	264	
	WRAITH	1971-1980					
	SPIRIT	1980-1983	YA-20I	264	YA-20I	264	
			YA-21I	265	YA-21I	265	
	SPUR	1980-1983	YA-21I	265	YA-21I	265	
	<b>ROVER</b> ®	2000	1976-1981	LF-RO	265	LF-RO	265
				FO-E-TC	265	FO-E-TC	265
	2300	1976-1981	LF-ROP	265	LF-ROP	265	
			FO-E-TC	265	FO-E-TC	265	
2400	1976-1981						
2600	1976-1981	LF-RO	265	LF-RO	265		
		LF-ROP	265	LF-ROP	265		
3500	1976-1981						
2000	1982-1985	LF-RO	265	LF-RO	265		
2200	1982-1985	LF-ROP	265	LF-ROP	265		
		FO-E-TC	265	FO-E-TC	265		
		FO-E-TCP	265	FO-E-TCP	265		
2300	1982-1985	NE-11	265	NE-11	265		
		FO-E-TC	265	FO-E-TC	265		
		FO-E-TCP	265	FO-E-TCP	265		
2400	1982-1985	NE-11P	265	NE-11P	265		
2600	1982-1985						
3500	1982-1985						
2000	1985-	LF-RO	265	LF-RO	265		
2300	1985-	LF-ROP	265	LF-ROP	265		
		FO-E-TC	265	FO-E-TC	265		
		FO-E-TCP	265	FO-E-TCP	265		
2400	1985-	LF-ROP	265	LF-ROP	265		
2600	1985-						
2000 SC/TC	1963-1975	LF-9	265	UN-4	265		
		IN-4	265	IN-4	265		
3500	1963-1975	LF-9	265	UN-4	265		
25	2000-	NE-35P2	266	NE-35P2	266		
3500 V8 S	1976-	LF-9	265	UN-1FS	267		
		LF-RO	265	UN-4	265		
		LF-ROP	265				
		FO-E-TC	265	FO-E-TC	265		
		FO-E-TCP	265	FO-E-TCP	265		
416	1995-1996	NE-35P2	266	NE-35P2	266		
620	1995-1996						
820	1992-1994	NE-52P	266	NE-52P	266		
825	1992-1994						
ALLEGRO	1973-	LF-RO	265	UN-FT	267		
		LF-ROP	265				
		PJ-2	266	PJ-2	266		
		PJ-2P	266	PJ-2P	266		
ALLEGRO 2	1973-	LF-BL	265	UN-FT	267		
		LF-RO	265				
		LF-ROP	265				

FOR: PARA:	MODEL MODELO			PAG.		PAG.
<b>ROVER</b> ®			WAS-1	267	WAS-1	267
	ALLEGRO 3	1973-	LF-BL	265	UN-FT	267
			LF-RO	265		
			LF-ROP	265		
			NE-11	265		
			NE-11P	265		
			WAS-1	267	UN-FT	267
	FX 4S (TAXI)	-19-	LF-BL	265	IN-4	265
			LF-RO	265	IN-5	265
			LF-ROP	265		
			UN-FS	267	UN-FS	267
	MAESTRO	1983-	NE-11	265	NE-11	265
			NE-11P	265	NE-11P	265
			NE-11P1	266	NE-11P1	266
			NE-11P2	266	NE-11P2	266
			NE-24	266	NE-24	266
			NE-24P	266	NE-24P	266
			NE-24P1	266	NE-24P1	266
			PJ-2	266	PJ-2	266
			PJ-2P	266	PJ-2P	266
	MARINA	-19-	LF-BL	265	UN-FT	267
			LF-RO	265		
			LF-ROP	265		
			NE-1	265		
			NE-1P	265		
	MAXI	1969-	NE-1	265	UN-FS	267
	TRAVELLER	1969-	NE-1P	265		
	METRO	1980-1983	NE-11	265	NE-14	266
			NE-11P	265		
	METRO	1984-1989	NE-11	265	NE-14	266
		NE-11P	265			
		PJ-2	266	PJ-2	266	
		PJ-2P	266	PJ-2P	266	
MINI	1959-1973	UN-FS	267	UN-FS	267	
MINI	1974-1984	LF-BL	265	UN-FS	267	
		LF-RO	265			
		LF-ROP	265			
		PJ-2	266	PJ-2	266	
		PJ-2P	266	PJ-2P	266	
MINI	1985-	NE-11	265	UN-FS	267	
		NE-11P1	266			
		NE-11P2	266			
		PJ-K	266	PJ-K	266	
		PJ-KP	267	PJ-KP	267	
MONTEGO	1984-1988	NE-11	265	NE-14	266	
		NE-11P	265			
		NE-24	266			
		NE-24P	266			
		PJ-2	266	PJ-2	266	
		PJ-2P	266	PJ-2P	266	
MONTEGO	1988-1991	NE-11	265	NE-11	265	
		NE-11P1	266	NE-11P1	266	
		NE-11P2	266	NE-11P2	266	
		NE-24	266	NE-24	266	
		NE-24P1	266	NE-24P1	266	
MONTEGO	1992-	NE-35	266	NE-35	266	
		NE-35P	266	NE-35P	266	

FOR: PARA:	MODEL MODELO			PAG.		PAG.
<b>ROVER</b> ®	PRINCESS	-19-	NE-11	265	LF-RO	265
			NE-11P	265	LF-ROP	265
			WAS-1	267	WAS-1	267
	SERIE 100	1991-1993	NE-11	265	NE-11	265
			NE-11P1	266	NE-11P1	266
			NE-11P2	266	NE-11P2	266
	SERIE 200	1984-	HOND-10	265	HOND-10	265
			HOND-10P	265	HOND-10P	265
	SERIE 200	1985-1989	NE-11	265	NE-11	265
	SERIE 800	1987-1991	NE-11P	265	NE-11P	265
			NE-11P1	266	NE-11P1	266
			NE-11P2	266	NE-11P2	266
			NE-24	266	NE-24	266
			NE-24P	266	NE-24P	266
	SERIE 200	1989-1993	NE-35	266	NE-35	266
SERIE 400	1989-1993	NE-35P2	266	NE-35P2	266	
SHERPA 185	-19-	LF-BL	265	UN-1FS	267	
SHERPA 230	-19-	LF-RO	265	UN-FT	267	
SHERPA 255	-19-	LF-ROP	265			
<b>SAAB</b> ®	900	1974-1977	SAA-2P	267	SAA-2P	267
	99	1974-1977				
	900	1978-1993	SAA-AC	267	SAA-AC	267
			SAA-ACP	267	SAA-ACP	267
			WAS-1	267	WAS-1	267
	900	1993-	SAA-1P1	267	SAA-1P1	267
	9000	1986-				
	93	1998-	SAA-1P1	267	SAA-1P1	267
	95	-19-	AS-1D	267	SAA-AC	267
	96	-19-	SAA-AC	267	SAA-ACP	267
			SAA-ACP	267		
<b>SATURN</b> ®	AURA	2007-2010	KRCGM-37	366	KRCGM-37	366
	OUTLOOK	2007-2010		</		

Automóvil. Camioneta  
Automobila. Kamioneta  
Voiture. Camionnette

Auto. Kleintransporter  
Automóvil. Camioneta  
Automóvil. Camioneta

FOR: PARA:	MODEL MODELO			PAG.		PAG.
SEAT ®	132	1973-	AF-7I	267	IMS-3	269
			AF-7IP	268	IMS-3P	269
			FI-8I	268	IMS-5	269
			FI-8IP	268	IMS-5P	269
			FO-FR	269		
			FO-FRP	269		
	ALHAMBRA	2011-2013	KRCHU-HAA	366	KRCHU-HAA	366
	ALTEA	2004-2008				
	ALTEA	2009-2010				
	ALTEA	2011-2013				
	CORDOBA	2003-2009				
	IBIZA	2002-2010				
	IBIZA	2008-2011				
	LEON	2000-2002				
	LEON	2002-2005				
	LEON	2005-2008				
	LEON	2006-2010				
	LEON	2006-2013				
	MII	2012-2013				
	TOLEDO	1999-2001				
	TOLEDO	2002-2004				
	TOLEDO	2005-2009				
	TOLEDO	2009-2010				
	CORDOBA	1993-1995	AU-AH	268	AU-AH	268
	EMELBA	1993-	AU-AHP	268	AU-AHP	268
	IBIZA	1993-1995	SE-AHP	269	SE-AHP	269
	POKER	1993-	VO-2	269	VO-2	269
	TOLEDO	1991-1995	VO-2P	269	VO-2P	269
	EMELBA	1984-1987	CL-6	268	CL-6	268
			AF-5D	267	AF-5D	267
	IBIZA	1984-1987	CL-6P	268	CL-6P	268
			CL-6	268	CL-6	268
	POKER	1984-1987	CL-6P	268	CL-6P	268
			CL-6	268	CL-6	268
	EMELBA	1988-1992	AU-HV	268	AU-HV	268
	IBIZA	1988-1992	CL-9P	268	CL-9P	268
	POKER	1988-1992	VO-HV	269	VO-HV	269
	FURA	1972-1982	CL-7P	268	IMS-3	269
			FI-3D	268	IMS-3P	269
			FI-3DP	268	IMS-5	269
			FI-8I	268	IMS-5P	269
			FI-8IP	268		
			IMS-7	269		
			IMS-7P	269		
	GREDOS (GRE)	-19-	CL-6	268	CL-6	268
	MALAGA	1985-1990	CL-6P	268	CL-6P	268
	MARBELLA	1987-1992	CL-6	268	IMS-3	269
			CL-6P	268	IMS-3P	269
					IMS-5	269
					IMS-5P	269
	MARBELLA	1993-1997	AU-AH	268	AU-AH	268
			AU-AHP	268	AU-AHP	268
			CL-6	268	CL-6	268
			CL-6P	268	CL-6P	268
			SE-AHP	269	SE-AHP	269
			VO-2	269	VO-2	269
			VO-2P	269	VO-2P	269

FOR: PARA:	MODEL MODELO			PAG.		PAG.
SEAT ®	PANDA	1980-1986	FI-8I	268	IMS-3	269
			FI-8IP	268	IMS-3P	269
			FI-9I	268	IMS-5	269
			FI-9IP	268	IMS-5P	269
	RITMO	-19-	CL-7P	268	CL-7P	268
			FI-3D	268	FI-3D	268
			FI-3DP	268	FI-3DP	268
	RONDA	1982-1984	CL-7P	268	CL-7P	268
			FI-3D	268	FI-3D	268
			FI-3DP	268	FI-3DP	268
	RONDA	1985-	CL-6	268	CL-6	268
			CL-6P	268	CL-6P	268
	TERRA	-19-	CL-6	268	IMS-3	269
			CL-6P	268	IMS-3P	269
					IMS-5	269
					IMS-5P	269
	TRANS	-19-	CL-6	268	IMS-3	269
			CL-6P	268	IMS-3P	269
			FI-9I	268	IMS-5	269
			FI-9IP	268	IMS-5P	269
SEAT (AUSTRALIA) ®	ALTEA	2004-2010	KRCHU-HAA	366	KRCHU-HAA	366
SKODA ®	100	1982-1984	SKO-1	269		
	105	1982-1984	SKO-1P			
	110	1982-1984	SKO-2	269		
	120	1982-1984				
	110	1985-	SKO-1	269		
	120	1985-	SKO-1P			
	130	1985-				
	135	1985-				
	ESTELLE	1985-				
	GARD LUXE	1985-				
	RAPIDE	1985-				
	FABIA	2000-2008	KRCHU-HAA	366	KRCHU-HAA	366
	FABIA	2007-2010				
	FABIA	2011-2013				
	GITIGO	2012-2013				
	OCTAVIA	1997-2001				
	OCTAVIA	2004-2008				
	OCTAVIA	2004-2010				
	OCTAVIA	2009-2012				
	OCTAVIA I	1998-1998				
	RAPID	2012-2013				
	ROOMSTER	2006-2010				
	SUPERB	2002-2008				
	SUPERB	2008-2013				
	SUPERB	2009-2013				
	YETI	2010-2013				
	FAVORIT	1987-	SKO-3I	270	SKO-3I	270
	FORMAN	1987-	SKO-3IP	270	SKO-3IP	270
	SILVER	1993-				
	FELICIA	1995-	SKO-5P	270	SKO-5P	270
	PICK-UP	1995-				
	MODELOS	1964-1981	SKO-8	270	SKO-4	270
	VARIOUS MODELS	-	HU-NAAC2	357	HU-NAAC2	357

FOR: PARA:	MODEL MODELO			PAG.		PAG.
SKODA ®			SKO-6	270	SKO-6	270
			SKO-7	270	SKO-7	270
	VARIOUS MODELS	-2020	HU-HAAC1	357	HU-HAAC1	357
			HU-HAAC2	357	HU-HAAC2	357
SMART ®	FORTWO	2005-2015	KRCCIT-1	366	KRCCIT-1	366
SSANGYONG ®	KORANDO	2000-	HY-5	270	HY-5	270
			HY-5P	270	HY-5P	270
	MUSSO	1994-	HY-3P3	270	HY-3P3	270
	MUSSO	1995-	HY-3P2	270	HY-3P2	270
	VARIOUS MODELS	-	SSA-1P1	270	SSA-1P1	270
STERLING ®	SERIE 800	-19-	NE-11	270		
			NE-11P	270		
			NE-24	270		
			NE-24P	270		
STEYR-PUCH ®	19 S31	-1994	NE-58D	272		
	19 S37	-1994				
	26 S31	-1994				
	32 S31	-1994				
	230	-1979	ME-HZ	271	ME-HZ	271
	240	-1979	ME-HZP	272	ME-HZP	272
	280	-1979				
	230	1979-	ME-HF	271	ME-HF	271
	240	1979-	ME-HFP	272	ME-HFP	272
			ME-HM	271	ME-HM	271
	280	1979-	ME-HM	271	ME-HM	271
			ME-HMP	272	ME-HMP	272
	300	1979-	ME-HZ	271	ME-HZ	271
			ME-HZP	272	ME-HZP	272
			HU-SU	271	HU-SU	271
	PANDA 4x4	1983-1985	AF-7I	271	IMS-3	271
			AF-7IP	271	IMS-3P	271
			FI-9I	271	IMS-5	271
			FI-9IP	271	IMS-5P	271
	PANDA 4x4	1986-1988	FI-1	271	IMS-3	271
			FI-11	271	IMS-3P	271
			FI-11P	271	IMS-5	271
			FI-1P	271	IMS-5P	271
	PANDA 4x4	1989-	FI-1	271	FI-1	271
			FI-11	271	FI-11	271
			FI-11P	271	FI-11P	271
			FI-1P	271	FI-1P	271
SUBARU ®	ALCYONE	1986-	DAT-6	272	DAT-6	272
	E10 VAN	1986-	DAT-6D	272	DAT-6D	272
	E12 VAN	1986-	DAT-6DP	272	DAT-6DP	272
	E5 VAN	1986-	DAT-6DP1	272	DAT-6DP1	272
	E7 VAN	1986-	DAT-6P	272	DAT-6P	272
	HUNTER	1986-	DAT-6P1	272	DAT-6P1	272
	JUSTY (EU)	1986-1996				
	L 1.3	1986-				
	L 1.6	1986-				

FOR: PARA:	MODEL MODELO			PAG.		PAG.
SUBARU ®	L 1.8	1986-				
	LEGACY 4WD	1986-1996				
	LEONE	1986-				
	M 70	1986-				
	M 80	1986-				
	SAMBAR VAN	1986-				
	XT	1986-				
	E10 DOMINGO	1984-1985	DAT-11D	273	DAT-8I	273
	JUSTY	1984-1985	DAT-11DP		DAT-8IP	273
	L 1.3	1984-1985	WAS-2P	273	DAT-8IP1	273
	L 1.6	1984-1985				
	L 1.8	1984-1985				
	M 70	1984-1985				
	M 80	1984-1985				
	REX	1984-1985				
	HATCHBACK	1985-	DAT-6	272	DAT-6	272
	JUSTY XT	1985-1996	DAT-6P	272	DAT-6P	272
	LEGACY	1985-1996	DAT-6P1	272	DAT-6P1	272
	LOYALE	1985-	DAT-7	272	DAT-7	272
			DAT-7P	272	DAT-7P	272
	IMPENZA	1995-	DAT-6	272	DAT-6	272
			DAT-6P1	272	DAT-6P1	272
	JUSTY	1991-1996	DAT-6	272	DAT-7	272
			DAT-6P1	272		
	LEONE	1973-1982	DAT-11D	273	DAT-1D	272
	REX	1973-1982	DAT-11DP		DAT-1DP	272
	SEDAN	1973-1982	WAS-2P	273	DAT-1I	272
	TIGRE	1973-1982			DAT-11P	272</



Automóvil. Camioneta  
Automobila. Kamioneta  
Voiture. Camionnette

Auto. Kleintransporter  
Automóvil. Camioneta  
Automóvil. Camioneta

FOR: PARA:	MODEL MODELO			PAG.		PAG.
<b>SUBARU (USA) ®</b>	LIBERTY	2009-2013	KRCSUB-2	366	KRCSUB-2	366
<b>SULKY ®</b>	125	-1991	BH-4	273	ZA-1	274
	50	-1991			ZA-1P	274
<b>SUNBEAM ®</b>	1.0	-19-	LF-SL	274	LF-SL	274
			PJ-2	274	PJ-2	274
	1.3	-19-	LF-SLP	274	LF-SLP	274
			PJ-2P	274	PJ-2P	274
	1.6	-19-	PJ-2	274	PJ-2	274
			LF-SLP	274	LF-SLP	274
			PJ-2P	274	PJ-2P	274
<b>SUZUKI ®</b>	ALTO	1976-1984	TOYO-14	275	TOYO-14	275
	CERVO	1976-1984	TOYO-14P	276	TOYO-14P	276
	CULTUS	1976-1984				
	ESTEEM	1976-1984				
	FRONTE	1976-1984				
	GOLD FINGER	1976-1984				
	JIMMY	1976-1984				
	S.CARRY	1988-				
	SAMURAI	1976-1984				
	SJ 30	1976-1984				
	SJ 310	1976-1984				
	SJ 410	1976-1984				
	SJ 413	1976-1984				
	VITARA	1988-				
	ALTO	1986-1995	SUZU-7	275	SUZU-7	275
	CERVO	1986-	SUZU-7P	275	SUZU-7P	275
	CULTUS	1986-				
	ALTO	1996-	SUZU-8	275	SUZU-8	275
	CARRY VAN	1989-1991	SUZU-8P	275	SUZU-8P	275
	EVERY VAN	1989-1991				
	SWIFT	1989-1991				
	VITARA	1989-1991				
	X-90	1995-1997				
	BALENO	1995-	SUZU-10	275	SUZU-10	275
			SUZU-10P	275	SUZU-10P	275
	CULTUS	1984-1991	MIT-2I	275	MIT-2I	275
	SAMURAI	1984-1989	TOYO-14	275	TOYO-14	275
			TOYO-14P	276	TOYO-14P	276
	ESCUDO	1989-1991	SUZU-10	275	SUZU-10	275
	SIDEKICK	1989-1991	SUZU-10P	275	SUZU-10P	275
	SWIFT	1991-1996				
	FORENZA	2004-2008	DAE-3DP1	274	DAE-3DP1	274
	RENO	2005-2008				
	GRAND VITARA	2008-2013	KRCSUZU-14	366	KRCSUZU-14	366
	SPLASH	2008-2015				
	SWIFT	2005-2010				
	SX4	2006-2012				
	LJ 50	1970-	TOYO-14	275	TOYO-14	275
	LJ 80	1970-	TOYO-14P	276	TOYO-14P	276
			TOYO-K1	275	TOYO-K1	275
			TOYO-K1P	276	TOYO-K1P	276
	RENO	2005-2009	DAE-3DP2	274	DAE-3DP2	274
	SAMURAI	1984-1991	TOYO-14P	276	TOYO-14P	276
	SAMURAI	1989-	IMS-11P	275	IMS-11P	275

FOR: PARA:	MODEL MODELO			PAG.		PAG.
<b>SUZUKI ®</b>			SUZU-9P	275	SUZU-9P	275
	SAMURAI	1992-	TOYO-14P	276	TOYO-14P	276
	SJ 410	1985-1988	IMS-7	274	IMS-10	274
	SJ 413	1985-1988	IMS-7P	274		
	SJ 410	1989-1991	IMS-7	274	IMS-11P	275
	SJ 413	1989-1991	IMS-7P	274	SUZU-9P	275
	VARIOUS MODELS	-	SUZU-14P2	275	SUZU-14P2	275
			SUZU-14P3		SUZU-14P3	
			SUZU-1D	275	SUZU-1D	275
			SUZU-1I	275	SUZU-1I	275
			SUZU-21P	275	SUZU-21P	275
			SUZU-2D	275	SUZU-2D	275
			SUZU-2I	275	SUZU-2I	275
			SUZU-6	275	SUZU-6	275
			SUZU-7DP	275	SUZU-7DP	275
			SUZU-8I	275	SUZU-8I	275
			SUZU-8IP	275	SUZU-8IP	275
			YAMA-20DP	276	YAMA-20DP	276
	VERONA	2004-2007	DAE-4P1	274	DAE-4P1	274
	VITARA	1991-	SUZU-8	275	SUZU-8	275
			SUZU-8P	275	SUZU-8P	275
			SUZU-9P	275	SUZU-9P	275
			IMS-11P	275	IMS-11P	275
<b>TALBOT SIMCA ®</b>	160 GT	1979-	CHR-3	276	CHR-3	276
	180	1979-	NE-22P2	276	NE-22P2	276
	1000	1968-1973	NE-3	276	RO-3	276
			PJ-3	277	PJ-3	277
	1005	1968-1973	NE-3P1	276		
			PJ-K	277		
			PJ-KP	277		
	1006	1968-1973	NE-3P2	276		
	1007	1968-1973				
	1100	1968-1973				
	1501	1970-				
	1100	1974-	CHR-3	276	RO-3	276
			NE-22P2	276		
	1301	1970-1973	NE-3	276	RO-3	276
			NE-3P1	276		
			NE-3P2	276		
	1307	1975-	CHR-3	276	CHR-3	276
			LAS-CR	276	LAS-CR	276
	1308	1975-	NE-22P2	276	NE-22P2	276
			LAS-RC	276	LAS-RC	276
	1309	1978-	NE-22P2	276	NE-22P2	276
	MURENA	1980-				
	150	1975-	LMP-3	276	LMP-3	276
			LMP-3P	276	LMP-3P	276
			LAS-CR	276		
	1510	1975-	LMP-3P	276	LMP-3P	276
	ALPINE	1975-				
	HORIZON	1980-1983				
	MINX	1980-1983				
	OMNI	1980-1983				
	RAPIER	1975-				
	BAGHEERA	1973-	NE-3	276		
			NE-3P1	276		

FOR: PARA:	MODEL MODELO			PAG.		PAG.
<b>TALBOT SIMCA ®</b>			NE-3P2	276		
			PJ-1	277	PJ-1	277
	HORIZON	1977-1979	CHR-3	276	CHR-3	276
			LAS-CR	276	LAS-CR	276
			LAS-RC	276	LAS-RC	276
	HORIZON GL	1977-1979	NE-22P2	276	LMP-3	276
			LAS-RC	276	LAS-RC	276
	MINX	1977-1979			LMP-3P	276
			VA-16	277	VA-16	277
	OMNI	1977-1979			NE-22P2	276
			VA-7	277	VA-7	277
	HORIZON	1984-	CHR-3	276	CHR-3	276
			LAS-BT	276	LAS-BT	276
			PJ-2	277	PJ-2	277
	MINX	1984-	NE-22P2	276	NE-22P2	276
			LAS-TB	276	LAS-TB	276
			PJ-2P	277	PJ-2P	277
	OMNI	1984-	PJ-K	277		
			PJ-KP	277		
	RANCH	1977-	CHR-3	276		
			NE-22P2	276		
			PJ-2	277	PJ-2	277
			PJ-2P	277	PJ-2P	277
	RAPIER	1980-	CHR-3	276	CHR-3	276
	SOLARA	1980-	NE-22P2	276	NE-22P2	276
			LAS-RC	276	LAS-RC	276
			LAS-CR	276	LAS-CR	276
	TAGORA	1980-	NE-33P1	276	NE-33P1	276
	SAMBA	1981-1983	CHR-3	276	CHR-3	276
			NE-22P2	276	NE-22P2	276
			NE-33P1	276	NE-33P1	276
			VA-6	277	VA-6	277
			VA-6P	277	VA-6P	277
	SAMBA	1984-	CHR-3	276	CHR-3	276
			NE-22P2	276	NE-22P2	276
			NE-33P1	276	VA-6	277
					VA-6P	277
			PJ-2	277	PJ-2	277
			PJ-2P	277	PJ-2P	277
			PJ-K	277	PJ-K	277
			PJ-KP	277	PJ-KP	277
	VARIOUS MODELS	-	NE-33P	276	NE-33P	276
			NE-3D	276	NE-3D	276
			RO-1D	277	RO-1D	277
			RO-1DS	276	RO-1DS	276
			RO-1I	277	RO-1I	277
			RO-1IS	276	RO-1IS	276
			RO-2D		RO-2D	
			RO-2I		RO-2I	
			RO-6D	277	RO-6D	277
			RO-6I	277	RO-6I	277
<b>TATA ®</b>	INDICA	2000-	TAT-1D	277	TAT-1D	277
			TAT-1DP	277	TAT-1DP	277
	VARIOUS MODELS	-	TAT-2DP	277	TAT-2DP	277

FOR: PARA:	MODEL MODELO			PAG.		PAG.
<b>TOYOTA ®</b>	3 DR LIFT B.	1988-1989	TOYO-12	279	TOYO-12	279
	4 RUNNER	1988-1989	TOYO-12P1	279	TOYO-12P1	279
	CELICA	1988-1989	TOYO-8	278	TOYO-8	278
	COROLLA	1988-1989	TOYO-8P	278	TOYO-8P	278
	MR2	1989-1990				
	SUPRA EFI SR	1988-1989				
	TERCEL	1989-				
	4 RUNNER	1970-1986	TOYO-12	279	TOYO-12	279
	L.CRUISER	1970-1986	TOYO-12P1	279	TOYO-12P1	279
			TOYO-2	278	TOYO-2	278
			TOYO-K1	278	TOYO-K1	278
			TOYO-K1P	278	TOYO-K1P	278
	4 RUNNER	1986-1988	TOYO-16	280	TOYO-16	280
	CAMRY	1990-1991	TOYO-16P	280	TOYO-16P	280
	DYNA	1990-	TOYO-16P1	280	TOYO-16P1	280
	L.CRUISER	1986-1989	TOYO-5	278	TOYO-5	278
	LITEACE	1990-	TOYO-5P	278	TOYO-5P	278
	RUNNER	1986-1989	TOYO-5P1	278	TOYO-5P1	278
	STARLET	1990-1997				
	VX TURBO	1986-1989		</		

Automóvil. Camioneta  
Automobila. Kamioneta  
Voiture. Camionnette

Auto. Kleintransporter  
Automóvil. Camioneta  
Automóvil. Camioneta

FOR: PARA:	MODEL MODELO			PAG.		PAG.
TOYOTA ®	CAMRY	1984-1989	TOYO-13	279	TOYO-13	279
			TOYO-13P1	279	TOYO-13P1	279
			TOYO-28P	281	TOYO-28P	281
	CAMRY GL	1984-	TOYO-3	278	TOYO-3	278
	CAMRY GLI	1984-	TOYO-3P	278	TOYO-3P	278
	COROLLA 4DR	1986-1996	TOYO-8	278	TOYO-8	278
			TOYO-8P	278	TOYO-8P	278
	CARINA	1972-1982	TOYO-14	278	TOYO-14	278
	CELICA	1972-1982	TOYO-14P	278	TOYO-14P	278
	COROLLA	1972-1974	TOYO-K1	278	TOYO-K1	278
	CORONA	1972-1974	TOYO-K1P	278	TOYO-K1P	278
	CROWN	1972-1982				
	HIACE	1975-1982				
	HILUX	1973-1978				
	MARK II	1972-1982				
	PUBLICA	1972-1974				
	STARLET	1972-1982				
	CARINA	1983-1985	TOYO-3	278	TOYO-3	278
	COROLLA	1975-1982	TOYO-3P	278	TOYO-3P	278
	CORONA	1983-1985	TOYO-8	278	TOYO-8	278
	CORSA	1983-1985	TOYO-8P	278	TOYO-8P	278
	CRESSIDA	1983-1985				
	CRESTA	1983-1985				
	CROWN	1983-1985				
	MARK II	1983-1985				
	MR2	1983-1985				
	SPRINTER	1983-1985				
	TERCEL	1983-1985				
	CARINA	1985-1986	TOYO-3	278	TOYO-3	278
	CORONA	1985-1986	TOYO-3P	278	TOYO-3P	278
	SPRINTER	1985-1986				
	TERCEL 4WD	1985-1986				
	CARINA	1994-	TOYO-19P	280	TOYO-19P	280
	CELICA	1983-1985	TOYO-12	279	TOYO-12	279
			TOYO-12D	279	TOYO-12D	279
			TOYO-12P1	279	TOYO-12P1	279
			TOYO-22	280	TOYO-22	280
			TOYO-22D	280	TOYO-22D	280
			TOYO-3	278	TOYO-3	278
			TOYO-3P	278	TOYO-3P	278
			TOYO-8	278	TOYO-8	278
			TOYO-8P	278	TOYO-8P	278
			TOYO-K1	278	TOYO-K1	278
			TOYO-K1P	278	TOYO-K1P	278
	CELICA	1986-1988	TOYO-10	279	TOYO-10	279
	COROLLA ST	1988-1989	TOYO-10P	279	TOYO-10P	279
	TERCEL	1987-1988	TOYO-11	279	TOYO-11	279
			TOYO-11P	279	TOYO-11P	279
	CELICA	1990-1995	TOYO-10	279	TOYO-10	279
			TOYO-20D	280	TOYO-20D	280
			TOYO-10P	279	TOYO-10P	279
			TOYO-10P1	279	TOYO-10P1	279
			TOYO-11	279	TOYO-11	279
			TOYO-11P	279	TOYO-11P	279
			TOYO-11P1	279	TOYO-11P1	279
			TOYO-20D	280	TOYO-20D	280
			TOYO-9	279	TOYO-9	279

FOR: PARA:	MODEL MODELO			PAG.		PAG.
TOYOTA ®			TOYO-9P	279	TOYO-9P	279
			TOYO-9P1	279	TOYO-9P1	279
	CELICA 4WD	1990-1991	TOYO-10	279	TOYO-10	279
	MR2	1990-1991	TOYO-10P	279	TOYO-10P	279
	PREVIA	1993-1997	TOYO-10P1	279	TOYO-10P1	279
			TOYO-11	279	TOYO-11	279
			TOYO-11P	279	TOYO-11P	279
			TOYO-11P1	279	TOYO-11P1	279
	CELICA COUPE	1991-1994	TOYO-37D	281	TOYO-37D	281
	CELICA LIFT.	1991-1996	TOYO-10	279	TOYO-10	279
			TOYO-10P1	279	TOYO-10P1	279
	CELICA SUPRA	1982-1985	TOYO-4	278	TOYO-4	278
			TOYO-4P	278	TOYO-4P	278
	COROLLA	-19-	TOYO-8IP	278	TOYO-8IP	278
	COROLLA	1983-1987	TOYO-12	279	TOYO-12	279
	TERCEL	1985-1987	TOYO-12P1	279	TOYO-12P1	279
			TOYO-22	280	TOYO-22	280
			TOYO-22D	280	TOYO-22D	280
			TOYO-K1	278	TOYO-K1	278
			TOYO-K1P	278	TOYO-K1P	278
	COROLLA 5	1972-1976	TOYO-2	278	TOYO-2	278
			TOYO-4	278	TOYO-4	278
			TOYO-4P	278	TOYO-4P	278
	COROLLA DX	1985-1996	TOYO-23	280	TOYO-23	280
			TOYO-23P	280	TOYO-23P	280
	COROLLA GT	1985-1996	TOYO-8	278	TOYO-8	278
			TOYO-8P	278	TOYO-8P	278
	COROLLA SM	1973-1978	TOYO-14	278	TOYO-14	278
			TOYO-14P	278	TOYO-14P	278
			TOYO-4	278	TOYO-4	278
			TOYO-4P	278	TOYO-4P	278
			TOYO-K1	278	TOYO-K1	278
			TOYO-K1P	278	TOYO-K1P	278
	COROLLA SW	1993-1996	TOYO-17	280	TOYO-17	280
			TOYO-17P	280	TOYO-17P	280
	CRESSIDA	1977-1978	TOYO-23	280	TOYO-23	280
	CRESTA	1977-1978	TOYO-23P	280	TOYO-23P	280
	CRESSIDA	1984-1987	TOYO-28P	281	TOYO-28P	281
	CRESSIDA	1985-1987	TOYO-13	279	TOYO-13	279
			TOYO-13P1	279	TOYO-13P1	279
	FX 16	1987-1988	TOYO-K1	278	TOYO-K1	278
			TOYO-K1P	278	TOYO-K1P	278
	HDJ 80	1991-	TOYO-18P	280	TOYO-18P	280
	L.CRUISER	1991-				
	HILUX 4x4	1995-	TOYO-20D	280	TOYO-20D	280
	MR2	1991-1997	TOYO-9	279	TOYO-9	279
			TOYO-9P	279	TOYO-9P	279
			TOYO-9P1	279	TOYO-9P1	279
	PASEO	1991-1997	TOYO-10	279	TOYO-10	279
			TOYO-10P	279	TOYO-10P	279
			TOYO-10P1	279	TOYO-10P1	279
	PROACE	2013-2016	KRCHU-HCA	367	KRCHU-HCA	367
	STARLET	1984-1990	TOYO-K1	278	TOYO-K1	278
			TOYO-K1P	278	TOYO-K1P	278
	VARIOS	-1969	TOYO-25	280	TOYO-25	280
	VARIOS	1970-	TOYO-29	281	TOYO-29	281
	VARIOS BRANDS	-	TOYO-9P2	279	TOYO-9P2	279

FOR: PARA:	MODEL MODELO			PAG.		PAG.
TOYOTA ®	VARIOUS MODELS		MIT-2DP	278	MIT-2DP	278
			TOYO-12DP1	279	TOYO-12DP1	279
			TOYO-15DP	279	TOYO-15DP	279
			TOYO-15P10	279	TOYO-15P10	279
			TOYO-24	280	TOYO-24	280
			TOYO-26	280	TOYO-26	280
			TOYO-30P1	281	TOYO-30P1	281
			TOYO-40	281	TOYO-40	281
			TOYO-40D	281	TOYO-40D	281
			TOYO-41P	280	TOYO-41P	280
			TOYO-6	278	TOYO-6	278
	VARIOUS MODELS	1983-	MIT-2D	278	MIT-2D	278
TOYOTA (AUSTRALIA) ®	CAMRY	2011-2015	KRCTOYO-15	367	KRCTOYO-15	367
	COROLLA	2010-2013				
	HIACE	2010-2012				
TOYOTA (USA) ®	4RUNNER	1999-2002	KRCTOYO-15	367	KRCTOYO-15	367
	4RUNNER	2010-2016				
	4RUNNER USA	2002-2009				
	AVALON	2002-2004				
	CAMRY	2002-2006				
	CAMRY	2006-2011				
	CAMRY	2015-2016				
	COROLLA	2003-2005				
	COROLLA	2005-2008				
	COROLLA	2009-2010				
	COROLLA	2014-2016				
	FJ CRUISER	2007-2008				
	FJ CRUISER	2008-2009				
	FJ CRUISER	2010-2010				
	FJ CRUISER	2011-2014				
	HIGHLANDER	2001-2003				
	HIGHLANDER	2004-2007				
	LAND CRUISER	2006-2007				
	LELICA	2004-2005				
	MATRIX	2004-2008				
	PRIUS	2001-2003				
	RAV4	2001-2003				
	RAV4	2004-2005				
	RAV4	2006-2010				
	RAV4	2010-2012				
	SEQUOIA	2001-2003				
	SEQUOIA	2004-2007				
	SIENNA	1999-2003				
	SIENNA	2001-2003				
	SIENNA	2002-2003				
	THAILAND	2005-2009				
	TUNDRA	2004-2005				
	TUNDRA	2006-2006				
	YARIS	2006-2010				
	YARIS	2007-2011				
	YARIS	2012-2014				
TRABANT ®	TODOS	-19-	DOB-1	281	DOB-1	281

FOR: PARA:	MODEL MODELO			PAG.		PAG.
TRABANT ®			DOB-1D	281	DOB-1D	281
			DOB-2	281	DOB-2	281
			DOB-2D	281	DOB-2D	281
			DOB-3	281	DOB-3	281
			DOB-3D	281	DOB-3D	281
TRIUMPH ®	ACCLAIM	1981-	HOND-1	281	HOND-1	281
			HOND-1P	281	HOND-1P	281
			HOND-2	281	HOND-2	281
			HOND-2P	281	HOND-2P	281
	DOLOMITE	1973-	UN-NH	282	UN-FS	282
	TOLEDO	1973-	UN-NHP			
	GT6 MK3	-19-	FO-FR	281	UN-NH	282
			FO-FRP	281	UN-NHP	
			UN-NHP	282		
			WAS-2P	282		
	GTX MK3	1972-	FO-FR	281	UN-NH	282
			UN-FT	282	UN-FT	282

Automóvil. Camioneta  
Automobila. Kamioneta  
Voiture. Camionnette

Auto. Kleintransporter  
Automóvil. Camioneta  
Automóvil. Camioneta

FOR: PARA:	MODEL MODELO			PAG.		PAG.
VARIOUS BRANDS				BAS-3 150		BAS-2I 150
				BL-5 150		BAS-3 150
				BL-5D 150		BL-5 150
				BL-6 150		BL-5D 150
				BL-6D 150		BL-6 150
				BUR-6 150		BL-6D 150
				CAM-1D 150		BUR-6 150
				CHR-6 150		CAM-1D 150
				CHR-6D 150		CHR-6 150
				CN-1D 150		CHR-6D 150
				GH-1 151		CN-1D 150
				GH-2 151		GH-1 151
				GH-3 151		GH-2 151
				GH-PS 151		GH-3 151
				HU-NW 151		GH-PS 151
				HU-P 151		HU-NW 151
				KAM-1 151		HU-P 151
				KAM-ID 151		KAM-1 151
				MERI-ID 151		KAM-ID 151
				MERI-IDP 151		MERI-ID 151
				MERI-IP1 152		MERI-IDP 151
				MERI-2DP 151		MERI-IP1 152
				MOD-IDP 152		MERI-2DP 151
				NE-1D 152		MOD-IDP 152
				NE-IDP 152		NE-1D 152
				NE-2 152		NE-IDP 152
				NE-27 152		NE-2 152
				NE-30 152		NE-27 152
				NE-30P 152		NE-30 152
				NE-31 152		NE-30P 152
				NE-31P 152		NE-31 152
				NE-32 152		NE-31P 152
				NE-32P 152		NE-32 152
				NE-44P 152		NE-32P 152
				NE-48 152		NE-44P 152
				NE-49 152		NE-48 152
				NE-54P 153		NE-49 152
				NE-57 153		NE-54P 153
				NE-63D 153		NE-57 153
				OP-1 153		NE-63D 153
				OP-DD 153		OP-1 153
				PRE-2I 153		OP-DD 153
				SIM-1200 153		PRE-2I 153
				SIX-5P 153		SIM-1200 153
				STR-3 153		SIX-5P 153
				TAP-1P 154		STR-3 153
				TAP-2 154		TAP-1P 154
				TIT-7D 154		TAP-2 154
				TOYO-30P1 154		TIT-7D 154
				TOYO-6 154		TOYO-30P1 154
				TRL-1P 154		TOYO-6 154
				UN-NC 154		TRL-1P 154
				VA-3 154		UN-NC 154
				VA-3I 154		VA-3 154
				VO-VA 154		VA-3I 154
				VO-VAP 154		VO-VA 154
				WAS-10DP 154		VO-VAP 154

FOR: PARA:	MODEL MODELO			PAG.		PAG.
VARIOUS BRANDS				WAS-10P 154		WAS-10DP 154
				WAS-3 154		WAS-10P 154
				YA-27 154		WAS-3 154
				YA-27D 154		YA-27 154
				ZA-5P 155		YA-27D 154
						ZA-5P 155
	VARIOUS MODELS	-2020		BL-3 150		BL-3 150
				BL-4 150		BL-4 150
				BL-4D 150		BL-4D 150
				LAS-5 151		LAS-5 151
				LAS-5D 151		LAS-5D 151
				NE-60C1 358		NE-60C1 358
VAUXHALL®	ASTRA	1975-1979	OP-J	283	OP-J	283
	CHEVRETTE	1975-1979	OP-JP	283	OP-JP	283
	ASTRA	1984-1995	OP-D	283	OP-D	283
	ASTRAMAX	1984-	OP-DP	283	OP-DP	283
	BELMONT	1984-	OP-S	283	OP-S	283
	NOVA	1984-	OP-SP	283	OP-SP	283
	CARLTON	1978-1981	OP-R	283	OP-R	283
	VICEROY	1978-1989	OP-RP	283	OP-RP	283
			OP-T	283	OP-T	283
			OP-TP	283	OP-TP	283
	CARLTON	1982-	OP-WHP	283	OP-WHP	283
	CAVALIER	1982-	OP-WYP	283	OP-WYP	283
	SENATOR	1982-				
	CAVALIER	1975-1981	OP-AB	282	OP-AB	282
			OP-ABP	282	OP-ABP	283
			OP-BA	282	OP-BA	282
			OP-BAP	283	OP-BAP	283
			OP-J	283	OP-J	283
			OP-JP	283	OP-JP	283
	FIRENZA	-19-	LF-RO	282	LF-6	282
			LF-ROP	282		
	ROYALE	1984-	OP-D	283	OP-D	283
			OP-DP	283	OP-DP	283
			OP-S	283	OP-S	283
			OP-SP	283	OP-SP	283
	GAZ 024	-19-	VOL-1		VOL-1	
VOLGA®			VOL-1P	283	VOL-1P	283
	GAZ 029	-19-	NE-3	283	VOL-1	283
			NE-3P	283	VOL-1P	283
			NE-3P2	283	VOL-2	284
					VOL-2D	284
					VOL-3	284
	GAZ 3110	-19-	NE-3	283	VOL-1	283
			NE-3P	283	VOL-1P	283
			NE-3P2	283	VOL-4	284
					VOL-5P	284
	VARIOUS MODELS	-	NE-3D	283	NE-3D	283
1500	-19-				CHR-8	
VOLKSWAGEN®	1303 CABRIO	1970-	HU-SU	285	VO-M	286

FOR: PARA:	MODEL MODELO			PAG.		PAG.
VOLKSWAGEN®				VO-MP		286
	1500	-19-	CHR-11	284	CHR-11	284
			CHR-11P	284	CHR-11P	284
	1500	1970-1972	VO-K	286		
	1600	1970-1972				
	411	1970-1972				
	412	1970-1972				
	BRASILIA	1970-1972				
	411	1973-1974	VO-VB	286	VO-VB	286
	412	1973-1974	VO-VBP	286	VO-VBP	286
	BRASILIA	1973-1974				
	IGALA	1973-1974				
	ALL STAR	1991-	VO-2	286	VO-2	286
	CALIFORNIA	1991-	VO-2P	286	VO-2P	286
	CLUB VAN	1991-				
	SINCRO	1991-				
	TRANSPORTER	1991-1995				
	AMAROK	2011-2015	KRCHU-HAA	367	KRCHU-HAA	367
	BEETLE	1999-2003				
	BEETLE	2002-2005				
	BEETLE	2005-2010				
	BEETLE	2012-2013				
	BORA	1998-2000				
	BORA	1999-2001				
	BORA	2002-2005				
	BORA	2011-2013				
	CADDY	2004-2011				
	CADDY	2010-				
	CADDY	2011-2013				
	EOS	2006-2011				
	EOS	2009-2013				
	GOL	2010-2013				
	GOLF	1998-2001				
	GOLF	2002-2004				
	GOLF	2004-2009				
	GOLF	2009-2011				
	GOLF	2011-2013				
	GOLF PLUS	2005-2009				
	GOLF PLUS	2009-2011				
	GOLF PLUS	2011-2013				
	LAVIDA	2011-2016				
	MPV TRANSPORTER	2004-2010				
	MPV TRANSPORTER	2010-2014				
	MPV TRANSPORTER	2012-				
	NOUVELLE COCCINELLE	2012-2013				
	PASSAT	1997-2000				
	PASSAT	2001-2005				
	PASSAT	2011-2016				
	POLO	2002-2009				
	POLO	2009-2010				
	POLO	2010-2013				
	SAGITAR	2011-2017				
	SCIROCCO	2009-2010				
	SCIROCCO	2011-2013				
	SHARAN	2011-				

FOR: PARA:	MODEL MODELO			PAG.		PAG.
VOLKSWAGEN®	SHARAN	2011-2013				
	TIGUAN	2008-2011				
	TIGUAN	2010-2013				
	TIGUAN	2011-2016				
	TIGUAN	2012-				
	TOURAN	2003-2010				
	TOURAN	2010-2014				
	UP	2012-				
	BEETLE	1970-1978	VO-M	286	VO-M	286
			HU-SU	285	HU-SU	285
	EL VOLKSWAGE	1970-1978	VO-MP	286	VO-MP	286
	ESCARABAJA	1970-1978				
	FUSCA	1970-1978				
	CABRIOLET	1975-1981	VO-VB	286	VO-VB	286
			VO-VBP	286	VO-VBP	286
			BL-2	284	BL-2	284
			FO-PN	285	FO-PN	285
			HU-SU	285	HU-SU	285
	CADDY	-19-	AU-1	284	AU-1	284
			AU-HV	284	AU-HV	284
			AU-HVP	284	AU-HVP	284
			VO-HV	286	VO-HV	286
			VO-HVP	286	VO-HVP	286
	CORRADO	1988-	AU-AN	284	AU-AN	284
			VO-2	286	VO-2	286
	GOLF	1988-1990	AU-ANP	284	AU-ANP	284
			VO-2P	286	VO-2P	286
	JETTA ATLAN.	1988-	HU-AN	285	HU-AN	285
	PASSAT	1988-1995	VO-2	286	VO-2	286
	VENTO	1992-1995	VO-2P	286	VO-2P	286
	CRAFTER	2006-2013	KRCME-7	367	KRCME-7	367
	DERBY AMAZON	1977-1980	VO-VB	286	VO-VB	286
			BL-1I	284	BL-1I	284
	FAMILCAR	1977-1980	VO-VBP	286	VO-VBP	286
			PJ-1	285	PJ-1	285
	GOLF	1977-1980	PJ-2	285	PJ-2	285
	PASSAT	1977-1980	PJ-2P	285	PJ-2P	285
	POLO	1977-1980				
	DERBY AMAZON	1981-1982	AU-1	284	AU-1	284
	GOLF	1981-1982	AU-HV	284	AU-HV	284
	GOLF CABRIO	1981-1984	AU-HVP	284	AU-HVP	284
	JETTA ATLAN.	1981-1984	VO-HV	286	VO-HV	286
			BL-2	284	BL-2	284
	PASSAT	1981-1984	VO-HVP	286	VO-HVP	286
	SANTANA	1981-1982	VO-VB	286	VO-VB	286
	SCIROCCO	1981-1982	VO-VBP	286	VO-VBP	286
	DERBY AMAZON	1985-1987	AU-1	284	AU-1	284
	GOLF	1985-1987	AU-HV	284	AU-HV	284
	JETTA ATLAN.	1985-1987	AU-HVP	284	AU-HVP	284
	PASSAT	1985-1987	VO-HV	286	VO-HV	286
			BL-1I	284	BL-1I	284
	POLO	1985-1991	VO-HVP	286	VO-HVP	286
	SCIROCCO	1985-1987	VO-VB	286	VO-VB	286
			FO-PN	285	FO-PN	285
			VO-VBP	286	VO-VBP	286
			VO-HV	286	VO-HV	286
	GACEL	-19-	VO-FHP	286	VO-FHP	286

Automóvil. Camioneta  
Automobila. Kamioneta  
Voiture. Camionnette

Auto. Kleintransporter  
Automóvil. Camioneta  
Automóvil. Camioneta

FOR: PARA:	MODEL MODELO			PAG.		PAG.
<b>VOLKSWAGEN</b> ®	SENDA	-19-				
	GOL	-19-	VO-FHP	286	VO-FHP	286
	GOLF	1975-1977	VO-VB	286	HU-SU	285
			VO-VBP	286	VO-VB	286
					VO-VBP	286
	GOLF	1987-1988	VO-2	286	VO-2	286
			VO-2P	286	VO-2P	286
			VO-AHP	286	VO-AHP	286
	GOLF	1991-1995	AU-AN	284	AU-AN	284
			AU-ANP	284	AU-ANP	284
			HU-AN	285	HU-AN	285
			VO-2	286	VO-2	286
			VO-2P	286	VO-2P	286
	GOLF	2013-	HU-HAAC4	358	HU-HAAC4	358
	K 70	1970-1973	FO-PN	285	FO-PN	285
	K 70 LS	1970-1973	VO-VB	286	VO-VB	286
			VO-VBP	286	VO-VBP	286
	LT 28D	1970-1979	VO-R	286	VO-R	286
			HU-SU	285	HU-SU	285
	LT 31	1970-1979	VO-RP	286	VO-RP	286
	TL 31	1970-1979				
	TL 45	1970-1979				
	TL 50	1970-1979				
	MODELOS	1966-1969	FO-D	284	VO-L	286
			VO-L	286		
			HU-SU	285	HU-SU	285
	PASSAT	1973-	VO-VB	286	VO-VB	286
			VO-VBP	286	VO-VBP	286
	PASSAT FAM.	1973-1976	VO-R	286	VO-R	286
			VO-RP	286	VO-RP	286
	POLARA	-19-	CHR-11	284	CHR-11	284
	POLO	1975-1976	VO-VB	286	VO-VB	286
			VO-VBP	286	VO-VBP	286
	POLO	1981-1982	AU-1	284	AU-1	284
			AU-HV	284	AU-HV	284
			AU-HVP	284	AU-HVP	284
			VO-HV	286	VO-HV	286
			VO-HVP	286	VO-HVP	286
			BL-11	284	BL-11	284
	POLO	1991-1995	VO-2	286	VO-2	286
			VO-2P	286	VO-2P	286
			BL-2	284	BL-2	284
	SCIROCCO	1975-1981	VO-VB	286	VO-VB	286
			VO-VBP	286	VO-VBP	286
			BL-11	284	BL-11	284
			PJ-2	285	PJ-2	285
			PJ-2P	285	PJ-2P	285
	TARO NISSAN	1989-	TOYO-20D	285	TOYO-20D	285
			TOYO-9	285	TOYO-9	285
			TOYO-9P	285	TOYO-9P	285
			TOYO-9P1	285	TOYO-9P1	285
	TL 31	1980-	VO-N	286	VO-N	286
	TL 35	1980-	VO-NP	286	VO-NP	286
	TL 45	1980-				
	TL 50	1980-				
	TRANSPORTER	1980-1991				

FOR: PARA:	MODEL MODELO			PAG.		PAG.
<b>VOLKSWAGEN</b> ®	VAGON	1980-				
	VARIOUS MODELS	-	HU-HAAC5	358	HU-HAAC5	358
			HU-HAAP1	285	HU-HAAP1	285
			HU-NAAC2	358	HU-NAAC2	358
			SE-AN	285	SE-AN	285
			VO-KP	286	VO-KP	286
			VW-K70	286	VW-K70	286
	VARIOUS MODELS	-2020	HU-HAAC1	358	HU-HAAC1	358
			HU-HAAC2	358	HU-HAAC2	358
			HU-HAAC3	358	HU-HAAC3	358
<b>VOLKSWAGEN (ARGEN.)</b> ®					CHR-8P	286
	1500	1980-	CHR-12	287	WAS-1	288
	1800	1980-				
	1800 RURAL	1980-	CHR-11P	287	CHR-11P	287
	GACEL	-19-	VO-FHP1	287	VO-FHP1	287
			GAS-1	287	GAS-1	287
	GOL	-1995	VO-FHP1	287	VO-FHP1	287
			LI-ID		LI-ID	
			VO-VB	287	VO-VB	287
			VO-VBP	287	VO-VBP	287
	GOL	1996-	VO-2DP	287	VO-2DP	287
			VO-2DP1	287	VO-2DP1	287
			VO-6D	287	VO-6D	287
	GOL	1997-	VO-8P	287	VO-8P	287
			VO-8P1	287	VO-8P1	287
	KOMBI	-19-	VO-R	287	VO-R	287
			VO-RP	287	VO-RP	287
			GAS-1	287	GAS-1	287
	POINTER	-19-	VO-5P	287	VO-5P	287
	SAVEIRO	-19-	VO-HV	287	VO-HV	287
			VO-HVP	287	VO-HVP	287
			VO-VB	287	VO-VB	287
			VO-VBP	287	VO-VBP	287
			CLI-1D	287	CLI-1D	287
			VO-6D	287	VO-6D	287
	SENDA	-19-	VO-HV	287	VO-HV	287
			VO-HVP	287	VO-HVP	287
			CLI-1D	287	CLI-1D	287
			GAS-1	287	GAS-1	287
	VARIOUS MODELS	-	VO-HVP1	287	VO-HVP1	287
	PASSAT	2010-2013	KRCHU-HAA		KRCHU-HAA	
<b>VOLKSWAGEN (AUS)</b> ®	VENTO	2010-				
	FOX	1975-1976	VO-VB		VO-VB	
			AU-W		AU-W	
<b>VOLKSWAGEN (BRASIL)</b> ®	GOL	1975-1976	VO-VBP	289	VO-VBP	289
	FOX	1977-1980	VO-VB	289	VO-VB	289
			BL-11	288	BL-11	288
	GOL	1977-1980	VO-VBP	289	VO-VBP	289
			PJ-1	288	PJ-1	288
			PJ-2	288	PJ-2	288
			PJ-2P	289	PJ-2P	289

FOR: PARA:	MODEL MODELO			PAG.		PAG.
<b>VOLKSWAGEN (BRASIL)</b> ®	PARATI	1977-1980	PJ-2	288	PJ-2	288
	QUANTUM	1977-1980	PJ-2P	289	PJ-2P	289
	FOX	1981-1982	AU-1	288	AU-1	288
	GOL	1981-1982	AU-HV	288	AU-HV	288
			AU-HVP	288	AU-HVP	288
			VO-HV	289	VO-HV	289
			VO-HVP	289	VO-HVP	289
	FOX	1985-1991	AU-1	288	AU-1	288
	GOL	1985-1991	AU-HV	288	AU-HV	288
	PARATI	1985-1987	AU-HVP	288	AU-HVP	288
	QUANTUM	1985-1987	VO-HV	289	VO-HV	289
			VO-HVP	289	VO-HVP	289
			VO-VB	289	VO-VB	289
			VO-VBP	289	VO-VBP	289
			BL-11	288	BL-11	288
			BL-2	288	BL-2	288
			FO-PN	288	FO-PN	288
	FOX	1991-	VO-2	289	VO-2	289
			BL-2	288	BL-2	288
	GOL	1991-	VO-2P	289	VO-2P	289
	GOL	1991-1997	VO-2P	289	VO-2P	289
			BL-2	288	BL-2	288
	GOL	1998-	VO-2DP1	289	VO-2DP1	289
	VARIOS	1996-	VO-2P1	289	VO-2P1	289
			VO-8P1	289	VO-8P1	289
	PARATI	1973-	VO-VB	289	VO-VB	289
			FO-PN	288	FO-PN	288
	QUANTUM	1973-	VO-VBP	289	VO-VBP	289
	PARATI	1981-1984	AU-1	288	AU-1	288
	QUANTUM	1981-1984	AU-HV	288	AU-HV	288
	SANTANA	1981-1982	AU-HVP	288	AU-HVP	288
			VO-HV	289	VO-HV	289
			VO-HVP	289	VO-HVP	289
			VO-VB	289	VO-VB	289
			VO-VBP	289	VO-VBP	289
			BL-2	288	BL-2	288
	PARATI	1988-	AU-AN	288	AU-AN	288
	QUANTUM	1988-	AU-ANP	288	AU-ANP	288
			HU-AN	288	HU-AN	288
			VO-2	289	VO-2	289
			VO-2P	289	VO-2P	289
<b>VOLKSWAGEN (CHINA)</b> ®	SHANGHAI	1973-	VO-VB	290	VO-VB	290
			VO-VBP	290	VO-VBP	290
	SHANGHAI	1977-1980	VO-VB	290	VO-VB	290
			VO-VBP	290	VO-VBP	290
			PJ-1	290	PJ-1	290
			PJ-2	290	PJ-2	290
			PJ-2P	290	PJ-2P	290
	SHANGHAI	1981-1984	AU-1	289	AU-1	289
			AU-HV	289	AU-HV	289
			AU-HVP	289	AU-HVP	289
			VO-HV	290	VO-HV	290
			VO-HVP	290	VO-HVP	290
			VO-VB	290	VO-VB	290
			VO-VBP	290	VO-VBP	290

FOR: PARA:	MODEL MODELO			PAG.		PAG.
<b>VOLKSWAGEN (CHINA)</b> ®					BL-2	290
					BL-2	290
	SHANGHAI	1985-1987	AU-1	289	AU-1	289
			AU-HV	289	AU-HV	289
			AU-HVP	289	AU-HVP	289
			VO-HV	290	VO-HV	290
			VO-HVP	290	VO-HVP	290
			VO-VB	290	VO-VB	290
			VO-VBP	290	VO-VBP	290
	SHANGHAI	1988-	AU-AN	289	AU-AN	289
			AU-ANP	289	AU-ANP	289
			HU-AN	290	HU-AN	290
			VO-2	290	VO-2	290
			VO-2P	290	VO-2P	290
<b>VOLKSWAGEN (MEXICO)</b> ®	ESCARABAJO	-19-	VO-M	291	VO-M	291
			VO-MP	291	VO-MP	291
			HU-SU	291	HU-SU	291
<b>VOLKSWAGEN (USA)</b> ®	BEETLE	1998-1999	KRCHU-HAA	367	KRCHU-HAA	367
	BEETLE	2000-2001				
	BEETLE	2002-2010				
	EOS	2007-2013				
	GOLF	2010-2013				
	JETTA	1999-2010				
	JETTA	2010-2013				
	JETTA	2013-2016				



Automóvil. Camioneta  
Automobila. Kamioneta  
Voiture. Camionnette

Auto. Kleintransporter  
Automóvil. Camioneta  
Automóvil. Camioneta

FOR: PARA:	MODEL MODELO			PAG.		PAG.
<b>VOLVO</b> ®	262			1977-1978		
	264			1977-1978		
	265			1977-1978		
	240			1978-1984	NE-12	292
	242			1978-1983	NE-12P	292
	244			1978-1983		
	245			1978-1983		
	262			1978-1983		
	264			1978-1983		
	265			1978-1983		
	240			1984-1985	NE-12	292
					NE-12P	292
					NE-18	292
					NE-18P	292
	340			1976-1984	HU-DF	291
	343			1976-1984	HU-DFP1	291
	345			1976-1984	HU-DFP1	
	360			1976-1984		
	340			1985-1986	HU-DF	291
	360			1985-1986	HU-DFP1	291
					HU-DFP1	
	440			1987-	HU-DHP	291
	460			1987-	HU-DNP	291
	480			1987-		
	740			1986-1991	NE-12	292
	760			1984-1987	NE-12P	292
	780			1986-1991	NE-18	292
	940			1991-1996	NE-18P	292
	760			1991-	NE-40	292
	762			1991-	NE-40P	292
	764			1991-	NE-41P	292
	765			1991-		
	960			1991-1996		
	850			1991-1996	NE-40	292
					NE-40P	292
	AMAZON 140			-1973	NE-13	292
					NE-56	292
					UN-FP	292
					UN-FS	292
	FH 12			1997-	HU-DHP	291
	PV AMAZON			-19-	AS-11	291
					AS-24	291
<b>WARTBURG</b> ®	MODELLOS			-19-	DOB-1	292
					DOB-1D	292
					DOB-2	292
					DOB-2D	292
					DOB-3	293
					DOB-3D	293
<b>YAMAHA</b> ®	VARIOUS MODELS			-	YAMA-10D	293
					YAMA-10I	293
					YAMA-11D	293
					YAMA-11I	293
					YAMA-12D	293
					YAMA-12I	293
					YAMA-1D	293
					YAMA-1I	293
					YAMA-20DP	293

FOR: PARA:	MODEL MODELO			PAG.		PAG.		
<b>YAMAHA</b> ®				YAMA-2D	293	YAMA-2D	293	
				YAMA-2I	293	YAMA-2I	293	
				YAMA-4D	293	YAMA-4D	293	
				YAMA-6D	293	YAMA-6D	293	
				YAMA-6I	293	YAMA-6I	293	
				YAMA-7D	293	YAMA-7D	293	
				YAMA-7I	293	YAMA-7I	293	
				YAMA-8D	293	YAMA-8D	293	
				YAMA-8I	293	YAMA-8I	293	
<b>YUGO-ZASTAVA</b> ®	101			1971-1982	FO-FR	294		
	311			1971-1982	FO-FRP	294		
	411			1971-1982		IMS-5	294	
	413			1971-1982		IMS-5P	294	
	511			1971-1982				
	513			1971-1982				
	KORAL			1987-	FI-6I	294	FI-3D	293
	YUGO 45			1987-	FI-6IP3	294	FI-3DP	293
	YUGO 55			1987-		FI-3DP5	294	
	YUGO 65			1987-				
	YUGO 45			-19-	CL-7P	293	CL-7P	293
					FI-6IP	294	FI-6IP	294
	YUGO 45			1982-1984	FI-6I	294	FI-6I	294
	YUGO 55			1982-1984	FI-6IP3	294	FI-6IP3	294
					FO-E-TC	294	IMS-3	294
					FO-E-TCP	294	IMS-3P	294
					FO-FR	294	IMS-5	294
					FO-FRP	294	IMS-5P	294
						SIP-1	294	
	YUGO 45			1985-1986	FI-6I	294	YU-1D	294
	YUGO 55			1985-1986	FI-6IP3	294		
	YUGO 65			1985-1986				
	YUGO 45			1986-1987	FI-6I	294	IMS-3	294
	YUGO 55			1986-1987	FI-6IP3	294	IMS-3P	294
	YUGO 65			1986-1987		IMS-5	294	
						IMS-5P	294	
<b>ZAZ</b> ®	966			-19-	NE-3	294	VOL-3	295
	968 A			-19-	NE-3P	295		
	968 M			-19-	NE-3P1	295		
					NE-3P2	295		
	TAVRIA			-19-	NE-3	294	AF-19	294
					NE-3P	295	AF-19P	294
					NE-3P1	295		
					NE-3P2	295		
	VARIOUS MODELS			-	NE-3D	294	NE-3D	294

Camión  
Kamioi  
Camions

Lkw  
Camión  
Ciężarowych

FOR: PARA:	MODEL MODELO			PAG.		PAG.		
<b>ASTRA</b> ®	BM 64.26			-19-	AF-7I	296	IMS-3	296
	BM 64.30			-19-	AF-7IP	296	IMS-3P	296
	BM 64.36			-19-	AF-8D	296	IMS-5	296
	BM 66.30			-19-	AF-8DP	296	IMS-5P	296
	BM 66.36			-19-	AF-8I	296		
	BM 201			-19-	AF-8IP	296		
	BM 305			-19-	AF-9D	296		
					AF-9DP	296		
					AF-9I	296		
					AF-9IP	296		
<b>BEDFORD</b> ®	CF			-1980	LF-9	296	UN-1FS	296
					LF-RO	296		
					LF-ROP	296		
					NE-10	296		
					NE-10P	296		
	CF			1980-	NE-10	296	UN-FT	296
	CF 2 250 D			1980-	NE-10P	296	WAS-6	297
	CF 2 350 D			1980-		WAS-6P		
	TL 560			-19-	NE-1	296	LF-6	296
	TL 860			-19-	NE-10	296		
	TL 1260			-19-	NE-10P	296		
	TM			-19-	NE-1P	296		
<b>BROCKWAY</b> ®	VARIOUS MODELS			-	BS-4D	297	BS-4D	297
					YA-8D	297	YA-8D	297
					YA-8I	297	YA-8I	297
					HUD-1	297	HUD-1	297
					YA-11D	297	YA-11D	297
					YA-11I	297	YA-11I	297
<b>DAF</b> ®	2800			-19-	CHR-3	297	FO-OA	297
	3600			-19-	CHR-3P	297		
	FA 2100 DT			-19-				
	FA 2105			-19-				
	FA 2505			-19-				
	FA 2805			-19-				
	FA 3605			-19-				
	FAS 3605			-19-				
	FAT 2826			-19-				
	FAT 3626			-19-				
	FT 2505			-19-				
	FT 2805			-19-				
	FT 3605			-19-				
	FTT 2826			-19-				
	FTT 3626			-19-				
	2800 T. IN.			-1984	NE-3	297	FO-OA	297
	FA 1100			1980-1982	NE-3P	297		
	FA 1300 T			1980-1982	NE-3P1	298		
	FA 2100			1980-1982	NE-3P2	298		
	FA 2500			1980-1982				
	F 1100			1985-1991	CHR-3	297	FO-OA	297
	F 1300			1985-1991	NE-22P2	298		
	F 1700			1985-1991				
	F 1900			1985-1991				
	F 2100			1985-1991				
	F 2500			1985-1991				
	F 3626			1985-1991				

FOR: PARA:	MODEL MODELO			PAG.		PAG.		
<b>DAF</b> ®	FA 1100 DT			-19-	DAV-1	297	RO-4D	298
	FA 1300 DNT			-19-	DAV-1P	297	RO-4I	298
	FA 1300 DT			-19-	LAS-V	297		
	FA 2100			1982-1984				
	FA 2500			1982-1984				
	FA 2500			-19-	CHR-3	297	FO-OA	297
					CHR-3P	297		
					NE-3	297		
					NE-3P	297		
					NE-3P1	298		
					NE-3P2	298		
	F-FA-V- 600			1985-1991	NE-11	298	FO-OA	297
	F-FA-V- 800			1985-1991	NE-11P	298		
					WAS-6	298		
					WAS-6P			
	F-FA-V-1000			1985-1991				
	FT 75.270R			-19-	CHR-3	297	VO-VB	298
	FT 85.360W			-19-	NE-22P	298	VO-VBP	298
	FT 3300			-19-				
	SERIE FT			1991-	CHR-3	297	VO-VB	298
					CHR-3P	297	VO-VBP	298
	V 400			1991-	NE-11	298	NE-11	298
	V 600			1991-	NE-11P	298	NE-11P	298
	VARIOUS MODELS			-	NE-3D	297	NE-3D	297
					WAS-4	298		
					WAS-4P			
<b>DIAMOND REO</b> ®	VARIOUS MODELS			-	HUD-1	298	HUD-1	298
<b>FIAT IVECO</b> ®	30.8			-1991	FI-11	300	FI-11	300
	35.10			-1991	FI-11P	300	FI-11P	300
	35.8			-1991	FI-1P	299	FI-1P	299
					FIS-1D	300	FIS-1D	300
	40.10			-1991	FI-11	300	FI-11	300
	49.10			-1991				
	30.8			1992-	FI-12	300	FI-11	300
	35.10			1992-	FI-12P1	300	FI-11P	300
	35.12			1992-				
	35.8			1992-				
	40.10			1992-				
	40 NC 35			-19-	AF-9D	299	AF-5D	299
	40.8 F 8			-19-	AF-9DP	299	AF-5I	299
					AF-9I	299	AF-6D	299
					AF-9IP	299	AF-6I	299
	50 NC			-19-	AF-9D	299	IMS-3	301
	55 NC			-19-	AF-9DP	299	IMS-3P	301
	80 NC			1979-	AF-9I	299	IMS-5	301
	55			-19-	AF-9IP	299	IMS-5P	301

Camión  
Kamioi  
Camions

Lkw  
Camión  
Ciężarowych

FOR: PARA:	MODEL MODELO			PAG.		PAG.
FIAT IVECO ®	79.13 F 13			1979-		
	79.14 F 14			1979-		
	80.13 F 13			1979-		
	95.14 F 14			1979-		
	100			1979-		
	50.9		FI-6I	300	IMS-3	301
	60.11		FI-6IP1	300	IMS-3P	301
	65.12		FI-9I	300	IMS-5	301
	79.14		FI-9IP	300	IMS-5P	301
	80.14			1994		
	95.14			1994		
	109.14			1994		
	110.17			1994		
	110 NC		AF-8D	299	IMS-3	301
	110 P		AF-8DP	299	IMS-3P	301
	150.20		AF-8I	299	IMS-5	301
	160 NC		AF-8IP	299	IMS-5P	301
	170 NC 35		AF-9D	299		
	100		AF-9DP	299		
	110		AF-9I	299		
	130		AF-9IP	299		
			FEM-1D	299		
			FEM-1I	299		
	115.17 D T.		FI-6I	300	FI-6I	300
	115.17 H		FI-6IP	300	FI-6IP	300
	145.17 H T.			1989		
	175.24			1989		
	135			1989		
	150 R.20		AF-9D	299	FI-5D	300
	150 T.20		AF-9DP	299	FI-5I	300
	159.20		AF-9I	299	IMS-3	301
	190 T.30		AF-9IP	299	IMS-3P	301
	190.26			1989	IMS-5	301
	190			1989	IMS-5P	301
	180.26		AF-7I	299	IMS-3	301
	180.26 T		AF-7IP	299	IMS-3P	301
	190.38		AF-9D	299	IMS-5	301
	190.38 T		AF-9DP	299	IMS-5P	301
	190.F 35		AF-9I	299		
	190.H 35		AF-9IP	299		
	180			1989		
	190 PC 26		BH-2	299	PRE-1I	301
	260			19-		
	190 TURBOS.		AU-1	299	FI-1I	300
			AU-HV	299	FI-1IP	300
			AU-HVP	299		
			BL-2	299		
			FIS-1D	300		
	190.26		FI-1I	300	NE-1	301
	190.30		FI-1IP	300	NE-1P	301
	190.32			1991		
	190.36			1991		
	190.42			1991		
	190.48			1991		
	240.26			1991		
	240.32			1991		
	240.36			1991		

FOR: PARA:	MODEL MODELO			PAG.		PAG.
FIAT IVECO ®	280.36			1991		
	330.30			1991		
	330.35			1991		
	330.36			1991		
	190.26		FI-1I	300	FI-1I	300
	190.30		FI-1IP	300	FI-1IP	300
	190.32			1992		
	190.36			1992		
	190.42			1992		
	190.48			1992		
	240.26			1992		
	240.32			1992		
	240.36			1992		
	280.36			1992		
	330.30			1992		
	330.35			1992		
	330.36			1992		
	190.30		AF-7I	299	FI-5D	300
			AF-7IP	299	FI-5I	300
			AF-9D	299	IMS-3	301
			AF-9DP	299	IMS-3P	301
			AF-9I	299	IMS-5	301
			AF-9IP	299	IMS-5P	301
			BL-2	299		
	190.33 T.S.		VO-VB	301	FI-1I	300
	190.38 T.S.		VO-VBP	301	FI-1IP	300
	190.42 T.S.			1988		
	242 E-15		FI-3D	300	IMS-3	301
	242 E-18		FI-3DP3	300	IMS-3P	301
					IMS-5	301
					IMS-5P	301
	242.15		CT-1	299	IMS-3	301
	242.18		CT-1P	299	IMS-3P	301
			CT-3	299	IMS-5	301
			CT-3P	299	IMS-5P	301
	260.36		FI-1I	300	VO-VB	301
			VO-1	301		
	260.48		FI-1IP	300	VO-VBP	301
	330 F 35		VO-VB	301	IMS-3	301
	330.26		VO-VBP	301	IMS-3P	301
	330.30			1988	IMS-5	301
	330.32			1988	IMS-5P	301
	330.35			1988		
	330.36			1988		
	619.3A		AF-9D	299	AF-9D	299
	619.N		AF-9DP	299	AF-9DP	299
	642		AF-9I	299	AF-9I	299
			AF-9IP	299	AF-9IP	299
	643		AF-9D	299	AF-5D	299
	672		AF-9DP	299	AF-5I	299
			FEM-1D	299	AF-6D	299
			FEM-1I	299	AF-6I	299
	VARIOUS MODELS		FI-3	300	FI-3	300
			FI-3DP4	300	FI-3DP4	300
			FI-3DP5	300	FI-3DP5	300
	VARIOUS MODELS		FI-6IP2	300	FI-6IP2	300

FOR: PARA:	MODEL MODELO			PAG.		PAG.
FIAT IVECO ®			FI-6IP4	299	FI-6IP4	299
FORD (USA) ®	CARGO		1986-	NE-11P3	303	NE-11P3 303
	VARIOUS MODELS		-	MAZ-14D	303	MAZ-14D 303
				MAZ-1D	303	MAZ-1D 303
				MAZ-1I	303	MAZ-1I 303
				NE-1I	303	LF-WR 303
				NE-11P	303	
				FO-11D	302	FO-11D 302
				FO-20D	303	FO-20D 303
				NE-1I	303	NE-1I 303
				NE-11P	303	NE-11P 303
				FO-15D	302	FO-15D 302
				FO-15DP	302	FO-15DP 302
FORD ®	A 0406		-19-	FO-E-TC	301	UN-FT 302
						UN-FS 302
	A 0406 R		-19-	FO-E-TCP	302	
	A 0509		-19-	FO-TX	302	
	A 0509 P		-19-	FO-TXP	302	
	A 0609		-19-	UN-FT	302	
	D 710 CUSTOM		-19-			
	CARGO		1986-1991	NE-11P3	302	
	TRANSCONTIN.		-19-	LF-6	302	LAS-R 302
						LAS-V 302
						UN-FS 302
	VARIOUS MODELS		-	ME-S	302	ME-S 302
				ME-SP	302	ME-SP 302
FREIGHTLINER ®	VARIOUS MODELS		-	BS-4D	303	BS-4D 303
				HUD-1	303	HUD-1 303
				YA-8D	303	YA-8D 303
				YA-27D	303	YA-27D 303
	VARIOUS MODELS		1994-2004	AMM-1	303	AMM-1 303
GM (CHEVROLET) ®	VARIOUS MODELS		-	MIT-1I	303	MIT-1I 303
				MIT-1IP	303	MIT-1IP 303
				MIT-2I	304	MIT-2I 304
				MIT-2IP	304	MIT-2IP 304
				TOYO-2	304	TOYO-2 304
GM (GMC) ®	MEDIUM		1984-1986	DAT-6D	304	DAT-6D 304
	TRUCK W4		1984-1986	DAT-6DP1	304	DAT-6DP1 304
	MEDIUM		1986-	ISU-2	304	ISU-2 304
	TILTMASER		1986-			
	TRUCK W4		1986-			
GMC ®	TILTMASER NQR		2000-2011	GM-5	304	GM-5 304
				GM-5P	304	GM-5P 304
	TILTMASER W5		1998-2011	GM-5	304	GM-5 304
	TILTMASER W6		1998-2001	GM-5P	304	GM-5P 304
	TILTMASER W7		1998-2007			
HINO ®	HEAVY DUTY		2005-2009	HIN-1		HIN-1

FOR: PARA:	MODEL MODELO			PAG.		PAG.
HINO ®	VARIOUS MODELS		-	TOYO-K1	304	TOYO-K1 304
				TOYO-K1P	304	TOYO-K1P 304
ISUZU ®	NKR		-19-	MIT-15P	305	MIT-15P 305
	NPR		-19-			
	NQR		-19-			
	TILTMASER		1986-1988	DAT-6D	305	DAT-6D 305
	W4-W5 (S.N)		1986-1988	DAT-6DPI	305	DAT-6DPI 305
				ISU-1	305	ISU-1 305
				ISU-2	305	ISU-2 305
				MIT-1I	305	
				MIT-1IP	305	
IVECO ®	VARIOUS MODELS		-	FI-6IP3	305	FI-6IP3 305
KENWORTH ®	MIDRANGER		1988-	NE-1I	305	NE-1I 305
				NE-1IP	305	NE-1IP 305
				FO-PN	305	
MACK ®	MIDLINER		1982-	BH-1	306	RO-4I 306
				BH-1P	306	
				DAV-1	306	
				DAV-1P	306	
	VARIOUS MODELS		-	BS-1I	306	BS-1I 306
				YA-11D	306	YA-11D 306
				AMM-1	305	AMM-1 305
				MAK-1	306	MAK-1 306
				BAS-4	306	BAS-4 306
MAGIRUS DEUTZ ®	90 M 5.3		-19-	BH-1	306	RO-4D 307
	90 M 6.0		-19-	BH-1P	306	RO-4I 307
				LAS-R	306	
				LAS-V	306	
	90 M 6.6		-19-			
	90 M 7		-19-			
	90 M 9		-19-			
	130 M 11		-19-			
	130 M 13		-19-			
	130 M 16		-19-			
	130 M 9		-19-			
	160 M 13		-19-			
	260		-19-	BH-2	306	PRE-1I 306
	360 D 18		-19-			
MAN ®	6.100 F		-19-	VO-R	307	VO-R 307
	6.90 F		-19-	VO-RP	307	VO-RP 307
				BL-2	307	
				FO-PN	307	
	8.136 F		-19-	HU-SC	307	
	8.90 F		-19-			
	9.136 F		-19-			
	9.136 FAE		-19-			
	9.150 F		-19-			
	10.136		-19-			
	10.150 F		-19-			

Camión  
Kamioi  
Camions

Lkw  
Camión  
Ciężarowych

FOR: PARA:	MODEL MODELO			PAG.		PAG.
MAN ®	9.136	-19-				
	12.170	-19-	BH-1	307	HU-MN	307
	12.192 F-FT	-19-	BH-1P	307	HU-MNP	307
	12.192 FKT	-19-				
	12.232 FT	-19-				
	14.192 F	-19-				
	14.232 FKT	-19-				
	14.232 FT	-19-				
	17.232 F	-19-				
	18.272 FTI	-19-				
	19.240 F	-19-				
	19.262 F	-19-				
	19.321 F-F/2	-19-				
	19.322 F-FK	-19-				
	19.322 FLT	-19-				
	19.361 F-FT	-19-				
	19.361-T	-19-				
	19.363 F	-19-				
	19.372 FAK	-19-				
	19.422 F-FT	-19-				
	19.462 F	-19-				
	19.502 F-FLT	-19-				
	22.361	-19-				
	24.362	-19-				
	25.372 FNL	-19-				
	25.422 FNL	-19-				
	33.222 DF	-19-				
	33.240	-19-				
	33.281-T	-19-				
	33.292	-19-				
	33.362	-19-				
	33.365	-19-				
	33.372 DF	-19-				
	33.372 DFA	-19-				
	33.422 DF	-19-				
	33.422 DFA	-19-				
	40.440	-19-				
	41.372 VFK	-19-				
	41.422 VFK	-19-				
	33.320	-19-	BH-1	307	HU-SX	307
			BH-1P	307		

MERCEDES (ARGENTINA) ®	VARIOUS MODELS	-	ME-9P	307	ME-9P	307
			ME-13DP	308	ME-13DP	308
			ME-14P	308	ME-14P	308
	SPRINTER	1995-	ME-HMP	308	ME-HMP	308
	SPRINTER	2000-	ME-HMLP	308	ME-HMLP	308

MERCEDES ®	VARIOUS MODELS	-	ME-L	308	ME-L	308
			ME-S	308	ME-S	308

MITSUBISHI ®	FUSO	-1985	MIT-2I	308	MIT-2I	308
			MIT-2IP	308	MIT-2IP	308
	FUSO	1985-	MIT-10	308	MIT-10	308
			MIT-11D	308	MIT-11D	308
			MIT-9	308	MIT-9	308

FOR: PARA:	MODEL MODELO			PAG.		PAG.
---------------	-----------------	--	--	------	--	------

NISSAN ®	L.35	-1993	DAT-6	309	DAT-6	309
	M 115.17	-1993	DAT-6P	309	DAT-6P	309
	L.35.08	-1993	CHR-3	308	DAT-6	309
			NE-22P	309	DAT-6P	309
	L.70.09	-1993	CHR-5	308	DAT-6	309
	L.80.14	-1993			DAT-6P	309
	MODELOS	1980-	DAT-12	309	DAT-12	309
			DAT-6	309	DAT-6	309
			DAT-6P	309	DAT-6P	309
	VARIOUS MODELS	-	ROS-2	309	ROS-2	309

PEGASO ®	1236	-19-	CHR-5	309	IMS-5	309
					IMS-5P	310
			BL-2	309		
	360	-19-	AU-1	309	CHR-3	309
			AU-HV	309	CHR-3P	309
			AU-HVP	309	NE-22P1	310
			VO-HV	310		
			VO-HVP	310		
	620	-19-	CHR-3	309	VO-VB	310
			CHR-3P	309	VO-VBP	310
	VARIOUS MODELS	-	ROS-2	310	ROS-2	310
			BL-6	309	BL-6	309
			BL-6D	309	BL-6D	309

PIAGGIO ®	APE CAR	-19-	AF-9D	310	FAB-1	310
	APE CAR P3	-19-	AF-9DP	310		
	P 601	-19-	AF-9I	310		
			AF-9IP	310		
			FAB-1	310		
			FEM-1D	310		
			FEM-1I	310		
	APE P 50	-19-	FEM-1D	310		
	APE TM P 50	-19-	FEM-1I	310		
			NE-6	310		
			NE-6P	310		
	APE TM 703	-19-	AF-9D	310	FAB-1	310
	NICA 125	-19-	AF-9DP	310		
			AF-9I	310		
			AF-9IP	310		
			FAB-1	310		

RENAULT SAVIEM ®	B 70.35	-1987	CHR-3	311	VA-7	312
					VA-10	312
	B 70.45	-1987	CHR-3P	311		
	B 90.35	-1987	LMP-5	311		
			LMP-5P1	311		
			NE-22P	311		
	B 70.45	1988-1992	CHR-3	311	NE-28	311
	B 80.45	1992-	NE-22P	311		
	B 90.45	1988-1992				
	B 90.50	1988-1992				
	B 110.150	1992-				
	B 110.35	1992-				

FOR: PARA:	MODEL MODELO			PAG.		PAG.
---------------	-----------------	--	--	------	--	------

RENAULT SAVIEM ®	G 300 G	-1994	DAV-1	311	LAS-R	311
	G 330 GV	-1994	DAV-1P	311	LAS-V	311
			PJ-1	312		
			PJ-2	312		
			PJ-2P	312		
	G 340 TI	-1994	NE-3	311		
	GR 305	-1994	NE-3P	311		
	GR 305 TURBO	-1994	NE-3P1	311		
	R 310	1984-	NE-3P2	311		
	R 360	1984-1985				
	R 360 TURBO	1984-				
	GB 119	1986-	DAV-1	311	RO-4D	312
	GB 231 TURBO	1986-	DAV-1P	311	RO-4I	312
			LAS-R	311		
			LAS-V	311		
	GC 231 TURBO	1986-	DAV-1P	311	RO-4I	312
	GF 231 TURBO	1986-				
	GR 231 TURBO	1986-				
	JK 50-60	-19-	BH-1	310	RO-15	312
	JK 75-90	-19-	BH-1P	310	RO-4D	312
	JK 110-115	-19-			RO-4I	312
	JP 11	-19-	BH-1	310	RO-4D	312
			LAS-R	311		
			LAS-V	311		
	JP 13	-19-	BH-1P	310	RO-4I	312
	JP 13 TU	-19-				
	JP 115	-19-				
	M 160.12	-1994	NE-3	311	VA-10	312
	M 200.12	-1994	NE-3P	311		
	M 230.12	-1994	NE-3P2	311		
			RO-4D	312		
			RO-4I	312		
	M 230.13T	-1994	NE-3	311	VA-10	312
	M 230.16	-1994				
	MASTER P35 D	-1987	CHR-3	311	VA-7	312
	MASTER T30 D	-1987	CHR-3P	311		
			NE-28	311		
	MASTER T35 D	-1987	LMP-5	311		
			LMP-5P1	311		
			NE-22P	311		
	MASTER T30 D	1987-	CHR-3	311	NE-28	311
	MASTER T35 D	1987-	NE-22P	311		
	MASTER TURBO	1987-				
	R 350 TI	-1992	NE-3	311	VA-10	312
	R 365	-1992	NE-3P	311		
	R 380	-1992	NE-3P2	311		
	R 385	-1994				
	R 420	-1992				
	RI 357	-1992				
	R 360	1985-1987	NE-3	311	LAS-R	311
	R 370	1985-1987	NE-3P	311	LAS-V	311
	R 370 T U8 T	1985-1987	NE-3P2	311		
			RO-7D			
	S 100.06	-1994	NE-3	311	RO-4I	312
	S 100.07	-1994	NE-3P	311		
	S 100.08 T.	-1994	NE-3P2	311		
			NE-28	311		

FOR: PARA:	MODEL MODELO			PAG.		PAG.
---------------	-----------------	--	--	------	--	------



RENAULT SAVIEM ®			PJ-2	312		
			PJ-2P	312		
			LAS-R	311		
	S 150	-1994				
	S 160.08 T	-1994				
	S 160.09	-1994				
	S 170.13	-1994				
	S 170.145	-1994				
	SG2/35-40	-19-	BH-1	310	LAS-R	311
	SG3/35-40	-19-	BH-1P	310	LAS-V	311
			RO-17	312		
	SG4/35-40	-19-	BH-1P	310	LAS-V	311
	TRAFFIC	-1987	CHR-3	311	RO-17	312
			CHR-3P	311		
			NE-22P	311		
	TRAFFIC	1988-	NE-19	311	NE-28	311
			NE-19P	311		
	VARIOUS MODELS	-	NE-3D	311	NE-3D	311



ROVER ®	LEYLAND ROAD	-19-	NE-11	312	LAS-V	312
			NE-11P	312		
			UN-IFS	312		

SCANIA ®	112 H	-1987	VO-VB	313	WIT-1	313
	142 H 8V	-1987	VO-VBP	313		
	P 82	-1987				
	P 92	-1987				
	P 93 H-HL	1988-				
	P 93 ML	1988-				
	P 113 EL	1988-				
	R 112 H	-1987				
	R 113 E-ES	1988-				
	R 113 HL-HS	1988-				
	R 113 M	1988-				
	R 113 MA	1988-				
	R 142 E	-1987				
	R 142 H	-1987				
	R 142 H 8V	-1987				
	R 142 M	-1987				
	R 143 EL-ES	1988-				
	R 143 HL-HS	1988-				
	R 143 MA	1988-				
	140 8V T	-19-	BH-2	312	HU-SX	313
	411 8V	-19-	FO-FR	313		
	110	-19-	FO-FRP	313		
	111	-19-	WAS-2P	313		
	141	-19-				
	R-144 NA	1996-	HU-2P	313	HU-2P	313
	10 S 14	-19-	VO-VB	314	AKS-1	313
	17 S 18	-19-	VO-VBP	314		
			BL-2	313		
	19 S 31	-19-	NE-25	313		
	19 S 37	-19-				
	26 S 31	-19-				
	32 S 31	-19-				

Camión  
Kamioi  
Camions



Lkw  
Camión  
Ciężarowych



FOR: PARA:	MODEL MODELO			PAG.		PAG.
<b>TATA</b> ®	VARIOUS MODELS	-19-	ME-VA	314	ME-VA	314
<b>TRUCK (USA)</b> ®	VARIOUS MODELS	1995-	GM-14	314	GM-14	314
			GM-14P	314	GM-14P	314
			GM-25	314	GM-25	314
			GM-25P	314	GM-25P	314
<b>VOLKSWAGEN</b> ®	VARIOUS MODELS	-	VO-VB	314	VO-VB	314
			VO-VBP	314	VO-VBP	314
			VO-HV	314	VO-HV	314
			VO-HVP	314	VO-HVP	314
			VO-VB	314	VO-VB	314
			VO-VBP	314	VO-VBP	314
<b>VOLVO</b> ®	F 6	-19-	NE-12	315	NE-12	315
	F 7	-19-	NE-12P	315	NE-12P	315
			NE-9	315		
			NE-9P	315		
			WAS-1	315		
	F 10	-19-				
	F 12 T 6	-19-				
	F 1020 T 6	-19-	NE-3	315	NE-12	315
			NE-3P	315	NE-12P	315
			NE-3P2	315		
			NE-9	315		
			NE-9P	315		

FOR: PARA:	MODEL MODELO			PAG.		PAG.
<b>VOLVO</b> ®			WAS-1	315		
	FL 6 INTER.	-19-	NE-12	315	RO-4D	315
	FL 7 INTER.	-19-	NE-12P	315	RO-4I	315
			LAS-R	314		
			LAS-V	314		
	FL 10 INTER.	-19-	NE-12P	315	RO-4I	315
	FL 12 INTER.	-19-				
	FL 611	-19-	NE-12	315		
	FL 614	-19-	NE-12P	315		
	FL 616	-19-				
	VARIOUS MODELS	-	NE-1	315	NE-1	315
			NE-1P	315	NE-1P	315
			NE-3D	315	NE-3D	315
<b>WHITE</b> ®	VARIOUS MODELS	-1980	BS-4D	316	BS-4D	316
			HUD-1	316	HUD-1	316
	VARIOUS MODELS	-1989	BS-2	316	BS-2	316
			BS-5	316	BS-5	316
	VARIOUS MODELS	1980-1990	AMM-2	315	AMM-2	315
	VARIOUS MODELS	1980-2007	AMM-1	315	AMM-1	315

Motocicleta  
Motozikleta  
Motos

Motorrad  
Motociclos  
Motocykli

FOR: PARA:	MODEL MODELO			PAG.		PAG.
<b>APRILIA</b> ®	AFI 50	1986-1991	ZA-1	317	ZA-1	317
	AFI 125	1986-1991	ZA-1P	317	ZA-1P	317
	AS 125 R.V.	1986-1991				
	ET 50	1986-1991				
	ETX 125 PV	1986-1991				
	ETX 350	1986-				
	ETX 600	1986-				
	MX 125 A	1986-1991				
	RED ROSE 50	1986-1990				
	RED ROSE 125	1986-1990				
	AMICO	1996-1998	ZA-6DPI	317	ZA-6DPI	317
	CLASSIC 125	1996-1999				
	GULLIVER	1995-1998				
	LEONARDO	1996-2004				
	MOTO 6.5	1996-2002				
	PEGASO	1997-2004				
	PEGASO 3-650	1996-				
	RALLY	1996-2004				
	RX 50	1996-2004				
	SR 50	1996-2004				
	AMICO 50	1992-	ZA-4DP	317	ZA-4DP	317
	EUROPA 50	1992-				
	FUTURA 50AE	1992-				
	PEGASO 50	1992-				
	PEGASO 600	1990-				
	PEGASO 650	1990-				
	RED ROSE 50	1992-				
	RS 50 EXTRE.	1992-				
	RX 50	1992-1996				
	SR 50	1992-1996				
	AREA 51	1998-2000	ZA-6DPI	317	ZA-6DPI	317
	CLASSIC 50	1996-1999				
	ETV 1000 C.	2001-2007				
	MOJITO	1999-2008				
	MX	2002-2006				
	RS	1996-2005				
	RST FUTURA	2000-2003				
	RSV 1000	1998-2005				
	SCARABEO	1993-				
	SL 1000 F.	2000-2003				
	SONIC 50	1998-2008				
	SPORTCITY	2004-				
	SR 125-150	1999-2001				
	ATLANTIC 125	2003-	ZA-9P1	317	ZA-9P1	317
	CLIMBER 280	1994-	ZA-4DP	317	ZA-4DP	317
	EUROPA 125	1994-				
	FUTURA 50	1990-1991				
	PEGASO 125	1994-				
	RED ROSE 125	1994-				
	RX 125 EXT.	1994-				
	RX 125 REP.	1994-				
	SIX DAYS RX	1990-1991				
	TUAREG R. 50	1994-				
	EUROPA 125AE	1992-	ZA-1	317	ZA-1	317
	EXTREMA 125	1993-	ZA-1P	317	ZA-1P	317
	PEGASO 125	1993-1994				
	RED ROSE 125	1993-1994				
	RX 125	1992-				
	TUAREG 125	1986-1991				

FOR: PARA:	MODEL MODELO			PAG.		PAG.
<b>APRILIA</b> ®	FILO GT 4L	-19-	AF-8D	317		
	MX 250	-19-	AF-8DP	317		
	RC 250	-19-	AF-8I	317		
			AF-8IP	317		
			FEM-2D	317		
			FEM-2I	317		
	FUTURA 50AE	1990-1991	ZA-13P	317		
	RX 50	1990-1991				
	FUTURA 125	1990-1991	ZA-2P	317		
	REPLICA 50	1990-1991				
	RALLY 125	1990-1991	ZA-1	317	NE-8	317
	RX 125	1990-1991	ZA-1P	317		
	RED ROSE 50	1990-1991	FI-1I	317	ZA-1	317
			FI-1IP	317	ZA-1P	317
			ZA-2P	317		
	TUAREG 125	1992-	ZA-2P	317	ZA-2P	317
	TUAREG 250	1986-	ZA-1	317	NE-8	317
	TUAREG 350	1986-	ZA-13P	317		
	TUAREG 600	1986-	ZA-1P	317		
	VARIOUS MODELS	2001-	ZA-9P2		ZA-9P2	
<b>ATALA</b> ®	BYTE AT10-50	1996-	ZA-4DP	317	ZA-4DP	317
	GREEN	1996-				
	HAKER	1996-				
<b>BENELLI</b> ®	124	-19-	FEM-ID	317		
	125 TURISMO	-19-	FEM-II	317		
	125 SPORT	1982-1983			NE-8	318
	125 SPORT	1983-1984	FEM-2D	317	NE-6	317
	T 125	-19-	FEM-2I	317	NE-6P	318
	125 SPORT	1984-	FEM-2D	317	NE-8	318
	125 TURISMO	1984-	FEM-2I	317		
	250 2C	-19-			ZA-1	318
	304 4C	-19-			ZA-1P	318
	354	-19-				
	654	-19-				
	750 SEI	-19-				
	900 SEI	-19-				
	EXPORT 3V	-19-			ZA-1	318
	G2	-19-			ZA-1P	318
	MAGNUM 3V	-19-				
	MOTORELLA 50	-19-				
	LASER	-19-			ZA-1	318
	S 50	1985-			ZA-1P	318
	S 125	-19-				
<b>BETA</b> ®	50 CC	-1993	AF-5I	318	ZA-1	318
					ZA-1P	318
	ALP	-19-	ZA-9P1	318		
	RR	2005-				
	CHRONO	1995-	ZA-4DP	318		
	CHRONO 502	1995-				
	QUADRA	1995-				
	TEMPO	1995-				
	KR 50	-19-	FAB-1	318	FAB-1	318
	KR 125	-19-				
	KR 250	-19-				



Motocicleta  
Motozikleta  
Motos

Motorrad  
Motociclos  
Motocykli

FOR: PARA:	MODEL MODELO			PAG.		PAG.
---------------	-----------------	--	--	------	--	------

<b>BETA</b>	VRS 50	-19-				
	QUADRA	1996-	ZA-6DPI	318	ZA-6DPI	318
	TEMPO	1996-				

<b>BICICLETTA- CYCLES</b>	MOD.DANES DK	-19-			AS-17D	318
	MOD.SUECO S	-19-			AS-21	318
					AS-21D	318
					AS-2D	318
					AS-2I	318
	RALEIGH	-19-			LF-2	319
					UN-FP	319
	VARIOUS MODELS	-	AS-21DP	318	AS-21DP	318
			AS-21P		AS-21P	

<b>BIMOTA</b>	GPI 1	1990-	ZA-1	319	ZA-1	319
			ZA-1P	319	ZA-1P	319
	HB 2	-19-	NE-6	319	NE-6	319
			FAR-1D	319	FAR-1D	319
	HB 3	-19-	NE-6P	319	NE-6P	319
			FAR-1I	319	FAR-1I	319
	HB 3/S	-19-	NE-6P	319	NE-6P	319
			FAR-1I	319	FAR-1I	319
	KB 1	-19-	SUZU-13P	319	NE-6	319
	KB 2/TT	-19-	SUZU-4I	319	NE-6P	319
			SUZU-4IP	319		
	SB 2	-19-	SUZU-13P	319		
			SUZU-4I	319		
			SUZU-4IP	319		
	SB 3	-19-	SUZU-5	319	NE-6	319
	SB 4S	-19-	SUZU-5P	319	NE-6P	319
	SB 4SP	-19-				

<b>BMA</b>	AMICA 50	-19-	AF-9D	319	UN-MRN	320
	AMICA 125	-19-	AF-9DP	320		
	AMICA 250	-19-	AF-9I	320		
	AMICA 360	-19-	AF-9IP	320		
			FEM-1D	320		
			FEM-1I	320		

<b>BMW</b>	400 RS	1984-1985	NE-6	320	NE-6	320
			NE-6P	320	NE-6P	320
	450	1984-1986	NE-7	320	NE-7	320
	650	1984-1986				
	K 1	1987-1993				
	K 75	1984-1992				
	K 75 RT	1993-				
	K 75 S	1993-				
	K 100	1984-1992				
	K 100 RS	1993-				
	K 1100 LT	1993-1994				
	K 1100 RS	1993-1994				
	R 45	1984-1986				
	R 65	1984-1992				
	R 80	1984-				
	R 80 GS	1993-				
	R 80 R	1993-				

FOR: PARA:	MODEL MODELO			PAG.		PAG.
---------------	-----------------	--	--	------	--	------

<b>BMW</b>	R 80 RT	1993-				
	R 100 GS	1993-				
	R 100 R	1993-				
	R 100 RS	1993-				
	R 100 RT	1993-				
	F 650	1994-	ZA-6DP	320		
	K 1100	1994-1995	BM-HBP1	320	BM-HBP1	320
	K 1100 LS	1994-				
	K 1100 LT	1994-				
	R 1100	1994-1995				
	R 1100 GS	1994-				
	R 1100 R	1994-				
	R 1100 RT	1994-				
	K 1100	1995-	BM-HBP1	320	BM-HBP1	320
	R 850 RT	1996-2002				
	R 1000	1995-				
	R 1100	1995-				
	R 60/6	-19-	NE-7	320	NE-6	320
	R 75/6	-19-			NE-6P	320
	R 80/7	-19-				
	R 90 S	-19-				
	R 90/6	-19-				
	R 60/7	-19-	NE-7	320	NE-6	320
			BL-2	320	BL-2	320
	R 75/7	-19-			NE-6P	320
	R 100 RS	-19-				
	R 100/7	-19-				
	R 100/S	-19-				

<b>BUELL</b>	BLAST	2000-2009	ZA-9P1	320		
	FIREBOLT	2002-2009				
	LIGHTNING	2003-2009				
	ULYSSES	2006-2009				

<b>CAGIVA</b>	125 ALETA	1986-			ZA-1	321
	COCIS 50	-1991			ZA-1P	321
	200 ELEFANT	1984-			ZA-1	321
	350 ALA	1984-1987			ZA-1P	321
	CRESTA 350	1984-1987				
	DG 350	1984-1987				
	SST 350 RL	1984-1987				
	SX 350	1984-1987				
	650	-19-	SUZU-13P	321	SUZU-13P	321
			SUZU-4I	321	SUZU-4I	321
			SUZU-4IP	321	SUZU-4IP	321
	900 ELEFANT	1997-	KAW-6P	321		
	ALETA EL.125	-19-			ZA-1	321
	RX 250	1984-			ZA-1P	321
	SST 250 ALA	1984-				
	SST 250 RL	1984-				
	SX 250	1984-				
	SXT 250	1984-				
	WMX 250	1984-				
	WMX 500	1984-				
	ALETA ORO L.	1986-	FI-6I	321	ZA-1	321
			FI-6IP2	321	ZA-1P	321
			FI-6IP3	321		

FOR: PARA:	MODEL MODELO			PAG.		PAG.
---------------	-----------------	--	--	------	--	------

<b>CAGIVA</b>	ALETA ROSA	1986-	SUZU-13P	321	ZA-1	321
	K 3	1991-1992	SUZU-4I	321	ZA-1P	321
			SUZU-4IP	321		
	AR 350	1984-1989	SUZU-13P	321	ZA-1	321
	ELEFA. 2 125	-19-	SUZU-4I	321	ZA-1P	321
	ELEFA. 2 200	-1984	SUZU-4IP	321		
	ELEFA. 2 350	1984-1989				
	ELEFA. 2 600	-19-				
	BLUES 125	-19-	FI-1	321	FI-1	321
	TAMANACO 125	-19-	FI-1P	321	FI-1P	321
	CITY	1993-1994	KAW-6P	321	KAW-6P	321
	ELEFA. 900	1992-				
	MITO	1992-				
	MITO 125	1991-1992				
	MITO CARENA.	1991-1992				
	MITO EV	1994-1995				
	MITO LAWSON	1993-				
	MITO RACING	1991-1994				
	PRIMA	1993-				
	SUPER CITY	1993-				
	CITY	1994-	ZA-8P	321	ZA-8P	321
	CITY LUCKY	1994-				
	CITY PASSING	1994-				
	SUPERCITY	1994-				
	ELEFA. 90	-1991	FI-1	321	ZA-1	321
	ELEFA. 750	-1991	FI-1P	321	ZA-1P	321
	LUCKY 350 E.	1987-1991				
	PARIS DAKAR	-1991				
	T 350 E	1987-1991				
	T4 350 R	1987-1991				
	FRECCIA 125	-19-	FI-1	321	FI-1	321
			FI-1P	321	FI-1P	321
			MER-16D	321	MER-16D	321
	FRECCIA 125	1991-1992	FI-1	321	ZA-1	321
	N 90	1991-1992	FI-1P	321	ZA-1P	321
	FULL FUN 125	-1990	FI-1	321	FI-1	321
	MITO 125	-1990	FI-1P	321	FI-1P	321
	MMX 125	-1990				
	HD 175	-19-	FEM-1D	320		
	HD 350	-19-	FEM-1I	320		
	LUCKY 350 EX	-1991	FI-1	321	ZA-1	321
	T4 350	-1991	FI-1P	321	ZA-1P	321
	T4 500 E	-1991				
	MITO RACING	1994-	KAW-6P	321	KAW-6P	321
	RIVER 600 C.	1995-	ZA-4DP	321		
	ROADSTER 125	1994-	ZA-1	321		
			ZA-1P	321		
	S.CITY 125	1992-	ZA-4DP	321	ZA-4DP	321
	SST 125	1984-	SUZU-13P	321	ZA-1	321
	SXT 125 N	1984-	SUZU-4I	321	ZA-1P	321
	W 8	1994-	SUZU-4IP	321		
	SST-SX 125	-1984	FEM-1D	320	ZA-1	321
	SST-SX 250	-1984	FEM-1I	320	ZA-1P	321
	SXT 125	1984-	SUZU-13P	321		
			SUZU-4I	321		

FOR: PARA:	MODEL MODELO			PAG.		PAG.
---------------	-----------------	--	--	------	--	------

<b>CAGIVA</b>			SUZU-4IP	321		
	TRIAL 125	-19-			CL-2I	320
	TRIAL 350	-19-			CL-3I	320
	VARIOUS MODELS	-19-	FI-6IP4	320	FI-6IP4	320
	W 12 350	1994-	ZA-1	321	ZA-1	321
			ZA-1P	321	ZA-1P	321
	W 16	1997-	ZA-1	321	ZA-1	321
			ZA-1P	321	ZA-1P	321

<b>CIMATTI</b>	GRINGO G1-4M	-19-			ZA-1	322
	GRINGO LUX	-19-			ZA-1P	322
			FAB-1	322	FAB-1	322

<b>DEMME</b>	SMILY	-19-			NE-6	322
					NE-6P	322

<b>DERBY</b>	ATLANTIS 100	2003-	ZA-9P1	322	ZA-9P1	322
	MULHACEN	2006-	ZA-9P1	322	ZA-9P1	322
	PREDATOR	1999-			ZA-9P1	322

<b>DKM-HERCULES</b>	125 G SPEC.	-19-			NE-6	322
	175 GS	-19-			NE-6P	322
	250 GS	-19-				
	505 P	-19-				
	531					

Motocicleta  
Motozikleta  
Motos

Motorrad  
Motociclos  
Motocykli

FOR: PARA:	MODEL MODELO			PAG.		PAG.
<b>DUCATI</b> ®	750 SS	1991-1992				
	851 S	1991-1992				
	851 SPORT	1991-1992				
	888 RACING	1993-				
	888 S.P.4	1991-1992				
	888 S.P.5	1993-				
	900 M	1993-				
	900 S.L.	1991-				
	900 S.S.	1991-1992				
	900 SS	1991-				
	907 i.e.	1991-1992				
	600 MONSTER	1994-2001	KAW-6P	323		
	748	1995-2003				
	750 S.SPORT	1999-2003				
	900 MONSTER	1994-2001				
	900 S.SPORT	1998-2002				
	996	1999-2004				
	ST 2	1997-2003				
	ST4	1998-2003				
	750 FI DESMO	1986-1991	FEM-1D	322	NE-8	323
			FEM-1I	322		
			FEM-2D	322		
			FEM-2I	322		
			FI-6I	322		
			FI-6IP3	323		
			ZA-1	323		
			ZA-1P	323		
			FAR-1D	322		
			FAR-1I	322		
	750 FI DESMO	1987-	ZA-13P	323	ZA-13P	323
	851 SPORT	1989-1990				
	907 i.e.	1989-1990				
	DESMO 900 SS	1989-				
	PASO 906	1989-				
	750 INDIANA	1990-1991	FI-6I	322	FI-6I	322
	750 SPORT R	1990-1991	FI-6IP3	323	FI-6IP3	323
	PASO 750 LTD	1990-1991				
	851 S	1990-1991	FI-6I	322	ZA-1	323
	900 S.S.	1990-1991	FI-6IP3	323	ZA-1P	323
	907 i.e.	1992-	ZA-4DP	323	ZA-4DP	323
	CARENATA	1991-	KAW-6P	323	KAW-6P	323
	CUPOLINO	1991-				
	INDIANA 350	1987-			ZA-1	323
	INDIANA 650	1987-			ZA-1P	323
	INDIANA 750	1987-				
	PASO 350	1987-	ZA-13P	323	ZA-1	323
	PASO 750	1987-			ZA-13P	323
					ZA-1P	323
	VARIOUS MODELS	-19-	FI-6IP4	322	FI-6IP4	322
	VARIOUS MODELS	1985-1992	FI-6IP2	322	FI-6IP2	322
<b>FANTIC MOTOR</b> ®	50.1 OASIS	1984-1991			ZA-1	324
	CABALLERO	1992-			ZA-1P	324
	CABALLERO 50	1984-1991				
	CLAN 50	1982-				
	CLUBMAN	1993-				



FOR: PARA:	MODEL MODELO			PAG.		PAG.
<b>FANTIC MOTOR</b> ®	ISSIMO	1982-				
	JOY 3V	1984-1991				
	JOY MK	1984-1991				
	JOY VK	1984-1991				
	KOALA	1993-				
	K-ROO	1992-				
	RAIDER 50.1	1984-1991				
	RAILLY 240	-19-				
	TENTER TO	1984-1991				
	TRIAL 50	1982-				
	TRIAL 201	-1991				
	TRIAL 240	-1991				
	TRIAL 241	-1991				
	TRIAL 242	-1991				
	TRIAL 245	-1991				
	TRIAL 300	-1991				
	TRIAL 301	-1991				
	TRIAL 303	-1991				
	TRIAL 305	-1991				
	TRIAL KID	1984-1991				
	TRIAL S.5	1984-1991				
	TRIAL S.7	1984-1991				
	125	1984-	ZA-1	324	ZA-1	324
	125 SPORT	1984-	ZA-1P	324	ZA-1P	324
	ISSIMO 50	1984-				
	RAIDER 50	1984-				
	RAIDER GT 50	1984-				
	SPRINTER 3V	1984-				
	SPRINTER 50	1984-				
	SPRINTER MU.	1984-				
	STRADA 50	1984-				
	ENDURO 50	1985-			NE-8	324
	RAIDER 125	-19-				
	TRIAL 50	1985-				
	TRIALMATIC50	1985-				
	GR.TUR.50 CC	-19-			NE-6	324
					NE-6P	324
	HP1 125	-19-	FI-6I	323	FI-6I	323
			FI-6IP3	323	FI-6IP3	323
			ZA-1	324	ZA-1	324
			ZA-1P	324	ZA-1P	324
	LEI 50 CC	-19-			IMS-5	323
					IMS-5P	323
	RAIDER 125LC	-19-			ZA-1	324
					ZA-1P	324
	STRADA 125	1983-	ZA-1	324	ZA-1	324
			ZA-1P	324	ZA-1P	324
	STRADA 125	1985-1988	FI-6IP2	323	FI-6IP2	323
	VARIOUS MODELS	-19-				
	TRIAL 125	-19-			NE-8	324
	TRIAL 200	-19-			ZA-1	324
					ZA-1P	324
	VARIOUS MODELS	-19-	FI-6IP4	323	FI-6IP4	323
<b>GARELLI</b> ®	BASIC 50	1985-			ZA-1	324
	BASIC2 50	1985-			ZA-1P	325



FOR: PARA:	MODEL MODELO			PAG.		PAG.
<b>GARELLI</b> ®	FORMUNO	1988-1991				
	GARY	1992-				
	GARY DUE 50	1988-1991				
	GARY UNO 50	1988-1991				
	SAHEL 50 ES	-1991				
	TEAM 3V 50	-1991				
	TEAM BIMATIC	-1991				
	TEAM MATIC	-1991				
	URKA AC-LC50	-1991				
	VIP N3V 50	-1991				
	CICLONE 50	-1986		AF-19	324	
	CICLONE 5V 5	-1986		AF-19P	324	
	EUREKA FLEX	-19-		IMS-5	324	
	JUNIOR T 50	1982-1986		IMS-5P	324	
	JUNIOR GT 50	1982-1986		ZA-1	324	
	JUNIOR K1005	-1986		ZA-1P	325	
	NOI 50	-1986				
	VIP 1-N50	-19-				
	VIP 2-N50	-19-				
	VIP 3-N50	-19-				
	VIP 4-N50	-19-				
	CICLONE 5VN	1986-1988	ZA-1	324	ZA-1	324
	CICLONE LC	1986-1988	ZA-1P	325	ZA-1P	325
	NOI BIMATIC	1987-1991				
	NOI MATIC	1987-1991				
	NOI TL 50	1987-1991				
	GRAN TURISMO	-19-			NE-6	324
					NE-6P	324
	GTA 125	-19-	FI-6I	324	FI-6I	324
			FI-6IP3	324	FI-6IP3	324
			ZA-1	324	ZA-1	324
			ZA-1P	325	ZA-1P	325
	SUPER VIP	1985-1989	AF-6D	324	ZA-1	324
	TIGER 125XLE	-19-			ZA-1P	325
	TRS 125 S.M.	-19-				
	XR 125 TIGER	-19-				
	TIGER XRD	-19-	ZA-1	324		
			ZA-1P	325		
	VARIOUS MODELS	-	JD-2		JD-2	
			FI-6IP4	324	FI-6IP4	324
<b>GILERA</b> ®	50 GSA LUS	-19-	AF-6D	325	NE-8	325
	50 TS-GSA	-19-				
	50 R1	-19-			ZA-2P	326
	50 RALLY	-19-				
	50 RC TRO.	-19-				
	50 TREND	-19-				
	50 SIOUX A	-19-	ZA-4DP	326	ZA-4DP	326
	125 APACHE	1991-				
	125 CROMO	1991-				
	125 FREE ST	-19-				
	125 GFR S.P	-19-				
	125 SIOUX	-19-				
	350 NORDWES	1993-				
	600 NORD WE	-19-				
	600 R	1993-				
	600 RC	1991-				



FOR: PARA:	MODEL MODELO			PAG.		PAG.
<b>GILERA</b> ®	RC 750 R	-19-				
	TYPHOON	-1995				
	125 CX AE	-19-	ZA-1	326	ZA-1	326
	503 AE	1993-	ZA-1P	326	ZA-1P	326
	BULLIT AE	1992-				
	BULLIT KICK	1992-				
	BULLIT MIX	1993-				
	SIOUX AE	1993-				
	125 GR1-TG1	-19-			NE-6	325
	150	-19-			NE-6P	325
	ECO 50	-19-				
	125 GRF	1993-	ZA-1	326	ZA-1	326
	125 R	1993-	ZA-1P	326	ZA-1P	326
	125 MRX	-1991	FI-1	325	FI-1	325
	125 RC	-1991	FI-1P	325	FI-1P	325
	125 SPO1	-1991				
	125 SPO2	-1991				
	125 XR2 R.	-1991				
	125 TG2	-19-	AF-6D	325	ZA-1	326
					ZA-1P	326
					FAR-1D	325
					FAR-1I	325
	200 T 4	-19-	AF-9D	325		
	200 T45	-19-	AF-9DP	325		
	CUSTOM 125	-19-	AF-9I	325		
	CUSTOM 200	-19-	AF-9IP	325		
			FEM-1D	325		
			FEM-1I	325		
	250 NGR	-19-	FI-6I	325	FI-6I	325
			FI-6IP3	325	FI-6IP3	325
					ZA-1	326
					ZA-1P	326
	350 DAKOTA	-1990	FI-6I	325	FI-6I	325
			ZA-1	326	ZA-1	326
	500 DAKOTA	-1990	FI-6IP3	325	FI-6IP3	325
			ZA-1P	326	ZA-1P	326
	500 SATURNO	-1990	ZA-2P	326	ZA-2P	326
	600 RC	-1990				
	ARIZONA 125	-19-	ZA-1	326	ZA-1	326
	ARIZONA 250	-19-	ZA-1P	326	ZA-1P	326
	RTX 125-200	-19-				
	RV 125-200	-19-				
	RX 125-200	-19-				
	CBA 50	-1991			ZA-1	326
					ZA-1P	326
	NCR 50	2006-	ZA-9P1	326	ZA-9P1	326
	NEXUS	2006-				
	RUNNER	2006-				
	RC 600 R	1991-	ZA-1	326	ZA-1	326
			ZA-1P	326	ZA-1P	326
	STORM 50	1995-	ZA-7DP	326		
	TYPHOON	1995-	ZA-7DP	326		
	VARIOUS MODELS	-	ZA-7DP1		ZA-7DP1	
			FI-6IP4	325	FI-6IP4	325
<b>HARLEY DAVIDSON</b> ®	883 SPORT.	1994-	HD-4D	326	HD-4D	326



Motocicleta  
Motozikleta  
Motos

Motorrad  
Motociclos  
Motocykli

FOR: PARA:	MODEL MODELO			PAG.		PAG.
<b>HARLEY DAVIDSON</b> ®	1200 SPORT.	1994-				
	FLH 1340 EL	-19-	HD-1	326	NE-6	326
	FLHC 1340 EL	-19-	HD-1D	326	NE-6P	326
	FLHC 1340 S.	-19-	HD-2	326	NE-8	326
	FLT 1340 TO.	-19-	HD-2D	326		
	FLTC 1340 TO	-19-	HD-3	326		
	FXB 1340 ST.	-19-	HD-3D	326		
	FXE 1340 SU.	-19-				
	FXPS 1340 SU	-19-				
	FXR 1340 SU.	-19-				
	FXS 1340 LOW	-19-				
	FXWG 1340 WI	-19-				
	XLH 1000 SP	-19-				
	XLS 1000 RO	-19-				
	SPORTSTER SERIES C	2012	HD-5		HD-5	
	STREET 500	2015	HD-7D		HD-7D	
	VARIOUS MODELS	-	BS-6	326		
			CHI-IT	326	CHI-IT	326
<b>HERCULES</b> ®	K 125	-19-	YAMA-2II	326		
			YAMA-2IIP	326		
<b>HM</b> ®	LOCUSTA	-19-	ZA-9P1	327		
<b>HONDA</b> ®	-	-	HOND-9D	327	HOND-9D	327
	125 E	1980-1982	SUZU-13P	329	NE-6	329
			FAB-1	327	FAB-1	327
	125 SILHO.	1980-	SUZU-4I	329	NE-6P	329
			SUZU-4IP	329		
	125 E	1982-	SUZU-13P	329	NE-8	329
			SUZU-4I	329		
			SUZU-4IP	329		
			FAR-1D	327		
	125 LEAD	1991-	HOND-4I	327	HOND-4I	327
			HOND-4IPI	327	HOND-4IPI	327
	125 S	1980-	SUZU-13P	329	NE-6	329
	125	1980-	SUZU-4I	329	NE-6P	329
			SUZU-4IP	329		
	125 VISION	-19-	SUZU-13DP	329	SUZU-13DP	329
			SUZU-4D	329	SUZU-4D	329
			SUZU-4DP	329	SUZU-4DP	329
	200 R	-1989	HOND-19	328	HOND-19	328
			HOND-19D	328	HOND-19D	328
			HOND-19DP	328	HOND-19DP	328
			HOND-19P	328	HOND-19P	328
			HOND-4D	327	HOND-4D	327
			HOND-4DP	327	HOND-4DP	327
			HOND-4DP2	327	HOND-4DP2	327
			HOND-4I	327	HOND-4I	327
			HOND-4IP	327	HOND-4IP	327
	350 FOUR	1979-1981	HOND-7I	327	NE-6	329
	500 FOUR	1979-			NE-6P	329
	350 FOUR	1981-	HOND-4D	327	NE-6	329
			HOND-4DP	327	NE-6P	329
			HOND-4DP2	327		



FOR: PARA:	MODEL MODELO			PAG.		PAG.
<b>HONDA</b> ®	400 CBF	1979-	HOND-22D		HOND-22D	
			HOND-3I	327	NE-6	329
					NE-6P	329
	400 FOUR	1981-1982	HOND-4D	327	NE-6	329
	CB 750 K	1980-	HOND-4DP	327	NE-6P	329
	CM 400 T	1981-1982	HOND-4DP2	327		
	500 CBT	-	HOND-22D		HOND-22D	
	CB 550 F	1979-				
	CB 750 F	1979-				
	500 CBT	-19-	HOND-3I	327	NE-6	329
					NE-6P	329
	500 FOUR	1976-1979	HOND-49	329	NE-6	329
					NE-6P	329
			HOND-49	329	HOND-49	329
	500 FOUR K	1979-	HOND-4D	327		
			HOND-4DP	327		
			HOND-4DP2	327		
	500 R	1983-	VO-VBP1	329	VO-VBP1	329
	500 R CROSS	1982-	HOND-4D	327	NE-8	329
	CB 750 C	1979-	HOND-4DP	327		
	CB 900 B.	1982-	HOND-4DP2	327		
	CB 900 F	1982-				
	CB 900 FII	1982-				
	CB 1100 R	-19-				
	CBR 250 F	1986-				
	CBX 400 F	1982-				
	CBX 400 FC	1984-				
	CBX 400 FII	1984-				
	FT 500	1983-1984				
	RAVEL 250	1986-				
	REBEL 250	1986-				
	XL 500 R	1982-1984				
	XL 500 S	1982-				
	XR 500 R	1982-1984				
	600 PROA.	1985-1991	HOND-4D	327	HOND-4D	327
	600 VTR.	1985-1991	HOND-4DP	327	HOND-4DP	327
	XL 600	1985-1991	HOND-4DP2	327	HOND-4DP2	327
	XL 600 LM	1985-1991	HOND-4I	327	HOND-4I	327
	XL 600 R	1985-1991	HOND-4IP	327	HOND-4IP	327
	XL 600 RM	1985-1991				
	XL 600 RX	1985-1991				
	600 R	1983-	VO-VBP1	329	VO-VBP1	329
	600 V.T.	1992-	HOND-4D	327	HOND-4D	327
	NTV 650	1992-1996	HOND-4DP1	327	HOND-4DP1	327
	NX 650 D	1983-	HOND-4DP2	327	HOND-4DP2	327
	VFR 750	1986-1989				
	VT 600	1989-				
	600 VT.R.	1990-	HOND-4I	327	HOND-4I	327
	CBR 600 F	1987-	HOND-4IPI	327	HOND-4IPI	327
	CBR 1000	1991-1992				
	VF 750 C	1990-				
	VFR 750 FK	1990-1991				
	VFR 750 FL	1990-1991				
	VFR 750 P.	1990-1991				
	VFR 750 R	1990-1991				
	XRV 750 A.	1992-				
	650 G.W.	1983-1991	HOND-4D	327	HOND-4D	327



FOR: PARA:	MODEL MODELO			PAG.		PAG.
<b>HONDA</b> ®	ASPENCADE	-1991	HOND-4DP	327	HOND-4DP	327
	CB 250 N	1982-1985	HOND-4DP2	327	HOND-4DP2	327
	CB 250 RS	1982-1985				
	CB 550	1982-				
	CBR 1000	-1991				
	CBX 1100 6C.	-19-				
	CL 250 N	1982-1985				
	CL 250 S	1982-1985				
	CM 250 C	1982-1985				
	ENTERSTAT	-1991				
	G.WING 1.2	-1991				
	GL 500	1982-				
	ST 1100 PE	1991-				
	VT 500	1983-1984				
	X 400 R	1986-				
	750 AFRICA	1991-	HOND-19	328	HOND-19	328
			HOND-19D	328	HOND-19D	328
			HOND-19DP	328	HOND-19DP	328
			HOND-19P	328	HOND-19P	328
			HOND-4D	327	HOND-4D	327
			HOND-4DP1	327	HOND-4DP1	327
			HOND-4DP2	327	HOND-4DP2	327
	750 FOUR	1979-	HOND-4D	327		
			HOND-4DP	327		
			HOND-4DP2	327		
			HOND-4I	327		
			HOND-4IP	327		
	750 RXLV	1985-	HOND-4I	327	HOND-4I	327
	750 XLV	1985-	HOND-4IP	327	HOND-4IP	327
	1100 GOLD W.	-19-	HOND-4D	327		
	CB 750 F.	1980-	HOND-4DP	327		
	CB 750 FII	1981-	HOND-4DP2	327		
	1200 G.W.	-1991	HOND-4D	327	HOND-4D	327
			VO-VBP1	329	VO-VBP1	329
	GL 1200	-1991	VO-VBP1	329	VO-VBP1	329
			HOND-4DP	327	HOND-4DP	327
			HOND-4DP2	327	HOND-4DP2	327
	GL 1500	-1991	VO-VBP1	329	VO-VBP1	329
			HOND-4DP	327	HOND-4DP	327
			HOND-4DP2	327	HOND-4DP2	327
	GX 1200 DL	-1991	VO-VBP1	329	VO-VBP1	329
			HOND-4I	327	HOND-4I	327
			HOND-4IP	327	HOND-4IP	327
	BIG RED 125	1986-	HOND-19	328	HOND-19	328
	NH 125 PEAD	1986-	HOND-19D	328	HOND-19D	328
	SPACY	-19-	HOND-19DP	328	HOND-19DP	328
	XL 125	1984-1986	HOND-19P	328	HOND-19P	328
	XL 500	1984-				
	XR 500	1984-				
	CAMINO S 50	-19-			NE-8	329
	CBX 900 FII	-19-				
	CB 125 S	1979-	HOND-4D	327	NE-6	329
			HOND-4DP	327	NE-6P	329
			HOND-4I	327		
			HOND-4IP	327		
	CB 125 SI.	1982-	HOND-4I	327	NE-6	329
			HOND-4D	327	HOND-4D	327



FOR: PARA:	MODEL MODELO			PAG.		PAG.
<b>HONDA</b> ®	XL 125	1982-1983	HOND-4IP	327	NE-6P	329
					NE-8	329
			HOND-4DP	327	HOND-4DP	327
			HOND-4DP2	327	HOND-4DP2	327
	CB 125 T	1986-	HOND-4I	327	HOND-4I	327
	MTX 125 R	1986-	HOND-4IP	327	HOND-4IP	327
	SPACY SCOOT.	-19-				
	CB 125 T2	1982-	SUZU-13P	329	NE-6	329
			SUZU-4I	329	NE-6P	329
			SUZU-4IP	329		
			FAR-1D	327		
	CB 125 X	1982-	HOND-4I	327	NE-6	329
			FAR-1D	327		
	CBX 125	1982-1983	HOND-4IP	327	NE-6P	329
	CB 250 N	1986-	HOND-4D	327	NE-8	329
	CB 250 RS	1986-	HOND-4DP	327		
	CB 750 K	1979-1980				
	CB 400 L	1985-	HOND-4D	327	HOND-4D	327



Motocicleta  
Motozikleta  
Motos

Motorrad  
Motociclos  
Motocykli

FOR: PARA:	MODEL MODELO			PAG.		PAG.
<b>HONDA</b> ®						
		HOND-4IP1	327	HOND-4IP1	327	
CB 500S	1997-	HOND-24P	328	HOND-24P	328	
CBF 500	2004-2007					
CBF 600	2004-2007					
CBR 900 RR	1997-					
CBR 1000 F	1997-					
FORZA	2005-					
NTV 650	1997-					
NTV 650	1997-1998					
NX 650	1997-					
SFX 50	1997-					
SH 50	1997-					
SH 100	1997-					
SJ 100 BALI	1997-					
ST 1100	1997-					
CB 550 F	1979-1982			NE-6	329	
				NE-6P	329	
CB 650	-19-	HOND-4D	327			
		HOND-4DP	327			
CB 650 CUST	-19-	HOND-4D	327	NE-8	329	
CB 650 SC	-19-	HOND-4DP1	327			
		HOND-4DP2	327			
CB 750	1986-	HOND-4DP2	327	HOND-4DP2	327	
CX 500	1979-					
CB 750	1986-1991	HOND-19	328	HOND-19	328	
		HOND-19D	328	HOND-19D	328	
		HOND-19DP	328	HOND-19DP	328	
		HOND-19P	328	HOND-19P	328	
		HOND-4D	327	HOND-4D	327	
		HOND-4DP	327	HOND-4DP	327	
		HOND-4I	327	HOND-4I	327	
		HOND-4IP	327	HOND-4IP	327	
CB 750	1992-	HOND-4D	327	HOND-4D	327	
		HOND-4DP1	327	HOND-4DP1	327	
CB 750 F	1979-	HOND-7D	327	NE-6	329	
		HOND-7I	327	NE-6P	329	
CB 750 FO.	1978-	HOND-7I	327			
CB 1000	1993-	HOND-4D	327	HOND-4D	327	
CBR 900 RR	1994-1996	HOND-4DP1	327	HOND-4DP1	327	
		HOND-4DP2	327	HOND-4DP2	327	
		HOND-4I	327	HOND-4I	327	
		HOND-4IP1	327	HOND-4IP1	327	
CBR 1000	1992-	HOND-19	328	HOND-19	328	
		HOND-19D	328	HOND-19D	328	
		HOND-19DP	328	HOND-19DP	328	
		HOND-19P	328	HOND-19P	328	
		HOND-4D	327	HOND-4D	327	
		HOND-4DP1	327	HOND-4DP1	327	
		HOND-4DP2	327	HOND-4DP2	327	
		HOND-4I	327	HOND-4I	327	
		HOND-4IP1	327	HOND-4IP1	327	
CBX 125	1982-	HOND-4DP2	327	HOND-4DP2	327	
CBX 125	1983-1984	SUZU-13P	329	NE-6	329	
		FAR-ID	327	FAR-ID	327	
MH 125	1983-	SUZU-4I	329	NE-6P	329	
		FAR-II	327	FAR-II	327	
XL 125	1983-1984	SUZU-4IP	329	NE-8	329	

FOR: PARA:	MODEL MODELO			PAG.		PAG.
<b>HONDA</b> ®						
		HOND-4D	327	HOND-4D	327	
		HOND-4DP	327	HOND-4DP	327	
		FAR-ID	327			
		FAR-II	327			
CBX 900	1984-	HOND-19	328			
		HOND-19D	328			
		HOND-19DP	328			
		HOND-19P	328			
CBX 1000 S.S	-19-	HOND-4D	327	HOND-4D	327	
NTV 650	1984-1992	HOND-4DP	327	HOND-4DP	327	
ST 1100	-1991	HOND-4DP2	327	HOND-4DP2	327	
VF 400 F	1986-	HOND-4I	327	HOND-4I	327	
VFR 400 R	1986-	HOND-4IP	327	HOND-4IP	327	
XL 600	-1984					
CDI 125 6	1984-1986	HOND-4D	327	NE-8	329	
		HOND-4DP	327			
		HOND-4DP2	327			
CG 125	1993-	HOND-26DP1	328	HOND-26DP1	328	
CG 125	1993-2008	HOND-26P1	328	HOND-26P1	328	
ECONO POW.90	1993-					
CG 150	-19-	HOND-44DP		HOND-44DP		
		HOND-44P		HOND-44P		
CMX 450 SC.	-1991	SUZU-13P	329	SUZU-13P	329	
		SUZU-4I	329	SUZU-4I	329	
		SUZU-4IP	329	SUZU-4IP	329	
CN 250	-1991	HOND-4I	327	HOND-4I	327	
XL 250 R	-1991	HOND-4IP	327	HOND-4IP	327	
CN 250	1991-1994	HOND-19	328	HOND-19	328	
XL 250	-1991	HOND-19D	328	HOND-19D	328	
		HOND-19DP	328	HOND-19DP	328	
		HOND-19P	328	HOND-19P	328	
CR 250	-1991	HOND-19	328	HOND-19	328	
		HOND-19D	328	HOND-19D	328	
		HOND-19DP	328	HOND-19DP	328	
		HOND-19P	328	HOND-19P	328	
		HOND-4I	327	HOND-4I	327	
		HOND-4IP	327	HOND-4IP	327	
CRM 125	1990-	HOND-4D	327	HOND-4D	327	
NSR 125 F	1990-	HOND-4DP1	327	HOND-4DP1	327	
NSR 125 R	1990-	HOND-4DP2	327	HOND-4DP2	327	
NSR 125 R SP	1990-	HOND-4I	327	HOND-4I	327	
		HOND-4IP1	327	HOND-4IP1	327	
CRM 125	1990-1992	HOND-19	328	HOND-19	328	
MTX 200	-1989	HOND-19D	328	HOND-19D	328	
PK 50 DX WA.	1992-	HOND-19DP	328	HOND-19DP	328	
SA 50 M VIS.	1992-	HOND-19P	328	HOND-19P	328	
TRX 200	-1989					
XL 125	1990-					
XL 200	1990-1991					
CS 125	1982-	HOND-4DP2	327	HOND-4DP2	327	
		HOND-4I	327	NE-6	329	
		HOND-4IP	327	NE-6P	329	
		FAR-ID	327	FAR-ID	327	
CX 500	1979-1981	HOND-4D	327			
		HOND-4DP	327			
CX 500	1984-	HOND-4D	327	HOND-4D	327	
		HOND-4DP	327	HOND-4DP	327	

FOR: PARA:	MODEL MODELO			PAG.		PAG.
<b>HONDA</b> ®						
		HOND-4I	327	HOND-4I	327	
		HOND-4IP	327	HOND-4IP	327	
CX 500	1984-1987	HOND-19	328	HOND-19	328	
NTV 650	1984-1994	HOND-19D	328	HOND-19D	328	
NX 650	1991-1994	HOND-19DP	328	HOND-19DP	328	
ST 1100	1992-	HOND-19P	328	HOND-19P	328	
VF 400	1986-					
VFR 400	1986-					
VFR 750	1991-					
XL 600	1984-1985					
DYLAN 125	2004-	ZA-9P1	329	ZA-9P1	329	
PHANTEON 150	2003-					
PS 125I	2006-					
PS 150I	2006-					
SH 125I	2005-					
SH 150I	2006-					
GR	-19-	HOND-18DP	327	HOND-18DP	327	
GRX	-19-					
HORNET	1998-	HOND-43	328	HOND-43	328	
		HOND-43D	328	HOND-43D	328	
		HOND-43DP	328	HOND-43DP	328	
		HOND-43P	328	HOND-43P	328	
LEAD 100	2003-	HOND-28P	328			
MTX 125	1990-1992	HOND-19	328	HOND-19	328	
MX 125	1990-1992	HOND-19D	328	HOND-19D	328	
		HOND-19DP	328	HOND-19DP	328	
		HOND-19P	328	HOND-19P	328	
		HOND-4D	327	HOND-4D	327	
		HOND-4DP1	327	HOND-4DP1	327	
		HOND-4DP2	327	HOND-4DP2	327	
		HOND-4I	327	HOND-4I	327	
		HOND-4IP1	327	HOND-4IP1	327	
MTX 200 R	-1989	HOND-4D	327	HOND-4D	327	
TRX 200 SX	-1989	HOND-4DP	327	HOND-4DP	327	
XL 200	-1989	HOND-4DP2	327	HOND-4DP2	327	
XL 200 PD	-1989	HOND-4I	327	HOND-4I	327	
		HOND-4IP	327	HOND-4IP	327	
NAVI 110	2016-	HOND-36DP		HOND-36DP		
NH 50	-1991	AF-6D	327	NE-8	329	
PA 50 DLX	-1991					
PK 50 DX	-1991					
PX 50 S	-1991					
SA 50	-1991					
NX 125	1990-	HOND-4I	327	HOND-4I	327	
		HOND-4IP	327	HOND-4IP	327	
NXR 650 A.	1988-1990	HOND-4I	327	HOND-4I	327	
PC 800	1989-1991	HOND-4IP	327	HOND-4IP	327	
PK 50	1993-	HOND-25P2	327	HOND-25P2	327	
SA 50 P	1993-	HOND-4I	327	HOND-4I	327	
SH 50	1993-1996	HOND-4IP1	327	HOND-4IP1	327	
SFX 50	1994-1995	HOND-20	328			
SJ 50 BALI	1994-1995	HOND-20D	328			
		HOND-20DP	328			
		HOND-20P	328			
SH 50	1991-1993	VO-VBP1	329	HOND-30DP2	327	
				VO-VBP1	329	

FOR: PARA:	MODEL MODELO			PAG.		PAG.
<b>HONDA</b> ®						
					SUZU-13DP	329
					SUZU-4D	329
					SUZU-4DP	329
VARIOUS MODELS	-	HOND-18P		HOND-18P		
		HOND-23		HOND-23		
		HOND-24DP		HOND-24DP		
		HOND-27D		HOND-27D		
		HOND-29DP		HOND-29DP		
		HOND-29P	</			



Motocicleta  
Motozikleta  
Motos

Motorrad  
Motociclos  
Motocykli

FOR: PARA:	MODEL MODELO			PAG.		PAG.
KAWASAKI ©	EN 500	2000-2009				
	KLX 650	-19-				
	TWIN CAM	1992-				
	VN 1500	2002-2003				
	VN 1600	2003-2008				
	ZXR 400	1991-1994				
	ZXR 1100	1991-1992				
	ZZR 250	-19-				
	ZZR 600	-19-				
	ZZR 1100	1991-1992				
	550 LTD	1982-	KAW-3	330	KAW-3	330
	GPZ 250	-19-				
	GPZ 305	-19-				
	GPZ 450	-19-				
	GPZ 550	1982-1984				
	GPZ 600 R	-19-				
	GPZ 750	-19-				
	GPZ 750 R	-19-				
	GPZ 900 R	-19-				
	GPZ 1000	-19-				
	GPZ 1100	-19-				
	GPZ 1300	-19-				
	KL 250	-19-				
	KLR 250	-19-				
	VOYAGER	-19-				
	Z 250 C	-19-				
	Z 250 GP	-19-				
	Z 250 LTD	-19-				
	Z 305	-19-				
	Z 450	-19-				
	Z 550	1982-1984				
	Z 600	-19-				
	Z 750	-19-				
	Z 750 LTD	-19-				
	Z 750 TURBO	-19-				
	Z 900	-19-				
	Z 1000	-19-				
	Z 1100	-19-				
	Z 1300	-19-				
	900 Z1	-19-	KAW-4	330	KAW-4	330
	1000 GTR	1984-1991	KAW-3	330	KAW-5	330
	1300 Z	1986-1991	KAW-5	330	KAW-5P	330
	CS 250	1984-1986	KAW-5P	330		
	FX 400 R	1984-				
	GPZ 305	1984-				
	GPZ 550	1984-1990				
	GPZ 750	1984-1991				
	GPZ 900 R	-1986				
	GPZ 1000	1984-1991				
	GPZ 1100	1984-				
	GT 750	1984-1991				
	GTR 1000	1984-1991				
	KL 250	1984-1986				
	KLR 570	1984-1990				
	KLR 650	1980-1991				
	LTD 450	1984-				
	SR 650	1980-1991				

FOR: PARA:	MODEL MODELO			PAG.		PAG.
KAWASAKI ©	TENGAI 650	1980-1991				
	VN 750 T.	1984-1991				
	Z 250	1984-				
	Z 305 B.	1984-				
	Z 400	1984-				
	Z 440	1984-				
	Z 550	1984-1990				
	Z 750	1985-1992				
	Z 1000 RZ	1984-1991				
	Z 1100	1984-				
	Z 1300	1986-1991				
	ZN 1300 V	1986-1991				
	ZR 550	1984-1990				
	ZX 550	1984-1990				
	ZX 1000	1984-1991				
	ZXR 750	1985-1992				
	AR 125	-1986		NE-6		330
	KDX 175	-19-		NE-6P		330
	KE 125	-1986				
	KE 175	-19-				
	KMX 125	-1986				
	KX 125	-1986				
	BN 125 ELIM.	2006-2007	KAW-6P	330	KAW-6P	330
	VN 1700	2009-				
	VN 2000	2004-2010				
	EJ 650	1999-2006		KAW-9P		330
	EJ 800	2011-				
	Z 1000	2003-2005				
	ZRX 1100	1999-2000				
	ZRX 1200	2001-2006				
	EN 500	-1991	KAW-2I	329	KAW-2I	329
	ER 5	2003-	KAW-9P	330	KAW-9P	330
	ER 6	2006-2011				
	NINJA ZX- 6R	2003-2006				
	NINJA ZX- 7R	2003-				
	NINJA ZX- 9R	2003-2005				
	NINJA ZX-12R	2003-				
	ZR 7	1999-2005				
	ZZR 1200	2000-2005				
	EX250	1988-2009	KAW-9		KAW-9	
	GPZ500	1988-2009				
	GPZ550	1995-1998				
	GPZ750	1995-1998				
	KZ POLICE	1982-2005				
	KZ1000J	1982-				
	NINJA 750	1979-1992				
	NINJA ZX14	-2006				
	Z750S	-1999				
	ZRX11000	1999-2000				
	ZRX1200R	2001-2008				
	EX250	2008-	KAW-10DP		KAW-10DP	
	NINJA 250R	2008-	KAW-10P	330	KAW-10P	330
	GLX 1100	1993-	KAW-5	330	KAW-5	330
	GPX 600	1986-1990	KAW-5P	330	KAW-5P	330
	GPZ 500	1987-				
	GPZ 600	1986-1990				
	KDX 250 D	-19-				

FOR: PARA:	MODEL MODELO			PAG.		PAG.
KAWASAKI ©	KL 250	1986-				
	KLR 250	1986-1996				
	KX 250	1986-				
	LTD 450 C.	1986-				
	Z 650	1983-				
	ZL 600	1990-1992				
	ZZR 600	1990-1992				
	GPZ 400	-19-	KAW-3	330	KAW-3	330
	GPZ 550	-19-	KAW-4	330	KAW-4	330
	LTD 450	-19-	SUZU-13P	330		
	Z 400	-19-	SUZU-4I	330		
	Z 400 TW.	-19-	SUZU-4IP	330		
	Z 440 LTD	-19-				
	Z 550 LTD	-19-				
	GPZ 500 S	1994-	KAW-5P	330	KAW-5P	330
	KLE 500	1994-				
	GPZ 500 S	1994-2009	KAW-5	330	KAW-5	330
	KLE 500	1991-2007				
	GPZ 750	-1984	KAW-3	330		
	Z 400 F	1981-1982				
	Z 400 J	1981-1982				
	Z 750	1984-1985				
	KH 400	1978-	KAW-4	330	SUZU-13DP	330
	OH 400	1978-	SUZU-13DP	330		
	Z 400	1978-1981	SUZU-13P	330		
			SUZU-4D	330		
			SUZU-4DP	330		
			SUZU-4I	330		
			SUZU-4IP	330		
	KL 600 S	1986-1991	KAW-2D	329	KAW-2D	329
	KLR 600	1986-1991	KAW-2I	329	KAW-2I	329
	KLR 250	1985-1986	KAW-2I	329	KAW-2I	329
	KLR 250	1997-2010	KAW-7P	330		
	KLX 125	2010-2011				
	KLX 250	2008-2009				
	NINJA 500R	1993-1994				
	NINJA ZX- 6R	1993-2006				
	KLR 600	-19-	KAW-1D	329	KAW-1D	329
	Z 440	-19-	KAW-1I	329	KAW-1I	329
	Z 650 F	1984-1991				
	Z 650 S	1984-1991				
	Z 650 SR	1984-1991				
	KLR 600 S	1994-1999	KAW-7P	330	KAW-7P	330
	KLR 650	1994-1999				
	NINJA ZX- 9R	1994-2003				
	ZXR 750	1993-1994				
	ZZR 600	1994-2004				
	ZZR 1100	1993-1994				
	KLV 1000	2004-	SUZU-12DP	330	SUZU-12DP	330
	KLX250	2009-	KAW-7		KAW-7	
	NINJA ZX- 6R(ZX600F/G/J)	1995-2002				
	NINJA ZX-7,ZX-7R,ZX-7RR(ZX750)	1993-2003				
	SUPER SHERPA KL250G	2000-2003				
	VULCAN 1500 CLASSIC	2001-2005				

FOR: PARA:	MODEL MODELO			PAG.		PAG.
KAWASAKI ©	VULCAN 1500 CLASSIC	2005-2008				
	VULCAN 1500 DRIFTER	2001-2005				
	VULCAN 1500 NOMAD	2001-2005				
	ZX-6(ZX600D)(ZX600E)	1993-2002				
	ZX-9R(ZX900B/C/E/F)	1994-2003				
	ZZR600(ZX600E,ZX600J)	2003-2008				
	LDT 500	1995-	KAW-6DP	330	KAW-6DP	330
	VN 800	1995-2005				
	NINJA 250R	1990-2007	KAW-5	330		
	NINJA 600R	1990-1996	KAW-5P	330		
	NINJA ZX-11R	1993-2001				
	Z 500	1991-1998				
	Z 750	1992-1997				
	ZG 1000 CON.	1992-2006				
	ZRX 1100	1992-2000				
	SJ 50 BALI	1994-	KAW-5	330	KAW-5	330
			KAW-5P	330	KAW-5P	330
	VN 250	2000-	KAW-6DP	330	KAW-6DP	330
	VN 400	1999-2000				
	VN 1500	1987-2001				
	Z 250 A	1982-	KAW-2I	329		
	Z 250 C	1982-	KAW-8D	330		
	Z 250 J	1982-				
	Z 400	1981-1984	KAW-2I	329		
	Z 440 H	1982-	KAW-2D	329		
	Z 440 J	1982-	KAW-2I	329		
	Z 440 LTD	1982-				
	Z 500	1981-1991	KAW-3	330		
	Z 750	1998-2005	KAW-9P	330	KAW-9P	330
	ZL 600 ELI.	1997-	KAW-5	330		
			KAW-5P	330		
	ZXR 400	1990-1991	KAW-2D	329	KAW-2D	329
	ZXR 1100	1990-1991				
	ZZR 1100	1990-1991				
KTM ©	125 DUKE	2012-	KM-1P	331		
	RC 390	2015-				
	ER 5	2003-	ZA-9P1	331	ZA-9P1	331
	MODELOS	1988-	VO-VBP1	331	VO-VBP1	331
KYMCO ©	XCITING 250	2005-	KYM-3DP	331	KYM-3DP	331
	XCITING 300	2008-2009	KYM-3P	331	KYM-3P	331
	XCITING 500	2005-2009				
	AGILITY	2005-	KYM-IDP	331		
			KYM-1P	331		
	CX 50	1997-	HOND-4I	331	HOND-4I	331
	K 1250	1997-	HOND-4IP	331	HOND-4IP	331
	KB 50	1997-				
	SNIPER 50 DD	1997-				
	GRANDINK	2001-	KYM-2P	331		
	HEROISM	1997-	KYM-IDP	331	KYM-IDP	331
			KYM-1P	331	KYM-1P	331
	VARIOUS MODELS	-	KYM-2		KYM-2	

Motocicleta  
Motozikleta  
Motos

Motorrad  
Motociclos  
Motocykli

FOR: PARA:	MODEL MODELO			PAG.		PAG.
---------------	-----------------	--	--	------	--	------

<b>KYMCO</b>				KYM-2D		KYM-2D
				KYM-2DP		KYM-2DP

<b>LAMBRETTA</b>	LUI 50	-19-			IMS-3	331
					IMS-3P	331
					NE-56	331

<b>LAVERDA</b>	50 ATLAS	1986-1990		ZA-1	332	ZA-1	332
	50 GAUCHO	1986-		ZA-1P	332	ZA-1P	332
	125 CU RIDE	1986-1990					
	125 FORMULA	1986-1990					
	125 LESMO G	1986-1990					
	600 ATLAS O	-19-					
	1000 SFC	1986-					
	50 LZ	-19-		NE-8	332	NE-8	332
	125 GS LES.	1984-		ZA-1	332	ZA-1	332
	125 L ELEG.	1984-		ZA-1P	332	ZA-1P	332
	125 LB CUS.	1984-					
	125 LB SAB.	1984-					
	125 LB UNO	1984-					
	125 LZ CUS.	1984-					
	350 LESMO	1984-					
	V6 1000 R	-19-					
	125 LZ	1978-		NE-6	331	NE-6	331
				NE-8	332	NE-8	332
				FAR-1D	331	FAR-1D	331
	125 LZ C.	1978-		NE-6P	332	NE-6P	332
				FAR-1I	331		
	125 LZ S.	1978-		NE-8	332		
	500 4T	-19-		SUZU-13P	332	NE-6	331
				FAR-1D	331		
	500 SFC	-19-		SUZU-4I	332	NE-6P	332
				FAR-1I	331		
	1000 JOTA	-19-		SUZU-4IP	332		
	1000 JOTA120	-19-					
	1000 RGS	-19-					
	1200 TS	1978-					
	1000	1978-		SUZU-13P	332	NE-6	331
	1200	1978-		SUZU-4I	332	NE-6P	332
	750	1978-		SUZU-4IP	332		
	PHOENIX	2003-		ZA-8P	332	ZA-8P	332

<b>LINCE</b>	125 SERVETTE	-19-		AF-5D	332	CL-2I	332
	150 SERVETTE	-19-				CL-3I	332
	200 SERVETTE	-19-					

<b>MAICO</b>	GM STAR 250E	-19-				CL-2I	332
	GM STAR 500E	-19-				CL-3I	332
	GM STAR SID.	-19-				NE-6	332
						NE-6P	332
						NE-8	333

<b>MALAGUTI</b>	50 MDX	1986-1991		ZA-1	333	ZA-1	333
	50 MEX	1986-1991		ZA-1P	333	ZA-1P	333
	50 MFX	1986-1991					
	50 MGX	1986-1991					
	CUSTOM	1986-1991					

FOR: PARA:	MODEL MODELO			PAG.		PAG.
---------------	-----------------	--	--	------	--	------

<b>MALAGUTI</b>	FIFTY FULL	1986-					
	FIFTY HF 50	1986-1991					
	FIFTY TOP 50	1986-					
	RUNNER YLC	1986-1991					
	TOP 50	1986-1991					
	125	1986-			ZA-1	333	
	125 RUNNER	1986-			ZA-1P	333	
	CAVALCONE 80	-19-					
	CHOPPER 25	-19-					
	CHOPPER 40	-19-					
	CHOPPER 80	-19-					
	DRIBBLING	1986-					
	DROP	-19-					
	DUNE ES	1986-					
	DUNE KS	1986-					
	FIFTY	-19-					
	FIRE BIRD	-19-					
	GRIZLY UNO	-19-					
	MRX ENDURO	1986-					
	NEW DRIBLING	-19-					
	PULL CX	-19-					
	CENTRO SL	1994-		ZA-4DP	333	ZA-4DP	333
	CROSSER 50	1994-					
	F 10	1994-					
	PHANTOM	1994-					
	F 10 JET	1992-		YAMA-27	333	YAMA-27	333
				YAMA-27D	333	YAMA-27D	333
				YAMA-27DP	333	YAMA-27DP	333
				YAMA-27P	333	YAMA-27P	333
				YAMA-30P	333	YAMA-30P	333
	FIREFOX F15	1996-1997		ZA-9P	333	ZA-9P	333
	MADISON	2003-		ZA-9P	333	ZA-9P	333
	RS	1991-		ZA-4DP	333	ZA-4DP	333
	RST 50	1991-1992		ZA-13P	333	ZA-4DP	333
				ZA-4DP	333		
	VARIOUS MODELS	1996-		ZA-9P2		ZA-9P2	

<b>MALANCA</b>	125 MARKT	-19-		ZA-1	333	ZA-1	333
				ZA-1P	333	ZA-1P	333
	BIG	-19-				ZA-1	333
	GTS 4 4M	-19-				ZA-1P	333
	GTS 5	-19-					
	LP	-19-					
	LPRL	-19-					

<b>MBK</b>	BOOSTER	1995-1997		ZA-4DP	333	ZA-4DP	333
	EVOLIS	1995-					
	FORTE	1995-					
	NEW SORRISO	1995-					
	BOOSTER	1998-		ZA-9P1	333	ZA-9P1	333
	KILIBRE	2003-					
	OVETTO	1998-					
	BOOSTER 50	-19-		YAMA-27	333	YAMA-27	333
	EVOLIS	-19-		YAMA-27D	333	YAMA-27D	333
	SCOOTER	-19-		YAMA-27DP	333	YAMA-27DP	333
	SORRISO	-19-		YAMA-27P	333	YAMA-27P	333
	TARGET	-19-		ZA-4DP	333	ZA-4DP	333

FOR: PARA:	MODEL MODELO			PAG.		PAG.
---------------	-----------------	--	--	------	--	------

<b>MBK</b>	VARIOUS MODELS	1997-2004		ZA-9P2		ZA-9P2
------------	----------------	-----------	--	--------	--	--------

<b>MBM</b>	BREEZE LUSSO	-19-			ZA-1	334
	BULL	-19-			ZA-1P	334
	CRAZY	-19-				
	PONY	-19-				
	SOGNO	-19-				

<b>MONTESA</b>	250 ENDURO	-1991			CL-2I	334
	250 KING SC.	-1991			CL-3I	334
	348 TRIAL	-1991				
	360 ENDURO	-1991				
	CAPRA 250	-1991				
	COTA 50	-1991				
	COTA 50 AR.	-1994				
	COTA 50 H20	-1994				
	COTA 123 C	-1991				
	COTA 125	-1991				
	COTA 200	-1991				
	COTA 242 T	-1991				
	COTA 247	-1991				
	COTA 250	-1991				
	COTA 304	-1991				
	COTA 307	-1991				
	COTA 330	-1991				
	COTA 335	-1991				
	COTA 348	-1991				
	COTA 349	-1991				
	COTA 350	-1991				

<b>MORINI FRANCO</b>	GIULIETTA O.	-19-			ZA-1	334
	LEM	-19-			ZA-1P	334

<b>MOTO GUZZI</b>	65 GT	1984-		IMS-5	334	NE-6	334
				ZA-1	335		
				ZA-1P	335		
	650 NTX	1984-		IMS-5P	334	NE-6P	334
	V 50	1990-				NE-8	334
	V 50 C	1984-					
	V 50 III	1990-					
	V 50 MONZA	1984-					
	V 65	1984-					
	V 65 C	1984-					
	V 65 FL.	1984-					
	V 65 II	1984-					
	V 65 LA.	1984-					
	V 65 SP	1984-					
	V 65 TT	1984-					
	V 75	1984-					
	125 BX	1986-				NE-8	334
	125 CUSTOM	1986-					
	125 TT	1986-					
	245	-19-					
	125 TURISMO	-19-				NE-6	334
	DINGO	-19-				NE-6P	334
	STORNELLO	-19-					

FOR: PARA:	MODEL MODELO			PAG.		PAG.
---------------	-----------------	--	--	------	--	------



<b>MOTO GUZZI</b>	125 TURISMO	1981-		IMS-5	334	NE-8	334
	V 35	1984-		IMS-5P	334		



	V 35 C	1984-1986					
	V 35 F.	1984-					
	V 35 II	1984-					
	V 35 III	1984-					
	V 35 IMOLA	1984-					
	250 ELECTR.	-19-		FEM-2D	334	NE-8	334
				FEM-2I	334		



	250 TS	-19-		FEM-2D	334	NE-6	334
				FEM-2I	334	NE-6P	334
	350 GTS	-19-		FEM-2D	334	NE-6	334
				FEM-2I	334	NE-6P	334
	350 NEVADA	1994-		ZA-1	335	ZA-1	335
	750 NEVADA	1994-		ZA-1P	335	ZA-1P	335
	750 NTX	1990-		ZA-1	335	NE-8	334
	V 75 NTX	1990-		ZA-1P	335		
	850 GT	1986-		FEM-ID	334	NE-6	334
				FEM-II	334	NE-6P	334



Motocicleta  
Motozikleta  
Motos

Motorrad  
Motociclos  
Motocykli

FOR: PARA:	MODEL MODELO			PAG.		PAG.
<b>MOTO GUZZI</b>	350	1979-	IMS-5	334	NE-6	334
	500	-19-	IMS-5P	334	NE-6P	334
	BREVA	2003-	ZA-9P1	335	ZA-9P1	335
	CALIFOR. EV	2003-				
	V 11	2003-				
	FAL.SAHARA	-19-	FEM-ID	334		
	SP 1000 II	1984-	IMS-5	334	NE-6	334
	V 1000 CALI.	1984-	IMS-5P	334	NE-6P	334
	V 1000 CONV.	1984-				
	V 1000 GT	1984-				
	V 1000 SP	1984-				
	V 1000 SP II	1984-				
	V 7 SPORT	-19-	SIP-3	334	NE-6	334
					NE-6P	334
	V 1000 C.	1979-	FEM-ID	334	NE-6	334
			FEM-1I	334	NE-6P	334
			SIP-3	334		
	V 1000 G5	1979-	IMS-5	334	IMS-5	334
			IMS-5P	334	IMS-5P	334
	V 1000 I LE.	1984-	IMS-5	334	NE-8	334
			ZA-1	335		
			ZA-1P	335		
	V 1000 IDRO.	1984-	IMS-5P	334		
	V 1000 II L.	1984-				
<b>MOTO MORINI</b>	3 1/2 SPO.	1981-	FEM-ID	335	NE-6	335
	3 1/2 V	1981-	FEM-1I	335	NE-6P	335
	125 T	1981-				
	250	1981-				
	250 BIC	1981-				
	500 GV	-19-				
	500 KANGEROO	-19-				
	500 T/S	-19-				
	50 CORSARIO	-19-			NE-6	335
	125 CORSARIO	-19-			NE-6P	335
	250 KANGURO	1979-				
	250 STRADA	1979-				
	550	1979-				
	125 H	1984-	FEM-2D	335	ZA-1	335
	125 KJ	1984-	FEM-2I	335	ZA-1P	335
	350 COGUARO	1986-	AF-6D	335	ZA-1	335
	350 EXCALIB.	1986-			ZA-1P	335
	350 KANGURO	1986-				
	350 NEW YORK	1986-				
	350 XE	1986-				
	501 COGUARO	1986-				
	501 EXCALIB.	1986-				
	501 KANGURO	1986-				
	501 NEW YORK	1986-				
	500 CAMEL	-19-	AF-6D	335	NE-8	335
<b>MOTOBECANE</b>	125 LT	-19-	LAS-X	335	NE-6	335
	SUPERMOBY 51	-19-			NE-6P	335
<b>MOTOBI</b>	254	-19-	IMS-5	335	NE-8	336
			IMS-5P	335		

FOR: PARA:	MODEL MODELO			PAG.		PAG.
<b>MOTOMEL</b>	CGS2	2006-			MOT-1P	
	DAKAR 200	2006-			MOT-4P	
	HAWKER	2006-			MOT-2P	
	SKORPION	2006-			MOT-3P	
<b>MOTRON</b>	3/TRE-RCV	-19-			ZA-1	336
	MST	-19-			ZA-1P	336
	RA PL 4P	-19-				
	SU 3R ID	-19-				
	TAXI AP	-19-				
	TAXI ES 1D	-19-				
	COMPACT	1990-1991	ZA-1	336	ZA-1	336
	GL 4	1990-1991	ZA-1P	336	ZA-1P	336
	GTO	1990-1991				
	INVADER	1990-1991				
	SHOPPING	1990-1991				
	TAXI ES ID	1990-1991				
	TAXI KS SL	1990-1991				
<b>MV AUGUSTA</b>	125 S	-19-	FEM-1I	336		
	125 SPORT	-19-			FEM-1I	336
	350 SPORT	-19-			FEM-2I	336
	350 S	-19-	AF-7I	336	AF-7I	336
			AF-7IP	336	AF-7IP	336
	750 S	-19-	SUZU-13P	336	NE-6	336
			SUZU-4I	336	NE-6P	336
			SUZU-4IP	336		
			FAR-ID	336		
			FAR-1I	336		
<b>MZ</b>	TOUR	1994-	ZA-4DP	336		
<b>NORTON</b>	850 COMMANDO	-19-	UN-3	337		
			UN-FS	337		
<b>OMC</b>	CITY	-19-			ZA-1	337
	ELITE	-19-			ZA-1P	337
	ELITE SL	-19-				
	ELS-SL	-19-				
	EXCLAIM	-19-				
	HI TECH	-19-				
	MARINER-SL	-19-				
	MUDDY	-19-				
	MUDDY JUNIOR	-19-				
	WILD ELITE	-19-				
	WILD MS	-19-				
	WILD TIGRE	-19-				
<b>OSSA</b>	125	-19-	CAS-ID	337	NE-6	337
	250 ENDURO	-19-			NE-6P	337
	350 ENDURO	-19-				
	250 DESERT	-19-			CL-2I	337
	250 EXPLORER	-19-			CL-3I	337
	250 FUEGO	-19-				
	250 ORANGE	-19-				
	250 SUPER	-19-				
	250 TRIAL	-19-				

FOR: PARA:	MODEL MODELO			PAG.		PAG.
<b>OSSA</b>	250 TU	-19-				
	250 TURISMO	-19-				
	250 YO	-19-				
	350 EXPLORER	-19-				
	350 ORANGE	-19-				
	350 TRIAL	-19-				
	TRIAL 303	-19-				
	TRIAL JELLOW	-19-				
<b>PERIPOLI</b>	COLORADO	-19-			ZA-1	337
	DAY LXR/SA	-19-			ZA-1P	337
	DAY S 5/K	-19-				
	GIULIETTA	-19-				
	MINI L SAMIK	-19-				
	OXFORD	-19-				
	OXFORD ROAD	-19-				
	TIR	-19-				
	VAI MO3	-19-				
	VAI R	-19-				
	WILD	-19-				
<b>PEUGEOT</b>	BUXY	1994-1997	ZA-1	338	ZA-1	338
	FOR LUX	1994-1998	ZA-12	338	ZA-12	338
	SPEEDAKE	1995-1997				
	SQUAB	1995-1996				
	LOOXOR	2001-			NE-45	337
	LUDIX	2004-			NE-45P	337
	SPEEDFIGHT	1997-				
	SV GEO	1991-1995				
	TREKKER	1998-				
	VIVACITY	1999-				
	X-RACE	2003-				
	SC 50 L SCO.	-19-	SUZU-13P	338	SUZU-13P	338
	SC 80 L SCO.	-19-	SUZU-4I	337	SUZU-4I	337
	ST 50 L SCO.	-19-	SUZU-4IP	338	SUZU-4IP	338
	SV 125 SCO.	-19-				
	SQUAB	1997-	NE-45P	337		
	SV 50 GEO	1992-	NE-45	337	NE-45	337
	SV 80 GEO	1993-	NE-45P	337	NE-45P	337
	SV 125 GEO	1993-				
	ZENITH	1994-1996	ZA-12	338	ZA-12	338
<b>PGO</b>	COMET	2000-	PGO-2P	338		
	PMS	2000-				
	PMX	2000-				
	RODOSHOW	2000-				
	TREX	2000-				
	SCOOTER	-19-	PGO-1	338		
<b>PIAGGIO</b>	APE 600 MP	1979-1981			AF-6D	338
	APE CAR	-19-	AF-9D	338	FAB-1	338
	APE CAR P3	-19-	AF-9DP	338		
	APE CARP 601	-19-	AF-9I	338		
			AF-9IP	338		
			FEM-ID	338		
			FEM-1I	338		
	APE P 50	-19-	FEM-ID	338	NE-6	339

FOR: PARA:	MODEL MODELO			PAG.		PAG.
<b>PIAGGIO</b>	APE TM P 50	-19-	FEM-1I	338	NE-6P	339
					ZA-1	339
					ZA-1P	339
	APE TM 703	-19-	AF-9D	338	FAB-1	338
			AF-9DP	338		
			AF-9I	338		
			AF-9IP	338		
	BOSS 50	1986-			ZA-1	339
	BRAVO 50	1986-			ZA-1P	339
					ZA-2P	339
	CIAO 50	1986-				
	GRILLO 50	1986-				
	SI 50	1986-				
	BOXER 50	1982-1986			NE-8	339
	BRAVO 50	1982-1986			ZA-1	339
	CIAO 50	1982-1986			ZA-1P	339
	SI 50	1982-1986				
	BRAVO	1992-			ZA-1	339
					ZA-1P	339
	CARNABY	2007-			FI-13P1	338
	FLY	2005-2012				
	SKIPPER	1999-2000				
	VESPA	1996-				
	ZIP	2000-2011				
	CIAO	1992-			ZA-1	339
	GRILLO	1992-			ZA-1P	339
	SI	1992-				
	COSA 125	1988-	ZA-2P	339	ZA-2P	339
	COSA 150	1988-				
	COSA 200	1988-				
	VESPA 50 PK	1986-				
	VESPA FL 2	1986-				
	VESPA PLURI.	1986-				
	VESPA RUSH	1986-				
	COSA 125 MA	1992-	FI-1	338	FI-1	338
	COSA 150 MA	1992-	FI-1P	338	FI-1P	338
	COSA 2 125	1993-	ZA-2P	339	ZA-2P	339
	COSA 2 150	1993-				
	COSA 2 200	1993-				
	COSA 200 MA	1992-				
	VESPA 125 E	1984-				
	VESPA P 125</					

Motocicleta  
Motozikleta  
Motos

Motorrad  
Motociclos  
Motocykli

FOR: PARA:	MODEL MODELO			PAG.		PAG.
<b>PIAGGIO</b>	QUARTZ	1992-	ZA-2P	339	ZA-2P	339
	VESPA 50	1992-	ZA-7DP	339	ZA-7DP	339
	ZIP	1992-1993				
	SCATTO	-1991	ZA-13P	339	ZA-13P	339
	SFERA	1992-	ZA-2P	339	ZA-2P	339
	SFERA	1995-1998	ZA-7DP	339	ZA-7DP	339
	TOLEDO-SC	-19-			CL-2I	338
					CL-3I	338
	VARIOUS MODELS	-	ZA-7DP1		ZA-7DP1	
	VARIOUS MODELS	2006-2011	ZA-9P2		ZA-9P2	
	VESPA 50	1979-1983	FEM-1D	338	NE-6	339
			AF-5D	338		
			ZA-1	339		
			ZA-1P	339		
	VESPA 50 ES	1981-1983	FEM-1I	338	NE-6P	339
	VESPA 125 E	1981-1984			NE-6	339
	VESPA P 125X	1981-			NE-6P	339
	VESPA P 150X	1981-				
	VESPA P 200X	1981-				
	VESPA PX125E	1981-				
	VESPA 125 ET	1979-	FEM-1D	338	ZA-1	339
	VESPA 200 PX	1979-	FEM-1I	338	ZA-1P	339
	VESPA P 150X	1979-1981				
	VESPA 125ET3	-1979	FEM-1I	338	NE-6	339
					NE-6P	339
	VESPA 150	1979-			NE-6	339
	VESPA 150 RA	1979-			NE-6P	339
	VESPA 150 SV	1979-				
	VESPA P 80X	-19-			NE-6	339
					NE-6P	339
	VESPA P 125	-19-	FI-1	338	FI-1	338
	VESPA PK 125	-19-	FI-1P	338	FI-1P	338
			ZA-2P	339	ZA-2P	339
	VESPA PK 50	1984-1986	FI-1	338	FI-1	338
	VESPA PK 50S	1984-1986	FI-1P	338	FI-1P	338
	VESPA PX 200	1986-			NE-6	339
					NE-6P	339
<b>RALEIGH</b>	CICLI	-19-			LF-2	339
	CYCLES	-19-			UN-FP	339
<b>RIZZATO</b>	ATALA	1995-	ZA-4DP	339		
	HACKET AT12	1995-				
	HACKET RACI.	1995-				
<b>SULKI</b>	125	1992-	BH-4	340	BH-4	340
			ZA-1	340		
			ZA-1P	340		
	50	-1992				
<b>SUZUKI</b>	400 ENDURO	1978-	SUZU-13P	340		
	400 S	1978-	SUZU-4I	340		
	GT 350	1978-	SUZU-4IP	340		
	650 DJEBEL	-1991	SUZU-13P	340	SUZU-13P	340
	DR 125 S	-19-	SUZU-4I	340	SUZU-4I	340
	DR 400	1980-1985	SUZU-4IP	340	SUZU-4IP	340

FOR: PARA:	MODEL MODELO			PAG.		PAG.
<b>SUZUKI</b>	DR 600	1985-				
	RGT 125	-19-				
	TS 125 S	-19-				
	TS 125 X	-19-				
	ADDRESS	1992-	SUZU-11D	340	SUZU-11D	340
	DR 350 SE	1994-	SUZU-11DP	340	SUZU-11DP	340
	ADDRESS 100	1994-	SUZU-11D	340	SUZU-11D	340
	DR 650	1992-	SUZU-11DP	340	SUZU-11DP	340
	GS 400	1993-				
	GS 500	1989-				
	GS 750	1991-				
	GSF 400	1993-				
	GSF 500 EP	1993-				
	GSF 600	1995-				
	GSX 600	1989-1997				
	GSX 750	1988-				
	GSX 1100 92	1992-				
	GSXR 750	1989-1996				
	GSXR 1100	1990-				
	RF 600 R	1993-				
	RF 900 R	1994-				
	RG 125	1995-				
	RS 650	1991-				
	RV 750	1989-				
	VS 800	1992-				
	VS 1400	1990-				
	VX 800	1990-				
	AH 50	1991-	YAMA-20I	341	YAMA-20I	341
	CP 50	1991-	YAMA-24IP	341	YAMA-24IP	341
			YAMA-28P	341	YAMA-28P	341
	AJ 50 ZZ	1995-	ZA-4DP	341	ZA-4DP	341
	AP 50	1995-				
	AN 125	1995-	YAMA-23DP	341	NE-8	340
	VS 600 GL	1995-	YAMA-23IP	341		
	VS 800 GL	1995-				
	CC 1	-19-	SUZU-13P	340	NE-8	340
	RV 90	-19-	SUZU-4I	340		
			SUZU-4IP	340		
	DL 1000	2003-	SUZU-12DP	340	SUZU-12DP	340
	GSXR 1000	2003-				
	SV 650 S	2003-				
	SV 1000 S	2003-				
	DR 125 SE	1995-	YAMA-20D	341	NE-8	340
	LS 650	1995-	YAMA-20I	341		
	VS 1400 GLP	1995-	YAMA-20IP	341		
	DR 250 S	1984-	SUZU-13P	340	SUZU-13P	340
	DR 500	1984-1986	SUZU-4I	340	SUZU-4I	340
	DR 650	1990-1991	SUZU-4IP	340	SUZU-4IP	340
	DR 750 BIG	1988-1991				
	DR 800 SL	1990-				
	GS 125 ES	1984-				
	GS 550	1984-1985				
	GS 850	1980-1982				
	DR 350	1997-	YAMA-20I	341		
	DR 350 S	1993-	YAMA-20D	341	NE-8	340
	DR 350 SM	1992-	YAMA-20I	341		
	DR 350 SN	1992-	YAMA-24DP	341		



FOR: PARA:	MODEL MODELO			PAG.		PAG.
<b>SUZUKI</b>	VS 750 J.	-19-	YAMA-24IP	341		
			YAMA-28P	341		
	DR 650 RSE	1995-	SUZU-12DP	340	SUZU-12DP	340
	GS 500 E	1995-				
	GSF 600	1995-				
	GSXR 750 SP	1995-				
	GSXR 750 W	1995-				
	GSXR 1100	1995-				
	G 450 L	1980-	SUZU-5	340	SUZU-5	340
	GN 400	1985-	SUZU-5P	340	SUZU-5P	340
	GNX 250	1985-1991				
	GR 650	1982-				
	GS 450	1980-				
	GS 500	1984-1989				
	GS 550	1982-1984				
	GS 750	1982-1987				
	GS 850	1982-1985				
	GSX 250 S	1985-1991				
	GSX 400	1985-				
	GSX 500	1989-				
	GSX 550	1985-				
	GSXR 1100	1981-				
	LS 650	1982-				
	LT 250 A	1985-1991				
	RG 250 R	1985-1991				
	RGV 250	1985-1991				
	GS 400 T	-19-	SUZU-13P	340		
	GT 500	1978-	SUZU-4I	340		
			SUZU-4IP	340		
	GS 500 F	2004-	SUZU-12DP	340	SUZU-12DP	340
	GSF BANDIT	2004-				
	GSX R1300	2004-				
	GZ 250	2004-				
	LR GSX 600	2004-				
	SV 650	2004-				
	SV 750	2004-				
	VL 800	2004-				
	V-STROM 650	2004-				
	V-STROM 1000	2004-				
	VZ 1600	2004-				
	GS 1000	1982-1985	SUZU-13P	340	SUZU-13P	340
	GSX 1100	1981-1985	SUZU-4I	340	SUZU-4I	340
	RG 500	1985-	SUZU-4IP	340	SUZU-4IP	340
			SUZU-5	340	SUZU-5	340
			SUZU-5P	340	SUZU-5P	340
	GSX 600	1998-2006			SUZU-12D	
	GSX 1300 HA.	1999-2006			SUZU-12DP	340
	GSX 650	2008-				
	GSX 1200	1999-2000				
	GSX 1400	2002-2005				
	GZ 125	1998-				
	RV 125	2003-				
	XF 650	1997-2001				
	GSX 750	1981-1987	SUZU-13P	340	NE-8	340
			SUZU-4I	340	SUZU-13P	340
			SUZU-4IP	340	SUZU-4I	340
			SUZU-5	340	SUZU-4IP	340



FOR: PARA:	MODEL MODELO			PAG.		PAG.
<b>SUZUKI</b>			SUZU-5P	340	SUZU-5	340
					SUZU-5P	340
	GSX 750	1988-2006			SUZU-12D	
					SUZU-12DP	340
	GSXR 600	1997-	SUZU-12DP	340		
	GSXR 750	1997-				
	GT 550	1978-	SUZU-3I	340		
	GT 750	1978-				
	INTRUDE.1400	1993-	YAMA-19D	341	NE-8	340
	VS 800 GL	1993-1995	YAMA-19DP	341		
			YAMA-19I	341		
			YAMA-19IP	341		
			YAMA-23DP	341		
			YAMA-23IP	341		
			YAMA-29P	341		
	KATANA	1997-	ZA-4DP	341		
	KATANA R	2004-	ZA-9P1	341	ZA-9P1	341
	TL 1000	1997-2002			SUZU-12D	
	TU 125	1999-			SUZU-12DP	340
	TU 250	1997-2001				
	VARIOUS MODELS	-	SUZU-12P		SUZU-12P	
			SUZU-21P	340	SUZU-21P	340
			YAMA-20DP		YAMA-20DP	
	VS 750 INT.	1986-	YAMA-18D	341	YAMA-18D	341
			YAMA-18DP	341	YAMA-18DP	









Motocicleta  
Motozikleta  
Motos

Motorrad  
Motociclos  
Motocykli

FOR: PARA:	MODEL MODELO			PAG.		PAG.
<b>SWM</b> ®	WPM 1	-19-			NE-6	341
					NE-6P	341
<b>TESTI</b> ®	CRICHET PULL	-19-			NE-6	342
					NE-6P	342
<b>TRIUMPH</b> ®	AMERICA	2006-	TRP-1D	342		
	BONNEVILLE	2006-	ZA-9P1	342		
	DAYTONA	2006-				
	ROCKET III	2006-				
	SCRAMBLER	2006-				
	SPEEDMASTER	2006-				
	SPRINT ST	2006-				
	THRUXTON	2006-				
	TIGER	2006-2009				
	TRIDENT	-19-	UN-3	342	NE-6	342
					NE-6P	342
			UN-FS	342		
	VARIOUS MODELS	-	TRP-2		TRP-2	
<b>VARIOUS BRANDS</b>	VARIOUS MODELS	-	AS-19D	342	AS-19D	342
			BUR-6	342	BUR-6	342
			DAL-1P		DAL-1P	
			LAS-Y		TIT-7D	343
			TIT-7D	343		
<b>YAMAHA</b> ®	250 COMPETI.	-19-	YAMA-3I	343	YAMA-3I	343
	400	-19-	YAMA-14I	343	YAMA-14I	343
	RD 400	-19-	YAMA-15D	343	YAMA-15D	343
			YAMA-15I	343	YAMA-15I	343
	400 BICILIN.	-19-	YAMA-17D	343	YAMA-17D	343
			YAMA-17I	343	YAMA-17I	343
	500	1979-	YAMA-9I	343	YAMA-9I	343
	500 ENDURO	1979-	YAMA-14I	343	YAMA-14I	343
	RD 500	1979-				
	TT 350	1995-				
	600 ACERBIS	1980-	YAMA-14D	343	YAMA-14D	343
	OHC 650	1980-	YAMA-14I	343	YAMA-14I	343
	AEROX	1998-	ZA-9P1	345	ZA-9P1	345
	NEOS	1998-				
	VERSITY 300	2003-				
	AXIS	1995-	ZA-4DP	345	ZA-4DP	345
	BREEZE	1995-				
	SPY	1995-				
	BL 125 BE.	1984-1991	YAMA-18D	343	NE-8	343
			YAMA-21I	344	YAMA-21I	344
	DT 125 BA.	1984-1991	YAMA-18DP	344		
			YAMA-21IP	344	YAMA-21IP	344
	DT 125 BB.	1984-1991	YAMA-18I	343		
	DT 125 CF.	1984-1991	YAMA-18IP	344		
	DT 125 R	1984-1986	YAMA-19D	343		
	RD 350	1984-1991	YAMA-19DP	344		
	RT 125 LL	1984-1991	YAMA-19I	343		
	SCROW 225	1984-1991	YAMA-19IP	344		
	SR 250	1984-1991	YAMA-20D	343		
	TDR 125	1984-1991	YAMA-20I	343		

FOR: PARA:	MODEL MODELO			PAG.		PAG.
<b>YAMAHA</b> ®	TDR 250	1984-1991	YAMA-20IP	344		
	TZR 125	1984-1991	YAMA-22DP	344		
	TZR 250	1984-1991	YAMA-22IP	344		
	XS 350	1984-1991	YAMA-23DP	344		
	XT 600	1984-1991	YAMA-23IP	344		
	XT 600 4V.	1984-1991	YAMA-24DP	344		
	XT 600 TE.	1984-1991	YAMA-24IP	344		
	XT 600 Z-ZA	1984-1991	YAMA-28P	344		
	YZ 125 LC	1984-1991	YAMA-29P	344		
	YZ 250 LC	1984-1991				
	BL 125 BE.	1991-	YAMA-18D	343	NE-8	343
			YAMA-21I	344		
	DT 125 BA.	1991-	YAMA-18DP	344		
			YAMA-21IP	344		
	DT 125 BB.	1991-	YAMA-18I	343		
	DT 125 CF.	1991-	YAMA-18IP	344		
	DT 125 R	1991-1992	YAMA-19D	343		
	RD 350	1991-	YAMA-19DP	344		
	RD 350 LC	1991-	YAMA-19I	343		
	RT 125 LL.	1991-	YAMA-19IP	344		
	SCROW 225	1991-	YAMA-20D	343		
	SR 250	1991-	YAMA-20I	343		
	TDR 125	1991-1992	YAMA-20IP	344		
	TDR 250	1991-				
	TT 350	1991-1995				
	TZR 125 R	1991-1992				
	TZR 250	1991-				
	XT 600	1991-				
	XT 600 4V.	1991-				
	XT 600 TE.	1991-				
	XT 600 Z-ZA	1991-				
	YZ 125 LC	1991-				
	YZ 250 LC	1991-				
	BREEZE	1994-	ZA-4DP	345	ZA-4DP	345
	BT 1100 BU.	2003-2005	ZA-9P1	345	ZA-9P1	345
	CR 50 Z	1992-	YAMA-27	344	YAMA-27	344
	CT 50 S	1992-	YAMA-27P	344	YAMA-27P	344
	SCOOTER MBK	1991-				
	CT 50 SS	1995-	YAMA-27DP	344	YAMA-27DP	344
			YAMA-27P	344	YAMA-27P	344
	DT 125	-1985	YAMA-3D	343	YAMA-3D	343
	DT 125 LC.	-1985	YAMA-3I	343	YAMA-3I	343
	DT 125	1992-	YAMA-18D	343	YAMA-18D	343
	DT 125 B	1992-	YAMA-18I	343	YAMA-18I	343
	DT 125 R	1992-	YAMA-19D	343	YAMA-19D	343
	DT 125 Z	1992-	YAMA-19I	343	YAMA-19I	343
	TT 600	1993-	YAMA-20D	343	YAMA-20D	343
	TT 600 S	1991-	YAMA-20I	343	YAMA-20I	343
	TZR 125 R	1992-	YAMA-22DP	344	YAMA-22DP	344
	TZR 125 RSP	1992-	YAMA-22IP	344	YAMA-22IP	344
	XT 600 A	1993-	YAMA-23DP	344	YAMA-23DP	344
	XT 600 E	1991-	YAMA-23IP	344	YAMA-23IP	344
	XT 600 ZA	1991-1992	YAMA-24DP	344	YAMA-24DP	344
			YAMA-24IP	344	YAMA-24IP	344
			YAMA-28P	344	YAMA-28P	344
			YAMA-29P	344	YAMA-29P	344
	DT 125 CO.	1986-1992	ZA-1	345	ZA-1	345

FOR: PARA:	MODEL MODELO			PAG.		PAG.
<b>YAMAHA</b> ®	DT 125 LC.	1986-1992	ZA-1P	345	ZA-1P	345
			YAMA-18D	343	YAMA-18D	343
			YAMA-18DP	344	YAMA-18DP	344
	DT 125 R	1986-1991	YAMA-18I	343	YAMA-18I	343
			YAMA-18IP	344	YAMA-18IP	344
			YAMA-19D	343	YAMA-19D	343
			YAMA-19DP	344	YAMA-19DP	344
			YAMA-19I	343	YAMA-19I	343
			YAMA-19IP	344	YAMA-19IP	344
			YAMA-20D	343	YAMA-20D	343
			YAMA-20I	343	YAMA-20I	343
			YAMA-20IP	344	YAMA-20IP	344
			YAMA-22DP	344	YAMA-22DP	344
			YAMA-22IP	344	YAMA-22IP	344
			YAMA-23DP	344	YAMA-23DP	344
			YAMA-23IP	344	YAMA-23IP	344
			YAMA-24DP	344	YAMA-24DP	344
			YAMA-24IP	344	YAMA-24IP	344
			YAMA-28P	344	YAMA-28P	344
			YAMA-29P	344	YAMA-29P	344
	DT 250	-19-	YAMA-14D	343	YAMA-14D	343
	DT 250 MX	-19-	YAMA-14I	343	YAMA-14I	343
	RD 250	-19-	YAMA-15D	343	YAMA-15D	343
			YAMA-15I	343	YAMA-15I	343
			YAMA-3D	343	YAMA-3D	343
			YAMA-3I	343	YAMA-3I	343
	FJ 1100	1984-	YAMA-21I	344	YAMA-21I	344
	FJ 1200	1984-	YAMA-21IP	344	YAMA-21IP	344
	FS 1200	1984-				
	FZ 600	1984-				
	FZ 600 GE.	1984-				
	FZ 750 A-R	1984-				
	FZR 600	1992-				
	FZR 1000	1984-				
	FZR 1000 E.	1984-				
	FZX 750	1984-				
	GENESIS FZR	1992-				
	RD 500 YP.	1984-				
	SUPER T. 750	1992-				
	TDM 850	1991-				
	TT 350	1984-1991				
	TT 600 S	1984-1991				
	XJ 400	1984-				
	XJ 600 N	1984-				
	XJ 650 T	1984-				
	XJ 650 TU.	1984-				
	XJ 750 N	1984-				
	XJ 750 S.	1984-				
	XTZ 750	1984-				
	XTZ 750 T.	1984-				
	XV 500 SE	1984-				
	XV 750 SE	1984-				
	XV 1000 V.	1984-				
	XV 1100	1984-				
	FRZ 600	1995-	YAMA-26	344	YAMA-26	344
	FRZ 600 R	1994-	YAMA-26D	344	YAMA-26D	344
	GTS 1000	1993-	YAMA-26DP	344	YAMA-26DP	344

FOR: PARA:	MODEL MODELO			PAG.		PAG.
<b>YAMAHA</b> ®	GTS 1000 ABS	1993-	YAMA-26P	344	YAMA-26P	344
	TDM	1996-				
	TDM 850	1995-				
	TRX 850	1995-				
	XJ 600 E	1995-				
	XJ 600 S D.	1995-				
	XJ 900 S D.	1995-				
	XT 500	1979-1984				
	XT 600 E	1995-				
	XTZ 660	1994-				
	XVS 110 D.S.	1998-				
	XVS 650	1996-				
	XVZ 1300	1996-				
	YP 250 MAJES	1996-				
	YZF 600	1996-				

Motocicleta  
Motozikleta  
Motos

Motorrad  
Motociclos  
Motocykli

FOR: PARA:	MODEL MODELO			PAG.		PAG.
<b>YAMAHA</b>						
	YAMA-26DP	344	YAMA-26P	344		
	YAMA-26P	344				
	YAMA-29P	344				
FZX 750	1995-	YAMA-18D	343	NE-8	343	
		YAMA-22DP	344			
MAJESTY 250	2005-	ZA-9P1	345	ZA-9P1	345	
RD 50 M	-19-	YAMA-14D	343	YAMA-14D	343	
XT 50	-19-	YAMA-14I	343	YAMA-14I	343	
RD 350	-19-	YAMA-3D	343	YAMA-3D	343	
		YAMA-3I	343	YAMA-3I	343	
		YAMA-9D	343	YAMA-9D	343	
		YAMA-9I	343	YAMA-9I	343	
		YAMA-17D	343	YAMA-17D	343	
		YAMA-17I	343	YAMA-17I	343	
RD 500 LC	1984-	YAMA-18D	343	NE-8	343	
XJ 550	1984-	YAMA-18DP	344	YAMA-21I	344	
XS 400	1984-	YAMA-18I	343	YAMA-21IP	344	
		YAMA-18IP	344			
		YAMA-19D	343			
		YAMA-19DP	344			
		YAMA-19I	343			
		YAMA-19IP	344			
		YAMA-20D	343			
		YAMA-20I	343			
		YAMA-20IP	344			
		YAMA-21I	344			
		YAMA-21IP	344			
		YAMA-22DP	344			
		YAMA-22IP	344			
		YAMA-23DP	344			
		YAMA-23IP	344			
		YAMA-24DP	344			
		YAMA-24IP	344			
		YAMA-28P	344			
		YAMA-29P	344			
RS 125 C.	-1986	YAMA-5D	343	YAMA-5D	343	
		YAMA-5I	343	YAMA-5I	343	
SR 500 G	1979-1984	YAMA-14I	343	NE-8	343	
		YAMA-14D	343			
SR 500 S	1979-1984					
XT 500	1979-1984					
TDR 125	1992-	YAMA-18I	343	ZA-1	345	
TDR 125 R	1992-	YAMA-18IP	344	ZA-1P	345	
TDR 125 R	1990-1991	YAMA-19I	343	ZA-1	345	
		YAMA-19IP	344	ZA-1P	345	
TT 600	1994-	YAMA-20D	343	YAMA-20D	343	
TT 600 E	1994-					
XT 600 A	1994-					
XT 600 E	1994-					
TT 600	1995-	YAMA-20I	343	YAMA-20I	343	
XT 600 A	1995-	YAMA-24IP	344	YAMA-24IP	344	
XT 600 E	1995-	YAMA-28P	344	YAMA-28P	344	
TW 200	1995-	YAMA-19I	343	NE-8	343	
		YAMA-23IP	344			
		YAMA-29P	344			
TX 650	1979-	YAMA-3D	343	YAMA-3D	343	
TX 750	1979-	YAMA-3I	343	YAMA-3I	343	

FOR: PARA:	MODEL MODELO			PAG.		PAG.
<b>YAMAHA</b>						
V MAX 86	1984-	YAMA-21I	344	YAMA-21I	344	
VMX 12 N	1984-	YAMA-21IP	344	YAMA-21IP	344	
XZV 12 T	1984-	YAMA-18I	343	YAMA-18I	343	
XZV 12 TD	1984-	YAMA-18IP	344	YAMA-18IP	344	
XZV 13 TD	1984-	YAMA-22DP	344	YAMA-22DP	344	
		YAMA-22IP	344	YAMA-22IP	344	
VARIOUS MODELS	-	YAMA-10D		YAMA-10D		
		YAMA-10I		YAMA-10I		
		YAMA-11D		YAMA-11D		
		YAMA-11I		YAMA-11I		
		YAMA-12D		YAMA-12D		
		YAMA-12I		YAMA-12I		
		YAMA-1D		YAMA-1D		
		YAMA-1I		YAMA-1I		
		YAMA-20DP		YAMA-20DP		
		YAMA-25DP		YAMA-25P		
		YAMA-25P		YAMA-2D		
		YAMA-2D		YAMA-2I		
		YAMA-2I		YAMA-32DP	344	
		YAMA-32DP	344	YAMA-33P1		
		YAMA-33P1		YAMA-34	344	
		YAMA-34	344	YAMA-34D	344	
		YAMA-34D	344	YAMA-36DP	345	
		YAMA-36DP	345	YAMA-4D		
		YAMA-4D		YAMA-6D		
		YAMA-6D		YAMA-6I		
		YAMA-6I		YAMA-7D		
		YAMA-7D		YAMA-7I		
		YAMA-7I		YAMA-8D		
		YAMA-8D		YAMA-8I		
		YAMA-8I				
VARIOUS MODELS	2005-	ZA-9P2		ZA-9P2		
XC 125 CYGN.	1995-	YAMA-18D	343	YAMA-18D	343	
		YAMA-22DP	344	YAMA-22DP	344	
XS 500	1979-	YAMA-13D	343	YAMA-13D	343	
		YAMA-13I	343	YAMA-13I	343	
		YAMA-14I	343	YAMA-14I	343	
XS 500 B	1979-	YAMA-3D	343	YAMA-3D	343	
		YAMA-3I	343	YAMA-3I	343	
		YAMA-9D	343	YAMA-9D	343	
		YAMA-9I	343	YAMA-9I	343	
XS 500 EV.	1985-	YAMA-13D	343	YAMA-13D	343	
		YAMA-13I	343	YAMA-13I	343	
XS 750	1979-	YAMA-13I	343	YAMA-13I	343	
XS 1100	1984-	YAMA-13D	343	NE-8	343	
XS 1100 S	1984-	YAMA-13I	343			
XT 250	1990-	YAMA-17I	343	NE-8	343	
YPUS 125	1990-					
XT 400	-19-	YAMA-14D	343	NE-8	343	
YSR 50	1990-	YAMA-18D	343	NE-8	343	
		YAMA-18I	343			
		YAMA-22DP	344			
		YAMA-22IP	344			
YZF-R3	2015-	YAMA-37D	344	YAMA-37D	344	

# Guide

## USER GUIDE FOR THIS CATALOGUE. BRAND INDEX

Guía de uso de este catálogo.  
índice de marcas

Katalogo hau erabiltzeko jarraibidea.  
Marken aurkibidea

Guide d'utilisation du catalogue.  
Index des marques

Leitfaden für die Nutzung dieses  
Katalogs. Markenverzeichnis

Guia de Utilização deste catálogo.  
Índice de marcas

Instrukcja korzystania z niniejszego  
katalogu. Spis marek

## KEY JMA. CATALOGUE C.12

The keys that appear in this catalogue are JMA parts manufactured by Alejandro ALTUNA S.A. or one of its subcontractors. They are designed for cylinders and locks made by the manufacturers whose trademarks are indicated in this catalogue. In accordance with legal requirements relating to industrial property rights, the trademarks or trade names indicated in this catalogue are the exclusive property of the manufacturers of the cylinders and locks, as well as automobile manufacturers, other constructors, distributors and users. The aforementioned trademarks or trade names are indicated simply for information purposes so that the lock to which our parts correspond can be recognised quickly and easily.

This catalogue is for the exclusive use of professional key copiers who use JMA parts. Data referring to the products in this catalogue are indicative in nature. Although the basic characteristics are maintained at all times, we reserve the right to make, without previous notice, any technical, aesthetic or other types of changes involved in the development of the products in question. Some of the keys in this new catalogue could be received either with the JMA reference and trademark or with another trademark from the ALTUNA group.

## LLAVES JMA. CATÁLOGO C.12

Las llaves que aparecen en este catálogo son piezas JMA fabricadas por Alejandro ALTUNA S.A. o un subcontratista de éste. Están diseñadas para cilindros y cerraduras de los fabricantes cuyas marcas se indican en este catálogo. Conforme a las disposiciones legales vigentes relativas a la propiedad industrial, las marcas o nombres comerciales indicados en este catálogo son propiedad exclusiva de los fabricantes de cilindros y cerraduras, así como de los fabricantes de automóviles, otros constructores, distribuidores y usuarios. Dichas marcas o nombres comerciales se indican en calidad simplemente informativa con el fin de reconocer con rapidez la cerradura a la que corresponden nuestras piezas.

Este catálogo está reservado exclusivamente a profesionales de la reproducción de llaves que utilizan piezas JMA. Los datos referentes a los productos de este catálogo tienen carácter indicativo. Manteniendo siempre las características básicas, nos reservamos el derecho de realizar, sin previo aviso, modificaciones técnicas, estéticas o de otro tipo, por razones de evolución de los productos en cuestión. Algunos modelos que están en este nuevo catálogo podrán recibirlos tanto con la marca y la referencia JMA como con otra marca del grupo ALTUNA.

## JMA GILTZAK. KATALOGO C.12

Katalogo honetan ageri diren giltzak Alejandro ALTUNA SA enpresak edo honek kontratatutako beste enpresa batek egindako JMA piezak dira. Katalogoan zehazten diren marken fabrikatzaileen zilindro eta sarrailatarako diseinatuta daude. Jabetza industrialari buruz indarrean dauden lege-xedapenekin bat etorriz, katalogo honetan zehaztutako merkatariza-markak edo izenak zilindro eta sarrailen fabrikatzaileen eta beste eraikitzaile, banatzaile eta erabiltzaile batzuen jabetza eskusibokoak dira. Merkataritza-marka edo izen horiek zehaztasun gehiago emateko adierazten dira, gure piezak zein sarrailari dagozkion beharrela ikusi ahal izateko.

Katalogo hau giltzen kopiak egiteko JMA piezak erabiltzen dituzten profesionalentzako da soilik. Katalogo honetako produktuei buruzko datuek izaera adierazgarria dute. Oinarrizko ezaugarriak gordez, produktuen bilakaeraren ondoriozko aldaketa teknikoak, estetikoak edo bestelakoak egiteko eskubidea dugu, aurretik horren berri eman beharrik gabe. Katalogo berri honetan dauden eredueta batzuk JMA marka eta erreferentziarekin nahiz ALTUNA taldeko beste marka batekin jaso ahal izango dira.

## CLÉS JMA. CATALOGUE C.12

Les clés figurant dans ce catalogue sont des pièces JMA fabriquées par Alejandro ALTUNA S.A. ou l'un de ses sous-traitants. Elles sont conçues pour les cylindres et les serrures des fabricants dont les marques figurent dans ce catalogue. Conformément aux dispositions légales en vigueur en matière de propriété industrielle, les marques ou les dénominations commerciales figurant dans ce catalogue sont la propriété exclusive des fabricants des cylindres et des serrures, mais aussi des constructeurs automobiles, des autres fabricants, distributeurs et utilisateurs. Ces marques et dénominations commerciales ne sont fournies qu'à titre d'information dans le but de pouvoir rapidement trouver la serrure à laquelle correspondent nos pièces.

Ce catalogue est destiné exclusivement aux professionnels de la reproduction de clés qui utilisent des pièces JMA. Les renseignements concernant les produits de ce catalogue ne sont fournis qu'à titre d'information. Tout en conservant les caractéristiques de base, nous nous réservons le droit de réaliser, sans préavis, des modifications techniques, esthétiques ou d'autres types pour des raisons d'évolution des produits concernés. Certains des modèles figurant dans ce nouveau catalogue peuvent être reçus avec la marque et la référence JMA ou une autre marque du groupe JMA.

## JMA-SCHLÜSSEL KATALOG C.12

Die in diesem Katalog dargestellten Schlüssel sind JMA-Teile, die von Alejandro ALTUNA S.A. oder einem seiner Subunternehmer gefertigt wurden. Sie sind für Schließzylinder und Schlösser der Hersteller ausgelegt, deren Marken in den Katalogen angegeben sind. Gemäß den geltenden gesetzlichen Bestimmungen zum gewerblichen Schutzrecht, sind die in diesem Katalog angegebenen Marken oder Handelsbezeichnungen das ausschließliche Eigentum der Hersteller von Schließzylindern und Schlössern, ebenso der Hersteller von Automobilen, anderen Herstellerfirmen, Vertriebsunternehmen und Benutzern. Diese Marken oder Handelsbezeichnungen sind nur in rein informativer Form angegeben, um schnell die Schlösser finden zu können, zu denen unsere Teile gehören.

Dieser Katalog ist ausschließlich für Fachleute im Bereich der Schlüsselkopie reserviert, die JMA-Teile verwenden. Die Angaben zu den Produkten in diesem Katalog dienen nur als Hinweis. Unter Beibehaltung der Grundeigenschaften behalten wir uns das Recht vor, ohne Vorankündigung, technische, ästhetische oder sonstige Änderungen vorzunehmen, wenn es die Weiterentwicklung der jeweiligen Produkte verlangt. Einige Modelle in unserem neuen Katalog erhalten Sie mit der Marke und Referenz von JMA, oder mit einer anderen Marke der Gruppe ALTUNA.

## CHAVES JMA. CATÁLOGO C.12

As chaves que aparecem neste catálogo são peças JMA fabricadas por Alejandro ALTUNA, S.A. ou um subcontratado desta. Estão desenhadas para cilindros e fechaduras dos fabricantes cujas marcas se indicam neste catálogo. Segundo as disposições legais vigentes relativas à propriedade industrial, as marcas ou as designações comerciais indicadas neste catálogo são propriedade exclusiva dos fabricantes de comandos, cilindros e fechaduras, assim como dos fabricantes de automóveis, outros construtores, distribuidores e utilizadores. As referidas marcas ou designações comerciais são indicadas apenas como informação, a fim de reconhecer rapidamente a fechadura a que correspondem as nossas peças.

Este catálogo está reservado exclusivamente a profissionais da reprodução de chaves que utilizam peças JMA. Os dados referentes aos produtos deste catálogo serão entendidos apenas como informação. Mantendo sempre as características básicas, reservamo-nos o direito de realizar, sem aviso prévio, alterações técnicas, estéticas ou outras, por razões de evolução dos referidos produtos. Alguns dos modelos deste novo catálogo estão disponíveis tanto sob a marca e referência JMA como sob outra marca do Grupo ALTUNA.

## KLUCZE JMA. KATALOG C.12

Klucze zaprezentowane w niniejszym katalogu stanowią elementy marki JMA wytwarzane przez firmę Alejandro ALTUNA S.A. lub jej podwykonawcę. Zostały zaprojektowane do wkładek i zamków producentów marek, które zostały przedstawione w niniejszym katalogu. Zgodnie z obowiązującymi przepisami dotyczącymi własności przemysłowej marki lub nazwy handlowe wskazane w niniejszym katalogu stanowią wyłączną własność producentów wkładek i zamków, jak również producentów samochodów, innych wytwórców, dystrybutorów i użytkowników. Wspomniane marki lub nazwy handlowe są prezentowane wyłącznie w celach informacyjnych, aby umożliwić szybkie wyszukiwanie zamków, do których pasują elementy oferowane przez firmę.

Niniejszy katalog jest przeznaczony wyłącznie dla specjalistów z branży kopiowania kluczy korzystających z produktów JMA. Dane dotyczące produktów zawartych w niniejszym katalogu mają charakter informacyjny. Przy każdorazowym zapewnieniu podstawowych właściwości produktów firma zastrzega sobie prawo do dokonywania zmian technicznych, estetycznych lub innych bez wcześniejszego powiadomienia, mając na celu rozwój oferowanych produktów. Niektóre modele przedstawione w niniejszym nowym katalogu mogą być dostarczane pod marką i modelem JMA lub pod inną marką Grupy ALTUNA.

# Legal warning

Aviso legal  
Lege-oharra  
Mentions légales  
Impressum  
Aviso legal  
Informacje prawne



**KEY IDENTIFICATION BY APPEARANCE**

All the keys in this catalogue are 1:1 scale; both the silhouette outline and profile, to facilitate a precise search.

Steps to follow for identifying the key:

**1. IDENTIFICATION OF THE SILHOUETTE**

**2. IDENTIFICATION OF THE PROFILE**

Make sure the profile of the catalogue has the same shape and dimension, by placing the physical key over the image in the catalogue.

**IDENTIFICACIÓN DE LLAVES POR APARIENCIA**

Todas las llaves del catálogo están en escala 1:1; tanto la silueta como el perfil, para hacer una búsqueda más fácil y precisa.

Pasos a seguir para la identificación de la llave:

**1. IDENTIFICACIÓN DE LA SILUETA**

**2. IDENTIFICACIÓN DEL PERFIL**

Cerciorar que el perfil del catálogo tiene la misma forma y dimensión, colocando la llave física sobre la imagen del catálogo.

**GILTZAK ITXURAREN ARABERA IDENTIFIKATZEA**

Katalogoko giltza guztiak 1:1 eskalan agertzen dira; hala silueta nola profila, bilaketa errazagoa eta zehatzagoa izan dadin.

Giltza identifikatzeko urratzak:

**1. SILUETA IDENTIFIKATZEA**

**2. PROFILA IDENTIFIKATZEA**

Katalogoko profilak forma eta dimentsio bera duela ziurtatzea, giltza fisikoa katalogoko irudiaren gainean jarritz.

**IDENTIFICATION DES CLÉS PAR L'APPARENCE**

Toutes les clés du catalogue sont à l'échelle 1:1; aussi bien la silhouette que le profil, afin de permettre une recherche plus simple et précise.

Étapes à suivre pour l'identification de la clé :

**1. IDENTIFIER LA SILHOUETTE**

**2. IDENTIFIER LE PROFIL**

S'assurer que le profil du catalogue a la même forme et les mêmes dimensions, en plaçant la clé physique sur l'image du catalogue.

**IDENTIFIZIERUNG DER SCHLÜSSEL NACH AUSSEHEN**

Alle Schlüssel des Katalogs sind im Maßstab 1:1 dargestellt; sowohl der Umriss als auch das Profil, um die Suche einfacher und präziser für Sie zu machen.

Bei der Identifizierung des Schlüssels einzuhaltende Schritte:

**1. IDENTIFIZIERUNG DES UMRISSES**

**2. PROFILIDENTIFIZIERUNG**

Sie finden heraus, ob das Profil im Katalog dieselbe Form und Abmessung hat, indem Sie den physischen Schlüssel auf die Abbildung im Katalog legen.

**IDENTIFICAÇÃO DA CHAVE PELA APARÊNCIA**

Todas as chaves do catálogo estão à escala 1:1, tanto a silhueta como o perfil, para facilitar a pesquisa e torná-la mais precisa.

Passos a seguir para a identificação da chave:

**1. IDENTIFICAÇÃO DA SILHUETA**

**2. IDENTIFICAÇÃO DO PERFIL**

Certifique-se de que o perfil do catálogo tem a mesma forma e dimensão, colocando a chave física na imagem do catálogo.

**OKREŚLENIE KLUCZY NA PODSTAWIE ICH CECH ZEWNĘTRZNYCH**

Wszystkie klucze przedstawione w katalogu zostały zaprezentowane w skali 1:1 zarówno jeśli chodzi o przekrój klucza, jak i jego profil, w celu ułatwienia dokładniejszego wyszukiwania.

Aby zidentyfikować klucz, należy wykonać następujące czynności:

**1. ZIDENTYFIKOWAĆ PRZEKRÓJ KLUCZA**

**2. ZIDENTYFIKOWAĆ PROFIL KLUCZA**

Upewnić się, że profil przedstawiony w katalogu ma identyczny kształt i wymiary, umieszczając fizyczny klucz na rysunku w katalogu.

# Manual of use

Manual de uso  
Erabilera-eskuliburua  
Guide d'utilisation  
Gebrauchsanweisung  
Manual de Utilização  
Instrukcja obsługi



1. IDENTIFICATION OF THE SILHOUETTE

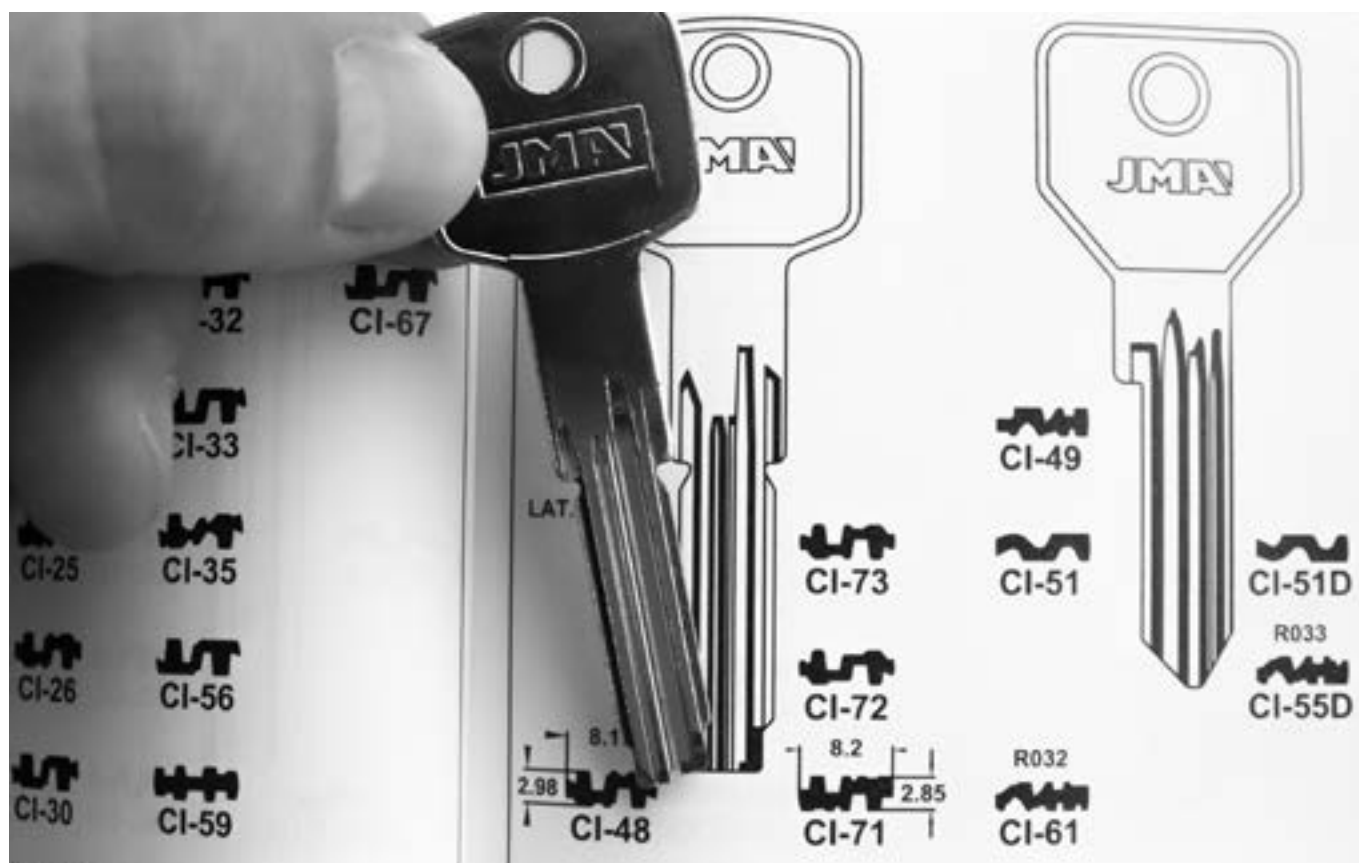

2. IDENTIFICATION OF THE PROFILE

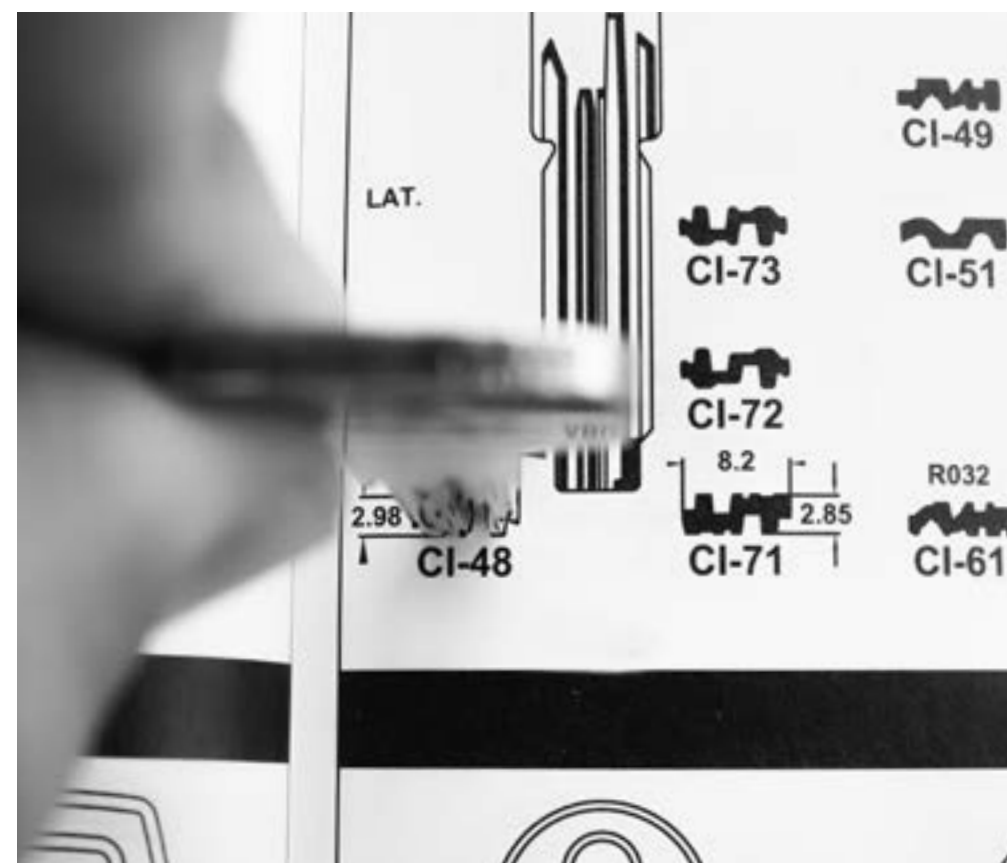



TERMINOLOGY

TERMINOLOGÍA

TERMINOLOGIA

TERMINOLOGIE

1. MAIN BRAND
2. HEAD
3. NECK
4. SHOULDER
5. BLADE
6. TIP
7. USE
8. ORIGINAL PROFILE
9. LEFT PROFILE
10. RIGHT PROFILE
11. REFERENCE
12. SECONDARY BRAND
13. SERIES
14. MAIN BRAND AND NATIONALITY
15. SECONDARY BRANDS OF THE MAIN ONE (ABSA)

1. MARCA PRINCIPAL
2. CABEZA
3. CUELLO
4. TOPE
5. PALETÓN
6. PUNTA
7. UTILIZACIÓN
8. NOMENCLATURA DE PERFIL ORIGINAL
9. PERFIL IZQUIERDO
10. PERFIL DERECHO
11. REFERENCIA
12. MARCAS SECUNDARIAS
13. SERIES
14. MARCA PRINCIPAL
15. MARCAS SECUNDARIAS DE LA PRINCIPAL (ABSA)

1. MARKA NAGUSIA
2. BURUA
3. LEPOA
4. TOPEA
5. BELARRIA
6. PUNTA
7. ERABILERA
8. JATORRIZKO PROFILAREN IZENDEGIA
9. EZKERREKO PROFILA
10. ESKUINEKO PROFILA
11. ERREFERENTZIA
12. BIGARREN MAILAKO MARKAK
13. SERIEAK
14. MARCA NAGUSIA ETA JATORRIZKOA
15. MARKA NAGUSIAREN BIGARREN MAILAKO MARKAK (ABSA)

1. MARQUE PRINCIPALE
2. TÊTE
3. COU
4. ARRÊT
5. CANON
6. POINTE
7. UTILISATION
8. PROFIL ORIGINAL
9. PROFIL GAUCHE
10. PROFIL DROIT
11. RÉFÉRENCE MARQUE
12. SECONDAIRE
13. CODE
14. MARQUE PRINCIPALE ET NATIONALITÉ
15. MARQUES SECONDAIRES DE LA PRINCIPALE (ABSA)

TERMINOLOGIE

TERMINOLOGIA

OBJAŚNIENIE TERMINÓW

1. HAUPTPRÄGUNG
2. KOPF
3. HALS
4. ANSCHLAG
5. SCHAFT
6. SPITZE
7. VERWENDUNG
8. ORIGINALPROFIL
9. LINKSPROFIL
10. RECHTSPROFIL
11. BEZEICHNUNG
12. 2. PRÄGUNG
13. SERIE
14. HAUPTPRÄGUNG UND NATIONALITÄT
15. 2. PRÄGUNG FÜR HAUPTPRÄGUNG (ABSA)

1. MARCA PRINCIPAL
2. CABEÇA
3. GOLA
4. BATENTE
5. PALHETÃO
6. PONTA
7. UTILIZAÇÃO
8. NOMENCLATURA DO PERFIL ORIGINAL
9. PERFIL ESQUERDO
10. PERFIL DIREITO
11. REFERÊNCIA
12. MARCAS SECUNDÁRIAS
13. SÉRIES
14. MARCA PRINCIPAL
15. MARCAS SECUNDÁRIAS DA PRINCIPAL (ABSA)

1. MARKA GŁÓWNA
2. GŁÓWKA
3. SZYJKA
4. ZDERZAK
5. GROT
6. CZUBEK
7. PRZEZNACZENIE
8. NAZEWNICTWO PROFILU ORYGINALNEGO
9. PROFIL LEWY
10. PROFIL PRAWY
11. SYMBOL
12. MARKI DRUGORZĘDNE
13. SERIE
14. MARKA GŁÓWNA
15. MARKI DRUGORZĘDNE WOBEC MARKI GŁÓWNEJ (ABSA)

# Description

- Descripción
- Deskribapena
- Description
- Beschreibung
- Descrição
- Opis

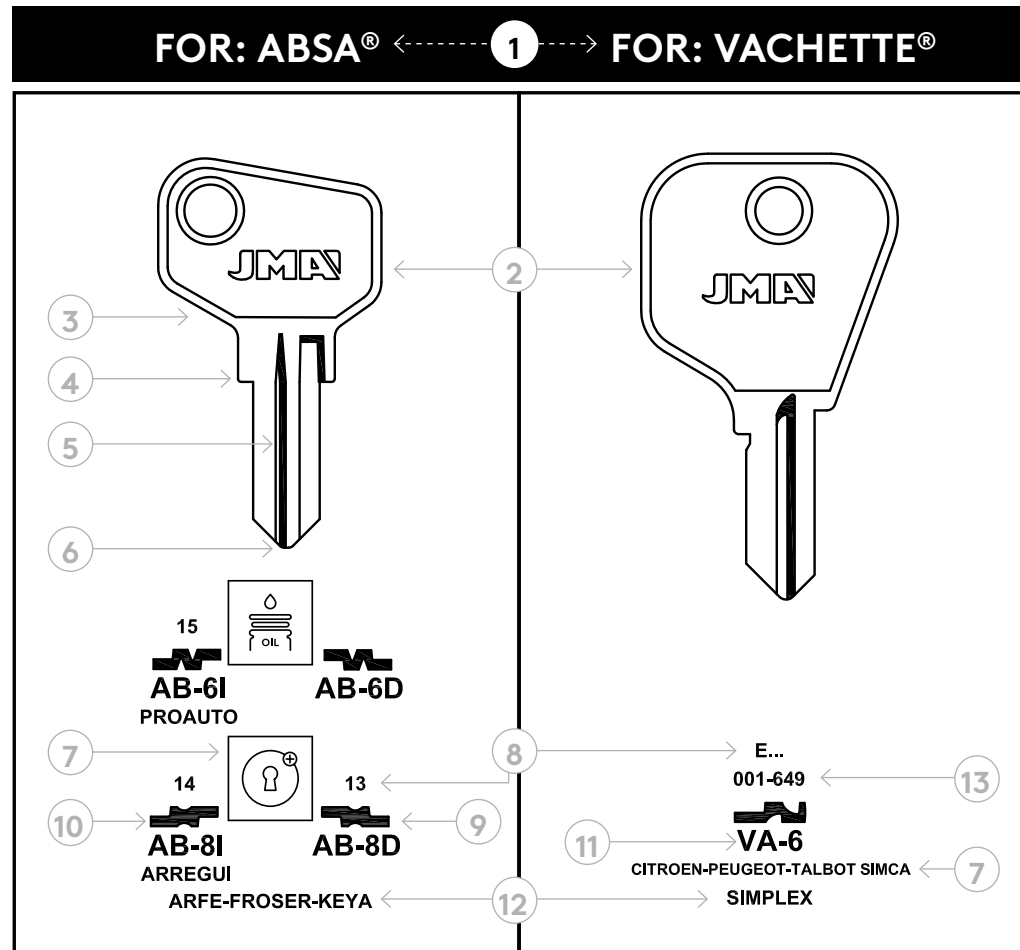
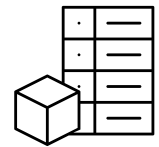

TERMINOLOGY

1. HEAD
2. NECK
3. SHANK
4. DIAMETER
5. SHANK
6. LENGTH A
7. BIT PIN BIT PROFILE
8. REFERENCE
9. ORIGINAL BRAND
10. PIPE BIT PROFILE

TERMINOLOGÍA

1. CABEZA
2. CUELLO
3. DIÁMETRO DE LA CAÑA
4. CAÑA
5. LONGITUD A
6. PALETON
7. PERFIL MACHO
8. REFERENCIA
9. MARCA ORIGINAL
10. PERFIL HEMBRA

TERMINOLOGIA

1. BURUA
2. LEPOA
3. ZIRIAREN DIAMETROA
4. ZIRIA
5. A LUZERA
6. BELARRIA
7. PROFIL ARRA
8. ERREFERENTZIA
9. JATORRIZKO MARKA
10. PROFIL EMEA

TERMINOLOGIE

1. TÊTE
2. COU
3. DIAMETRE DU CANON
4. CANON
5. LONGUEUR A
6. PANNETON
7. PROFIL MALE
8. RÉFÉRENCE
9. MARQUE ORIGINALE
10. PROFIL FEMELLE

TERMINOLOGIE

1. KOPF
2. HALS
3. HALM-DURCHMESSER
4. HALM
5. LÄNGE A
6. BART
7. SCHWEIFUNG
8. BEZEICHNUNG
9. ORIGINAL-PRÄGUNG
10. GEBOHRT

TERMINOLOGIA

1. CABEÇA
2. GOLA
3. DIÂMETRO DA CANA
4. CANA
5. COMPRIMENTO A
6. PALHETÃO
7. PERFIL MACHO
8. REFERÊNCIA
9. MARCA ORIGINAL
10. PERFIL FÊMEA

OBJAŚNIENIE TERMINÓW

1. GŁÓWKA
2. KOŁNIERZ
3. ŚREDNICA RURKI
4. RURKA
5. DŁUGOŚĆ A
6. PŁETWA
7. PROFIL
8. SYMBOL
9. MARKA ORYGINALNA
10. PROFIL

# Description

- Descripción
- Deskription
- Description
- Beschreibung
- Descrição
- Opis

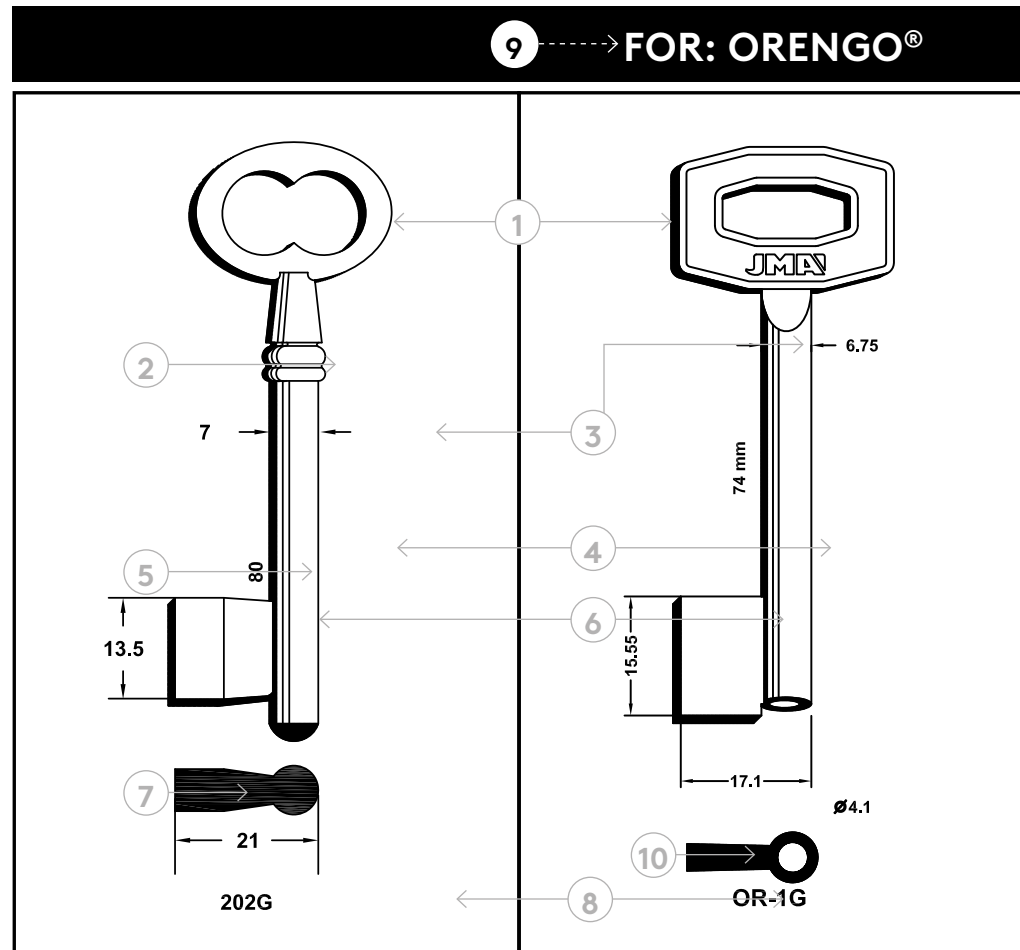
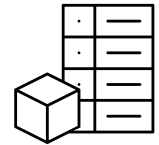

## COUNTRY CODES

Códigos por país  
Herrialde-kodeak  
Codes pays  
Ländercodes  
Códigos por país  
Kody wg kraju

<b>A</b>	AUSTRIA
<b>AUS</b>	AUSTRALIA
<b>B</b>	BELGIUM
<b>BR</b>	BRAZIL
<b>CDN</b>	CANADA
<b>CH</b>	SWITZERLAND
<b>D</b>	GERMANY
<b>DK</b>	DENMARK
<b>DZ</b>	ALGERIA
<b>E</b>	SPAIN
<b>ES</b>	ESLOVAKIA
<b>ET</b>	EGYPT
<b>F</b>	FRANCE
<b>GB</b>	GREAT BRITAIN
<b>GR</b>	GREECE
<b>H</b>	HUNGARY
<b>HK</b>	HONG KONG
<b>HR</b>	CROATIA
<b>I</b>	ITALY
<b>IL</b>	ISRAEL
<b>IND</b>	INDIA
<b>IRL</b>	EIRE
<b>J</b>	JAPAN
<b>K</b>	KOREA
<b>KW</b>	KUWAIT
<b>MEX</b>	MEXICO
<b>N</b>	NORWAY
<b>NL</b>	THE NETHERLANDS
<b>P</b>	PORTUGAL
<b>PE</b>	PERU
<b>PL</b>	POLAND
<b>RA</b>	ARGENTINA
<b>RC</b>	TAIWAN
<b>RCH</b>	CHILE
<b>RCZ</b>	CHEKIA
<b>RU</b>	RUMANIA
<b>S</b>	SWEDEN
<b>SF</b>	FINLAND
<b>SLO</b>	SLOVENIA
<b>RUS</b>	RUSIA
<b>TJ</b>	CHINA
<b>TN</b>	TUNISIA
<b>USA</b>	UNITED STATES OF AMERICA
<b>YU</b>	YUGOSLAVIA
<b>YV</b>	VENEZUELA
<b>Z</b>	ZAMBIA

## MATERIAL ABBREVIATIONS

Abreviaturas materiales  
Laburdura materialak  
Abréviations matérielles  
Materielle Abkürzungen  
Abreviaturas dos materiais  
Skróty materiałowe

### ALP.

**Key available in nickel silver**  
Llave fabricada en alpaca  
Alpakaz egindako giltza  
Clé fabriquée en maillechort  
Schlüssel auch in Neusilber lieferbar  
Chave também disponível em níquel-prata  
Klucze z mosiądzu wysokoniklowego

### LAT.

**Key also available in brass**  
Llave disponible también en latón  
Giltza, letoizkoa ere eskuragarria  
Clé aussi disponible en laiton  
Schlüssel auch in Messing lieferbar  
Chave também disponível em latão  
Klucz dostępny również w wykonaniu mosiężnym

### COL.

**Available with coloured plastic head**  
Disponible con cabeza de plástico en colores  
Koloretako plastikozko buruarekin eskuragarri  
Disponibile avec tête plastifiée en couleurs  
Erhältlich mit farbigem Kunststoffkopf  
Disponível com cabeça de plástico às cores  
Dostępny z kolorową główką z tworzywa sztucznego

### ALU.

**Key also available in aluminium**  
Llave disponible también en aluminio  
Giltza, aluminioan ere eskuragarria  
Clé aussi disponible en aluminium  
Schlüssel auch in Aluminium lieferbar  
Chave também disponível em alumínio  
Klucz dostępny również w wykonaniu aluminiowym

### ZAM.

**Key only available in zamak**  
Llave fabricada solamente en zamak  
Zamakez soilik egindako giltza  
Clé aussi disponible en zamak  
Schlüssel nur aus Zamak lieferbar  
Chave fabricada apenas em zamak  
Klucz produkowany wyłącznie ze znanu

### PLAS.

**Key also available in plastic**  
Llave disponible también en plástico  
Giltza, plastikoa ere eskuragarria  
Clé aussi disponible en plastique  
Schlüssel auch in Plastik lieferbar  
Chave também disponível em plástico  
Klucz dostępny również w wykonaniu plastikowym

## CONVENTIONAL SIGNS

Signos convencionales  
Zeinu konbentzionalak  
Signes conventionnels  
Herkömmliche Zeichen  
Sinais convencionais  
Znaki konwencjonalne

 **Key for padlocks**  
Llave para candados  
Giltzarrapoetan erabiltzeko giltzak  
Clé pour cadenas  
Schlüssel für Hangschlösser  
Chave para cadeados  
Klucz do klódek

 **Key for cam locks**  
Llave para cerradura auxiliar  
Sarraila osagarrirako giltza  
Clé pour petite serrurie  
Schlüssel für Hebelschlösser  
Chave para fechadura auxiliar  
Dodatkowy klucz do zamka

 **Key for motorcycles**  
Llaves para motocicletas  
Motozikleta giltzak  
Clé pour motocyclettes  
Schlüssel für Motorräder  
Chaves para motocicletas  
Kluczyki do motocykli

 **Key for fuel cap**  
Llave para tapón de gasolina  
Gasolina-tapoietarako giltza  
Clé pour bouchon d'essence  
Schlüssel für Tankdeckel  
Chave para tampão do depósito da gasolina  
Klucz do wlewu paliwa

 **Key for lorries**  
Llave para camión  
Kamioiko giltza  
Clé pour camion  
Schlüssel für Lastkraftwagen  
Chave para camião  
Kluczyk do pojazdu ciężarowego

 **Alarm**  
Alarma  
Alarma  
Alarme  
Alarm  
Alarme  
Alarm

 **Bit key blank natural finishing**  
Llave gorja acabado natural  
Akabera naturaleko gorja giltzak  
Clé à gorges finition naturel  
Chubbschlüssel in naturfarben  
Ausführung  
Chave gorja acabamentoo natural  
Klucz zasuwowy w wykończeniu naturalnym

 **Bit key blank with old black finishing**  
Llave gorja acabado negro antiguo  
Beltz zaharkitu akabera gorja giltza  
Clé à gorges finition noir  
Chubbschlüssel in altschwarzer  
Ausführung  
Chave gorja acabamentoo preto envelhecido  
Klucz zasuwowy w wykończeniu antycznej czerni

## DESCRIPTIVE SYMBOLOGY

Simbología descriptiva  
Zeinu konbentzionalak  
Signes conventionnels  
Herkömmliche Zeichen  
Simbologia descriptiva  
Symbole opisowe

 **Calendar**  
Calendario  
Egutegia  
Calendrier  
Kalender  
Calendário  
Kalendarz

 **Engine ignition**  
Contacto auto  
Autoko kontaktua  
Contact auto  
Zündschloss Pkw  
Contacto auto  
Stacyjka samochodu

 **Door lock**  
Puerta auto  
Autoko atea  
Portière  
Türe  
Porta auto  
Drzwi samochodu

 **Boot/ Hatchback**  
Maletero / Puerta trasera  
Maletategia / Atzeko atea  
Coffre / Haillon  
Kofferraum / Hecktür  
Porta-bagagens / Porta traseira  
Bagażnik / tylne drzwi

 **Petrol cap**  
Tapón de gasolina  
Gasolina-tapoa  
Bouchon réservoir  
Benzintankverschluss  
Tampão do depósito da gasolina  
Wlew paliwa

 **Drawer**  
Guantera  
Eskularru-kutxa  
Tiroir  
Schublade  
Porta-luvas  
Schowek

 **Motorbike ignition**  
Contacto moto  
Moto-kontaktua  
Contact moto  
Zündschloss Motorrad  
Contacto moto  
Stacyjka motocyklu

 **Motorbike disc lock**  
Bloqueo moto  
Moto-blokea  
Bloquentage moto  
Bremsenschloss Motorrad  
Bloqueio moto  
Blokada motocyklu

 **Cycle seat**  
Sillín  
Zela  
Selle  
Sattel  
Selim  
Siodefko

 **Helmet**  
Casco  
Kaskoa  
Casque  
Helm  
Capacete  
Kask

 **Car / Pick-up trucks**  
Automovil / Camioneta  
Automobila / Kamioneta  
Voiture / Camionnette  
Auto / Kleintransporter  
Automóvel / Camioneta  
Samochód / furgonetka

 **Motorcycle**  
Motocicleta  
Motozikleta  
Motocyclette  
Motorrad  
Motocicleta  
Motocykl

 **Truck**  
Camión  
Kamioia  
Camion  
Lkw  
Camião  
Pojazd ciężarowy

 **Aeroplane**  
Avión  
Hegazkia  
Avion  
Flugzeuge  
Avião  
Samolot

 **Caravan**  
Caravana  
Karabana  
Caravane  
Wohnwagen  
Caravana  
Samochód kempingowy

 **Boat engines**  
Motor marino  
Itsas motorra  
Moteur de bateau  
Schiffsmotoren  
Motor náutico  
Silnik do statków

 **Bicycle**  
Bicicleta  
Bizikleta  
Bicyclette  
Fahrräder  
Bicicleta  
Rower

# Symbol and codes

Símbolos y códigos  
 Sinboloak eta kodeak  
 Symboles et codes  
 Symbole und codes  
 Símbolos y códigos  
 Symbole i Kody

 **Ski holder**  
Portaesquis  
Eski-euskarria  
Porte ski  
Skiträger  
Porta-esquis  
Uchwyt na narty

 **Tractor**  
Tractor  
Traktorea  
Tracteur  
Landmaschinen  
Trator  
Ciągnik

 **Earth moving machine**  
Escavadora  
Hondeatzailea  
Excavatrice  
Baumaschinen  
Escavadora  
Koparka

 **Forklift**  
Carretilla elevadora  
Orga jasotzailea  
Chariot élévateur  
Gabelstapler  
Empilhador  
Wózek widłowy

 **Lawn-mower**  
Corta césped  
Belarra mozteko makina  
Tondeuse  
Rasenmäher  
Cortador de relva  
Kosiarka

# Guide

**BENCHMARK INDEX**

Índice de referencias  
Erreferentzia aurkibidea  
Index des références  
Referenzverzeichnis  
Índice de referências  
Spis modeli



Índice de referencias  
Erreferentzia aurkibidea  
Index des références

Referenzverzeichnis  
Índice de referências  
Spis modeli

REF.	PAG.	REF.	PAG.	REF.	PAG.	REF.	PAG.	REF.	PAG.	REF.	PAG.	REF.	PAG.	REF.	PAG.	REF.	PAG.	REF.	PAG.	
1G	398	203G	384	620G	389	1626G	397	ABL-6	2	ABU-32D	5	ABU-72P	6	AD-24	400	AF-7D	156, 165, 167, 179,	AF-9DP	156, 165, 168, 179,	
2G	398	204G	384	622G	390	A-0G	456	ABU-1	3	ABU-34	124	ABU-72P	346	AD-25	400		184, 185, 188, 192,		184, 185, 188, 192,	
3G	398	205G	384	623G	390	A-0G(CV)	456	ABU-1D	3	ABU-35DP	150	ABU-73D	6	AD-26	400		219, 227, 228,		219, 228, 228,	
3M-1D	2	206G	384	624G	390	A-1G	456	ABU-2D	3	ABU-35DP	5	ABU-74	3	AD-27	400		233, 246, 256,		233, 246, 256,	
4G	398	207G	384	625G	390	A-1G(CV)	456	ABU-2G	443	ABU-35DP	346	ABU-74D	3	AD-28	400		267, 271, 299, 317,		268, 271, 296,	
5G	398	208G	385	626G	390	A-1G-1	456	ABU-2I	3	ABU-35P	150	ABU-75D	6	AD-29	400		319, 325, 336,		299, 310, 317,	
5-L	104	209G	385	716-1G	402	A-1G-2	456	ABU-3	3, 346	ABU-35P	5	ABU-76	3	AD-33T	442		338		320, 325, 336,	
6-C	112	210G	385	716-2G	402	A-1G-3	456	ABU-4D	3	ABU-35P	346	ABU-77	5	AD-44-1	400	AF-7DP	299, 317, 320,		338	
6G	398	213G	385	1200G	391	A-1G-4	456	ABU-4I	3	ABU-36P	150	ABU-78	6	AD-44-2	400		325, 336, 338	AF-9I	156, 165, 167, 179,	
6-L	112	214G	385	1201G	391	A-1G-5	456	ABU-5D	3	ABU-36P	5	ABU-79	6	AD-44-3	400	AF-7I	156, 165, 167, 179,		184, 185, 188, 192,	
7G	398	216G	385	1202G	391	A-1G-6	456	ABU-6D	3	ABU-36P	346	ABU-80	5	AD-44-4	400		184, 185, 188, 192,		219, 227, 228,	
7-S	91	217G	386	1203G	391	A-2G	456	ABU-6I	3	ABU-37D	3	ABU-81	124	AD-44-5	400		219, 227, 228,		233, 246, 256,	
7-S	460	219G	386	1204G	391	A-2G(CV)	456	ABU-7D	3	ABU-38D	5	ABU-83	5	AD-44-6	400		233, 246, 256,		267, 271, 296,	
8G	398	221G	386	1205G	391	A-2G-1	456	ABU-8D	3	ABU-39P	5	ABU-84D	6	AD-46	446		267, 271, 296,		299, 310, 317, 319,	
8M-1D	81	223G	386	1206G	391	A-3G	456	ABU-8I	3	ABU-40	5	ABU-85	5	AD-47	446	AF-7I	317, 319, 325,	AF-9IP	156, 165, 168, 179,	
11G	398	224G	386	1207G	391	A-3G(CV)	456	ABU-9D	3	ABU-40	346	ABU-86D	6	ADPLE-11	401		336, 338		184, 185, 188, 192,	
12G	398	225G	386	1208G	392	A-4G	456	ABU-9I	3	ABU-41	5	ABU-87P	6	ADPLE-22	401	AF-7IP	156, 165, 168, 179,		219, 228, 228,	
13G	399	226G	386	1209G	392	A-5G	456	ABU-10D	3	ABU-41D	5	ABU-87P	346	ADPLE-33	401		184, 185, 188, 192,		233, 256, 256,	
	399	228G	386	1210G	392	AA-1G	456	ABU-10I	3	ABU-42	5	ABU-88P	6	ADPLE-44	401		219, 228, 228,		268, 271, 296,	
15-D	185	229G	386	1211G	392	AA-1G(CV)	456	ABU-11	4	ABU-42	346	ABU-88P	346	ADS-1D	7		233, 246, 256,		299, 310, 317, 319,	
15G	399	231G	386	1212G	392	AA-2G	456	ABU-11D	4	ABU-42D	5	ABU-89D	6	AEP-1D	7	AF-7I	268, 271, 296,	AF-10	157, 219, 228,	
15-I	185	232G	387	1213G	392	AA-2G(CV)	456	ABU-12D	3	ABU-42D	346	ABU-90	6	AEP-2D	7		299, 310, 317,		325, 336, 338	
16G	399	233G	387	1214G	393	AA-3G	457	ABU-12I	3	ABU-43D	3	ABU-91	124	AF-2D	156, 156, 165, 185	AF-8D	156, 165, 167, 179,	AF-11	157, 219, 228,	
17G	399	234G	387	1215G	393	AA-3G(CV)	457	ABU-13	4	ABU-44	3	ABU-92	5	AF-2I	156, 156, 165, 185		184, 185, 188, 192,		233	
19G	399	236G	387	1216G	393	AB-1D	3	ABU-13	346	ABU-45	5	ABU-92D	5	AF-3D	156		219, 227, 228,	AF-12	157, 219, 228,	
21G	399	237G	387	1217G	393	AB-1I	3	ABU-13D	4	ABU-45	346	ABU-93	6	AF-3I	156		233, 246, 256,		233	
23G	399	238G	387	1218G	393	AB-1T	146	ABU-13D	346	ABU-46	3	ABU-94D	6	AF-4D	185, 227, 246, 256		267, 271, 296,	AF-13	157	
24G	399	239G	387	1219G	393	AB-2D	3	ABU-14	3	ABU-46D	3	ABU-96	124	AF-4I	185, 227, 246,		299, 310, 317, 319,	AF-13P	157	
25G	399	303-1	2	1220G	393	AB-2I	3	ABU-15	3	ABU-47	3	ABU-99D/1	5		256	AF-14	299, 310, 317, 319,	AF-14P	157	
26-M	86, 46	303-1D	2	1221G	393	AB-2T	146	ABU-15D	3	ABU-48	5	ABU-99D/2	5	AF-5D	150, 156, 165, 179		325, 336, 338	AF-14P	157, 165, 185,	
35-D	112	333-1D	2	1241G	393	AB-3I	3	ABU-16	124	ABU-49	3	ABU-99D/3	5		184, 185, 188, 192	AF-8DP	156, 165, 168, 179,	AF-14P	228, 299	
35-I	112	333-2D	2	1242G	394	AB-3T	146	ABU-17	6	ABU-50	5	ABU-100	5		218, 227, 233,		184, 185, 188, 192,	AF-14P	320, 322, 323,	
38-D	112	500	300	1243G	394	AB-4T	146	ABU-17D	6	ABU-51D	5	ABU-101P	6		246, 256, 267,		219, 228, 228,		324, 325	
38-I	112	501	300	1244G	394	AB-5D	3, 172	ABU-18DP	4	ABU-52D	3	ABU-102	124		282, 299, 318,	AF-19	233, 246, 256,	AF-19	151, 159, 166, 183,	
45-1	2	502	300	1245G	394	AB-5I	3, 172	ABU-18DP	346	ABU-53	3	ABU-103DP	6		324, 325, 326,		268, 271, 296,		184, 187, 189, 190,	
45-1D	2	503	300	1246G	394	AB-6D	3, 150, 193,	ABU-18P	4	ABU-54	5	ABU-103DP	346		327, 335, 338,		299, 310, 317,	AF-21P	151, 159, 166,	
45-2	2	504	300	1247G	394	AB-6I	3, 150, 193, 2	ABU-18P	346	ABU-54D	5	ABU-104DP	7		341		320, 325, 336,		191, 193, 226,	
45-2D	2	505	300	1248G	394		30, 274	ABU-19D	150	ABU-55	3	ABU-104DP	346	AF-5I	150, 156, 165, 179,		338		228, 246, 256,	
51G	441	506	300	1250G	394	AB-8D	3, 150, 193,	ABU-19D	4	ABU-55D	3	AC-9	460		184, 185, 168, 179,	AF-8I	156, 165, 167, 179,		269, 271, 282,	
52G	441	507	300	1252G	395		230, 274	ABU-19D	346	ABU-57	5	AC-12	460		192, 218, 227,		184, 185, 188, 192,		294, 296, 301,	
52GPC	441	508	300	1254G	395	AB-8I	3, 150, 193, 2	ABU-19DP	150	ABU-57D	5	AC-14	460		233, 246, 256,		219, 227, 228,	AF-19P	324, 347	
53G	441	509	300	1255G	395		30, 274	ABU-19DP	4	ABU-58D	5	AC-15	460		267, 282, 299,		233, 246, 256,		296, 301, 310,	
54G	441	510	300	1256G	395	AB-9D	3	ABU-19DP	346	ABU-60	5	AD-1	400		318, 324, 325,		267, 271, 296,	AF-21	347	
55G	442	512	300	1600G	395	AB-10I	172	ABU-19P	150	ABU-61	124	AD-2	400		327, 332, 335,		299, 310, 317, 319,		151, 159, 166, 183,	
56G	442	513	300	1602G	395	AB-11	3	ABU-19P	4	ABU-63	124	AD-3	400	AF-6D	150, 156, 165, 179,	AF-8IP	156, 165, 168,		184, 187, 189, 190,	
57G	442	600G	388	1603G	395	ABA-1	2	ABU-19P	346	ABU-64P	150	AD-4	400		184, 185, 188,		179, 184, 185, 188,		191, 193, 226,	
66G	442	601G	388	1604G	395	ABC-1	2	ABU-20	3	ABU-64P	5	AD-5	400		192, 218, 227,		192, 219, 228,		228, 246, 256,	
68G	442	602G	388	1605G	395	ABC-2	2	ABU-21	4	ABU-64P	346	AD-6	400		233, 246, 256,		228, 233, 246,		269, 271, 282,	
72G	442	603G	388	1606G	396	ABC-3D	2	ABU-21	346	ABU-65P	150	AD-7	400		267, 282, 299,		256, 268, 271,		294, 296, 301,	
73G	442	605G	388	1607G	396	ABC-5D	2	ABU-22D	4	ABU-65P	5	AD-8	400		318, 324, 325,		296, 299, 310,	AF-21P	347	
74G	391	607G	388	1610G	396	ABC-5I	2	ABU-23D	4	ABU-65P	346	AD-9	400		327, 332, 335,		317, 320, 325,		151, 159, 166,	
101-1G	402	608G	388	1611G	396	ABC-6	124	ABU-24D	4	ABU-66	124	AD-10	400	AF-6I	150, 156, 165, 179,		338, 341		184, 187, 189, 190,	
101-2G	402	609G	388	1613G	396	ABC-7	124	ABU-25D	4	ABU-67	3	AD-11	400		184, 185, 188, 192,	AF-9D	156, 165, 167,		190, 191, 193, 226,	
101G	446	610G	389	1615G	396	ABL-1	2	ABU-26D	4	ABU-67D	3	AD-12	400		218, 227, 233,		179, 184, 185,		228, 247, 256,	
126H-60G	402	611G	389	1616G	396	ABL-2	2	ABU-27	4	ABU-68	5	AD-13	400		246, 256, 267,		188, 192, 219,		269, 271, 282,	
126N-60G	402	612G	389	1617G	397	ABL-3	2	ABU-27D	4	ABU-69	3	AD-16	400		282, 299, 318,		227, 228, 233,		294, 296, 301,	
126PP-60G	402	614G	389	1619G	397	ABL-3D	2	ABU-28	4	ABU-70	5	AD-18	400		324, 325, 327,		246, 256, 267,	AG-1D	8	
200G	384	615G	389	1622G	397	ABL-4	2	ABU-29P	4	ABU-70D	5	AD-19	400		332, 335, 338, 341		271, 296, 299,	AG-1I	8	
201G	384	616G	389	1625G	397	ABL-5	3	ABU-30	4	ABU-71D	3	AD-21	400				310, 317, 319, 325,	AG-3D	8	
202G	384	618G	389					ABU-30D	4			AD-23	400				336, 338	AG-3I	8	
																			AG-4D	8

Índice de referencias  
Erreferentzia aurkibidea  
Index des références

Referenzverzeichnis  
Índice de referências  
Spis modeli

REF.	PAG.	REF.	PAG.	REF.	PAG.	REF.	PAG.	REF.	PAG.	REF.	PAG.	REF.	PAG.	REF.	PAG.	REF.	PAG.	REF.	PAG.
AG-4I	8	AGA-35G	452	ALF-10D	9	AMM-1	305	ARFE-1D	11	AS-A5	13	AS-LG7	14	ATA-1	10	AZ-17D	15	BAS-1D	159, 203, 204,
AG-5D	8	AGA-38	124	ALF-11D	9	AMM-1	314	ARFE-1I	11	AS-A7	13	AS-M5	13	ATA-1D	10	AZ-18	15		205, 207, 208,
AG-5I	8	AGA-39	124	ALF-12D	9	AMM-2	159, 224	ARFE-3D	11	AS-AK5	13	AS-M7	13	ATL-1	14	AZ-18D	15		209, 210, 212
AG-6D	8	AGA-40G	452	ALF-13D	9	AMM-2	314	ARN-1	11	AS-AK7	13	AS-MA7	14	ATR-1G	413	AZ-29	126	BAS-1I	159, 203, 204,
AG-6I	8	AGA-42	124	ALF-14D	9	ANA-1	11	ARN-2	11	AS-AL5	13	AS-MD7	14	ATR-2G	413	AZ-32	126		205, 207, 208,
AG-8D	8	AGA-43	124	ALF-15	9	ANA-1D	11	ARN-2D	11	AS-AL7	13	AS-ME5	14	ATR-2TG	413	AZ-37	15		209, 210, 212
AG-8I	8	AGA-44	124	ALF-16	9	ANC-1D	10	ARN-3	11	AS-AM5	13	AS-ME7	14	AU-1	163, 284, 288,	AZ-37D	15	BAS-2D	150, 17
AG-9D	8	AGA-46G	453	ALF-17	9	ANC-2	10	ARN-3D	11	AS-AM7	13	AS-MF7	14		289, 299, 309	AZ-37D	15	BAS-2I	150, 17
AG-9I	8	AGA-48	124	ALF-18	9	ANK-1	10	ARO-1D	11	AS-B5	13	AS-MG5	14	AU-AH	155, 163, 255, 268	AZ-37D	15	BAS-3	150, 17
AG-10D	8	AGA-48G	453	ALF-19	9	ANK-2	10	ARR-1	12	AS-B7	13	AS-MG7	14	AU-AHP	155, 163, 255, 268	AZ-39	126	BAS-4	306, 351
AG-10I	8	AGA-49	124	ALF-20	9	ANK-3	11	ARR-2	12	AS-BK5	13	AS-MM5	13	AU-AHP1	163	AZ-40	126	BAST-1I	17
AG-1I	8	AGA-49G	453	ALF-21	9	ANK-4	11	ARR-3	12	AS-BK7	13	AS-MM7	13	AU-AN	163, 164, 197, 255,	AZKO-1I	15	BAST-2D	17
AG-11D	8	AGA-50	124	ALF-22D	9	ANK-6	11	ARR-7D	12	AS-BL7	13	AS-N5	13		269, 284, 289,	B-3G	457	BAST-3D	17
AGA-1G	402	AGA-50G	453	ALF-23	9	ANK-17	11	ARR-8	12	AS-BM7	13	AS-N7	13		290, 298, 301,	B-3G(CV)	457	BAST-4DP	17
AGA-1I	7	AGA-51	8	ALF-24	9	ANK-47D	11	ARR-9D	12	AS-D7	13	AS-NN5	13	AU-ANP	163, 164, 197, 256,	BAB-1I	15	BAT-1D	126
AGA-1T	146	AGA-52	8	ALF-25	9	ANK-65	11	ARS-1D	12	AS-DD7	13	AS-NN7	13		269, 284, 289,	BAB-2I	15	BATU-1I	17
AGA-1T	146	AGA-55D	124	ALF-26	9	ANT-1G	412	AS-1	267, 291	AS-DK5	13	AS-P5	13		290, 298, 301,	BAB-3	15	BCZ-1	16
AGA-2G	443	AGA-57	8	ALF-27	9	ANT-2G	412	AS-1D	267, 291	AS-DK7	13	AS-P7	13		310, 313, 314	BAB-3D	15	BCZ-2	16
AGA-2T	146	AGB-1	8	ALF-28	9	ANT-3G	412	AS-1G	402	AS-DL5	13	AS-PA7	14	AU-C	163	BAB-4D	16	BD-1	15
AGA-2T	146	AGB-1D	8	ALF-29	9	ANT-4G	412	AS-2D	318, 346	AS-DL7	13	AS-PB7	14	AU-HV	163, 268, 284,	BAB-5	16	BDA-1	126
AGA-3G	443	AGB-2	125	ALF-30	9	ANT-5G	413	AS-2G	402	AS-DM5	13	AS-PF7	14		288, 289, 299,	BAB-5D	16	BE-1	17
AGA-3I	7	AGB-3	8	ALF-31	9	AP-1D	125	AS-2I	318, 346	AS-DM7	13	AS-PG7	14	AU-HVP	163, 268, 284,	BAB-6	16	BE-1G	413
AGA-4D	7	AGB-3D	8	ALF-32D	9	AP-2D	11	AS-3D	12	AS-E5	13	AS-PH7	14		288, 289, 299,	BAB-7	16	BE-3G	413
AGA-4G	446	AGB-4	125	ALF-33	9	AP-3D	125	AS-3G	402	AS-E7	13	AS-PN7	14		309	BAB-8D	16	BE-4D	17
AGA-4I	7	AGB-5	125	ALF-34	9	AP-4D	125	AS-3I	12	AS-EK5	13	AS-PP7	13			BAB-9D	16	BE-4G	413
AGA-5D	7	AGB-6	125	ALF-35	9	AP-5D	125	AS-4D	12	AS-EK7	13	AS-PR7	14	AU-HVP1	163	BAB-11	15	BE-4I	17
AGA-5G	443	AGB-7	125	ALF-36	9	AP-6D	125	AS-4G	413	AS-EL5	13	AS-PT7	14	AUM-2D	14	BAB-12D	15	BE-5D	17
AGA-5I	7	AGD-1	8	ALI-1	30	APEC-1G	447	AS-5D	12	AS-EL7	13	AS-R7	13	AU-W	164, 284, 288	BAB-13/1	15	BE-5G	414
AGA-6D	7	AGD-1X	302	ALP-1	9	APEC-2G	447	AS-5G	444	AS-EM5	13	AS-RA7	13	AV-1	14	BAB-13/10	15	BE-5I	17
AGA-6G	446	AGD-2	8	ALP-1D	9	AR-1D	12	AS-6D	12	AS-EM7	13	AS-RB7	13	AV-1D	14	BAB-13/11	15	BE-6G	414
AGA-6I	7	AGD-2X	302	ALP-2	9	AR-4DP	12	AS-6G-1	403	AS-F5	13	AS-RC7	13	AV-2D	14	BAB-13/12	15	BE-7G	414
AGA-7	7	AGE-1I	8	ALP-3	9	AR-4IP	12	AS-6G-2	403	AS-F7	13	AS-RD7	13	AX-1	14, 347	BAB-13/13	15	BE-10G	414
AGA-7G	447	AGE-2D	8	ALP-4D	9	ARC-1G	443	AS-7D	12	AS-FK5	13	AS-RE7	13	AX-1D	14, 347	BAB-13/2	15	BES-1D	17
AGA-8D	7	AGU-1D	9	ALP-5D	10	ARC-2G	443	AS-8D	12	AS-FK7	13	AS-RF7	13	AX-1DP	14, 347	BAB-13/3	15	BES-2D	17
AGA-8G	447	AHR-2	125	ALP-6	9	ARC-3G	443	AS-9D	12	AS-FL7	13	AS-RG7	13	AX-1P	14, 347	BAB-13/4	15	BES-3D	17
AGA-9G	447	AHR-3	125	ALP-6D	9	ARC-4G	443	AS-10D	12	AS-FM7	13	AS-RH7	13	AX-2P	126, 347	BAB-13/5	15	BES-4D	17
AGA-9I	7	AIZ-1	9	AMA-1	10	ARC-5G	443	AS-11D	12	AS-G5	13	AS-RK7	13	AX-2P1	126	BAB-13/6	15	BES-5D	17
AGA-10	7	AIZ-2D	9	AMA-1D	10	ARC-6G	443	AS-12D	12	AS-G7	13	AS-RN7	13	AX-3DP	14, 347	BAB-13/7	15	BES-6D	17
AGA-11	7	AKA-1PG	412	AMB-1	2	ARC-7G	443	AS-13D	12	AS-GG7	13	AS-RR7	13	AX-4DP	14, 347	BAB-13/8	15	BES-7D	17
AGA-12	124	AKS-1	291	AMB-1D	2	ARC-8G	443	AS-14D	12	AS-GK5	13	AS-S7	13	AX-5DP1	126	BAB-13/9	15	BES-8D	17
AGA-13I	7	AKS-1	313	AME-1	10	ARC-10G	443	AS-15D	12	AS-GK7	13	AS-SS7	13	AX-6	126	BAB-14D	16	BES-9D	17
AGA-14D	7	AL-1I	9	AME-2	10	ARC-11G	443	AS-16D	12	AS-GL5	13	AS-T5	13	AX-7P	126, 347	BAB-17D	16	BES-10D	17
AGA-15	7	AL-2	9	AME-4	10	ARC-12G	443	AS-17D	318	AS-GL7	13	AS-T7	13	AYP-1G	444	BAB-19	15	BES-11D	17
AGA-15G	452	AL-3	9	AMG-1	10	ARC-13G	443	AS-17D	347	AS-GM5	13	AS-TT7	14	AZ-1D	14	BAB-20D/2	15	BES-12D	17
AGA-15G	452	ALA-1X	302	AMG-2D	10	ARC-14G	444	AS-18D	12	AS-GM7	13	AS-U5	13	AZ-1I	14	BAG-1	126	BES-13D	17
AGA-16I	8	ALC-1D	9	AMG-3D	10	ARC-15G	444	AS-19D	342	AS-H7	13	AS-U7	13	AZ-2D	14	BAI-1D	16	BES-14D	17
AGA-18D	7	ALE-1	9	AMG-4D	10	ARC-16G	444	AS-19D	12	AS-HH7	14	AS-UU7	14	AZ-2I	14	BAI-5D	16	BES-15D	17
AGA-18I	7	ALE-1D	9	AMG-5D	10	ARC-17DP	11	AS-20D	12	AS-K7	13	AS-V5	13	AZ-3D	14	BAI-6	21	BES-16D	17
AGA-19D	7	ALE-1G	443	AMG-8D	125	ARC-17P	11	AS-21	318, 347	AS-KA7	14	AS-V7	13	AZ-3I	14	BAI-7	21	BES-17D	17
AGA-19I	7	ALF-1	9	AMG-9D	125	ARC-18PG	444	AS-21D	318, 347	AS-KD7	14	AS-VV7	14	AZ-4	15	BAI-8D	126	BEY-1D	127
AGA-20	8	ALF-2	9	AMG-10	125	ARC-19PG	444	AS-21DP	318, 347	AS-KE5	14	AS-W5	13	AZ-6	15	BAI-9D	126	BEY-2D	127
AGA-22	7	ALF-3	9	AMG-10D	125	ARC-20PG	444	AS-21P	318, 347	AS-KE7	14	AS-W7	13	AZ-7	15	BAI-12D	16	BH-1	157, 161, 228, 262,
AGA-23	7	ALF-4	9	AMG-11	125	ARC-21PG	444	AS-22	12	AS-KF7	14	AS-WW7	14	AZ-8D	126	BAI-13D	126		282, 306, 307,
AGA-23G	452	ALF-5	9	AMG-12D	125	ARC-22PG	444	AS-23	12	AS-KG7	14	AS-X7	13	AZ-9	126	BAN-1D	16		310, 351
AGA-24D	8	ALF-6	9	AMG-13D	10	ARC-23PG	444	AS-23D	12	AS-KK7	13	AS-XX7	14	AZ-9D	126	BAN-1I	16	BH-1P	157, 161, 228, 262,
AGA-24I	8	ALF-7	9	AMG-14D	125	ARC-24G	444	AS-24	291, 291	AS-L7	13	AS-Z7	13	AZ-10	15	BAN-2D	16		282, 306, 307,
AGA-25	124	ALF-8	9	AMG-15D	125	ARC-25G	444	AS-24D	267, 291	AS-LA7	14	ASC-1D	12	AZ-12	126	BAN-3D	16		310, 351
AGA-27G	452	ALF-8D	9	AMM-1	159, 224, 257	ARC-26G	444	AS-25D	12	AS-LD7	14	ASH-2	126	AZ-14	126	BAO-1	16	BH-2	299, 306, 312
AGA-29	124	ALF-9	9	AMM-1	303	ARC-27PG	444	AS-28	12	AS-LE7	14	ASI-1	12	AZ-17	15	BAO-1D	16	BH-3	350
		ALF-10	9	ARE-1D	11	AS-30D	13			AS-LF7	14	ASP-1D	12						

Índice de referencias  
Erreferentzia aurkibidea  
Index des références

Referenzverzeichnis  
Índice de referências  
Spis modeli

REF.	PAG.	REF.	PAG.	REF.	PAG.	REF.	PAG.	REF.	PAG.	REF.	PAG.	REF.	PAG.	REF.	PAG.	REF.	PAG.		
BH-4	180, 246, 273, 340	BK-17/5PZ	19	BK-19/15	19	BL-4D	150, 193, 196, 199, 200, 215, 236, 257, 284, 288, 290, 299, 307, 309, 313, 320	BON-3G	387	BRI-31	127	BUR-5	22	CA-7	25	CE-27D	27	CE-84	27
BH-5	350	BK-17/6	19	BK-19/16	19	BL-5D	150	BOX-1G	415	BRI-32D	21	BUR-5D	22	CA-7D	25	CE-28D	27	CE-85	27
BH-6	350	BK-17/6PZ	19	BK-19/19	19	BL-6	150, 193, 196, 199, 200, 215, 236, 257, 284, 288, 290, 299, 307, 309, 313, 320	BRA-1	77	BRI-33	127	BUR-5X	303	CA-8D	25	CE-29D	27	CE-86	27
BH-8	157, 351	BK-17/7	19	BK-19/20	19	BL-5	150	BRA-2	20	BRI-34	127	BUR-6	22, 150, 342	CA-8I	25	CE-30D	27	CE-87	27
BI-1D	17	BK-17/7PZ	19	BK-19/21	19	BL-5D	150	BRAS-1	20	BRN-1D	127	BUR-7	22	CA-9I	25	CE-31D	27	CE-88	27
BI-2	17	BK-17/8	19	BK-19/23	19	BL-6D	150, 193, 196, 199, 200, 215, 236, 257, 284, 288, 290, 299, 307, 309, 313, 320	BRI-1	403	BRN-2D	127	BUR-8D	22	CA-10I	25	CE-32D	27	CE-89	28
BI-3D	17	BK-17/8PZ	19	BK-19/25	19	BLT-1	16	BRI-1D	20	BRR-1	146	BUR-9	22	CA-11I	25	CE-33D	27	CE-89D	28
BI-E-1	17	BK-17/9	19	BK-19/26	19	BLU-1X	302	BRI-1I	20	BRR-1	146	BUR-9D	22	CA-12I	25	CE-34D	27	CE-90D	28
BIF-1	17, 1	BK-17/9PZ	19	BK-19/27	19	BLU-2X	302	BRI-1X	302	BRS-1	20	BUR-10	22	CA-13D	25	CE-35D	27	CE-91	27
BIL-1T	146	BK-17D/1PZ	19	BK-19/31	19	BM-1P	168	BRI-2	403	BRU-1	21	BUR-10D	22	CA-14D	25	CE-36D	27	CE-92	27
BIL-1T	146	BK-17D/2PZ	19	BK-19/32	19	BM-2	168	BRI-2D	20	BRU-1D	21	BUR-11D	23	CA-15I	26	CE-37D	27	CE-92D	27
BK-1D	18	BK-17D/3PZ	19	BK-20	19	BM-3	168	BRI-2I	20	BS-1I	159, 306, 350	BUR-12	23	CAB-1D	24	CE-38D	27	CE-93D	27
BK-1I	18	BK-17D/4PZ	19	BK-21/1	18	BM-2P	168	BRI-2X	302	BS-2	159, 315	BUR-13D	23	CAF-1G	415	CE-39D	27	CE-94	28
BK-2D	18	BK-18	19	BK-21/2	18	BM-3P	168	BRI-3	403	BS-4D	224, 297, 303, 315, 351	BUR-14	23	CAF-2G	415	CE-40D	27	CE-96	28
BK-3D	18	BK-18/1	19	BK-21/3	18	BM-4	168	BRI-3D	20	BS-5	159, 257, 315	BUR-14D	23	CAM-1D	150	CE-41D	27	CE-97	28
BK-4	18	BK-18/2	19	BK-21/4	18	BM-5P	168	BRI-3I	20	BS-6	224, 282, 297, 303, 315, 326, 351	BUR-15	23	CAS-1D	337	CE-42D	27	CE-98D	28
BK-4	350	BK-18/3	19	BK-21/5	18	BM-6P	168, 169	BRI-3X	302	BS-7	326, 350	BUR-16	23	CAT-1P	350	CE-43D	27	CE-99D	26
BK-4D	18	BK-18/4	19	BK-21/6	18	BM-6PIC1	169, 169	BRI-4D	20	BS-8	351	BUR-17	23	CAT-2	350	CE-44D	27	CE-100D	26
BK-4D	351	BK-18/5	19	BK-21/7	18	BM-B	168	BRI-4I	20	BS-8D	351	BUR-17D	23	CAT-3	350	CE-45D	27	CE-101D	26
BK-5D	18	BK-18/6	19	BK-21/8	18	BM-HB	169	BRI-6D	20	BS-9	351	BUR-18D	23	CAY-1D	26	CE-46D	27	CE-102	28
BK-5D	351	BK-18/7	19	BK-21/9	18	BM-HBP	169	BRI-6I	20	BS-9D	351	BUR-19D	23	CAY-1D WINDCOLOR	26	CE-47D	27	CE-103	28
BK-5I	18	BK-18/9	19	BK-21/10	18	BM-HBP1	320	BRI-6L1	403	BSS-1D	21	BUR-20D	23	CAY-1I	26	CE-48D	27	CE-104D	28
BK-5I	351	BK-18/10	19	BK-21/14	18	BM-NB	169	BRI-6L11	403	BSS-2	21	BUR-21D	23	CAY-2	127	CE-49	27	CE-105	28
BK-6D	18	BK-18/11	19	BK-21/16	18	BM-NBP	169	BRI-6L12	403	BSS-2D	21	BUR-22D	23	CCF-1X	303	CE-49D	27	CE-106	28
BK-6I	18	BK-18/12	19	BK-21/17	18	BM-W	169	BRI-6L17	403	BSS-3	21	BUR-23D	23	CCF-5X	303	CE-50	27	CE-107	28
BK-7D	18	BK-18/13	19	BK-21/19	18	BMB-1	20	BRI-6L18	403	BSS-4D	21	BUR-24	23	CCF-8X	303	CE-51	27	CE-108	26
BK-8D	18	BK-18/14	19	BK-22	18	BMB-2	20	BRI-6L2	403	BSS-5D	21	BUR-24D	23	CCF-9X	303	CE-51D	27	CE-109D	28
BK-9	18	BK-18/15	19	BK-23	18	BMB-3	20	BRI-6L21	403	BSS-6D	21	BUR-25D	23	CCF-10X	303	CE-52	27	CE-110	26
BK-9	18	BK-18/16	19	BK-26/125	18	BMB-3D	20	BRI-6L22	403	BTV-1D	21	BUR-26D	23	CE-1D	26	CE-53D	27	CE-111D	28
BK-14	18	BK-18/17	19	BK-26/135	18	BMB-4	20	BRI-6L29	403	BTV-1I	21	BUR-27D	22	CE-1I	26	CE-54	28	CE-114	127
BK-16	18	BK-18/18	19	BK-26/145	18	BMB-5	20	BRI-6L30	403	BTV-2D	21	BUR-28	23	CE-2D	26	CE-55	27	CE-117D	28
BK-16/0	18	BK-18/20	19	BK-26/235	18	BMC-1G	414	BRI-6L7	403	BTV-3	21	BUR-29	23	CE-2I	26	CE-56	27	CE-118D	27
BK-16/1	18	BK-18/21	19	BK-26/237	18	BOB-1	350	BRI-6L8	403	BU-1D	24	BUR-29D	23	CE-3D	26	CE-57	27	CE-130	28
BK-16/10	18	BK-18/22	19	BK-26/245	18	BOD-1	20	BRI-7D	20	BUL-1	127	BUR-31D	24	CE-3I	26	CE-58	28	CE-131D	28
BK-16/11	18	BK-18/23	19	BK-26/246	18	BOD-1G	414	BRI-8I	20	BUL-2D	22	BUR-32D	24	CE-4D	26	CE-59	28	CE-132/15	28
BK-16/13	18	BK-18/24	19	BK-27	18	BOD-2G	414	BRI-9D	20	BUL-3D	22	BUR-33	127	CE-5	27	CE-5D	27	CE-132/16	28
BK-16/14	18	BK-18/25	19	BK-28	18	BOD-3G	414	BRI-10	20	BUL-4D	22	BUR-34	24	CE-6D	27	CE-60	28	CE-132/17	28
BK-16/15	18	BK-18/26	19	BKY-1	127	BOD-4G	403	BRI-12	20	BUL-5D	22	BUR-35D	24	CE-6I	27	CE-61	28	CE-132/18	28
BK-16/16	18	BK-18/27	19	BKY-2	127	BOD-5G	403	BRI-13	20	BUL-6D	22	BUR-36	24	CE-7D	27	CE-62	28	CE-132/25	28
BK-16/17	18	BK-18/28	19	BL-1D	164, 284, 288, 289	BOG-1G	414	BRI-14	20	BUL-7D	22	BUR-36D	24	CE-7I	27	CE-63	28	CE-132/26	28
BK-16/18	18	BK-18/29	19	BL-1I	164, 284, 288, 289	BOG-2G	414	BRI-14D	20	BUR-1D	22	BUR-37D	23	CE-8D	27	CE-64	28	CE-132/27	28
BK-16/19	18	BK-18/30	19	BL-2	150, 193, 196, 199, 200, 215, 236, 257, 284, 288, 290, 299, 307, 309, 313, 320	BOM-1	20	BRI-15	20	BUR-1G	447	BUR-38	22	CE-9D	27	CE-65	28	CE-132/35	28
BK-16/2	18	BK-18/31	19	BL-3	150, 193, 196, 199, 200, 215, 236, 257, 284, 288, 290, 299, 307, 309, 313, 320	BOM-1D	20	BRI-16	127	BUR-1I	22	BUR-39	24	CE-10D	27	CE-66	28	CE-132/36	28
BK-16/20	18	BK-18/32	19	BL-4	150, 193, 196, 199, 200, 215, 236, 257, 284, 288, 290, 299, 307, 309, 313, 320	BOM-2	236	BRI-17	20	C	24	BUR-39D	24	CE-11D	27	CE-67	28	CE-132/37	28
BK-16/21	18	BK-18/33	19			BOM-2	314	BRI-18	21	C-2	25	BUR-40D	24	CE-12D	27	CE-68	28	CE-132/38	28
BK-16/23	18	BK-18/34	19			BOM-2	20	BRI-18D	21	C-3G	457	BUR-41	127	CE-13D	27	CE-69	28	CE-132/45	28
BK-16/3	18	BK-18/35	19			BOM-2D	236	BRI-19	21	C-3G(CV)	457	BUR-42D	24	CE-14D	27	CE-70	28	CE-132/46	28
BK-16/30	18	BK-19	19			BOM-2D	314	BRI-19D	21	CA-1I	25	BUR-43	127	CE-15D	27	CE-71	28	CE-134	29
BK-16/4	18	BK-19/1	19			BOM-2D	20	BRI-19 WINDCOLOR	21	CA-2I	25	BUS-1	24	CE-16D	27	CE-72	28	CE-136D/1	27
BK-16/5	18	BK-19/2	19			BOM-2D	236	BRI-20	20	CA-3I	25	C	24	CE-17D	27	CE-73	28	CE-136D/2	27
BK-16/7	18	BK-19/4	19			BOM-2D	314	BRI-21	20	CA-4D	25	C-2	25	CE-18D	27	CE-74	28	CE-136D/4	27
BK-16/9	18	BK-19/5	19			BOM-2D	236	BRI-22	21	CA-4I	25	C-3G	457	CE-19D	27	CE-75	28	CE-136D/5	27
BK-17/1	19	BK-19/6	19			BOM-2D	314	BRI-23	21	CA-5I	25	C-3G(CV)	457	CE-20D	27	CE-76	28	CEM-JC	178, 223, 265, 291
BK-17/1PZ	19	BK-19/7	19			BOM-2D	20	BRI-24	21	CA-6D	25	CA-1I	25	CE-21D	27	CE-77	27	CENT-1D	26
BK-17/2	19	BK-19/8	19			BOM-2D	20	BRI-25	127			CA-2I	25	CE-22D	27	CE-78	27	CENT-1I	26
BK-17/2PZ	19	BK-19/10	19			BOM-2D	236	BRI-26	127			CA-3I	25	CE-23D	27	CE-79	27	CENT-2D	26
BK-17/3	19	BK-19/11	19			BOM-2D	314	BRI-27	127			CA-4D	25	CE-24D	27	CE-80	27	CENT-2I	26
BK-17/4	19	BK-19/12	19			BOM-2D	236	BRI-28	127			CA-4I	25	CE-25D	27	CE-81	27	CENT-3D	26
BK-17/4PZ	19	BK-19/13	19			BOM-2D	314	BRI-29	127			CA-5I	25	CE-26D	27	CE-82	27	CENT-4	26
BK-17/5	19	BK-19/14	19			BOM-2D	20	BRI-30	127			CA-6D	25	CE-26D	27	CE-83	27	CER-1	26



Índice de referencias  
Erreferentzia aurkibidea  
Index des références

Referenzverzeichnis  
Índice de referências  
Spis modeli

REF.	PAG.	REF.	PAG.	REF.	PAG.
CER-1G	431	CHR-15	171, 255	CI-24	31
CER-2G	431	CHR-15P	171, 255	CI-25	128
CER-3G	431	CHR-17	180, 181, 240, 255	CI-26	128
CER-4G	431	CHTZ-1	29	CI-27	31
CF-1D	29	CHU-1D	29	CI-28D	31
CF-1I	29	CHU-1G	403	CI-29	31
CHA-2	29	CHU-2G	404	CI-30	128
CHA-2D	29	CHU-4G	416	CI-31	128
CHEK-1	29	CHU-5G	416	CI-32	128
CHI-1	29	CHU-10	29, 128	CI-33	128
CHI-1T	326	CI-1D	30	CI-34	31
CHI-1T	146	CI-1G	416	CI-34D	31
CHI-1T	146	CI-1I	30	CI-35	128
CHI-2	29	CI-1PG	416	CI-36	31
CHI-3	29	CI-2	31	CI-38D	31
CHI-4	29	CI-2G	416	CI-39D	30
CHI-5	29	CI-2I	31	CI-41	31
CHI-6	29	CI-3D	30	CI-42	31
CHI-7D	29	CI-3G	417	CI-43D	31
CHI-8D	29	CI-3PG	417	CI-44D	30
CHI-9D	29	CI-4D	30	CI-44D	347
CHI-10D	29	CI-4DP	30, 347	CI-45D	31
CHI-12D	29	CI-4G	417	CI-46D	31
CHR-1	170	CI-4I	30	CI-48	128
CHR-2	170	CI-4IP	30, 347	CI-48P	128
CHR-3	159, 172, 234, 249, 257, 260, 262, 276, 297, 308, 309, 311	CI-5DP	30	CI-49	31
CHR-3P	160, 172, 177, 249, 257, 262, 297, 309, 311	CI-5DP	347	CI-51	31
CHR-4D	170, 172, 249, 276	CI-5IP	30	CI-51D	31
CHR-4I	170, 172, 249, 276	CI-5IP	347	CI-53	31
CHR-5	308, 309	CI-5PG	417	CI-55D	31
CHR-6	150	CI-6D	30	CI-56	128
CHR-6D	150	CI-6G	417	CI-57	128
CHR-7	170, 180, 207, 254, 286	CI-6I	30	CI-58D	30
CHR-7P	170, 180, 207, 254, 286	CI-6PG	417	CI-59	128
CHR-8	170, 180, 207, 254, 286	CI-7D	30	CI-60	128
CHR-8P	170, 180, 207, 254, 286	CI-7TG	417	CI-61	31
CHR-9	160, 180, 224, 254	CI-8D	31	CI-62	31
CHR-9P	160, 180, 224, 254	CI-8G	417	CI-62D	31
CHR-10	160, 170, 180, 181, 224, 254	CI-9D	31	CI-63	31
CHR-10P	160, 171, 180, 181, 224, 254	CI-9PG	418	CI-63D	31
CHR-11P	284, 287	CI-10D	31	CI-64D	31
CHR-12	180, 254, 287	CI-10G	417	CI-65	31
CHR-13D	171, 180, 254, 287	CI-11D	31	CI-66D	31
CHR-14	160, 171, 180, 181, 202, 224, 254	CI-12	31	CI-67	128
CHR-14P	160, 171, 180, 181, 202, 225, 255	CI-12TG	417	CI-69	31
		CI-13	31	CI-70	31
		CI-13G	418	CI-71	128
		CI-14	128	CI-71P	128
		CI-15	31	CI-72	128
		CI-15D	31	CI-72P	128
		CI-16D	31	CI-73	128
		CI-17	128	CI-73P	128
		CI-18	31	CI-75P	128
		CI-19D	30	CI-76P	128
		CI-20	30	CI-77P	128
		CI-20D	30	CI-78P	128
		CI-21	128	CI-79P	128
		CI-22D	30	CI-80P	128
		CI-23D	30	CI-81	128
				CI-81P	128

REF.	PAG.	REF.	PAG.	REF.	PAG.
CI-82P	128	CLK-1	35	COR-27D	33
CI-83P	128	CLS-1D	32	COR-28	33
CI-84P	128	CLU-1D	350	COR-29D	34
CI-DL	31	CLU-1I	350	COR-30	34
CI-DL WINDCOLOR	31	CLU-2	350	COR-31	34
CI-IL	31	CLU-3	350	COR-32	34
CI-GDL	31	CLU-4	350	COR-33	34
CIF-1D	29	CLU-5	350	COR-34	34
CIF-1X	303	CMA-1	26	COR-35	34
CIF-2D	29	CMA-1D	26	COR-36D	32
CIF-3	29	CMA-2	26	COR-37	128
CIF-3D	29	CMA-2D	26	COR-3D	32
CIF-4	29	CML-1	24	COR-40	34
CIL-1	30	CN-1D	150	COR-48	32
CIL-1D	30	CN-1D	350	COR-49	32
CIL-2D	30	CNP-2D	24	COR-50-60	34
CIL-3D	30	CO-1D	35	COR-50-60I	34
CIL-4	30	COB-1P	347	COR-61	33
CIL-4D	30	COB-2	347	COR-62	34
CIL-5D	30	COH-1	32	COR-64	33
CIN-1	30	COH-2	32	COR-65	33
CIN-1D	30	COH-2D	32	COR-66	33
CIN-2	30	COH-3	32	COR-67	33
CIN-2D	30	COH-4	32	COR-68	33
CIS-1D	25	CO-M	35	COR-69	32
CIS-1I	25	COM-1D	32	COR-70	34
CIS-2	25	COR-1D	32	COR-70D	34
CIS-3	25	COR-1D WINDCOLOR	32	COR-71	33
CIS-4	25	COR-1GD	32	COR-72	33
CIS-5	25	COR-1I	32	COR-73	33
CIS-6D	25	COR-2D	32	COR-74	33
CIS-7D	25	COR-2I	32	COR-76D	32
CIS-803-1	453	COR-3	32	COR-77	128
CIS-803-2	453	COR-7	33	COR-78	34
CIS-803-3	453	COR-8	33	COR-79	32
CIS-803-4	453	COR-9	33	COR-80	32
CIS-803-5	453	COR-10	33	COR-114	34
CIS-803-6	453	COR-11	33	COR-115D	34
CIT-1C1	354, 356	COR-11D	33	COR-153	34
CL-1I	32	COR-12	33	COR-230	34
CL-2D	182, 320, 332, 334, 337, 338	COR-13	33	COR-231	35
CL-2I	182, 320, 332, 334, 337, 338	COR-13D	33	COR-232D	35
CL-3I	320, 332, 334, 337, 338	COR-15D	33	COT-1D	35
CL-4I	225	COR-16D	32	CR-1G	418
CL-6	268	COR-17D	33	CR-2G	418
CL-6P	268	COR-18D	32	CR-3G	419
CL-7P	157, 165, 171, 185, 192, 268, 293	COR-19D	32	CR-4G	419
CL-8P	173	COR-20	33	CR-5G	419
CL-9P	268	COR-20-25	33	CR-8G	419
CLA-1G	418	COR-20D	33	CR-11G	419
CLA-2G	418	COR-21D	32	CR-12G	419
CLA-3G	418	COR-223	34	CR-14G	419
CLA-4G	418	COR-22D	32	CR-17TG	419
CLF-1	31	COR-23D	33	CR-18G	419
CLI-1D	287	COR-24	33	CR-19G	420
		COR-24D	33	CRC-1X	303
		COR-25	33	CRF-1D	24
		COR-25I	33	CRN-1G	418
		COR-26	33	CRO-1G	447
				CRT-1G	415

REF.	PAG.	REF.	PAG.	REF.	PAG.
CRT-2G	415	DAD-3D	35	DAT-7P1	218, 243, 272, 304, 305, 309
CRT-3G	415	DAD-4D	35	DAT-8D	243, 273
CRT-4G	415	DAD-5D	35	DAT-8I	243, 273
CRT-7G	415	DAD-6D	35	DAT-8IP	243, 273
CRT-8G	415	DAE-1P	176	DAT-8IP1	243, 273
CRT-10G	444	DAE-2DP	176	DAT-8P	243, 273
CRT-11G	415	DAE-3D	176	DAT-9D	243, 273
CRT-12G	416	DAE-3DPI	176, 274	DAT-9DP	243, 273
CRT-13G	416	DAE-3DP2	170, 176, 205	DAT-9I	243, 273
CRT-14G	416	DAE-3P2	170, 176, 205	DAT-10	218, 243
CRT-15G	416	DAE-4D	176	DAT-10P	218, 243
CRT-17G	416	DAE-4DP1	176	DAT-11	234, 243, 273
CRT-18G	416	DAE-4P1	176	DAT-11P	234, 244, 273
CSB-1D	25	DAE-5P	170, 176	DAT-12	212, 244, 245, 246, 309
CSB-2D	25	DAF-1	36	DAT-12	309
CT-1	172, 299	DAF-1D	36	DAT-13	218, 244
CT-1P	172, 299	DAF-2	128	DAT-13P	218, 244
CT-2	172	DAF-3D	128	DAT-14	218, 244
CT-2P	172	DAF-4D	128	DAT-14P	218, 244
CT-2P1	172	DAI-1P	167, 177, 254	DAT-15	244, 273
CT-3	172, 233, 299	DAI-2D	178	DAT-15C1	356
CT-3P	172, 233, 299	DAL-01P	342	DAT-15C1	357
CT-4P	173	DAS-1D	128	DAT-15C2	356
CUB-1	35	DAT-1I	242, 245, 272	DAT-15C2	358
CVL-1D	35	DAT-1IP	242, 245, 272	DAT-15P	244
CVL-1I	35	DAT-1D	242, 245, 272	DAT-15P4	244
CVL-2D	35	DAT-1DP	242, 245, 272	DAT-16	170, 218, 244, 273
CVL-3D	35	DAT-2D	242, 245, 272	DAT-17	244
CVL-3I	35	DAT-2DP	242, 245, 272	DAT-17D	244
CVL-4	35	DAT-2I	242, 245, 272	DAT-18	244
CVL-5D	35	DAT-2IP	242, 245, 272	DAT-19	244
CVL-5D WINDCOLOR	35	DAT-3D	234, 242, 273	DAT-19P	244
CVL-5I	35	DAT-3D	242	DAT-20	244
CVL-5I WINDCOLOR	35	DAT-3I	234, 242, 273	DAT-20P	244
CVL-6	35	DAT-4D	234, 242, 273	DAT-6	157, 179, 182, 218, 243, 245, 272
CVL-8D	35	DAT-4I	234, 242, 273	DAT-6	304, 305, 309, 309
CVL-9D	128	DAT-5D	242	DAT-6C1	357
D-3G	457	DAT-6	157, 179, 182, 218, 243, 245, 272	DAT-6D	157, 179, 182, 218, 243, 245, 272, 304, 305, 309
D-3G(CV)	457	DAT-6	304, 305, 309, 309	DAT-6DP	157, 179, 182, 218, 243, 245, 272
DAC-1DP	175	DAT-6C1	357	DAT-6DP1	218, 243, 272
DAC-2D	175	DAT-6D	157, 179, 182, 218, 243, 245, 272, 304, 305, 309	DAT-6DP1	304, 305, 309, 304, 305, 309
DAC-3DC1	355	DAT-6DP	157, 179, 182, 218, 243, 245, 272	DAT-6P	157, 179, 183, 218, 243, 245, 246, 272, 309
DAC-4DC1	355	DAT-6P	157, 179, 183, 218, 243, 245, 246, 272, 309	DAT-6P1	218, 243, 272, 304, 305, 309
DAC-4DC1	357	DAT-6P1	218, 243, 272, 304, 305, 309	DAT-7	157, 179, 182, 218, 243, 245, 272, 304, 305, 309
DAC-4DC1	357	DAT-7	157, 179, 182, 218, 243, 245, 272, 304, 305, 309	DAT-7P	157, 179, 183, 218, 243, 245, 246, 272
DAC-4DP	176, 247, 262	DAT-7P	157, 179, 183, 218, 243, 245, 246, 272		
DAC-5C1	355				
DAC-5C1	356				
DAC-6DC1	355				
DAC-6DC1	357				
DAC-6DP	247, 262				
DAC-7DC1	355				
DAC-7DC1	357				
DAD-1D	35				
DAD-1I	35				
DAD-2D	35				
DAD-2I	35				

REF.	PAG.	REF.	PAG.	REF.	PAG.
DEK-13	36	DEK-16	129	DEK-17	129
DEK-14D	36	DEK-16	129	DEN-1	420
DEK-16	129	DEN-1	420	DIA-1	36
DEK-17	129	DIA-1	36	DIA-2	36
DIA-1	36	DIA-2	36	DIA-3	36
DIA-2	36	DIA-3	36	DIE-1	37
DIA-3	36	DIE-1	37	DIE-1	460
DIE-1	37	DIE-1	460	DLC-1	129
DIE-1	460	DLC-1	129	DLC-2	129
DLC-1	129	DLC-2	129	DLC-3	129
DLC-2	129	DLC-3	129	DLM-1D	36
DLC-3	129	DLM-1D	36	DLP-1	36
DLM-1D	36	DLP-1	36	DLP-2	36
DLP-1	36	DLP-2	36	DLT-1D	129
DLP-2	36	DLT-1D	129	DM-1	37
DLT-1D	129	DM-1	37	DMR-6-1	404





Índice de referencias  
Erreferentzia aurkibidea  
Index des références

Referenzverzeichnis  
Índice de referências  
Spis modeli

REF.	PAG.
FI-7I	186
FI-8I	166, 186, 188, 192, 268
FI-8IP	166, 186, 188, 192, 268
FI-8IP1	186, 193
FI-9I	158, 166, 186, 188, 193, 229, 246, 268, 271, 300
FI-9IP	158, 166, 187, 189, 193, 229, 246, 268, 271, 300
FI-10	165, 185, 188, 190, 228, 256, 271, 321, 325, 338
FI-10P	165, 185, 188, 190, 228, 256, 271, 299, 321, 325, 338
FI-11	166, 187, 189, 190, 193, 219, 229, 256, 271, 300, 317
FI-11P	166, 174, 187, 189, 190, 193, 219, 229, 257, 271, 300, 317
FI-12	158, 165, 173, 186, 191, 192, 249, 268, 293, 300
FI-12DP3	158, 166, 186, 173, 191, 192, 250
FI-12P	158, 173, 186, 219, 228, 268, 293
FI-12P1	158, 186, 191, 192, 300
FI-12P3	158, 166, 173, 186, 173, 191, 192, 228, 250, 300
FI-13	158, 187, 189, 191, 229
FI-13P	158, 187, 189, 191, 229
FI-13P1	158, 187, 187, 190, 229, 338
FI-13P7	158, 19
FI-14P	159, 187, 191, 229, 187
FI-15	187
FI-16C1	354, 355, 356
FI-16C3	354, 355, 356
FI-16P1	155, 159, 171, 173, 229
FIA-1	350
FIA-2	187
FIC-1	48
FIC-2	48
FIC-5	48
FIC-7	48
FIC-8	48
FIC-9	48
FIC-18	48
FIC-400	406
FIC-401G	406

REF.	PAG.
FIS-ID	48, 193, 300, 321
FLO-1	48
FLO-ID	48
FLO-2D	350
FLT-1	50
FLT-ID	50
FM-1G	425
FM-1X	304
FM-2G	425
FM-2X	304
FM-3G	425
FM-4G	425
FM-4TG	425
FM-5G	425
FM-6G	426
FM-7G	426
FM-8G	426
FM-13G	426
FM-14G	426
FM-15G	426
FM-16G	426
FM-17G	426
FM-20G	426
FM-21G	426
FO-1	196, 198, 199, 200, 231, 238
FO-2	196, 198, 199, 200, 231, 234, 238
FO-3	196, 199, 200, 231, 238
FO-3D	196, 199, 200, 231, 238
FO-3DP	196, 199
FO-3P	196, 199
FO-4P	193, 196, 199, 200, 201
FO-5	178, 223, 265, 291
FO-6P	193, 196, 199, 200, 201, 234
FO-7P	201, 238
FO-8	193, 201, 238
FO-8D	193, 201, 238, 244
FO-8DP	201, 238, 244
FO-8DP1	238, 245
FO-9D	193, 201
FO-9DP	194, 201
FO-9DP	194, 201
FO-10P	194
FO-11D	196, 201, 231, 238, 302
FO-12	198, 201
FO-12P	198, 201
FO-13DP	198, 201
FO-14DP	198, 201, 239
FO-15D	198, 201, 239, 302
FO-15DP	196, 198, 201, 239, 302

REF.	PAG.
FO-17P	196, 199
FO-18D	194
FO-20D	201, 231, 239, 302
FO-22P	194, 201
FO-24C1	355
FO-24C2	355
FO-24C3	355
FO-24C8	355
FO-24C9	355
FO-35	194
FO-36	194
FO-43D	194
FO-ANP	196
FO-D	198, 223, 239, 284
FO-E-TC	162, 194, 196, 199, 200, 202, 223, 239, 265, 294, 301
FO-E-TCP	162, 194, 197, 199, 200, 202, 223, 239, 265, 294, 302
FO-FHP	197
FO-FK	162, 166, 187, 189, 191, 194, 223, 225, 231, 256, 269, 281, 313
FO-FKP	162, 166, 187, 189, 191, 194, 223, 225, 231, 256, 269, 281, 313
FO-FR	162, 166, 178, 187, 189, 191, 194, 223, 225, 231, 256, 269, 281, 294, 313
FO-FRP	162, 166, 178, 187, 189, 191, 194, 223, 225, 231, 232, 256, 269, 281, 294, 313
FON-2E	48
FON-5E	48
FO-OA	183, 194, 246, 285, 288, 290, 297, 305, 307
FO-OL	183, 194, 246, 285, 288, 290, 297, 305, 307
FO-OR	183, 194, 246, 285, 288, 290, 297, 305, 307
FO-PN	183, 194, 246, 285, 288, 290, 297, 305, 307
FO-PRL	195, 198
FO-PRR	195, 198
FO-SR	195
FO-TC	177, 178, 195, 197, 198, 199, 202, 223, 239

REF.	PAG.
FO-TX	162, 195, 197, 198, 199, 200, 202, 302
FO-TX1	195, 197, 199, 200
FO-TX1P	195, 197, 199, 200
FO-TX2	195, 197, 199, 200
FO-TX2P	195, 197, 200
FO-TXP	162, 195, 197, 198, 200, 202, 302
FO-XL	195, 198, 239
FO-XR	195, 198
FORTIS-2I	49
FR-1D	49
FR-2	49
FR-4	49
FR-7D	49
FR-8	49
FR-9D	49
FR-11D	49
FRI-1X	304
FRI-2X	304
FTE-1	49
FTE-1D	49
FV-1D	47
FV-3	131
GAB-1D	50
GAB-1I	50
GAB-2	50
GARD-1G	427
GARD-2G	427
GAS-1	197, 253, 261, 287
GAS-1D	197, 253, 261, 287
GAT-1	51
GAT-2D	51
GAT-3D	51
GB-1D	54
GB-2D	54
GB-3D	132
GBZ-1	51
GD-1P	347
GD-1DP	347
GDA-1P	131
GDA-3D	52
GDA-4D	131
GDA-5	53
GDA-6D	53
GDA-7D	53
GDA-8D	53
GDA-30D	53
GDA-50D	53
GDA-60D	53
GE-1D	51
GE-2	51
GE-3D	51
GE-4D	51
GE-5	51
GE-5D	51
GE-6	51
GE-6D	51
GE-7	51

REF.	PAG.
GE-8	51
GE-9	51
GE-10D	52
GE-11	52
GE-15D	51
GE-16D	51
GE-19	51
GE-21	52
GE-21D	52
GE-22/1	51
GE-22/11	51
GE-22/12	51
GE-22/13	51
GE-22/15	51
GE-22/16	51
GE-22/17	51
GE-22/18	51
GE-22/19	51
GE-22/2	51
GE-22/3	51
GE-22/4	51
GE-22/5	51
GE-22/6	51
GE-22/7	51
GE-22/8	51
GEA-1	52
GEA-1X	304
GEA-2D	52
GEA-3	52
GEA-3X	304
GEA-4D	52
GEA-5D	52
GEA-6D	52
GEA-7D	52
GEA-8D	52
GEA-9/1	52
GEA-9/3	52
GEA-9/4	52
GEA-9/6	52
GEA-9/7	52
GEA-9/9	52
GEA-9/10	52
GEA-9/11	52
GEA-9/13	52
GEA-9/14	52
GEA-9D/12	52
GEA-9D/2	52
GEA-9D/5	52
GEA-9D/7	52
GEA-9D/8	52
GEB-1D	52
GER-2G	427
GER-3G	427
GER-4G	427
GER-5G	427
GEV-3D	131
GH-1	151
GH-2	151
GH-3	151

REF.	PAG.
GH-GX	351
GH-HX	351
GH-PS	151
GIB-ID	53
GIM-ITG	427
GIOB-1D	229
GIOB-1DP	229
GIOB-2I	229, 234
GIOB-2IP	229, 234
GIOB-3P2	159
GIU-1	53
GIU-ID	53
GIU-2	53
GIU-2D	53
GIU-3D	53
GIU-4	53
GLA-ID	53
GLA-2D	53
GLO-1D	53
GLO-1I	53
GLO-2	53
GLO-2D	53
GLO-3	53
GLO-3D	53
GLO-4D	53
GLO-4I	53
GLO-5I	54
GLO-6	54
GLO-6D	54
GLO-7	54
GLO-7D	54
GLO-8	54
GLO-8D	54
GLO-9D	54
GLO-10	54
GLO-11	54
GLO-12D	54
GLO-22	54
GLO-22D	54
GLO-23D	54
GM-1P	167, 205, 221
GM-2	205, 208, 212, 221
GM-2P	205, 208, 212, 222
GM-3P	203, 204, 205, 209
GM-4	222, 247
GM-4P	222, 247
GM-4P1	222, 247
GM-5	155, 208, 222, 304
GM-5P	155, 208, 214, 222, 304
GM-6	160, 203, 204, 205, 207, 209, 210, 212, 220, 221, 247

REF.	PAG.
GM-6P	160, 203, 204, 205, 207, 209, 210, 212, 220, 221, 248
GM-7	160, 203, 204, 205, 207, 209, 210, 212, 221, 247
GM-7P	160, 203, 204, 205, 207, 209, 210, 212, 221, 248
GM-8	160, 203, 204, 205, 207, 209, 210, 212, 221, 247
GM-8P	160, 203, 204, 205, 207, 209, 210, 212, 221, 248
GM-9	160, 203, 204, 205, 207, 209, 210, 212, 225, 221, 247
GM-9P	160, 203, 204, 205, 207, 209, 210, 212, 225, 221, 248
GM-10	203, 204, 205, 207, 209, 211, 212, 220, 232
GM-10P	203, 204, 205, 207, 209, 211, 212, 220, 232
GM-11	203, 204, 205, 207, 209, 211, 212, 220, 232
GM-11P	203, 204, 205, 207, 209, 211, 212, 220, 232
GM-12P	203, 204, 205, 207, 209, 211, 212, 220, 232
GM-13	203, 204, 205, 207, 209, 211, 212, 220, 232
GM-13P	203, 204, 205, 207, 209, 211, 212, 220, 232
GM-14	203, 205, 210, 211, 314
GM-14P	202, 203, 205, 210, 211, 314
GM-15D	222
GM-15DP	222
GM-16P	204, 206
GM-17P	204, 206
GM-18P	204, 206
GM-19P	203, 206, 210, 211
GM-20P	203, 206, 210, 211
GM-21	212
GM-21P	212
GM-22	203, 206, 210, 211

REF.	PAG.
GM-22P	203, 206, 210, 211
GM-23	203, 206, 210, 211
GM-23P	203, 206, 210, 211
GM-24	208
GM-24P	208
GM-25	203, 206, 210, 211, 314
GM-25P	202, 203, 206, 210, 211, 314
GM-26	203, 204, 206, 209
GM-42	212
GM-A	160, 204, 206, 207, 209, 210, 211, 212, 220, 221, 225, 248
GM-AP	160, 204, 206, 207, 209, 210, 211, 213, 220, 221, 225, 248
GM-B	204, 205, 206, 207, 209, 210, 211, 213, 221, 232
GM-BP	204, 205, 206, 207, 209, 210, 211, 213, 221, 232
GM-C	160, 204, 206, 207, 209, 210, 211, 212, 221, 225, 248
GM-CP	160, 204, 206, 207, 209, 210, 211, 213, 221, 225, 248
GM-D	204, 205, 206, 207, 209, 210, 211, 213, 232
GM-DP	204, 205, 206, 207, 209, 210, 211, 213, 232
GM-E	160, 204, 206, 207, 209, 210, 211, 212, 221, 225, 248
GM-EP	160, 204, 206, 207, 209, 210, 211, 213, 221, 225, 248
GM-H	204, 205, 206, 207, 209, 210, 211, 213, 232
GM-HP	204, 205, 206, 207, 209, 210, 211, 213, 232
GM-J	160, 204, 206, 207, 209, 210, 211, 212, 221, 225, 248
GM-JP	160, 204, 206, 207, 209, 210, 211, 213, 221, 225, 248

REF.	PAG.
GM-K	204, 205, 206, 207, 209, 210, 211, 213, 232
GM-KP	204, 205, 206, 207, 209, 210, 211, 213, 232
GMG-1G	428
GMG-2G	428
GMT-1	51
GMT-2	51
GMT-3D	51
GMT-4D	51
GMT-5D	51
GMT-7D	51
GMT-8D	51
GOD-1	132
GOD-2	132
GOD-3	54
GOD-4	54
GPS-1G	427
GPS-2G	427
GPZ-1G	406
GR-1D	55
GR-1I	55
GR-2D	55
GR-2I	55
GR-3D	55
GR-3I	55
GR-4D	55
GR-4I	55
GR-5D	55
GR-5I	55
GR-6	55
GR-6D	55
GR-7	55
GR-7D	55
GR-8	55
GRG-1	54
GTV-1D	55
GTV-2	55
GTV-2D	55
GTV-3D	55
GTV-4D	55
GTV-5D	55
GTV-1	

Índice de referencias  
Erreferentzia aurkibidea  
Index des références

Referenzverzeichnis  
Índice de referências  
Spis modeli

REF.	PAG.	REF.	PAG.	REF.	PAG.	REF.	PAG.
HOND-3I	327	HOND-43D	328	HUD-3	57	IF-7	58
HOND-4D	327	HOND-43DP	328	HUD-3D	57	IF-8	132
HOND-4DP	327	HOND-43P	328	HUN-1D	57	IF-9	132
HOND-4DP1	327	HOND-45D	329	HUW-1	57	IF-10D	58
HOND-4DP2	327	HOND-46D	329	HUW-2	58	IF-15	58
HOND-4I	327, 331	HOND-49	329	HUW-3D	132	IF-35	59
HOND-4IP	327, 331	HOR-1	57	HUW-N	58	IF-45/55	59
HOND-4IP1	327	HOR-2	57	HY-1	215	IF-60/70	59
HOND-5D	327	HOR-2D	57	HY-2	215	IF-D20	58
HOND-5I	327	HRM-1	57	HY-2P	215	IF-D25	59
HOND-6D	327	HT-1	57	HY-3	215, 24	IF-D30	59
HOND-6I	327	HTE-1D	57	HY-3D	215, 24	IF-I20	58
HOND-7D	327	HTE-50	132	HY-3DP	215	IF-I25	59
HOND-7I	327	HU-1	162, 184	HY-3DP1	216, 24	IF-I30	59
HOND-8D	327	HU-2P	313	HY-3DP2	216, 27	IF-I40	59
HOND-8I	327	HU-4CI	354, 357, 358	HY-3P2	216, 27	IF-I40L	59
HOND-9D	327	HU-7C1	354, 357, 358	HY-3P3	270	IF-I50	59
HOND-9I	327	HU-AN	285, 288, 290	HY-4	216	IF-I51	59
HOND-10	155, 214, 265	HU-DF	291	HY-4P	216	IF-I60/70	59
HOND-10P	155, 214, 265	HU-DFP	291	HY-4P2	216	IGS-1	59
HOND-11	155, 214, 265	HU-DHP	291	HY-4P3	216	IL-1D	61
HOND-11P	155, 214, 265	HU-DNP	291	HY-5	216, 27	IL-1I	61
HOND-12	214	HU-HAAC1	354, 357, 358	HY-5P	216, 27	IL-2	61
HOND-12P	214	HU-HAAC2	354, 357, 358	HY-6D	216	ILC-1D	61
HOND-13	214	HU-HAAC3	354, 358	HY-6DP	216	ILC-2D	61
HOND-13P	214	HU-HAAC4	358	HY-7P	216	ILC-3	61
HOND-14	214	HU-HAAC5	358	HY-8	216	ILC-6D	61
HOND-14P	214	HU-HAAP1	285	HY-8P	216	ILL-1	61
HOND-15	156, 215	HU-HCAP	173, 25	HY-9P2	216	ILL-2	61
HOND-15P	156, 215	HU-MN	307	HY-10	216	ILL-2D	61
HOND-16D	156, 215	HU-MNP	307	HY-11DP1	217, 226	ILS-1	61
HOND-16DP	156, 215	HU-NAAC2	354, 357, 358	HY-11DP3	217, 218, 226	IMB-1	61
HOND-17P	156	HU-NW	151	HY-11P3	217, 218, 226	IMB-1D	61
HOND-18DP	327	HU-P	151	HY-11P4C1	217	IMS-10	274
HOND-19	328	HU-SC	169, 177, 195, 248, 255, 271, 285, 291, 307, 313	HY-12P3	226	IMS-11P	275
HOND-19D	328			HY-18PIC1	226	IMS-12	187, 190, 193, 247, 269
HOND-19DP	328			HY-19DP5	217	IMS-13	151, 159, 166, 180, 183, 184, 187, 189, 190, 191, 193, 226, 228, 234, 247, 256, 269, 271, 282, 294, 296
HOND-19P	328	HU-SR	169, 177, 195, 248, 255, 271, 285, 291, 307, 313	HY-19P5	217		
HOND-20	328			HY-20P	217		
HOND-20D	328			I-1G	457		
HOND-20DP	328	HU-SU	169, 177, 195, 248, 255, 271, 285, 291, 307, 313	I-1G NIQ	457		
HOND-20P	328			IB-1	58		
HOND-22D	328			IB-2	58		
HOND-23	328	HU-SX	169, 177, 195, 248, 255, 271, 285, 291, 307, 313	ICA-1	58	IMS-13	323, 324, 331, 334, 335
HOND-24DP	328			ICA-4IP	58		
HOND-24P	328			ICA-5IP	58	IMS-13	347
HOND-25P2	327	HU-SY	169, 177, 195, 248, 255, 271, 285, 291, 307, 313	ICS-1D	58	IMS-13P	151, 159, 183, 184, 187, 189, 190, 191, 193, 226, 228, 247, 256, 269, 271, 282, 294
HOND-26DP1	328			ICS-2D	58		
HOND-26P1	328	HU-SZ	169, 177, 195, 248, 255, 271, 285, 291, 307, 313	IDM-1G	428		
HOND-27D	328			IDM-2G	428		
HOND-28DP	328			IDM-3G	428	IMS-13P	301
HOND-28P	328	HUD-1	213, 221, 225, 233, 291, 297, 298, 303, 315, 351	IDM-4G	428	IMS-13P	323, 324, 331, 334, 335
HOND-29DP	328			IDM-5G	428		
HOND-29P	328			IDM-5G	428	IMS-13P	348
HOND-30DP2	327	HUD-1D	213, 221, 225, 233, 291, 297, 298, 303, 315, 351	IF-1I	58	IMS-19	323, 324, 331, 334, 335
HOND-30P2	327			IF-2	132		
HOND-31P	328			IF-3P	58	IMS-19P	323, 324, 331, 334, 335
HOND-42P	328			IF-4	132		
HOND-43	328	HUD-2	57	IF-5	58	IMS-21	323, 324, 331, 334, 335
				IF-6	132		

REF.	PAG.	REF.	PAG.
IMS-21P	323, 324, 331, 334, 335	IMS-7	230, 269, 274
IMS-3	151, 159, 166, 180, 183, 184, 187, 189, 190, 191, 193, 226, 228, 234, 246, 256, 269, 271, 282, 294, 296, 301, 309, 323, 324, 331, 334, 335, 347	IMS-7P	230, 269, 274
IMS-3P	151, 159, 166, 180, 183, 184, 187, 189, 190, 191, 193, 226, 228, 234, 247, 256, 269, 271, 282, 294, 296, 301, 309, 323, 324, 331, 334, 335, 348	IN-1	162, 169, 223, 230, 239, 265, 291, 348
IMS-5	151, 159, 166, 180, 183, 184, 187, 189, 190, 191, 193, 226, 228, 234, 246, 256, 269, 271, 282, 294, 296, 301, 309, 323, 324, 331, 334, 335, 347	IN-4	162, 169, 223, 230, 239, 265, 291, 348
IMS-5P	151, 159, 166, 180, 183, 184, 187, 189, 190, 191, 193, 226, 228, 234, 247, 256, 269, 271, 282, 294, 296, 301, 309, 323, 324, 331, 334, 335, 348	IN-5	162, 169, 223, 230, 239, 265, 291, 348
IMS-7	230, 269, 274	INCE-1E	146
IMS-7P	230, 269, 274	INCE-2E	146
IN-1	162, 169, 223, 230, 239, 265, 291, 348	ING-6	61
IN-4	162, 169, 223, 230, 239, 265, 291, 348	ING-A	61
IN-5	162, 169, 223, 230, 239, 265, 291, 348	ING-D	61
		ING-M	61
		ING-N	61
		ING-S	61
		ING-W	61
		INH-ID	132
		INT-1	61
		INT-ID	61
		IR-IP	132
		IS-ID	62

REF.	PAG.	REF.	PAG.
IS-1G	428	JAR-2D	62
IS-1I	62	JAR-2I	62
IS-1X	305	JAR-3	62
IS-2D	62	JAR-4D	63
IS-2I	62	JAR-5D	63
IS-3D	62	JAR-5I	63
IS-3D WINDCOLOR	62	JAR-6	62
IS-3G	428	JAR-6D	62
IS-3I	62	JAU-1P	178, 223
IS-4	62	JD-1	351
IS-4G	429	JD-2	324, 351
IS-5D	62	JD-3	351
IS-5G	429	JD-4D	351
IS-6D	132	JF-ID	133
IS-6G	429	JGH-1D	64
IS-7D	62	JIN-ID	63
IS-8	62	JIP-ID	63
IS-8D	62	JIP-1I	63
IS-10	133	JIS-ID	63
IS-10P	133	JIS-2I	63
IS-14D	133	JIS-3D	63
IS-15	62	JIS-3I	63
IS-16D	62	JIS-4P	63
IS-17D	62	JMA-1D	112
IS-18D	62	JMA-1I	112
IS-19D	62	JMA-2D	112
IS-20	133	JMA-2I	112
IS-21D	62	JMA-3D	112
IS-22D/1	133	JMA-3I	112
IS-22D/2	133	JMA-4D	112
IS-22D/3	133	JMA-4I	112
IS-22D/4	133	JMA-9D	112
IS-22D/5	133	JMA-9I	112
IS-23DP	133	JNG-1	64
IS-24DP	133	JNG-1D	64
ISU-1	305	JNG-2D	64
ISU-2	304	JNG-3	64
ISU-2	305	JO-1	63
ISU-3D	222	JOM-1D	63
ISU-3DP	222	JP-1	407
ISU-3DP1	222	JP-2	407
ISU-5	62	JP-3	407
IT-1G	429	JP-4	407
IT-1TG	429	JP-5	407
IT-2G	429	JP-6	407
IT-3G	429	JPM-1D	64
IT-4G	429	JPM-1E	64
ITO-ID	62	JPM-1I	64
ITO-2D	133	JPM-2D	64
ITO-3D	133	JPM-2E	64
IV-1	62	JPM-2I	64
IV-2D	62	JPM-3D	64
IV-3D	62	JPM-4	64
J-1G(CV)	458	JPM-4D	64
J-2G(CV)	458	JPM-10D	64
J-3G	458	JPM-11D	64
J-3G(CV)	458	JTF-1I	64
JAR-ID	62	JTF-2I	64
JAR-1I	62	JTF-3	64

REF.	PAG.	REF.	PAG.
JTF-4	64	KAE-3	65
JU-1	64	KAE-3D	65
JU-2	65	KAE-4	134
JU-2D	65	KAE-5	65
JUNI-2	64	KAE-6	65
JUNI-1	64	KAE-6D	65
JUNI-ID	64	KAE-7	65
JUNI-2D	64	KAE-7D	65
JUNI-3D	64	KAE-8	65
JUNI-4D	64	KAE-8D	65
JUNI-5D	64	KAE-9	65
JUNI-6D	64	KAE-9D	65
JUNI-7D	64	KAE-10D	134
JUNI-8D	64	KAE-11D	134
JUNI-9D	64	KAE-12D	134
JUZU-1	65	KAE-13D	65
JV-ID	65	KAE-14	134
JV-1I	65	KAE-15D	134
JV-2	65	KAL-1	65
JV-3D	65	KAL-2D	65
JV-3I	65	KAM-1	151
JV-4I	65	KAM-1D	151
JV-5I	65	KAP-1D	65
JV-6	65	KAP-2D	65
JV-7	65	KAS-1G	430
JV-7D	65	KAS-2G	430
JW-20G	429	KAS-4G	430
JW-30G	429	KAS-6G	430
JW-40G	430	KAW-1D	329
JW-45G	430	KAW-1I	329
JW-50G	430	KAW-2D	329
JW-70G	430	KAW-2I	329
JW-90G	430	KAW-3	330
JWL-ID	63	KAW-4	217
JWL-2D	63	KAW-4	330
JWL-3D	63	KAW-5	330
JWL-4D	63	KAW-5P	330
JWL-5	63	KAW-6DP	321, 323, 330
JWL-6	63	KAW-6P	321, 323
JWL-7D	63	KAW-7P	330
JWL-9	63	KAW-8D	330
JWL-9D	63	KAW-9P	330
JWL-10D	64	KAW-10P	330
JWL-11D	64	KAZ-1	65
KA-1	133	KAZ-2	65
KA-2	133	KAZ-3	65
KA-3	133	KAZ-4	66
KA-4	133	KAZ-5	66
KA-5	133	KAZ-5D	66
KA-6	134	KAZ-6	66
KA-7	133	KAZ-7	66
KA-7 WINDCOLOR	134	KE-1	134
KA-8	134	KE-3	134
KA-10	134	KE-4	134
KA-11	134	KE-5	135
KAB-ID	65	KE-6	135
KAE-1	134	KE-7	135
KAE-1G	430	KEN-1	66, 221, 225, 226, 233, 348, 351
KAE-2	134		

REF.	PAG.	REF.	PAG.
KEN-ID	66, 221, 225, 226, 233, 348, 351	KFV-1	66
		KFV-1X	304
		KFV-2	66
		KFV-2X	304
		KFV-3X	305
		KFV-C	66
		KFV-D	66
		KFV-E	66
		KFV-F	66
		KFV-L	66
		KFV-M	66
		KFV-N	66
		KFV-O	66
		KI-ID	198, 226
		KI-IDP	198, 226
		KI-IDP1	226
		KI-2D	226
		KI-3DP	226
		KI-3P	226
		KI-11P	226
		KI-12DP	226
		KI-12P	226
		KIC-1	66
		KIF-1	66
		KIF-1D	66
		KIF-2D	66
		KIR-ID	66
		KIR-2	66



Índice de referencias  
Erreferentzia aurkibidea  
Index des références

Referenzverzeichnis  
Índice de referências  
Spis modeli

REF.	PAG.	REF.	PAG.	REF.	PAG.	REF.	PAG.	REF.	PAG.	REF.	PAG.	REF.	PAG.	REF.	PAG.	REF.	PAG.		
KRCFO-16	361, 364	LAP-1	67	LAS-AX	151	LF-9	265, 296	LF-WB	281	LIT-3D	70	MAS-2D	74	MAZ-13D	236	ME-2P	237	MER-8I	77
KRCFO-24	361, 362, 364	LAP-2D	67	LAS-AX-L	69	LF-10	72	LF-WBP	281	LIT-5D	70	MAS-3D	75	MAZ-13DP	236	ME-3P	237	MER-9I	77
KRCFO-30D	362, 362, 364	LAP-2E	67	LAS-BT	276	LF-11D	72	LF-WR	178, 195, 223, 303	LIT-5I	70	MAS-4D	75	MAZ-13DP1	236	ME-4P	237	MER-10I	77
KRCGM-27	360, 365, 366	LAP-3	407	LAS-CR	276	LF-12	319, 339			LIT-7D	70	MAS-5D	75	MAZ-14D	236	ME-5P	237	MER-11I	77
KRCGM-28	360, 365	LAP-3D	67	LAS-FH	348	LF-12	72	LIN-1D	69	LMP-1	183, 250, 257	MAS-6	75	MAZ-14D	303	ME-6P	237	MER-12I	77
KRCGM-37	360, 362, 366	LAP-3E	67	LAS-KT	68, 348	LF-12D	319, 339	LIN-1I	69	LMP-1P	183, 250, 257	MAS-7	75	MAZ-15D	236	ME-7P	237	MER-13I	77
KRCGM-43	366	LAP-3I	67	LAS-P	173	LF-13	72	LIN-2	69	LMP-2	250, 250, 257	MAS-7D	75	MAZ-16	236	ME-8P	237	MER-14I	77
KRCHOND-21	362	LAP-4	135	LAS-R	69, 173, 250, 262, 297, 302, 306, 311, 312, 314, 342	LF-13D	72	LIN-2G	431	LMP-2P	250, 257	MAS-8	75	MAZ-21DP1	236	ME-9P	307	MER-15	78
KRCHOND-31	360, 362	LAP-5D	67			LF-14D	72	LIN-3D	69	LMP-3	250, 258, 276	MAS-9	75	MAZ-21DP1	80	ME-10P	237	MER-16	78, 321
KRCHU-HAA	360, 365, 366, 367	LAP-6	67	LAS-RC	276	LF-15	72	LIN-3G	431	LMP-3P	311	MAS-9D	75	MBL-1D	80	ME-11P	237	MER-16D	78, 321
KRCHU-HCA	361, 363, 365, 367	LAP-7D	67	LAS-SX	69	LF-15D	348	LIN-3I	69	LMP-3P	250, 276	MAS-10	75	MBL-1G	408	ME-12P	237	MER-17	78
KRCHY-4	362, 363	LAP-8D	135	LAS-TB	276	LF-16	72	LIN-4D	69	LMP-4	250, 258, 276	MAS-10D	75	MCH-1	78	ME-13DP	308	MER-18	78
KRCHY-6D	362	LAP-9	67	LAS-TK	68, 348	LF-17	72	LIN-4I	69	LMP-4	311	MAS-11	75	MCH-1D	78	ME-14P	308	MER-19D	78
KRCHY-11	362, 363	LAP-9D	67	LAS-TX	69	LF-17	72	LIN-5D	69	LMP-4P	250, 276	MAS-11D	75	MCH-2	78	ME-HD	237, 271	MER-20D	78
KRCHY-11D	363	LAP-10D	135	LAS-UY	69	LF-17	348	LIN-5I	69	LMP-4P1	258	MAS-12D	75	MCH-2D	78	ME-HDP	237, 272	MER-21D	78
KRCISU-3D	361, 362, 363	LAP-11D	135	LAS-U	68, 151, 335, 348	LF-18D	72	LIN-6D	69	LMP-4P1	311	MAS-13D	75	MCL-1D	76	ME-HDP	308	MER-22D	78
KRCKI-7	362, 363	LAP-13P	135	LAS-V	69, 173, 250, 262, 297, 302, 306, 311, 312, 314, 342	LF-19	72	LIN-6I	69	LMP-5	250, 258, 262, 276	MAS-15P	136	MCM-1	76	ME-HF	237, 271	MER-1D	151, 351
KRCMAZ-11D	364	LAP-17P	135			LF-20	73	LIN-7D	69	LMP-5	311	MAS-17	75	MCM-1G	408	ME-HFP	237, 272	MER-1DP	151, 351
KRCME-7	367	LAP-20P	135	LAS-X	151, 335, 348	LF-20D	73	LIN-7I	69	LMP-5P	250, 276	MAS-17D	75	MCM-2D	76	ME-HM	237, 271	MER-1DPI	152
KRCMIT-8D	364, 365	LAP-21P	135	LAS-XY	69	LF-21	73	LIN-8D	69	LMP-5P1	258, 262	MAS-18D	75	MCM-2G	431	ME-HMLP	237	MER-1P1	152
KRCMIT-12	364	LAP-22P	135	LAS-Y	69, 173, 250, 262, 297, 302, 306, 311, 312, 314, 342	LF-22	73	LIN-8I	69	LMP-5P1	311	MAS-19	75	MCM-2I	76	ME-HMLP	308	MER-2DP	151, 351
KRCMIT-18	365	LAP-23P	135			LF-23	73	LIN-9	69	LO-1D	71	MAS-22D	74	MCM-3D	76	ME-HMP	237, 272	MET-2D	78
KRCNE-36	366	LAP-28D	67	LASB-1	69	LF-24	73	LIN-10D	70	LO-1I	71	MAS-24D	74	MCM-3G	431	ME-HMP	308	MEZ-1D	78
KRCOP-11	360, 361, 362, 365	LAP-29D	67	LASB-1D	69	LF-25	73	LIN-10I	70	LO-2D	72	MAS-29D	75	MCM-3I	76	ME-HU	238	MG-6D	32
KRCOP-S	362, 365	LAP-30D	67	LASB-1D	69	LF-26	73	LIN-11D	70	LO-2I	72	MAS-42	136	MCM-4D	76	ME-HUP	238	MG-6I	32
KRCSUB-2	366	LAP-34D	67	LASB-1G	408	LF-27	73	LIN-11I	70	LO-3D	71	MASL-1	136	MCM-4EC	76	ME-HY	238	MG-6S	32
KRCSUZU-14	366	LAP-42D	67	LASB-2	69	LF-28	73	LIN-12D	69	LO-4D	72	MAU-1	136	MCM-4G	408	ME-HYP	238	MG-9	32
KRCTOYO-15	367	LAP-43D	67	LASB-2D	69	LF-29D	73	LIN-12I	69	LOC-1D	71	MAU-2	136	MCM-4I	76	ME-HZ	237, 271	MGA-1	78
KRCTOYO-18	363	LAP-44D	67	LASB-2D	69	LF-30	73	LIN-13	135	LPO-1	68	MAU-3D	75	MCM-4SS	136	ME-HZP	237	MGA-1D	78
KRCTOYO-30	363	LAP-45D	67	LASB-2G	408	LF-31	73	LIN-14D	69	LPO-2	68	MAU-4D	75	MCM-5D	76	ME-HZP	272	MGA-2	136
KRE-ID	67	LAP-46D	67	LASB-3D	69	LF-32	195	LIN-14I	69	LT-1	135	MAU-5D	75	MCM-5G	432	ME-HZP	308	MGA-3	136
KRP-1G	431	LAP-53	68	LASB-3G	408	LF-32	72	LIN-15D	69	LUC-1D	74	MAX-1G	448	MCM-5I	76	ME-L	238	MH-1	137
KUB-ID	351	LAP-57	68	LASB-4G	408	LF-32	348	LIN-15I	69	LUC-2	74	MAX-2G	448	MCM-6	76	ME-L	308	MH-2D	137
KUB-2D	351	LAP-71	68	LB-1	71	LF-33D	73	LIN-16	70	LUMA-1D	74, 348	MAZ-1D	234	MCM-7	76	ME-NU	238	MI-ID	78
KUR-1G	431	LAP-88	68	LB-1D	71	LF-34	73	LIN-16D	70	LUMA-1I	74, 348	MAZ-1D	303	MCM-8	76	ME-NUP	238	MI-2D	79
KWI-1	67	LAP-93	68	LB-2D	71	LF-35	73	LIN-17	69	LUMA-2D	74, 348	MAZ-1I	234	MCM-10	136	ME-NY	238	MI-3D	79
KWI-1K	67	LAP-96D	68	LB-2DP	71	LF-36	73	LIN-17D	69	LUMA-2I	74, 348	MAZ-1I	303	MCM-11S	136	ME-NYP	238	MI-4D	79
KWI-2D	67	LAP-98	68	LB-2MD	71	LF-37D	74	LIN-18	69	LUMA-3D	74, 348	MAZ-2D	199, 234	MCM-12D	76	ME-S	302, 308	MI-5D	79
KYM-1DP	331	LAP-100	408	LB-3	71	LF-38D	74	LIN-18D	69	LUMA-3I	74, 348	MAZ-2DP	199, 235	MCM-13D	76	ME-SP	302	MIL-1	79
KYM-1P	331	LAR-1G	408	LB-3D	71	LF-40	73	LIN-19D	135	LUMA-4D	74, 348	MAZ-2I	199, 234	MCM-15E8	136	ME-VA	212, 238, 314	MIL-1	460
KYM-2	331	LAR-1I	68	LB-4D	71	LF-41	74	LIN-20D	69	LUMA-4I	74, 348	MAZ-2IP	199, 235	MCM-16E8	136	MEC-5D	77	MIL-2	79
KYM-2D	331	LAR-2G	444	LB-5D	71	LF-43	73	LIN-21D	135	LWO-1	71	MAZ-3D	235	MCM-18D	76	MEC-6	77	MIL-2	460
KYM-2DP	331	LAR-3G	445	LB-6D	71	LF-44	74	LIN-21D WINDCOLOR	135	LWO-1D	71	MAZ-3DP	235	MCM-21D	136	MED-1D	77	MIIN-1D	79
KYM-2P	331	LAS-1D	68, 151	LCK-1X	306	LF-45	74	LIN-25	70	LWO-2	71	MAZ-3I	235	MCM-24B	76	MED-2D	77	MIS-1	79
KYM-3DP	331	LAS-2	68, 348	LEA-1D	69	LF-46	74	LIN-25D	70	LWO-2D	71	MAZ-3IP	235	MCM-24C	76	MEG-1D	136	MIT-ID	171, 181, 213, 222, 240, 303, 305, 350, 351
KYM-3P	331	LAS-3	151, 335, 348	LEA-2D	69	LF-47	72	LIN-25D WINDCOLOR	70	LWO-7D	71	MAZ-4	235	MCM-24D	76	MEL-1	77	MIT-IDP	171, 213, 240, 303, 305, 350, 351
L-3G	458	LAS-4	348	LEG-1D	69	LF-47	348	LIN-26D	135	LWO-8	71	MAZ-4P	235	MCM-24E	76	MEL-2D	77	MIT-IIP	171, 213, 222, 240, 303, 305, 350, 351
L-3G(CV)	458	LAS-4D	68	LF-1	72	LF-50D	74	LIP-1D	70	LWO-9	71	MAZ-5D	235	MCM-24F	76	MEL-3	77	MIT-2D	171, 206, 217, 222, 240, 275, 278, 304, 308, 350, 351
LA-1D	227	LAS-4D	68	LF-1D	72, 348	LF-51	74	LIP-1GD	70	LWO-9D	71	MAZ-5DP	235	MCM-26	76	MEL-4	77		
LA-1DP	227	LAS-5	151, 335, 348	LF-1I	348	LF-BL	164, 220, 265	LIP-1GD	70	LWO-26D	71	MAZ-6	202, 235	MCM-27	136	MEL-4D	77		
LA-2	227	LAS-5D	151, 335, 348	LF-2	72, 319, 339	LF-RO	164, 169, 220, 230, 232, 234, 247, 265, 282, 296, 301	LIP-1I	70	LYF-2T	146	MAZ-6D	202	MCM-29D	76	MEL-5P	77		
LA-2P	227	LAS-6	68, 348	LF-3	72			LIP-2	70	MA-5D	74	MAZ-6DP	202, 235	MCM-30D	77	MER-1D	77		
LA-3D	227, 241	LAS-6D	68, 348	LF-4I	72			LIP-2D	70	MAC-1G	448	MAZ-6P	202, 235	MCM-31	77	MER-1T	146		
LA-3DP	227, 242	LAS-7	68	LF-5	72, 195, 348			LIP-3	70	MAF-1	408	MAZ-7D	235	MCM-31D	77	MER-2I	77		
LA-4D	227	LAS-8	68	LF-5D	195, 348			LIP-3	70	MAG-2DP	135	MAZ-7DP	235	MCM-32D	77	MER-3I	77		
LA-4DP	227	LAS-9	68	LF-6	171, 181, 282, 296, 302			LIP-28D	70	MAK-1	306	MAZ-7DP1	235	MCM-33	77	MER-3T	146		
LAF-1D	67	LAS-10	68	LF-7	72			LIP-33	70	MAR-1P	233	MAZ-8D	235	MCM-35	77	MER-4I	77		
		LAS-11	68	LF-7D	72			LIP-4	70	MAS-1	74	MAZ-8DP	235	MCM-45	136	MER-5I	77		
		LAS-11D	68	LF-8D	72			LIT-1I	74	MAS-1D	74	MAZ-11D	235	ME-1	236	MER-6I	77		
		LAS-12D	68					LIT-2D	70			MAZ-11DP1	236	ME-1P	237	MER-7I	77		



Índice de referencias  
Erreferentzia aurkibidea  
Index des références

Referenzverzeichnis  
Índice de referências  
Spis modeli

REF.	PAG.
MIT-2DP	171, 217, 222, 240, 278, 304, 308, 350, 351
MIT-2I	171, 206, 217, 222, 240, 275, 278, 304, 308, 350, 351
MIT-2IP	171, 217, 222, 240, 278, 304, 308, 350, 351
MIT-3	240, 248
MIT-3P	240, 248
MIT-4	241
MIT-4P	241
MIT-5	241
MIT-5P	241
MIT-6	241
MIT-6P	241
MIT-7	167, 180, 181, 241
MIT-7P	167, 180, 182, 241, 305
MIT-8D	172, 181, 182, 241
MIT-8DP	172, 181, 182, 241
MIT-8DP2	241
MIT-9	308
MIT-10	308
MIT-11D	308
MIT-12	167, 181, 182, 241
MIT-13D	181, 182, 241, 255
MIT-14D	181, 182, 241, 255
MIT-15P	167, 180, 182, 241, 305
MIW-1	79
MIW-2	79
MIW-3	79
MIW-4	79
MLM-1D	79
MLM-2	79
MLM-3	79
MLM-4	137
MLM-5	79
MLM-5D	79
MLM-6	80
MLM-7	80
MLM-8	137
MLM-9	79
MM-1X	307
MNO-1D	80
MOD-1DP	152
MOG-1D	80
MOI-1G	432
MOI-2G	432
MOI-3G	432
MOI-4G	432, 448
MOI-5G	432, 448
MOK-1G	409
MON-1D	80
MON-1I	80
MON-2D	80
MON-2I	80

REF.	PAG.
MOR-1X	307
MOR-2X	307
MOS-1	242
MP-1D	80
MP-1I	80
MPA-1G	409
MQ-1D	74, 348
MQ-1I	74, 348
MQ-2	74, 93
MQ-3	136
MQ-4D	74
MR-1	80
MR-2	80
MR-3	80
MSM-1D	137
MSM-2D	80
MSV-1	81
MSV-1X	307
MSV-2	81
MT-1G	432
MT-1P	137
MT-2D	137
MT-2DP	137
MT-2G	432
MT-2TG	433
MT-3G	433
MT-3PIG	433
MT-3PG	433
MT-4G	433
MT-5G	433
MT-5PIG	433
MT-6G	433
MT-6PIG	433
MT-6PG	434
MT-8G	434
MT-8PIG	434
MT-8PG	434
MT-9G	434
MT-9PIG	434
MT-9PG	434
MT-10G	433
MT-10PIG	433
MT-10PG	434
MT-11G	434
MT-14G	434
MT-15G	434
MT-16G	434
MT-17PIG	434
MT-17PG	435
MT-18G	435
MT-AG	80
MT-AGP	80
MT-CG	80
MT-CGP	80
MT-DGP	80
MT-EG	80
MT-EGP	80
MT-GG	80
MT-GGP	80
MTL-1	78

REF.	PAG.
MTL-1D	78
MTL-1G	432
MTL-2G	432
MTO-1	78
MU-2P1	137
MU-3P1	137
MU-4P1	137
MU-5P1	137
MU-6	81
MU-6D	81
MU-7P1	137
MU-8P1	137
MU-9P1	137
MU-10P	137
MU-11P1	137
MU-16P	137
MUE-1	460
MUE-2	460
MXS-1	75
MXS-3D	75
N-1G	457
N-1G NIQ	457
NAB-1X	307
NE-1	152, 164, 215, 239, 265, 296, 301, 314, 351
NE-1D	152, 164, 215, 239, 265, 296, 301, 351
NE-1DIP	152, 164, 215, 239, 265, 296, 301, 351
NE-1P	152, 164, 215, 239, 265, 296, 301, 314, 351
NE-2	152
NE-3	183, 187, 189, 227, 242, 253, 258, 261, 276, 283, 294, 297, 311, 314
NE-3D	183, 187, 189, 227, 242, 253, 258, 261, 276, 283, 294, 197, 311, 314
NE-3P	183, 188, 189, 227, 242, 253, 261, 283, 295, 297, 311, 314
NE-3P1	183, 227, 242, 258, 276, 295, 298, 311
NE-3P2	183, 188, 189, 227, 242, 253, 258, 261, 276, 283, 295, 298, 311, 314
NE-4	155, 162, 173, 189, 250, 253, 258, 261, 263
NE-4D	155, 162, 173, 189, 250, 253, 258, 261, 263

REF.	PAG.
NE-4P	155, 174, 190, 250, 253, 258, 261, 263
NE-4P1	162, 174, 251, 258, 261, 263
NE-4P2	174, 251, 258, 261, 263
NE-5	258
NE-6	310, 317, 319, 320, 322, 323, 324, 325, 326, 329, 330, 331, 332, 334, 335, 336, 337, 339, 341, 342
NE-6P	310, 317, 319, 320, 322, 323, 324, 325, 326, 329, 330, 331, 332, 334, 335, 336, 337, 339, 341, 342
NE-7	320
NE-8	317, 318, 319, 321, 322, 323, 324, 325, 329, 326, 332, 333, 334, 335, 336, 337, 338, 339, 340, 343
NE-9	291, 314
NE-9P	291, 314
NE-10	179, 239, 292, 296
NE-10P	179, 239, 292, 296
NE-11	195, 230, 245, 265, 270, 298, 303, 305, 312
NE-11P	196, 230, 245, 265, 270, 298, 303, 305, 312
NE-11P1	230, 266
NE-11P2	230, 266
NE-11P3	302, 303
NE-12	292, 314
NE-12P	292, 314
NE-13	159, 292
NE-14	266
NE-15D	155, 162, 173, 189, 250, 253, 258, 261, 263
NE-15DP	155, 174, 190, 250, 253, 258
NE-15DP1	162, 174, 251, 258, 261, 263
NE-15I	155, 162, 173, 189, 250, 253, 258, 261, 263
NE-15IP	155, 174, 190, 250, 253, 258

REF.	PAG.
NE-15IP1	162, 174, 251, 258, 261, 263
NE-16	160, 258, 261
NE-18	292
NE-18P	292
NE-19	160, 182, 251, 259, 263, 311
NE-19P	160, 182, 259, 263, 311
NE-19P1	160, 259, 263
NE-20	251, 253
NE-20P	161, 251, 259, 263
NE-20P1	161, 251, 254, 259, 263
NE-20P2	161, 251, 259, 263
NE-20P3	161, 174, 259, 263
NE-22P	161, 259, 261, 263, 298, 309, 311
NE-22P1	161, 174, 251, 310
NE-22P2	161, 236, 276, 298
NE-23	236
NE-24	196, 230, 266, 270
NE-24P	196, 230, 266, 270
NE-24P1	230, 266
NE-25	159, 185, 313
NE-26	236
NE-27	152
NE-28	182, 259, 261, 263, 311
NE-29	251
NE-29P	251
NE-30	152, 348
NE-30P	152, 348
NE-31	152, 348
NE-31P	152, 348
NE-32	152, 348, 346
NE-32P	152, 346
NE-33P	152, 276
NE-33P1	276
NE-34P	251
NE-35	215, 266
NE-35P	266
NE-35P2	215, 266
NE-36	161, 174, 251, 259, 261, 263
NE-36P	161, 174, 251, 259, 264
NE-36P1	161, 174, 251, 259, 261, 264
NE-37	252
NE-37P	252
NE-38	259
NE-38P1	259
NE-39P	161, 174, 252, 259, 264
NE-40	292
NE-40P	292
NE-41P	292
NE-42	254

REF.	PAG.
NE-42P	254
NE-42P1	254
NE-43	254, 262
NE-44P	152, 276
NE-45	337
NE-45P	337
NE-46	190
NE-47	188
NE-48	152
NE-49	152
NE-50P	260
NE-51P2	252
NE-52P	231, 266
NE-53	190, 254, 262
NE-54P	153
NE-55P	260, 262
NE-56	292, 331
NE-57	153
NE-58D	272, 352
NE-59P	161, 260, 262
NE-60C1	356, 358
NE-60C2	356, 357
NE-60C3	356, 357
NE-61D	238
NE-62	238
NE-63D	153
NEF-1X	307
NEF-2Z1	453
NEF-2Z2	453
NEF-2Z3	453
NEF-2Z4	453
NEF-2Z5	453
NEF-2Z6	453
NEF-2Z7	453
NEF-2Z8	453
NEF-2Z9	453
NEF-2Z10	453
NEF-3	81
NEF-4	81
NO-1	137
NOX-1	81
NTC-6	81
NTC-10D	81
OA-1	82
OCA-1D	81
OCA-2D	81
OF-1	81
OF-2	81
OJ-1D	81
OJ-2I	81
OJ-3D	81
OJ-3I	81
OJ-4D	81
OJ-5I	82
OJ-6D	82
OJ-6I	82
OJ-7I	81
OJ-9D	82
OJ-10	82

REF.	PAG.
OJ-11	82
OJ-12	82
OJ-13	82
OJ-14	82
OJ-15	82
OJ-16	82
OJ-17	82
OJ-18P	82
OJ-19	82
OJ-20/4	137
OJ-21D	82
OJ-J	82
OJ-K	82
OJ-L	82
OJ-M	82
OJ-Q	137
OL-5D	82
OLIV-1	82
OM-1	83
OMC-1D	82
OMC-1G	435
OMC-2D	83
OMC-3	137
OMC-4	137
OMC-5D	83
OMC-6D	83
OMC-7	137
OMI-1	83
OMI-1D	83
ON-1D	83
ON-1I	83
OP-1	153
OP-6	176, 248
OP-7	176, 248
OP-8	176, 248
OP-9	176, 248
OP-11C1	354, 355, 356
OP-11C3	356
OP-AB	176, 213, 248, 282
OP-ABP	177, 213, 248, 283
OP-BA	176, 213, 248, 282
OP-BAP	177, 213, 248, 283
OP-BB	153, 170, 177, 248
OP-CC	153, 170, 177, 248
OP-D	177, 207, 212, 213, 232, 248, 283
OP-DD	153, 170, 177, 248
OP-DP	177, 202, 208, 212, 213, 232, 248, 283
OP-EE	153, 170, 177, 248
OP-FF	153, 170, 177, 248
OP-HA	170, 248
OP-HB	170, 248
OP-HG	249
OP-HH	249
OP-J	177, 213, 249, 283
OP-JP	177, 213, 249, 283
OP-NA	170, 248
OP-NB	170, 248

REF.	PAG.
OP-R	208, 221, 249, 283
OP-RP	208, 221, 249, 283
OP-S	177, 207, 212, 213, 232, 248, 283
OP-SP	177, 202, 208, 212, 213, 232, 248, 283
OP-SP1	249
OP-T	208, 221, 249, 283
OP-TP	208, 221, 249, 283
OP-WHCl	354, 356
OP-WHP	162, 202, 208, 213, 221, 249, 283
OP-WYP	162, 202, 208, 213, 221, 249, 283
OR-0G	445
OR-1G	445
OR-1I	83
OR-2G	435
OR-3G	409
OR-4G	445
OR-5G	445
OR-6G	409
ORK-1D	83
ORO-1D	83
OST-1G	409
OST-2G	409
PAD-1D	83
PAD-2D	83
PAD-3	83
PAD-3D	83
PAP-1	83
PAP-1X	307
PAP-2	83
PAP-2X	307
PAP-3	83
PAP-4	84
PAP-5	84
PAP-6	84
PAP-7	84
PAT-1G	435
PC-1D	84
PC-1T	147
PC-2D	84
PC-3TP	147
PC-4	84
PCI-1T	147
PEN-1	84
PEN-1D	84
PEN-2	84
PET-1	84
PEU-1C1	355, 356
PEU-2C1	357
PFA-1	84
PFA-2	84
PFA-3	84

REF.	PAG.
PFA-4	84
PFA-5	84
PFA-6	85
PFA-6D	85
PFA-7D	85
PFA-8D	85
PFA-9D	85
PFA-10D	84
PFA-11D	84
PFA-12D	84
PFA-13D	84
PFA-14D	84
PFA-15D	84
PFA-16D	84
PFA-17D	84
PFA-18D	84
PFA-21	85
PFA-22	84
PFA-22D	84
PFA-23D	84
PFA-24	85
PFA-24D	85
PFA-25	85
PFA-25D	85
PFA-26D	85
PFA-27D	85
PGO-1	338

Índice de referencias  
Erreferentzia aurkibidea  
Index des références

Referenzverzeichnis  
Índice de referências  
Spis modeli

REF.	PAG.	REF.	PAG.	REF.	PAG.	REF.	PAG.	REF.	PAG.	REF.	PAG.	REF.	PAG.	REF.	PAG.	REF.	PAG.	REF.	PAG.
RE-4D	86	RO-7I	87	RO-46	88	RUS-2	89	SEL-4D	91	SKO-1	269	SPI-1D	138	STS-2D	183	SUZU-10P	213, 223, 275	TD-30	131
RE-5	86	RO-8D	87	ROD-1	87	SA-1	90	SEN-1D	91	SKO-2	269	SQ-1	94	STS-2DP	184	SUZU-11D	340	TD-31	50
RE-5D	86	RO-8I	87	ROD-1D	87	SA-1D	90	SEN-2D	91	SKO-3I	270	SQ-2	94	STS-3D	95	SUZU-11DP	340	TE-1D	97
RE-6	86	RO-9D	87	ROS-2	309	SA-2	90	SER-1G	449	SKO-3IP	270	SQ-3D	94	STS-3I	95	SUZU-12DP	330, 34	TE-1G	410
RE-6D	86	RO-9I	87	ROS-2	310	SA-3D	90	SER-3D	138	SKO-4	270	SQ-4	94	STS-4D	95	SUZU-12P	330, 34	TE-1I	97
REG-1D	86	RO-10D	87	ROSE-1	138	SA-3I	90	SH-1I	92	SKO-5P	270	SQ-5D	94	STS-4DP	95	SUZU-13DP	319, 321, 329, 330, 332, 336, 338, 340	TE-2G	410
REN-1G	409	RO-10I	87	ROY-1	88	SA-4	90	SHA-1	92	SKO-6	270	SQ-6	94	STS-5D	183			TE-3	97
REN-2G	409	RO-11D	87, 252, 260	RSS-1	89	SA-5D	90	SHI-1	92	SKO-7	270	SQ-7	94	STS-5DP	184			TE-3G	410
REVI-1G	437	RO-11I	87, 252, 260	RSS-2D	89	SAA-1PI	267	SHI-1D	92	SKO-8	270	SQ-8D	94	STS-6D	96	SUZU-13P	319, 321, 329, 330, 332, 336, 338, 340	TE-4	97
REX-1D	86	RO-12D	87	RSS-3	89	SAA-2P	267	SHI-2D	92	SL-1	91	SR-1I	96	STS-7D	96			TE-7D	97
REX-1G	409	RO-12I	87	RSS-3D	89	SAA-AC	267	SHI-3D	92	SLG-1	90	SR-2	96	STS-1I	339			TE-8D	97
REX-2G	410	RO-14	252	RST-1	20	SAA-ACP	267	SHR-1	90	SLG-2	90	SR-3	96	STS-12D	96	SUZU-14P2	275	TE-8DKT1	97
RGL-1G	437	RO-15	155, 162, 260, 264	RU-1	88	SABT-1	89	SI-1D	153	SLG-3	91	SR-4	96	STS-13D	96	SUZU-21P	275	TE-8I	97
RGM-1D	86			RU-1D	88	SAF-1G	438	SI-2D	153, 188, 190	SLG-4	91	SRM-1G	439	STS-21D	96	SUZU-21P	340	TE-8I	97
RGM-1I	86	RO-15	312	RU-1D	88	SAF-2G	438	SI-3	153, 188, 190	SLG-5	91	SSA-1P1	270	STS-28	95	SWL-1	92	TE-8I	97
RGM-2	86	RO-16D	87	WINDCOLOR		SAG-IT	147	SI-3D	153, 188, 190	SLG-6	91	SSO-1	93	STS-35	138	TAI-1	96	WINDCOLOR	
RI-1D	87	RO-16I	87	RU-2D	88	SAG-IT	147	SI-4	153	SLG-7	91	SSO-2	93	STS-38	138	TAL-1D	96	TE-9D	98
RI-1I	87	RO-17	264	RU-2I	88	SAM-1D	89	SI-4D	153	SLG-8	91	ST-1I	95	STS-B1	139	TAL-2	97	TE-10I	98
RI-2D	87	RO-17	312	RU-3D	88	SAM-1G	438	SIA-2G	439	SLG-9	91	ST-2	95	STS-T14	139	TAL-3	97	TE-11D	98
RI-2I	87	RO-18I	87	RU-4D	88	SAM-2D	90	SIA-3G	439	SLG-10	91	STA-1	94	STS-T15	139	TAP-1P	154	TE-23	98
RI-3D	87	RO-19D	87	RU-5D	89	SAM-2G	438	SIB-1G	449	SLG-11	91	STA-1D	94	STS-TV3	139	TAP-2	154	TE-28	98
RI-3I	87	RO-19I	87	RU-5I	89	SAM-4G	438	SIB-2G	439	SLG-12	91	STA-2	94	STS-TV5	139	TAT-1D	277	TE-T10	139
RIG-1D	86	RO-20D	87	RU-6I	89	SAM-5G	438	SIB-3G	439	SLG-13	91	STA-2D	94	STS-TV8	139	TAT-1D	277	TE-T10D	139
RIO-1D	86	RO-20I	87	RU-7D	89	SAM-5G	438	SIB-4G	439	SLG-14	91	STA-3	94	STS-TV9	139	TAT-IDP	277	TE-T11	139
RIT-1D	87	RO-21D	87	RU-8D	89	SAR-1	90	SIB-5G	439	SLG-15	91	STA-3D	94	STS-X5	139	TAT-2DP	233, 277	TE-T12PLUS	139
RO-1D	87, 175, 252, 260, 264, 277, 298, 306, 307, 312	RO-21I	87	RU-9D	89	SAR-1D	90	SID-1	92	SLG-16	91	STA-4	94	STS-X6	139, 349	TAY-1	97	TE-T60	139
		RO-22I	87	RU-9I	89	SAR-2D	90	SID-2	92	SLG-17	91	STA-4D	94	STUV-1D	96	TC-1	139	TE-T60	139
RO-1DS	170, 172, 249, 257, 276	RO-23D	87	RU-10D	88	SAR-3D	90	SIM-1200	153	SLG-18	91	STA-5	94	STUV-1I	96	TC-2	97	WINDCOLOR	
		RO-24D	88	RU-11D	89	SAR-4	90	SIP-1	247, 294, 301	SLG-19	91	STA-5D	94	STUV-2	96	TC-3	139	TE-T62	139
RO-1I	87, 175, 252, 260, 264, 277, 298, 306, 307, 312	RO-24I	88	RU-12D	89	SAR-4D	90	SIP-2	188, 192, 256	SLG-20	91	STB-2	96	STUV-3	96	TCH-1DP	97	TE-T80	140
		RO-25D	88	RU-13D	89	SAR-5D	90	SIP-3	159, 166, 188, 190, 230, 269, 334	SLG-21	91	STB-2D	96	SUB-2P	273	TCH-1P	97	TE-T80EH	140
RO-1IS	170, 172, 249, 257, 276	RO-25I	88	RU-14D	89	SAR-6	90	SIS-1	92	SLG-22	91	STE-1	95	SUZU-1D	275	TD-1	49	TE-T80SC	140
		RO-26D	88	RU-15	89	SAR-6D	90	SIS-2	92	SLG-23	91	STE-2D	95	SUZU-1I	275	TD-1D	49	TE-T82	140
RO-1X	307	RO-26I	88	RU-16D	89	SAR-6D	90	SIS-3	92	SLG-24	91	STE-3	95	SUZU-1I	275	TD-2	49	TEC-1G	439
RO-2D	87, 175, 264, 277, 298, 306, 307, 312	RO-27D	88	RU-19D	88	SAT-1D	90	SIS-4D	92	SLG-25	91	STE-4	95	SUZU-2D	275	TD-2	49	TEC-2	139
		RO-28D	88	RU-19D	88	SAT-2	90	SIS-5D	92	SM-1	92	STE-5D	95	SUZU-2D	275	TD-3	49	TEI-1D	97
RO-2I	87, 175, 264, 277, 298, 306, 307, 312	RO-28I	88	RU-GC	89	SAT-2	90	SIS-6	92	SM-2	92	STE-6	95	SUZU-2I	275	TD-4	49	TEM-D35	97
		RO-29D	88	RU-GK	89	SCC-1D	91	SIS-6D	92	SM-3	92	STE-7	95	SUZU-3I	340	TD-5	49	TEM-D55	97
RO-3	170, 172, 249, 276, 276	RO-29I	88	RU-GK7	89	SCH-1D	91	SIS-7D	92	SM-3D	92	STE-8D	95	SUZU-4D	319, 321, 329, 330, 332, 336, 337, 340	TD-6	49	TEM-I35	97
		WINDCOLOR		RU-GL	89	SCO-1	15	SIS-8D	92	SM-4	92	STE-9D	95			TD-7	131	TEM-I55	97
RO-4D	87, 175, 252, 264, 277, 298, 306, 307, 312, 314	RO-30	87	RU-GL7	89	SCR-1	138	SIS-9	92	SM-4D	92	STE-10	95	SUZU-4D	319, 321, 329, 330, 332, 336, 338, 340	TD-8	49	TEU-1	352
		RO-30D	87	RU-GM	89	SE-AHP	269	SIS-9D	92	SOF-1	93	STE-11	95	SUZU-4I	319, 321, 329, 330, 332, 336, 337, 340	TD-8D	49	TH-1	98
RO-4I	87, 175, 252, 264, 277, 298, 306, 307, 312, 314	RO-31D	88	RU-GM7	89	SEA-1	138	SIX-1	175, 252	SOF-2	93	STE-12	95	SUZU-4I	319, 321, 329, 330, 332, 336, 337, 340	TD-9	49	TI-1	98
		RO-32D	87	RU-GS	89	SEA-2	138	SIX-1P	175	SOFI-1D	93	STE-13D	95			TD-10	49	TI-15	98
RO-5D	87, 153, 175, 234, 252	RO-33	87	RU-GS7	89	SEC-1	138	SIX-1P1	175, 252	SOFI-1I	93	STE-14D	95	SUZU-4IP	319, 321, 329, 330, 332, 336, 338, 340	TD-11D	50	TIF-15/20	98
		RO-34D	88	RU-K	89	SEC-1G	438	SIX-1P2	175	SOFI-2D	93	STF-1	96			TD-12D	50	TIF-1D	98
RO-5I	87, 153, 175, 234, 252	RO-36D	88	RU-KD	89	SEC-2	138	SIX-2	175, 252	SOFI-2I	93	STF-ID	96			TD-13D	50	TIF-2D	98
		RO-37	88	RU-L	89	SEC-2G	438	SIX-2P	175	SOFI-3I	93	STG-1	95	SUZU-5	319, 34	TD-14D	50	TIF-25D	98
RO-6D	87, 175, 252, 260, 264, 277, 298, 306, 307, 312	RO-37D	88	RU-M	89	SEC-3	138	SIX-2P2	175	SOFI-4	93	STK-1	95	SUZU-5P	319, 34	TD-15	50	TIF-30D	98
		RO-38D	88	RU-TL	88	SEC-3G	438	SIX-3P	156, 167, 169, 175, 224, 231, 240	SOFI-4D	93	STL-ID	94			TD-16	131	TIF-40D	98
RO-6I	87, 175, 252, 260, 264, 277, 298, 306, 307, 312	RO-39	88	RUB-1G	437	SEC-4DP	138	SIX-3P1	156, 175, 188, 230, 252	SOFI-5	93	STL-2I	94	SUZU-6	275	TD-17D	50	TIF-50/60	98
		RO-40	88	RUB-2G	437	SEC-4G	438	SIX-3P2	156, 175, 252	SOFI-6	93	STN-1D	138	SUZU-7	208, 233, 275	TD-18	50	TIG-1D	98
RO-7D	87	RO-40D	88	RUB-3G	448	SEC-7G	439	SIX-4	175, 252	SOP-1D	93	STR-1	95	SUZU-7DP	208, 233, 275	TD-19	50	TIT-2	99
		RO-41	88	RUB-4G	437	SEL-1	410	SIX-4P	175	SOS-1D	93	STR-2	95	SUZU-8	275	TD-20D	50	TIT-3	99
		RO-42	88	RUB-5G	437	SEL-1D	91	SIX-5P	153, 175	SOS-2D	93	STR-3	153, 169	SUZU-8I	275	TD-21	49	TIT-4	99
		RO-43	88	RUB-6G	445	SEL-1I	91	SJL-1	93	SOS-3	93	STR-4	95	SUZU-8IP	275	TD-22	49	TIT-5	99
		RO-44D	88	RUB-7G	437	SEL-2D	91			SOS-4D	93	STR-5	95	SUZU-8P	275	TD-23	131	TIT-6	140
		RO-45	88	RUB-8G	437	SEL-2I	91			STS-1D	95	STR-5	95	SUZU-9P	275	TD-25	131	TIT-10	99
				RUB-9G	437	SEL-3D	91			STS-IDP	95	STR-5	95	SUZU-10	213, 275	TD-26D	131	TIT-11D	99
				RUE-2G	445					STS-II	95	STR-5	95			TD-27	50	TIT-12D	99
				RUS-1	89							STR-5	95			TD-28	50	TIT-13	99





Índice de referencias  
Erreferentzia aurkibidea  
Index des références

Referenzverzeichnis  
Índice de referências  
Spis modeli

REF.	PAG.	REF.	PAG.	REF.	PAG.	REF.	PAG.	REF.	PAG.	REF.	PAG.	REF.	PAG.	REF.	PAG.	REF.	PAG.		
UN-FR	105, 163, 165, 168, 169, 220, 224, 231, 240, 267, 281, 292, 296, 302, 312, 319, 320, 349	VA-3T	445	VA-50	112	VGf-5I	113	VO-HV	164, 197, 255, 269, 286, 287, 289, 290, 298, 301, 310, 313, 314	WAS-2P	163, 224, 236, 273, 282, 313	WIL-33D	116	YA-2X	308	YA-33D	119	YA-226	120
UN-FS	106, 163, 169, 214, 220, 224, 225, 231, 240, 267, 282, 292, 292, 302, 337, 349	VA-4	110	VA-51	112	VI-II	113	VO-HVP	164, 197, 256, 286, 287, 289, 290, 298, 301, 310, 313, 314	WAS-3	154, 298	WIL-34D	116	YA-3D	118	YA-34D	119	YA-227	120
UN-FT	163, 165, 196, 220, 224, 231, 240, 267, 282, 296, 302, 303, 312	VA-4D	110	VA-52	112	VI-2D	113	VO-HVP1	155, 164, 286, 287, 289, 290	WAS-4	154, 298	WIL-35D	116	YA-3G	441	YA-36D	119	YA-228	120
UN-MRN	105, 163, 165, 168, 169, 220, 224, 231, 240, 267, 281, 292, 296, 302, 312, 319, 320, 349	VA-5	110	VA-53	112	VI-2I	113	VO-K	286	WAS-5	233, 297, 298	WIL-36D	116	YA-3I	118	YA-37	119, 352	YA-229	120
UN-NC	154	VA-5T	446	VA-54	112	VI-4D	113	VO-KP	286	WAS-6	233, 297, 298	WIL-37D	116	YA-3X	308	YA-37D	119, 352	YA-232	120
UN-NG	105, 163, 165, 168, 169, 220, 224, 231, 240, 267, 281, 292, 296, 302, 312, 319, 320, 349	VA-6	175, 253, 277	VA-55	112	VI-4DP	113, 349	VO-L	286	WAS-7	352	WIL-38D	116	YA-4G	441	YA-38D	119	YA-272D	119
UN-NH	231, 240, 282	VA-6P	175, 253, 277	VA-56	141	VI-4I	113	VOL-1	283	WAS-7D	352	WIL-39D	116	YA-4X	308	YA-39	118	YA-273D	120
UN-TF	163, 165, 196, 220, 224, 231, 240, 267, 282, 296, 302, 303, 312	VA-7	260, 264, 277, 312	VA-57	112	VI-4IP	113, 349	VOL-1P	283	WAS-9	352	WIL-40D	116	YA-5D	118	YA-39D	118	YA-280D	142
URB-1	110	VA-8D	111	VA-58	141	VI-5D	114	VOL-2	242, 282, 284	WAS-9D	352	WIL-41D	116	YA-5G	412	YA-46D	119	YA-281D	142
URB-1D	110	WINDCOLOR	111	VA-59	112	VI-6D	114	VOL-2D	242, 282, 284	WBS-1	115	WIL-43D	116	YA-5I	118	YA-50	119	YA-282	142
URB-2	110	VA-9D	111	VA-60	112	VI-7	113	VOL-3	242, 282, 284, 295	WE-1	440	WIL-44	116	YA-5X	308	YA-50D	119	YA-283D	142
URB-3D	141	VA-10	161, 181, 182, 260, 262, 264, 312	VA-61C1	357	VI-8	114	VOL-4	284	WE-2G	440	WIL-45D	116	YA-6D	118	YA-51	119	YA-286D	142
URB-4D	141	VA-11	112	VA-61C2	357	VI-8D	114	VOL-5P	284	WE-4D	115	WIL-46D	116	YA-6I	118	YA-51D	119	YA-287D	120
URKO-1D	110	VA-12D	111	VA-62	111	VI-9D	113	VO-M	286, 291, 307	WE-4I	115	WIL-47D	116	YA-6X	308	YA-52D	119	YA-288D	119
URKO-1I	110	VA-13D	110	VA-62D	111	VI-10	114	VO-MP	286, 291, 307	WE-5D	115	WIL-48D	116	YA-7D	118	YA-53	119	YA-300D	120
URKO-2D	110	VA-13I	110	VA-70	141	VI-11	114	VO-MP1	155, 164, 286, 287, 289, 290	WE-5I	115	WIL-49D	116	YA-7I	118	YA-53D	119	YA-301D	142
URKO-2I	110	VA-14D	111	VA-75D	110	VI-11D	114	VO-N	164, 197, 255, 269, 286, 287, 289, 289, 290, 298, 301, 310, 313, 314	WE-6D	115	WIL-50D	116	YA-8D	118, 202, 225, 297, 303, 352	YA-57	119	YA-306	142
URKO-3D	110	VA-15	111	VA-75D WINDCOLOR	111	VI-12	113	VO-NP	164, 197, 256, 286, 287, 289, 290, 298, 301, 310, 313, 314	WE-1	115	WIL-51D	116	YA-8I	118, 202, 225, 297, 303, 352	YA-57D	119	YAMA-1D	293, 343
URKO-3I	110	VA-16	277	VA-91	141	VI-14	142	VO-R	286, 287, 291, 307	WE-2	115	WIL-53	116	YA-9I	118, 202, 225, 297, 303, 352	YA-58	119	YAMA-1I	293, 343
URKO-4	460	VA-17P	260	VA-400	412	VI-15	113	VO-RP	286, 287, 291, 307	WE-3	115	WIL-54	116	YA-10	118	YA-59	119	YAMA-2D	293, 343
V-1G	458	VA-18	253	VA-400	412	VI-16D	114	VO-VA	154	WEI-1	115	WIL-55	116	YA-10D	118	YA-59D	119	YAMA-2I	293, 343
V-1G(CV)	458	VA-19	110	VA-700	412	VILL-1G	446	VO-VAP	154	WEI-2	115	WIL-56	116	YA-11D	118, 225, 297, 306, 352	YA-65	142	YAMA-3D	343
V-2G	458	VA-20	110	VA-DHP	111	VIN-1D	113	VO-VB	164, 197, 247, 255, 269, 286, 287, 289, 289, 290, 298, 301, 310, 313, 314	WEI-3	115	WIL-57D	116	YA-11I	118, 225, 297, 306, 352	YA-72	119	YAMA-4D	293, 343
V-2G(CV)	458	VA-21	110	VA-LA	111	VLK-1	114	VO-VA	154	WEI-4	115	WIL-58D	116	YA-12D	118	YA-79D	119	YAMA-5D	343
V-3G	458	VA-22	110	VA-LB	111	VLK-2	114	VO-VB	164, 197, 247, 255, 269, 286, 287, 289, 289, 290, 298, 301, 310, 313, 314	WEI-5	115	WIL-59D	116	YA-13D	118	YA-81	142	YAMA-5I	343
V-3G(CV)	458	VA-23	110	VA-LC	111	VND-1	113	VO-VP	154	WEI-6	115	WIL-60D	116	YA-14D	118	YA-85D	120	YAMA-6D	293, 343
V-4G(CV)	458	VA-24D	111	VA-LD	111	VND-1D	113	VO-RP	286, 287, 291, 307	WES-1D	115	WIL-61	116	YA-15D	118	YA-88	120	YAMA-6I	293, 343
V-5G(CV)	458	VA-24I	111	VA-LE	111	VND-2	113	VO-RP	286, 287, 291, 307	WHI-1D	115	WIL-62	116	YA-16D	118	YA-89	120	YAMA-7D	293, 343
VA-1	110	VA-25	141	VA-LF	111	VND-2D	113	VO-RP	286, 287, 291, 307	WIL-1D	115	WIL-63D	116	YA-17D	118	YA-91	119	YAMA-7I	293, 343
VA-1T	445	VA-26	141	VA-LG	111	VND-3	113	VO-VA	154	WIL-2D	116	WIL-65D	116	YA-18D	167, 264	YA-92	119	YAMA-8D	293, 343
VA-2	110	VA-27	141	VA-LH	111	VO-1	154, 301	VO-VAP	154	WIL-3D	116	WIL-66D	116	YA-19D	167, 264	YA-92D	119	YAMA-8I	293, 343
VA-2T	445	VA-28	141	VA-LN	111	VO-2	155, 164, 269, 286, 289, 290	VO-VB	164, 197, 247, 255, 269, 286, 287, 289, 289, 290, 298, 301, 310, 313, 314	WIL-4D	116	WIN-1D	117	YA-20D	167, 264	YA-93	119	YAMA-9D	343, 343
VA-3	110, 154	VA-29	111	VA-LN	111	VO-2DP	155, 164, 197, 286, 287, 289, 290	VO-VB	164, 197, 247, 255, 269, 286, 287, 289, 289, 290, 298, 301, 310, 313, 314	WIL-5D	116	WIN-2D	117	YA-21D	167, 265	YA-94	119	YAMA-9I	343, 343
VA-3I	110, 154	VA-29D	111	VA-RA	111	VO-2DP1	287, 289	VO-VB	164, 197, 247, 255, 269, 286, 287, 289, 289, 290, 298, 301, 310, 313, 314	WIL-8	116	WIN-3D	117	YA-22D	118	YA-95	119	YAMA-10D	293, 343
		VA-30	111	VA-RB	111	VO-2P	155, 164, 197, 269, 286, 289, 290	VO-VB	164, 197, 247, 255, 269, 286, 287, 289, 289, 290, 298, 301, 310, 313, 314	WIL-9	116	WIN-4D	117	YA-25D	118	YA-95D	119	YAMA-10I	293, 343
		VA-31D	111	VA-RC	111	VO-2P1	287, 289	VO-VB	164, 197, 247, 255, 269, 286, 287, 289, 289, 290, 298, 301, 310, 313, 314	WIL-10	116	WIN-5D	117	YA-26I	118	YA-98D	120	YAMA-11D	293, 343
		VA-32D	111	VA-RD	111	VO-5P	287	VO-VB	164, 197, 247, 255, 269, 286, 287, 289, 289, 290, 298, 301, 310, 313, 314	WIL-11	116	WIN-6D	117	YA-27D	119, 154, 303, 352	YA-99D	120	YAMA-12D	293, 343
		VA-32D	111	VA-RDH	111	VO-6D	287	VO-VB	164, 197, 247, 255, 269, 286, 287, 289, 289, 290, 298, 301, 310, 313, 314	WIL-12	116	WIN-21	117	YA-28	119	YA-100D	120	YAMA-12I	293, 343
		VA-33D	111	VA-RDM	111	VO-7	183, 246, 285, 288, 290, 297, 305, 307	VO-VB	164, 197, 247, 255, 269, 286, 287, 289, 289, 290, 298, 301, 310, 313, 314	WIL-13	116	WIN-22	117	YA-28D	119	YA-101D	120	YAMA-13D	293, 343
		VA-33D	111	VA-RE	111	VO-8P	155, 164, 197, 286, 287, 289, 290	VO-VB	164, 197, 247, 255, 269, 286, 287, 289, 289, 290, 298, 301, 310, 313, 314	WIL-14	116	WIN-5D	117	YA-29	118	YA-102D	120	YAMA-14D	293, 343
		VA-34	260	VA-RF	111	VO-8P1	287, 289	VO-VB	164, 197, 247, 255, 269, 286, 287, 289, 289, 290, 298, 301, 310, 313, 314	WIL-15	116	WIN-5D	117	YA-29D	118	YA-103D	120	YAMA-14I	293, 343
		VA-34P	176, 26	VA-RG	111	VO-AH	164, 197, 255, 269, 286, 287, 289, 290, 298, 301, 310, 313, 314	VO-VB	164, 197, 247, 255, 269, 286, 287, 289, 289, 290, 298, 301, 310, 313, 314	WIL-16	116	WIN-5D	117	YA-30	119, 46	YA-108	120	YAMA-15D	293, 343
		VA-34P2	176, 26	VA-RH	111	VO-AHP	164, 197, 256, 286, 287, 289, 290, 298, 301, 310, 313, 314	VO-VB	164, 197, 247, 255, 269, 286, 287, 289, 289, 290, 298, 301, 310, 313, 314	WIL-17D	116	WIN-5D	117	YA-31D	119	YA-111	120	YAMA-16D	293, 343
		VA-35	111	VA-RHM	111	VO-FHP	286	VO-VB	164, 197, 247, 255, 269, 286, 287, 289, 289, 290, 298, 301, 310, 313, 314	WIL-18	116	WIN-5D	117	YA-32D	117	YA-112	120	YAMA-16I	293, 343
		VA-35D	111	VA-RJ	111	VO-FHP1	287	VO-VB	164, 197, 247, 255, 269, 286, 287, 289, 289, 290, 298, 301, 310, 313, 314	WIL-19D	116	WIN-5D	117			YA-113	120	YAMA-17D	293, 343
		VA-36	112	VA-RK	111			VO-VB	164, 197, 247, 255, 269, 286, 287, 289, 289, 290, 298, 301, 310, 313, 314	WIL-20	142	WIN-5D	117			YA-113	120	YAMA-18D	341, 343
		VA-37	112	VA-RL	111			VO-VB	164, 197, 247, 255, 269, 286, 287, 289, 289, 290, 298, 301, 310, 313, 314	WIL-21	116	WIN-5D	117			YA-113	120	YAMA-18DP	276, 293
		VA-38	112	VA-RL	111			VO-VB	164, 197, 247, 255, 269, 286, 287, 289, 289, 290, 298, 301, 310, 313, 314	WIL-22	116	WIN-5D	117			YA-113	120	YAMA-18IP	341, 344
		VA-39	112	VA-RM	111			VO-VB	164, 197, 247, 255, 269, 286, 287, 289, 289, 290, 298, 301, 310, 313, 314	WIL-23	116	WIN-5D	117			YA-113	120	YAMA-19D	341, 343
		VA-40	112	VA-RN	111			VO-VB	164, 197, 247, 255, 269, 286, 287, 289, 289, 290, 298, 301, 310, 313, 314	WIL-24	116	WIN-5D	117			YA-113	120	YAMA-19DP	276, 293, 341, 344
		VA-41	112	VA-ROK	111			VO-VB	164, 197, 247, 255, 269, 286, 287, 289, 289, 290, 298, 301, 310, 313, 314	WIL-25	116	WIN-5D	117			YA-113	120		
		VA-42	112	VB-ID	113			VO-VB	164, 1										



Índice de referencias  
Erreferentzia aurkibidea  
Index des références

Referenzverzeichnis  
Índice de referências  
Spis modeli

REF.	PAG.
YAMA-19IP	276, 293, 341, 344
YAMA-20D	341, 343
YAMA-20DP	276, 293, 341, 344
YAMA-20I	341, 343
YAMA-20IP	276, 293, 341, 344
YAMA-21I	326, 344
YAMA-21IP	326, 344
YAMA-22DP	341
YAMA-22IP	341
YAMA-23DP	341
YAMA-23IP	341
YAMA-24DP	341
YAMA-24IP	341
YAMA-25DP	344
YAMA-25P	344
YAMA-26	344
YAMA-26D	344
YAMA-26DP	344
YAMA-26P	344
YAMA-27	329, 333, 344
YAMA-27D	329, 333, 344
YAMA-27DP	329, 333, 344
YAMA-27P	329, 333, 344
YAMA-28P	276, 293, 341, 344
YAMA-29P	276, 293, 341, 344
YAMA-30P	333, 344
YAMA-32DP	344
YAMA-33DPI	344
YAMA-34	344
YAMA-34D	344
YAMA-36DP	345
YAR-1	143
YAR-2	143
YAR-3	143
YAR-4D	143
YET-1	120
YET-1D	120
YET-2	121
YET-2D	121
YET-3D	121
YET-4	121
YET-4D	121
YET-5	121
YET-5D	121
YET-6	121
YET-6D	121
YET-7	121
YET-7D	121
YET-8	121
YET-8D	121
YET-9	121
YET-9D	121
YET-10	121
YET-10D	121
YET-11	121

REF.	PAG.
YET-11D	121
YET-12	121
YET-13	121
YET-14	120
YET-14D	120
YET-15	121
YET-16	121
YET-17D	121
YET-18	121
YET-18D	121
YET-19D	143
YU-1D	294
YUH-1D	121
YUH-2D	121
YUH-3D	121
YW-1P	122
ZA-6DP	326, 339
ZA-1	122, 274, 317, 318, 319, 321, 322, 323, 324, 326, 332, 333, 334, 335, 336, 337, 338, 339, 340, 341, 345, 349
ZA-1P	122, 274, 317, 318, 319, 321, 322, 323, 324, 326, 332, 333, 334, 335, 336, 337, 338, 339, 340, 341, 345, 349
ZA-2P	154, 317, 318, 321, 323, 326, 329, 333, 336, 339, 341, 345, 349
ZA-3D	349
ZA-4DP	154, 317, 318, 321, 323, 326, 329, 333, 336, 339, 341, 345, 349
ZA-5DP	155
ZA-5P	155
ZA-6DP	320
ZA-6DPI	317, 318, 333, 339, 345
ZA-7DP	326, 339
ZA-7DPI	320, 326, 339
ZA-8P	321, 329, 332, 333, 339
ZA-9P	329
ZA-9P1	317, 318, 326, 327, 329, 331, 334, 335, 341, 342, 345
ZA-9P2	317, 318, 333, 339, 345
ZA-10	349
ZA-12	122, 338

REF.	PAG.
ZA-13P	154, 317, 318, 321, 323, 326, 329, 333, 336, 339, 341, 345, 349
ZE-1	59
ZE-1D	59
ZE-1X	308
ZE-2	59
ZE-2D	59
ZE-2X	308
ZE-3X	309
ZE-4X	309
ZE-5D	59
ZE-5I	59
ZE-5X	309
ZE-6	59
ZE-6D	59
ZE-6X	309
ZE-7D	59
ZE-7X	309
ZE-8	59
ZE-8X	309
ZE-9D	59
ZE-9X	309
ZE-10D	60
ZE-11D	60
ZE-13	60
ZE-15	59
ZE-16D	59
ZE-17D	59
ZE-18D	59
ZE-19	59
ZE-20	59
ZE-21D	59
ZE-22	59
ZE-23D	60
ZE-24D	60
ZE-25D	60
ZE-26D	60
ZE-27D	60
ZE-28D	60
ZE-29D	60
ZE-30D	60
ZE-31D	60
ZE-32D	60
ZE-33D	60
ZE-34D	60
ZE-35	60
ZE-35D	60
ZE-36D	59
ZE-37D	59
ZE-38	59
ZE-39	59
ZE-40D	59
ZE-41	59
ZE-42	59
ZE-43	59
ZE-44D	59
ZE-45D	59

REF.	PAG.
ZE-46	59
ZE-47D	60
ZE-48D	60
ZE-49D	60
ZE-50D	60
ZE-51D	60
ZE-52D	60
ZE-53D	60
ZE-54D	60
ZE-55D	60
ZE-56D	60
ZE-57D	60
ZE-58D	60
ZE-59D	60
ZE-60D	60
ZE-61D	60
ZE-62D	60
ZE-63D	60
ZE-64D	60
ZE-65D	60
ZE-66D	60
ZE-67D	60
ZE-68D	60
ZE-69D	60
ZE-70D	60
ZE-71D	59
ZE-72	59
ZE-73	59
ZE-74	59
ZE-75	59
ZE-76D	59
ZE-77D	59
ZE-78D	59
ZE-79	59
ZE-80	59
ZE-81	59
ZE-82	59
ZE-83	59
ZE-84	59
ZE-85	59
ZE-86D	59
ZE-87	59
ZE-88	59
ZE-89	59
ZE-90	59
ZE-91D	59
ZE-92D	59
ZE-93D	59
ZE-94D	59
ZE-95D	59
ZE-96D	59
ZE-97D	59
ZE-98	59
ZE-99	59
ZE-101	59
ZE-102	59
ZE-103	59
ZE-104D	59
ZE-105D	60
ZE-106D	60

REF.	PAG.
ZE-107D	60
ZE-108D	60
ZE-109D	60
ZE-110D	60
ZE-111D	60
ZE-112D	60
ZE-113D	60
ZE-114D	60
ZE-115D	60
ZE-116D	60
ZE-117D	60
ZE-118	59
ZE-119D	59
ZE-120	59
ZE-121D	60
ZE-122D	60
ZE-123D	60
ZE-124	60
ZE-125D	60
ZE-126D	60
ZE-127D	60
ZE-128	60
ZE-129D	60
ZE-130	60
ZE-131	60
ZE-132D	60
ZE-133D	60
ZE-134	60
ZE-135D	60
ZE-136D	60
ZE-137	60
ZE-138	60
ZE-139D	60
ZE-140	60
ZE-141D	60
ZE-142	60
ZE-143	60
ZE-144D	60
ZE-145D	60
ZE-146D	60
ZE-147D	60
ZE-148D	60
ZE-149	60
ZE-14D	59
ZE-150	60
ZE-151D	60
ZE-152D	60
ZE-153D	60
ZE-154D	60
ZE-155D	60
ZE-156	60
ZE-157	60
ZE-158	60
ZE-159D	60
ZE-160D	61
ZE-K1	61
ZE-K2	61
ZE-K5	61
ZE-K6	61

REF.	PAG.
ZE-N1	61
ZEN-ID	122
ZA-4DP	317, 318, 321, 323, 326, 329, 333, 336, 339, 341, 345
ZA-4DP	349
ZA-5DP	155
ZA-5P	155
ZA-6DP	320
ZA-6DPI	317, 318
ZA-6DPI	318, 333, 339, 345
ZA-7DP	326, 339
ZA-7DPI	320
ZA-7DPI	326, 339
ZA-8P	321, 329, 332, 333, 339
ZA-9P	329
ZA-9P1	317, 318, 326, 327, 329, 331, 334, 335, 341, 342, 345
ZA-9P2	317, 318, 333, 339, 345
ZE-1	59
ZE-100	59
ZE-101	59
ZE-102	59
ZE-103	59
ZE-104D	59
ZE-105D	60
ZE-106D	60
ZE-107D	60
ZE-108D	60
ZE-109D	60
ZE-110D	60
ZE-111D	60
ZE-112D	60
ZE-113D	60
ZE-114D	60
ZE-115D	60
ZE-116D	60
ZE-117D	60
ZE-118	60
ZE-119D	60
ZE-120	60
ZE-121D	60
ZE-122D	60
ZE-123D	60
ZE-124	60
ZE-125D	60
ZE-126D	60
ZE-127D	60
ZE-128	60
ZE-129D	60
ZE-130	60
ZE-131	60
ZE-132D	60
ZE-133D	60
ZE-134	60
ZE-135D	60
ZE-136D	60
ZE-137	60
ZE-138	60
ZE-139D	60
ZE-140	60
ZE-141D	60
ZE-142	60
ZE-143	60
ZE-144D	60
ZE-145D	60
ZE-146D	60
ZE-147D	60
ZE-148D	60
ZE-149	60
ZE-14D	59
ZE-150	60
ZE-151D	60
ZE-152D	60
ZE-153D	60
ZE-154D	60
ZE-155D	60
ZE-156	60
ZE-157	60
ZE-158	60
ZE-159D	60
ZE-160D	61
ZE-K1	61
ZE-K2	61
ZE-K5	61
ZE-K6	61

REF.	PAG.
ZE-131	60
ZE-132D	60
ZE-133D	60
ZE-134	60
ZE-135D	60
ZE-136D	60
ZE-137	60
ZE-138	60
ZE-139D	60
ZE-140	60
ZE-141D	60
ZE-142	60
ZE-143	60
ZE-144D	60
ZE-145D	60
ZE-146D	60
ZE-147D	60
ZE-148D	60
ZE-149	60
ZE-14D	59
ZE-15	59
ZE-150	60
ZE-151D	60
ZE-152D	60
ZE-153D	60
ZE-154D	60
ZE-155D	60
ZE-156	60
ZE-157	60
ZE-158	60
ZE-159D	60
ZE-160D	61
ZE-16D	59
ZE-17D	59
ZE-18D	59
ZE-19	59
ZE-1D	59
ZE-1X	308
ZE-2	59
ZE-20	59
ZE-21D	59
ZE-22	59
ZE-23D	60
ZE-24D	60
ZE-25D	60
ZE-26D	60
ZE-27D	60
ZE-28D	60
ZE-29D	60
ZE-2D	59
ZE-2X	308
ZE-30D	60
ZE-31D	60
ZE-32D	60
ZE-33D	60
ZE-34D	60
ZE-35	60
ZE-35D	60
ZE-36D	60
ZE-37D	59
ZE-38	59
ZE-39	59
ZE-40D	59
ZE-41	59
ZE-42	59
ZE-43	59
ZE-44D	59
ZE-45D	59

REF.	PAG.
ZE-37D	59
ZE-38	59
ZE-39	59
ZE-3X	309
ZE-40D	59
ZE-41	59
ZE-42	59
ZE-43	59
ZE-44D	59
ZE-45D	59
ZE-46	59
ZE-47D	60
ZE-48D	60
ZE-49D	60
ZE-4X	309
ZE-50D	60
ZE-51D	60
ZE-52D	60
ZE-53D	60
ZE-54D	60
ZE-55D	60
ZE-56D	60
ZE-57D	60
ZE-58D	60
ZE-59D	60
ZE-5D	59
ZE-5I	59
ZE-5X	309
ZE-6	59
ZE-60D	60
ZE-61D	60
ZE-62D	60
ZE-63D	60
ZE-64D	60
ZE-65D	60
ZE-66D	60
ZE-67D	60
ZE-68D	60
ZE-69D	60
ZE-6D	59
ZE-6X	309
ZE-70D	60
ZE-71D	59
ZE-72	59
ZE-73	59
ZE-74	59
ZE-75	59
ZE-76D	59
ZE-77D	59
ZE-78D	60
ZE-79	59
ZE-7D	59
ZE-8	59
ZE-80	59
ZE-81	59
ZE-82	59
ZE-83	59
ZE-84	59
ZE-85	59

REF.	PAG.
------	------

REF.	PAG.
------	------

Índice de marcas  
Marken aurkibidea  
Index des marques

Markenverzeichnis  
Índice de marcas  
Spis marek

FOR:	NAT.	PAG.
101 ®	PORTUGAL	
126 ®	SUECIA	402
303 ®	TAIWÁN	2
333 ®	ISRAEL	2
3M ®	CHINA	2
45 ®	RUSIA	2
716 ®	PORTUGAL	402
A.M. BARAS ®	REINO UNIDO	2284
ABA ®	FINLANDIA	2
ABARTH ®	ITALIA	354
ABBES ®		68, 348
ABC ®	ESPAÑA	2, 124
ABLOY ®	FINLANDIA	2, 3
ABSA ®	ESPAÑA	3, 25, 87, 146, 150, 153, 172, 175, 193, 230, 234, 252, 260, 264, , 277, 298, 306, 307, 312, 314
ABT ®		113, 114
ABUS ®	ALEMANIA	3, 4, 5, 6, 7, 11, 21, 30, 31, 49, 54, 58, 64, 81, , 87, 101, 113, 114, 118, 119, 122, 124, 128, 150, 154, 225, 297, 303, 306, 346, 347, 349, 346, 347, 349, 350, 352
ACE ®		146, 326
ADAMSRITE ®	REINO UNIDO	7
ADEMCO ®		119, 146, 326
AEP ®	RUSIA	7
AGA ®	ESPAÑA	7, 8, 15, 24, 146, 326, 402, 443, 446, 447, 452, 453
AGB ®	ITALIA	8, 125, 409
AGC ®	PORTUGAL	8, 136, 372
AGE ®	JAPÓN	8
AGUEDA ®		97
AGUIA ®	PORTUGAL	8
AGUT ®	ESPAÑA	9
AHRAM ®	EGIPTO	125
AIZPUTE ®	RUSIA	9
AKARSAN ®	TURQUÍA	412
AKIRA ®		120, 121
AKS ®		155, 163, 164, 169, 177, 195, 197, 247, 248, 255, 256, 268, 269, 271, , 285, 286, 287, 288, 289, 290, 291, 298, 299, 301, 307, 309, 310, 313, 314
AL ®		10
ALA ®		31, 372
ALDRIDGE ®	REINO UNIDO	9
ALE ®	ESPAÑA	9
ALEDAL ®	SUECIA	443
ALFA ®		7, 9, 51
ALFA ROMEO ®	ITALIA	354
ALIANCA ®	BRASIL	9
ALLGOOD ®		26
ALLIANDIS ®		133
ALPHA ®	JAPÓN	9, 10, 146, 326
ALSO ®		65225
ALTAY ®	RUSIA	10
ALUNORM ®		32
AM ®		78
AMARU ®	PORTUGAL	10
AMERICAN LOCK ®	ESTADOS UNIDOS	10
AMERICAN MOTORS ®		64, 65, 159, 224, 257, 306, 351
AMIG ®	ESPAÑA	10, 65, 125, 126

FOR:	NAT.	PAG.
ANA ®		377
ANCHOR ®		3, 4, 5, 10, 346
ANKE ®		23
ANKER ®	PAÍSES BAJOS	10, 11
ANKERSLOT ®		10, 7
ANLO ®		54444
ANTAR ®	FRANCIA	11, 87, 88
ANTONIOLI ®	ITALIA	412, 413
APEKS ®		125
APEX ®	RUSIA	11, 125
APRI ®		78
APRILIA ®		317, 318, 333, 339, 345
ARCU ®	ESPAÑA	11, 129, 443, 444
AREL ®	REINO UNIDO	11
ARES ®	RUSIA	447
ARFE ®		3, 11, 35, 86, 150, 215, 230, 274, 446, 447, 449
ARMAN ®		162, 163, 166, 178, 186, 187, 188, 189, 191, 192, 193, 194, 223, 224, , 231, 236, 256, 268, 269, 273, 281, 282, 294, 313
ARMOR ®		87
ARMSTRONG ®		4, 11
ARNOU ®		25
AROUCA ®	BRASIL	11
ARREGUI ®		3, 7, 12, 21, 25, 43, 49, 150, 193, 230, 274
ARROW ®	ESTADOS UNIDOS	12
ARSENEVSK ®	RUSIA	12
ARTEB ®		159, 166, 188, 190, 230, 269, 334
ASEC ®		9, 12
ASHICO ®	CHINA	126
ASIA ®	TAIWÁN	12, 120, 121
ASPA ®	PAÍSES BAJOS	12, 37
ASSA ®	SUECIA	12, , 13, 14, 89, 97, 291, 318, 342, 346, 347, 402, 403, 413
ASSA ABLOY ®		120
ASTON MARTIN ®	ALEMANIA	354
ASTRAL ®		128
ATAL ®		68, 69, 110, 151, 348
ATL ®		22
ATLANTIC ®		131
ATLAS ®	ESTADOS UNIDOS	14, 96
ATP ®		25
ATRA ®		129, 133, 413, 233
AUDI ®	ALEMANIA	354
AUMON ®	ESPAÑA	14, 35345
AUNO ®		412, 413
AUTOBLOCK ®		153, 188, 190
AVA-CHUBB ®		29, 128
AVANGARD ®	RUSIA	14
AXA ®	SUECIA	14, 126, 128, 129
AXIS ®		128
AYPE ®	ESPAÑA	444
AZBE ®	ESPAÑA	14, 15, 117, 126
AZKOYEN ®	ESPAÑA	15
B+D ®	REINO UNIDO	15, 73
BAB ®		3, 15, 16, 35, 42, 87
BAGEM ®	ESPAÑA	2, 124, 126

FOR:	NAT.	PAG.
BALING LOCK ®		140
BALTIKA ®	RUSIA	16
BANE SEKULIC ®		21, 141
BANHAM ®	REINO UNIDO	16
BAODEAN	CHINA	126
BAODELI ®	CHINA	16
BARCZ ®	POLONIA	16
BARIER ®	RUSIA	146
BARRO ®		37
BASCO ®		66, 150, 170, 203, 204, 205, 207, 208, 209, 210, 212, 221, 225, 226, 299, 306, 348, 351
BASI ®	ALEMANIA	16, 126, 140
BASTA ®	IRLANDA	17, 74, 152, 154, 317, 318, 321, 323, 326, 329, 333, 336, 339, 341, , 346, 348, 349
BATON ®	TAIWAN	126
BATU ®	ESPAÑA	17, 30, 59, 347, 246
BAU ®		110
BEFA ®		116
BELL ®		120, 121
BENCO ®		97
BENDIX ®		118, 119, 154, 225, 297, 303, 306, 339, 345, 349, 350, 352
BERAM ®		113
BERRY ®		18, 27
BERTOLOTI ®		98
BEST ®	ESTADOS UNIDOS	17
BETA ®	ITALIA	17, 317, 318, 333, 339, 345, 413, 414
BEY ®	TURQUIA	127
BIBERING ®	ALEMANIA	17312
BIELLE ®	ITALIA	17
BIFFAR ®	ALEMANIA	17, 100, 116
BILMA ®	ESPAÑA	146
BILTEMA ®		347
BIRD ®		50, 118
BKS ®	ALEMANIA	6, 18, 19, 50, 70, 118, 120, 346, 336
BLACK & DECKER ®		34
BLAU ®		150, 164, 193, 195, 196, 199, 200, 215, 236, 257, 284, 288, 289, 290, 207, 307, 309, 313, 320
BLOCK ®		183, 184
BLOCTOUT ®		20
BLOCUS ®		85, 87
BLOSTER ®		151, 159, 166, 180, 183, 184, 187, 189, 190, 191, 193, 226, 228, 234, , 256, 269, 271, 282, 294, 296, 301, 309, 323, 324, 331, 334, 335, 347, 348
BLUMA ®	ALEMANIA	372
BMB ®	ALEMANIA	20
BMC ®	ITALIA	414
BMH ®		453
BOBCAT ®		159, 257, 306, 315, 351
BODA ®	FINLANDIA	20, 26, 27, 28, 403, 414, 438
BOGATIR ®	RUSIA	414, 373
BOMBARDIER ®		350
BOMORO ®	ALEMANIA	20, 112, 236, 272, 352
BONAITI ®	ITALIA	387, 409
BORKEY ®	ALEMANIA	127

FOR:	NAT.	PAG.
BOSCH ®	ALEMANIA	151, 157, 161, 180, 228, 246, 262, 272, 273, 282, 299, 306, 307, 310, , 340, 350, 351, 352
BOULTON & PAUL ®	REINO UNIDO	20
BOXAFE ®	ITALIA	415
BRABANTIA ®	ESPAÑA	20, 32, 42, 77
BRAS ®	ESPAÑA	20
BRASIL ®	BRASIL	20
BRETER ®		122, 274, 317, 318, 319, 321, 322, 323, 324, 326, 332, 333, 334, 335, , 337, 338, 339, 340, 341, 345, 349
BRICARD ®	FRANCIA	20, 21, 67, 71, 90, 124, 127, 128, 372, 403
BRIGGS & STRATTON ®		66, 73, 155, 159, 160, 167, 171, 180, 181, 202, 203, 204, 205, 206, , 208, 209, 210, 211, 212, 214, 220, 221, 222, 224, 225, 226, 232, 233, 247, 248, 254, 255, 257, 282, 287, 297, 304, 306, 314, 315, 326, 348, 351
BRISANT ®	REINO UNIDO	127
BRITAX ®		164, 198, 220, 223, 239, 284, 265, 296
BRUMME ®	ALEMANIA	21, 59
BSS ®	SERBIA Y MONTENEGRO	21
BTV ®	ESPAÑA	21, 37, 95, 96, 126, 431, 432
BUFFO ®		4, 5, 126, 150, 346
BUGA ®	ALEMANIA	21
BUICK ®	ALEMANIA	354
BULAT ®	RUSIA	22, 127
BULIT ®		3, 64, 65, 346
BURG ®	ALEMANIA	4, 5, 22, 23, 24, 35, 61, 82, 87, 114, 127, 150, 346, 372, , 447
BURG WACHTER ®	ALEMANIA	22, 23, 24, 127, 429, 430
BURGHOWT ®		98
BUS ®	ALEMANIA	24
BUVA ®	ALEMANIA	22, 24, 52, 239
BWS ®		32, 35
BY ®		25
BYP ®		125, 132
C.A.R.S. ®		82
C.V.C. ®		125
CAB ®	ITALIA	24, 25, 118, 119, 154, 225, 297, 303, 306, 349, 350, 352
CADILLAC ®	ALEMANIA	354
CAF ®	ITALIA	415
CAIB ®		137
CAM ®		438224
CAM LOCK ®	ESTADOS UNIDOS	24
CAMA ®		150
CAMBOA ®		32
CANADA POST ®	CANADÁ	24
CAP ®		25, 85
CARAT ®		50, 118
CARL F ®	REINO UNIDO	24
CARTERO ®	ESPAÑA	24, 25
CAS ®		130
CAS CISMA ®	ITALIA	25, 453
CASAS ®		124
CASELLAS ®		337
CASH BOX ®	ALEMANIA	25, 43, 77

Índice de marcas  
Marken aurkibidea  
Index des marques

Markenverzeichnis  
Índice de marcas  
Spis marek

FOR:	NAT.	PAG.
CASI ®		91, 155, 163, 164, 177, 178, 183, 195, 197, 198, 199, 200, 202, 223, , 255, 265, 268, 269, 286, 287, 288, 290, 294, 297, 299, 301, 302, 307, 309, 310, 313, 314
CASMA ®		26, 28
CATERPILLAR ®	ESTADOS UNIDOS	350
CATOR ®		88
CAVERS ®	FRANCIA	25, 26, 126, 138, 260
CAYS ®	ESPAÑA	26, 35, 127, 139
CAZORLA ®		35
CC ®		98
CCF ®	PORTUGAL	373
CCL ®		34
CEM ®		72, 162, 163, 165, 194, 195, 196, 197, 198, 199, 200, 202, 220, 223, , 231, 239, 240, 265, 266, 267, 282, 294, 296, 301, 302, 312, 348
CEMA ®	ITALIA	26
CENTURION ®		126
CENTURY ®	REINO UNIDO	26418
CERRAMARC ®	ESPAÑA	26
CERUTTI ®	ITALIA	415, 416, 444
CES ®	ALEMANIA	26, 27, 28, 29, 127
CESSNA ®		150
CF ®		49, 435
CFP ®		116
CHANGE-O-MATIC ®		33195
CHAVO ®	PORTUGAL	5, 29, 30, 31
CHELIABINSK ®	RUSIA	29
CHEVROLET (KR) ®	ALEMANIA	354
CHEYLOCK ®	HONG KONG	29
CHG ®		50
CHICAGO ®	ESTADOS UNIDOS	29, 118, 119, 146, 154, 225, 297, 303, 306, 326, , 350, 351, 352
CHRIST ®		37
CHRYSLER ®		150, 159, 160, 170, 172, 180, 181, 202, 207, 224, 249, 254, 255, 257, , 262, 276, 286, 287, 297, 308, 309, 311
CHUBB ®	REINO UNIDO	29, 128, 403, 404, 416
CIB ®		49, 83, 85, 104
CIBC ®		49
CIBOX ®		22
CIEF ®	FRANCIA	29
CIFIAL ®	PORTUGAL	29, 373207
CILA GENTILI ®	ITALIA	30
CINA ®	TAIWÁN	12, 30, 41, 92
CISA ®	ITALIA	3, 4, 5, 6, 30, 31, 72, 73, 124, 128, 346, 347, 349, 417
CITADEL ®		3
CITROEN ®	ITALIA	354, 355, 356
CITY ®		25, 26, 49
CLARK FORK LIFT ®	ESTADOS UNIDOS	31
CLASS ®	RUSIA	418
CLASSIC ®		32
CLAUSOR ®		32, 77, 152, 155, 157, 159, 160, 161, 162, 164, 172, 174, 182, 183, 233, 215, 225, 239, 250, 253, 258, 260, 263, 265, 268, 293, 308, 309, 311, 334, 335, 336, 337, 338, 339, 340, 343, 352

FOR:	NAT.	PAG.
CLEMSA ®	ESPAÑA	32
CLICK ®		287
CLUM ®		351
COBRA ®		347
CODEM ®		131
CODKEY ®		138
COFER ®		76
COHNKO ®	RUSIA	32
COLE HERSEE ®		118, 119, 154, 225, 297, 303, 306, 349, 350, 352
COLLBAIX ®		124
COLOMENCA ®		124
COM ®	ALEMANIA	32
COMBA ®		27, 66, 100
CORBIN ®	ITALIA	32, 33, 34, 35, 37, 128, 129, 130, 150, 159, 170, 203, 204, 205, , 208, 209, 210, 212
CORNI ®	ITALIA	32, 139, 409, 418305
CORONA ®	ALEMANIA	35, 61
CORSA ®		97
COTICO ®	ALEMANIA	35
COUILLET ®		86
CR ®	ITALIA	378, 418, 419, 420
CRAIN ®		135
CRAZY LOCKS ®	TAIWÁN	35
CRC ®	PORTUGAL	32, 373
CROMODORA ®		150, 151, 156, 165, 166, 179, 183, 184, 185, 187, 188, 192, 218, 227, , 246, 256, 267, 269, 271, 282, 294, 296, 299, 301, 309, 318, 324, 325, 327, 332, 335, 338, 341, 347, 348
CRONOS ®	ESTADOS UNIDOS	447
CUBELLS ®	ESPAÑA	35
CVL ®	ESPAÑA	35, 128
CWS ®		37
DACIA ®	RUMANIA	175, 176, 247, 262, 355
DAD ®	FRANCIA	35, 37, 49, 96, 110, 111
DAELIM ®		342
DAEWOO ®		170, 176, 205, 274
DAF ®	TURQUÍA	36, 128
DAIHATSU ®		167, 177, 178, 254
DAMM ®		18
DAR-MAR ®	POLONIA	404
DARMIX ®		#N/D
DASS ®	ESPAÑA	128, 129
DATSUN ®		157, 179, 182, 183, 218, 236, 242, 243, 244, 245, 246, 272, 273, 304, , 309
DAV ®		297, 306, 311
DC ®		87
DEBEAURAIN ®	FRANCIA	55, 87, 140, 141, 373, 404
DEBEAURAIN-ND ®	FRANCIA	404
DECAYEUX ®		35, 83, 86, 139, 140
DEFA ®	NORUEGA	36178
DEHA ®		120, 121
DEKABA ®	BULGARIA	36, 75, 128, 129, 420
DELAPORTE ®	FRANCIA	36
DELCA ®	GRECIA	129
DELMET ®	POLONIA	36
DELTA ®	REINO UNIDO	129, 128, 324
DENY ®	FRANCIA	420

FOR:	NAT.	PAG.
DERLOCHE ®		87
DESAL ®		23
DESPREZ ®		87
DEXTER ®	ITALIA	36, 53, 159, 306, 351
DIAMOND ®	TAIWÁN	36
DIEBOLD ®		37, 46
DIERRE ®	ITALIA	129, 133, 136
DIFA ®		88
DIMITROVGRAD ®	RUSIA	37
DINBOX ®	NORUEGA	37
DIRAK ®		36
DJC ®		98
DNS ®		56
DOBLE SAFE ®		72, 73, 319, 339
DOBLINA ®		281, 292
DOCO ®		35
DOM ®	ALEMANIA	32, 37, 38, 39, 40, 79, 80, 96, 129, 130, 139, 162, 163, 166, 183, 184, 187, 189, 191, 194, 223, 224, 225, 231, 232, 236, 255, 256, 269, 281, 294, 313
DOMINION LOCK ®	ESTADOS UNIDOS	12, 4
DOMUS ®	ITALIA	25, 40, 130, 428
DONNER ®		67, 97
DOOR LOCK ®		374
DOUBLE CIRCLE ®	TAIWÁN	40, 41
DRAPER ®		119
DUBOIS ®		68, 69, 173, 250, 262, 297, 302, 306, 311, 312, 314, 342, 348
DUPLEX ®	RUSIA	447
DURABLE ®		22
DURALOCK ®	ESTADOS UNIDOS	41
DVERNIAC ®	RUSIA	420, 421, 447, 448
EAG ®	ALEMANIA	41
EAGLE ®	ESTADOS UNIDOS	41, 56
EAO ®		39
EBA ®		77
ECHO ®		150
ECM ®	ITALIA	41
EFER ®		29
EIKO ®	JAPÓN	41
ELBOR ®	RUSIA	421
ELCA ®		43, 44, 139
ELEDIS ®		42
ELEPHANT ®		102
ELFIN ®		26
ELMO ®		306, 351
ELSEY ®		77
ELZETT ®	HUNGRIA	26, 41, 130, 405, 422
EMGE ®		87
EMHART ®		87, 129
EMKA ®	FRANCIA	36, 41, 43, 49, 153
EMOH ®		164, 284, 288, 289
ENA OQ ®		104
EP PINSON ®	REINO UNIDO	42
EPO ®		90
EQUIBATIR ®		87
ERA ®	REINO UNIDO	42, 405

FOR:	NAT.	PAG.
EREVAN ®	RUSIA	422, 448
ERINRUDE ®		352
ERMEX ®		97
ESA ®	ESPAÑA	42, 405
ESAFE ®		29, 37, 76, 98, 107, 136, 139, 140, 141
ESCO ®		5, 30, 31, 32, 33, 97
ESETY ®	ITALIA	422, 423
ESLA ®	REINO UNIDO	42
ESP ®	ESTADOS UNIDOS	42
ESS ®	ALEMANIA	42
ESSENDIA ®		5, 30, 31
ESZ ®		63
ET. POWER ®		97
ETAS ®	REINO UNIDO	42
ETNA ®		25, 84
EUREKA ®	ITALIA	42
EURO ®		35
EURO BOX ®	REINO UNIDO	42
EURO LOCKS ®	BE LGICA	17, 43, 68, 72, 73, 86, 130, 146, 319, 326, 339, 348
EURONORM ®		32, 33
EUROP ®		96
EUROPARTNER ®		33
EUROPROFIL ®	POLONIA	43, 53
EUROSPEC ®	REINO UNIDO	51, 106, 118, 405
EUROTEMPLE ®	ITALIA	423
EVERGOOD ®	TAIWÁN	43, 93
EVVA ®	AUSTRIA	43, 44
EXCEL ®	FRANCIA	44
EXEM ®		133
EXPRES ®	POLONIA	44, 51, 71, 121
EZCURRA ®	ESPAÑA	44, 130, 138, 424
EZSET ®		67
FAAB ®		150, 157, 165, 173, 185, 227, 310, 318, 322, 327, 334, 338
FAB ®	REPÚBLICA CHECA	45, 55, 269, 270
FAC ®	ESPAÑA	7, 24, 25, 45, 46, 65, 112, 130, 131, 134, 139, 424
FACCHINETTI ®		48, 131336
FACEF ®		428
FADE ®		59, 87
FAI ®		114
FAICA ®		150
FAINER ®	PORTUGAL	46
FALCON ®	ESTADOS UNIDOS	17, 46, 115
FAMA ®	BRASIL	46
FANA ®	ALEMANIA	21, 46
FARMA ®		151, 184, 219, 249, 257, 319, 322, 325, 327, 331, 336, 341, 347
FAS - YALE ®	SUECIA	405, 406
FAS ®	SUECIA	46, 424, 425
FASEM ®	ITALIA	17, 46
FASMA ®		43
FAVOUR ®	ARGELIA	47, 131
FAYN ®	TAIWÁN	131, 374
FB ®		124
FCV ®	ALEMANIA	47, 66, 131226
FEB ®	ITALIA	9, 29, 65, 84, 425

Índice de marcas  
Marken aurkibidea  
Index des marques

Markenverzeichnis  
Índice de marcas  
Spis marek

FOR:	NAT.	PAG.
FECHADURA ®	BRASIL	47
FECOR ®		37, 446
FEDERAL ®	ESTADOS UNIDOS	47, 50, 127
FEFI ®		27
FEL ®		92
FEMSA ®		165, 168, 185, 191, 246, 256, 299, 310, 317, 320, 322, 325, 334, 335, 338
FERMABLOCK ®		82
FERMOD ®		35
FERONERIA ®	RUMANIA	47, 131
FERRARI ®	ITALIA	355225
FETIS ®	ESPAÑA	425
FF ®	ITALIA	47, 48, 131284
FH ®		453
FHUR ®		63
FIAM ®	ITALIA	374, 378, 425, 426
FIAT ®	ITALIA	187, 355
FIC ®	ESTADOS UNIDOS	48
FICHET ®	FRANCIA	17, 48, 68, 100, 115, 406
FINA ®		84
FINSTRAL ®		51282
FISAM ®		151, 184, 219, 249, 257, 319, 322, 325, 327, 331, 336, 341, 347
FIST ®	ITALIA	48, 347, 348
FIST ®		48, 150, 151, 157, 159, 166, 180, 183, 184, 187, 189, 190, 191, 193, 306, 228, 234, 246, 256, 296, 299, 301, 310, 320, 322, 323, 324, 325, 324, 331, 334, 335, 347, 348
FKS ®		42, 74, 101
FLAMBO ®		39, 15
FLIETHER ®		66
FLIK ®		51
FLOHR ®		48
FLOK ®		106
FLORA ®	ALEMANIA	48, 164, 284, 288, 289
FO ®		25, 8
FONTAINE ®	FRANCIA	48, 87, 110
FORCE ®		54
FORD ®	ALEMANIA	162, 166, 178, 183, 187, 189, 191, 194, 199, 200, 202, 200, 202, 223, 231, 232, 238, 246, 256, 269, 281, 285, 288, 294, 297, 302, 305, 307, 313, 355
FORINDEX ®		87
FORT ®	FRANCIA	12, 49, 61, 119, 146, 150, 154, 193, 196, 199, 200, 215, 236, 257, , 288, 290, 299, 303, 307, 309, 313, 320, 326, 350, 352
FORTE ®	VENEZUELA	49
FORTIS ®	ESPAÑA	49
FORTRESS ®		97
FOUR CIRCLE ®		120, 121
FOUSSIER ©		133
FPB ®		84
FRAL ®		84
FREA ®		150, 156, 165, 179, 184, 185, 188, 192, 218, 227, 233, 246, 256, 267, , 299, 318, 324, 325, 327, 332, 335, 338, 341
FRECOV ®		26

FOR:	NAT.	PAG.
FRIPA ®	ALEMANIA	374
FROSER ®		3, 85, 87, 150, 172, 175, 193, 230, 252, 260, 264, 274, 277, 298, , 307, 312, 314
FT ®		55
FTH ®	FRANCIA	3, 49, 50, 57, 99, 125, 127, 131, 138
FUCHS ®		33
FUHR ®		27
FULLEX ®		51
FULTON HITCH ®	REINO UNIDO	50222
GABON ®	FRANCIA	50
GAD ®	PAISES BAJOS	347
GAINSBOROUGH ®		71, 97
GALLUS ®		50
GAMET ®	POLONIA	51
GAMMA ©		137
GAON ®		65
GARDIAN ®	RUSIA	427
GARI ®		7
GAS ®		197, 253, 261, 287
GATO ®	COLOMBIA	51
GAZ ®		242, 282, 284, 295
GBS ®		116
GBZ ®	ITALIA	51229
GE GE ®	AUSTRIA	6, 9, 21, 44, 51, 52, 95
GEBA ®	ALEMANIA	18, 52
GEBRO ®		35
GEFI ®		5, 30, 31
GELBAU ®		97
GELBON ®		183, 250, 257, 258, 262, 276
GEM ®		146, 326
GEMINI ®		133
GEMM ®		67
GENERAL MOTORS ®		155, 160, 203, 204, 206, 207, 208, 209, 210, 211, 212, 213, 220, 221, , 225, 248, 304, 314
GERA ®	ALEMANIA	32, 52, 90, 95, 133, 374
GERDA ®	POLONIA	43, 52, 53, 128, 131, 133, 136, 141
GERION ®	RUSIA	427
GETE ®		5, 30, 31
GEVY ®	GRECIA	126, 129, 131, 137
GEWIRU ®		40
GEWU ®		342
GHE ®		151
GIBBONS ®	REINO UNIDO	53
GIESCHE ®		27, 66
GIESSE ®		109
GIMAST ®	ITALIA	427
GIMN ®		87
GIOBERT ®		150, 156, 157, 158, 165, 171, 173, 179, 184, 185, 188, 192, 218, 227, , 233, 246, 256, 267, 282, 293, 299, 318, 320, 322, 323, 324, 325, 338, 341, 354, 355, 356
GIPIS ®	ITALIA	427
GIUSSANI ®	ITALIA	53
GIVI ®		326
GLAZIEV ®	RUSIA	53
GLOBE ®	TAIWÁN	53, 54
GLOSTAL ®		51311
GMB ®	CHINA	54, 125, 132

FOR:	NAT.	PAG.
GMC ®	ALEMANIA	355
GMG ®	ITALIA	428
GODREJ ®	INDIA	54, 132
GOLD DOOR ®		54
GOLLOT ®		87
GOTZ ®		66
GOYAL ®		7
GPZ ®	RUSIA	406
GR ®	TAIWÁN	54
GRAF ®		66
GRAYHILL ®		61
GRUNDMANN ®		51
GSA ®		25
GTV ®	ALEMANIA	5, 30, 31, 55, 63
GUARD ®	HONG KONG	55, 59
GUARDIAN ®	REINO UNIDO	25, 57, 407, 427
GUERVILLE R. ®	FRANCIA	55
GUIDOTTI ®		87
GUITTEL ®		4, 5, 346
GUSHENG ®	ALEMANIA	55
GUTLER ®		92
H.R.S. ®		98
HÄFELE ®	ALEMANIA	26, 27, 37, 55, 56, 68, 69, 151, 173, 250, 262, 297, 302, 306, , 312, 314, 342, 348
HAGA ®	TAIWÁN	56
HAHN & KOLB ®	ALEMANIA	56
HAIDE ®		120, 121
HALLE ®	ESTADOS UNIDOS	56
HAMA ®		195
HAMPTON ®		102
HANNO ®		26
HARKOV ®	RUSIA	56
HARLEY DAV. ®		326
HARLOC ®	ESTADOS UNIDOS	56, 97, 313
HASLER ©		138
HAYWORTH ®	ESTADOS UNIDOS	56
HB ®	ITALIA	132
HBC ®		77
HEAD ®		120, 121
HEGO ®		32
HEKNA ®	ALEMANIA	37, 39, 56
HELCO-KFV ®	ALEMANIA	374, 375
HELIX ®	TAIWÁN	56, 119, 154, 303, 350, 352
HEMA ®		110
HEMY ®		120, 121
HENDERSON ®	REINO UNIDO	56, 57, 407
HERACLES ®		50, 14
HERME ®	TAIWÁN	57
HERMES ®		120, 121, 255
HERO ®		82
HERPE ®		97
HERSEE ®		306, 351
HESTE ®		32
HEWY ®		22
HFM ®	ALEMANIA	57
HILLMANN ®		98
HINO ®		280, 352

FOR:	NAT.	PAG.
HK ®		150, 193, 196, 199, 200, 215, 236, 257, 284, 288, 290, 299, 307, 309, 320
HOBBY ®		130
HOBES ®	REPÚBLICA CHECA	57, 407
HOHRMANN ®		18, 27, 37, 51
HOK ®	TURQUÍA	57, 132, 136
HOLDEN ®	ALEMANIA	355, 356
HONDA ®		152, 155, 156, 214, 215, 265, 281, 327, 328, 329, 331
HOOPLY ©		142
HOPPE ®		22
HORSE ®	TAIWÁN	57
HRG ®		82
HSA ®		66
HTEC ®	ESPAÑA	57, 132
HTV ®	REINO UNIDO	57, 92
HUDSON ®	ESTADOS UNIDOS	57, 213, 221, 225, 233, 291, 297, 298, 303, 315, 351
HUF ®		153, 154, 155, 162, 163, 164, 170, 177, 197, 207, 212, 232, 238, 248, , 269, 284, 285, 287, 289, 290, 298, 301, 307, 310, 313, 314, 320, 329, 331, 355, 357
HUGO ®	ALEMANIA	57, 127, 132
HUNIT ®	ITALIA	57
HUTRA ®		91
HUWIL ®	ALEMANIA	37, 57, 58, 132, 246
HYMER ®		130
HYUNDAI ®		215, 216, 217, 218, 226, 240, 270
I.R. ®		117
IACAM ®		246, 3
IBEAR ®	ESPAÑA	58
IBFM ®		30, 97, 98, 117, 131, 137, 347
ICA ®	ESPAÑA	58
ICSA ®	ITALIA	58, 135
IDEAL ®		37429
IDEAL SECURITY ®		115
IDM ®	ITALIA	428
IFAM ®	ESPAÑA	49, 58, 59, 98, 126, 128, 131, 132, 139
IFOS ®		97, 98
IGS ®	FRANCIA	59
IKON ®	ALEMANIA	35, 59, 60, 61
ILARGI ®	ESPAÑA	26, 61
ILCO ®	ESTADOS UNIDOS	61
ILLINOIS ®	ESTADOS UNIDOS	29, 61, 119, 306, 351
ILS ®	ITALIA	61
IMB ®	KUWAIT	61
IMBAC ®		86
IMP ®		3, 4, 5, 346
IMPAR ®		137, 14
IMSA ®		151, 159, 166, 180, 183, 184, 187, 189, 190, 191, 193, 226, 228, 234, , 256, 269, 271, 274, 282, 294, 296, 301, 309, 323, 324, 331, 334, 335, 347, 348
INCECA ®	ESPAÑA	146
INDAUX ®		12
INGERSOLL ®	ESTADOS UNIDOS	61
INLOC ®		20



Índice de marcas  
Marken aurkibidea  
Index des marques

Markenverzeichnis  
Índice de marcas  
Spis marek

FOR:	NAT.	PAG.
INSTALL ®		98
INT ®	ALEMANIA	61
INTHER ®	ESPAÑA	132
IR ®	FRANCIA	132
ISEO ®	ITALIA	3, 62, 110, 127, 132, 133, 138, 140, 141, 154, 375, 409, 426, 428
ISEO SILVER ®		62
ISKU ®		82
ISSERSTEDT ®		32
ISUZU ®	JAPÓN	62, 222, 304, 305
ITAL ®	ITALIA	429
ITEM ®		23294
ITO ®	TURQUIA	5, 30, 31, 62, 133
IVANA ®	ALEMANIA	62
JARDI ®	ESPAÑA	62, 63
JD ®		9, 88
JET ®		3
JINLONG ®	TAIWÁN	63
JIP ®	ESPAÑA	63, 85, 87
JIS ®	ESPAÑA	63, 134
JJ ®		35
JL ®		49
JMP ®		3, 5
JNF ©	PORTUGAL	133
JOHN DEERE ®		324
JOLI SAFE ®		103
JOMA ®	ESPAÑA	25, 58, 59, 63, 93
JORE ®		115, 116
JOSTA ®		26
JOVI ®	ESPAÑA	7, 63
JOWIL ®	ALEMANIA	55, 63, 64
JPM ®	FRANCIA	3, 30, 64, 134, 407
JTF ®	FRANCIA	64
JU ®		69, 111
JU JUNGINGER ®	ALEMANIA	64
JUGODENT ®		162, 166, 178, 187, 189, 191, 194, 223, 225, 231, 232, 256, 269, 281, 313
JUNGHEINRICH ®	ALEMANIA	64
JUNGST ®		63
JUNIE ®	ALEMANIA	64
JUNKUNC ®	ESTADOS UNIDOS	64, 65
JUWEL ®	ITALIA	429, 43
JUZU ®	ESPAÑA	65
JVAL ®	PORTUGAL	65
K+K ®		76, 29
KABA ®	SUIZA	133, 134
KABS ®	ALEMANIA	65
KALE ®	TURQUIA	3, 65, 134, 430
KALUGA ®	RUSIA	65
KAMAZ ®		151
KAP ®	RUSIA	65
KARDEX ®		26, 87
KARO ®		131, 294
KASSBOHRER ®		151
KASSEL ®	ITALIA	430
KATE ®		92
KAWASAKI ®		217, 321, 323, 329, 330, 340
KAWE ®		32, 33, 97, 115
KAZAN ®	RUSIA	65, 66

FOR:	NAT.	PAG.
KEMEN ®		7
KENWORTH ®	ESTADOS UNIDOS	66, 221, 225, 226, 233, 348
KERBEROS ®	RUSIA	431
KESO ®	SUIZA	134, 135
KEYA ®		3, 146, 150, 193, 230, 274
KFV ®	ALEMANIA	66, 131
KIA ®		198, 217, 226
KICHINEV ®	RUSIA	66
KIFER ®		7
KIFERM ®	FRANCIA	66, 68, 69, 86, 151, 173, 183, 250, 262, 264, 266, 274, 277, 285, 297, 302, 306, 311, 312, 314, 335, 342, 348
KIMA ®		27
KIND ®		22, 26
KIROVMACH ®	RUSIA	66
KITTY ®		2
KLIT ®		110, 154
KN ®		164, 284, 288, 289
KNAPP ®		26
KOLB ®		157, 162, 177, 194, 197, 199, 200, 202, 223, 239, 246, 265, 273, 284, 302, 340, 351
KOMATSU ®		352
KP ®	RUSIA	66
KRAMATORSK ®	RUSIA	66
KREMENCHUG ®	RUSIA	67
KREPISH ®	RUSIA	431
KRESTI ®	RUSIA	375, 376, 335
KROST ®		24
KTM ®		317, 318, 326, 327, 329, 331, 334, 335, 341, 342, 345
KUNERT ®		30, 347
KURZEME ®	RUSIA	431
KVR ®		25
KWIKSET ®	ESTADOS UNIDOS	67
KYMCO ®		331
KYNNARPS ®	REINO UNIDO	67
KYR ®		138
LABOFA ®		51
LADA BAKONY ®		227, 241, 242
LAFONTE ®	BRASIL	67
LAGRANDE ®		61
LAMA ®		78, 99, 321
LAMPA ®		26
LANCIA ®	ITALIA	356
LANE ®		34
LAPERCHE ®	FRANCIA	25, 67, 68, 87, 88, 110, 135, 407, 408
LAPORTE ®	FRANCIA	68, 153, 157, 236, 301, 306, 351
LAR ®	ESPAÑA	408, 444, 445
LAREDO ®		50, 118
LARK ®	TAIWÁN	53, 68
LAS ®	FRANCIA	68, 69, 86, 151, 173, 250, 262, 276, 297, 302, 306, 311, 312, 314, 342, 348
LASBOLAGET ®	SUECIA	69, 92, 133, 134, 408
LEFEBURU ®		29
LEGALLAIS ®	FRANCIA	69, 126, 132
LEGGIE ®	REINO UNIDO	69230

FOR:	NAT.	PAG.
LEHMANN ®		79, 80, 137
LEN-LOK ®		71
LEROY MERLIN ©		133
LEXUS ®		207, 231, 236, 280
LG ®		12
LINCE ®	ESPAÑA	9, 69, 70, 135, 431
LINDE ®		152, 164, 284, 288, 289
LION ®		64, 65
LIONA LIOX ®		87
LIPS ®	PAÍSES BAJOS	70, 85
LISTA ®		37
LITTO ®	BÉLGICA	10, 32, 70
LM ®		97
LML ®		154, 317, 318, 321, 323, 326, 329, 333, 336, 339, 341, 345, 349
LMP ®		183, 250, 257, 258, 262, 276
LOB ®	POLONIA	71, 121, 136, 140, 143
LOCK ®	MÉXICO	3, 71, 346
LOCK-IT ®	REINO UNIDO	376
LOCKSYS ©		138
LOCKWOOD ®	ESTADOS UNIDOS	71
LOGO ®	ITALIA	71, 72, 109
LORI ®		56
LOTUS ®		120, 121
LOWE & FLETCHER ®	REINO UNIDO	43, 49, 72, 73, 74, 146, 164, 169, 171, 181, 195, 202, 220, 223, 232, 234, 247, 265, 274, 282, 296, 301, 303, 319, 326, 339, 348
LT ©	CHINA	135
LUCKY ®	TAIWÁN	74
LUCO ®		54
LUMA ®	ESPAÑA	74
LUME ®		53
LUXOR ®		98
LYF ®	ESPAÑA	146
M&D ®		36, 128
M.LUNA ®		3
MACK ®		306
MACOR ®	ESPAÑA	448
MAFOR ®	FRANCIA	87, 377, 408
MAGNETI MARELLI ®		156, 157, 165, 185, 219, 228, 299, 320, 322, 323, 324, 325
MAGNUM ©	REINO UNIDO	135
MAKERSAN ®		168
MARC ®		74, 136
MARCADET ®		68, 348
MARIANI ®	ITALIA	74
MARK ®		102
MARQUES ®	PORTUGAL	74, 136, 348
MARS ®		42
MARUTI ®		233
MASTER ®	ESTADOS UNIDOS	33, 67, 74, 75, 136, 142
MASTER LOCK ®	CHINA	136
MASTERCRAFT ®		97
MATTEY ®		96
MAUER ®	PAÍSES BAJOS	36, 75, 128, 129, 136, 420
MAUSER ®		26
MAVE ®		409
MAXIGARD ®		50

FOR:	NAT.	PAG.
MAXIM ®	RUSIA	448
MAXUS ®	UCRANIA	75
MAZDA ®		199, 202, 234, 235, 236, 280
MBB ®		27
MCL ®	RUSIA	76
MCM ®	ESPAÑA	76, 77, 136, 408, 431, 432
MD ®		132, 133
ME FA ®	TAIWÁN	77
MECALUX ®		7, 37
MECO ®	ALEMANIA	77
MEDOS ®	POLONIA	77
MEGA ®	RUMANIA	57, 132, 136
MEGABLOCK ®		428
MELSMETALL ®	ALEMANIA	22, 77
MENOVA ®		37
MERCURE ®		68, 348282
MERCURY ®		351
MERIT LINDE ®		151, 152
MERKUR ®		63
MERMIER ®		32, 34
MERONI ®		25, 43, 77, 78, 146, 321
METAL ®	BULGARIA	78, 432
METALCASTELLI ®		56, 85
METALCHIMEX ®		98
METALUX ®	FRANCIA	78, 98, 110, 140
METEOR ®	ALEMANIA	18, 37, 69, 78
METIZ ®	RUSIA	78
METTEM ®		421
MG MONTI ®	ITALIA	78, 136
MHA ®	CHINA	137
MIA ®		438
MIAN ®		54
MIBRA ®		72
MICHEL SEAT ®	ITALIA	78, 83
MIGNON ®		118
MILA ®	DINAMARCA	78, 79
MILES ®	RUSIA	79, 46
MING TAY ®	TAIWÁN	79
MINI MOLA ®	PORTUGAL	377
MIRAGLIO ®		150, 156, 165, 179, 184, 185, 188, 192, 218, 227, 233, 246, 256, 267, 299, 318, 324, 325, 327, 332, 335, 338, 341, 0, 0, 0, 0, 0
MISCELLANEOUS ®		79
MITSUBISHI ®		167, 171, 180, 182, 213, 222, 241, 248, 303, 305, 308, 350, 351
MIWA ®	JAPÓN	79
MLM ®	ALEMANIA	37, 79, 80, 87, 96, 137
MOBELLA ®	SUECIA	80, 408
MODERN ®		110
MOFA ®		150
MOFLEX ®		82
MOGILEV ®	RUSIA	80263
MOIA ®	ITALIA	432, 448
MON ®	ESPAÑA	80
MONACOR ®		9
MONDIAL ®		55, 87, 152
MONOBLOC ®	FRANCIA	25, 8
MOREAUX ®		37, 87, 114, 129, 377
MOSKVA ®	RUSIA	409

Índice de marcas  
Marken aurkibidea  
Index des marques

Markenverzeichnis  
Índice de marcas  
Spis marek

FOR:	NAT.	PAG.
MOSKVITCH ®		242
MOSRENTGUEN ®	RUSIA	80
MOTTURA ®	ITALIA	80, 131, 137, 432, 433, 434, 435
MP ®	ITALIA	409
MP PLODARI ®	ITALIA	80
MR ®		97
MSM ®		80, 137
MST ®		25
MSV ®	PORTUGAL	81, 377
MUEL ®	FRANCIA	460
MUKRA ®		32, 33
MULTLOCK ®	ISRAEL	81, 137
NABOB ®	ISRAEL	377
NATIONAL CABINET ®	ESTADOS UNIDOS	81
NB ®		5, 30, 31, 48
ND ®		104, 140, 141
NEIMAN ®		152, 157, 159, 160, 161, 164, 173, 189, 215, 239, 250, 253, 258, 261, 265, 296, 301, 310, 314, 320, 323, 329, 331, 352
NEMEF ®	ALEMANIA	26, 27, 28, 32, 81, 87, 377, 453
NEWMAN TONKS ®		97
NICO ®		49, 66
NISSAN ®	JAPÓN	157, 179, 182, 218, 243, 245, 272, 304, 305, 309, 356
NOBO ®		37, 39
NOORI ©	ALEMANIA	137
NORDWEST ®		48, 91
NOVA ®	ALEMANIA	81, 101
NOVOFERM ®		32
NOXXA ®	PAÍSES BAJOS	81
NUMIDA ®		42, 87
O.M.R. ®		432
OAL ®		34, 53
OASA ®		409
OCARIZ ®	ESPAÑA	81
OCTAVO M. ®	RUSIA	81
ODA ®		10, 11, 29
OFITA ®	ESPAÑA	81
OIAUS ®		8
OJMAR ®	ESPAÑA	26, 81, 82, 137
OLIVA ®	ITALIA	82
OLIVETTI ®	ITALIA	82
OMA ®	ITALIA	82
OMEC ®	ITALIA	82, 83, 137, 435
OMIV ®	ITALIA	17, 83
OMR ®	ITALIA	78, 83, 448
ONIUM ®		106
OPEL-CHEVROLET ®		354, 355, 356
OPEL-VAUXHALL ®	RUMANIA	356
OPEL-VAUXHALL ®	ALEMANIA	356
OPSIAL ®		65, 134
ORBA ®		92
ORDO ®	FRANCIA	68, 79, 80, 83, 348
ORENGO ®	ESPAÑA	7, 409, 435, 445
ORION ®		97
ORION NOVOX ®	FRANCIA	83
ORLANDO ®		58
ORO ®	ISRAEL	83

FOR:	NAT.	PAG.
ORONA ®		370
ORSHA ®	RUSIA	83
OSKO ®		63
OSMET ®		409
OSTMARK ®	ALEMANIA	409
OTIS ®		59, 61
P&C.I. ®	ESTADOS UNIDOS	147
PADO ®	BRASIL	83
PANHARD ®		287
PANTHER ®		63
PAPAIZ ®	BRASIL	83, 84, 377
PAS ®		85
PASSEPARTOUT ®	FRANCIA	409
PASSY ®		86
PASTORE ®		85, 302
PATENT ®		409
PATRONE ®	ITALIA	435
PAYKAN ®		98
PB ®		82
PC ®	ITALIA	17, 65, 84, 147
PCO ®		71
PEBRA ®		168
PENT ©		140
PENZMASH ®	RUSIA	84
PERINO ®		409
PEROHAUS ®		39, 51, 64, 151
PERRIER ®		55
PETCO ®		67
PETERBORO ®		40
PETROZAVODSK ®	RUSIA	84
PEUGEOT ®	FRANCIA	356, 357
PFAFFENHAIN ®	ALEMANIA	84, 85
PGO ®		338
PH ®		141
PHILLIPS ®	MÉXICO	85, 127
PHOENIX ®	REINO UNIDO	85
PICARD ®	FRANCIA	17, 138
PICARDIE ®		50, 99, 139
PJ ®		69, 87, 150, 173, 175, 220, 250, 262, 266, 274, 277, 285, 289, 297, 306, 311, 312, 314, 342
PK ®		69, 173, 250, 262, 297, 302, 306, 311, 312, 314, 342
PLUS ®		4
PM ®		87
POLAR ®		180, 246, 273, 340
POLLAK ®		159, 257, 306, 315, 351
POLLUX ®	FRANCIA	85
PORTRISA ©		139
POS ®		151, 164, 284, 288, 289
POSSE ®		67
POTENT ®	ITALIA	78, 138, 435, 436
PP ®		35
PRAZIS ®		378
PREFER ®	ITALIA	82, 85, 86, 138, 436, 437, 448
PREMI ®		78
PRESTA®		20, 153, 236, 301, 306
PROAUTO ®		3, 150, 193, 230, 274
PROBAT ®		49

FOR:	NAT.	PAG.
PROGRES ®		48, 334
PROMO ®		85
PROTEC ®		25
PUCH ®		344
PZ ®		18, 19
QCM ®		35, 104
QCP ®		25
RADIAL ©		141
RAM ®		120, 121
RAUCO ®		56
REDY ®		71
REGAL ®	REINO UNIDO	86, 298
REGENT ®		56
REMO ®		58
REMOCON ©		141
RENAG ®	NORUEGA	409
RENAULT ®	FRANCIA	357
RENAULT DACIA ®	RUMANIA	357
RENZ ®	ALEMANIA	37, 68, 69, 86, 151, 215, 348
REVI ®	ESPAÑA	437
REX ®	DINAMARCA	86, 409, 410
RGM ®	ESPAÑA	86
RIAZIAN ®	RUSIA	86
RICOUARD ®	FRANCIA	86, 282
RIEJU ®		122, 154, 274, 317, 318, 319, 321, 322, 323, 324, 326, 329, 332, 333, 335, 336, 337, 338, 339, 340, 341, 345, 349
RIGA ®	RUSIA	86
RIGAL ®	RUSIA	437
RIL ®	ESPAÑA	86, 46
RIPA ®	ESPAÑA	59, 87
RITA ®		87
RITTAL ®		22, 23
RIV ®		104
ROC ®		50, 118, 246
RODES ®	PORTUGAL	87, 136
RONEO ®		7, 87, 112
RONIS ®	FRANCIA	67, 68, 74, 77, 87, 88, 153, 175, 234, 252, 257, 260, 264, 277, 306, 307, 312, 348, 377
ROOL A DOOR ®		15
ROOTES ®		171, 202, 274
ROS ®		183, 250, 257
ROSS ®		308, 309
ROSSETTI ©	ITALIA	138
ROTO ®		22, 52, 128, 134
ROYAL ®	TAIWÁN	4, 5, 88, 113, 120, 121, 346, 349
RS ®		82
RST ®		20
RUBEN ®	RUSIA	437, 445, 448
RUE ®	FRANCIA	445
RUFFINI ®		150, 156, 165, 179, 184, 185, 188, 192, 218, 227, 233, 246, 256, 267, 299, 318, 324, 325, 327, 332, 335, 338, 341
RUKA ®		37, 111
RUKO ®	DINAMARCA	88, 89
RUSSIA ®	RUSIA	89
RUSSWIN ®	ESTADOS UNIDOS	89

FOR:	NAT.	PAG.
RUTALCHI ®		7
SAAB ®		267
SABT ®	KUWAIT	89
SADV ®		21, 87, 175, 252, 260, 264, 277, 298, 306, 307, 312, 314, 258
SAFE ®	ITALIA	151, 159, 166, 180, 183, 184, 187, 189, 190, 191, 193, 226, 228, 234, 256, 269, 271, 282, 294, 296, 301, 309, 319, 323, 324, 331, 334, 335, 338, 347, 438
SAG ®		85, 423, 428
SAM ®	RUSIA	89, 90, 438
SAMSONITE ®	ESTADOS UNIDOS	90
SANCHUN ®		120, 121
SANEL ®		87
SANPEUR ®		112
SANTIS ®		26, 27
SANTOS ®		84, 137
SANY ®		9
SARGENT ®	ESTADOS UNIDOS	90
SATURN ®	ALEMANIA	90, 126
SCHARER ®	ESTADOS UNIDOS	87, 9
SCHLAGE ®	ESTADOS UNIDOS	15, 90, 91
SCHLECHTENDAHL ®	ALEMANIA	91
SCHLEGEL ®		37
SCHRITT ®		61
SCHUCO ®	ALEMANIA	3, 5, 30, 31, 66, 91
SCHURING ®		100
SCOVILL ®		15
SCUDO®		125
SE ®		55, 97, 139
SEA ®	SUIZA	138
SEAT ®	ALEMANIA	166, 173, 357, 178, 176, 187, 189, 191, 194, 218, 223, 225, 228, 256, 267, 268, 269
SECURE ®		94
SECUREMME ®	ITALIA	138, 438, 439
SECURIKEY ®		43, 77
SECURITAL ®	ITALIA	49, 138
SEEBURG ®		61
SEIMA ®		183, 250, 257, 258, 262, 276
SELECT ®	FRANCIA	91, 41
SELIVANOVSK ®	RUSIA	91
SEMEL ®		63, 95
SEN ®		66
SENTRY SAFE ®	ESTADOS UNIDOS	910
SERMEC ®	ITALIA	439
SERRALLER ®	ESPAÑA	7, 8, 35, 58, 124, 138, 139, 449
SERRETA ®	ESPAÑA	91, 46
SES ®		98
SESA ®		87, 88
SEZAN ®		120, 121
SHANGAI ®	TAIWÁN	92
SHAW ®	REINO UNIDO	92
SHAW WALKER ®	ESTADOS UNIDOS	92
SHERLOCK ®		54
SHILUTE ®	RUSIA	92

Índice de marcas  
Marken aurkibidea  
Index des marques

Markenverzeichnis  
Índice de marcas  
Spis marek

FOR:	NAT.	PAG.
SHOWA ®		90
SIAM ®		25, 92
SIAS ®	ITALIA	439
SIB ®		26, 135
SIBI ®	ITALIA	439, 449
SIDERAL ®	ITALIA	439
SIDESE ®	ESPAÑA	92
SIDLEEN ®		44
SIEBAU ®		27, 1
SIL ®		46, 93, 107
SIMATIC ®		92
SIMECA ®	SUIZA	53, 92
SIMPLEX ®		87, 156, 167, 169, 175, 224, 231, 240, 252, 260, 277, 299
SINJET ®		37
SIPEA ®		156, 165, 167, 179, 184, 185, 188, 192, 219, 227, 228, 233, 246, 256, 271, 296, 299, 310, 317, 319, 325, 336, 338
SIS ®	ITALIA	92
SISO ®	ITALIA	25, 44, 82, 93
SISPA ®		153, 188, 190
SJL ®	RUSIA	93
SKILMANN ®		33
SKODA ®	ALEMANIA	357
SMET ®		409
SOBINCO ®		25, 93
SOFER ®	PORTUGAL	93
SOFI SONAFI ®	PORTUGAL	93
SOLER ®	ESPAÑA	93
SOLID ®		27
SOLOR ®		88
SONICO ®		32
SOPRANO ®	BRASIL	93
SOS ®	FRANCIA	25, 50, 93, 98, 377
SP ®		131
SPEEDAL ®		26, 28
SPIDER ®	ISRAEL	138
SQUIRE & S. ®	REINO UNIDO	94
SS ®		27
SSANGYONG ®		270
STA LOCK ®	REINO UNIDO	94
STAM ®		47
STANDARD ®		5, 30, 31
STANDERS ®	ESPAÑA	127, 138
STAR ®	JAPÓN	94
STARLET ®	ALEMANIA	32, 95
STARRY LOCK ®		97
STEELCASE ®		29, 57
STEIGA ®		37
STEKLOMASH ®	RUSIA	95
STEM ®	ALEMANIA	95
STERLING ®	REINO UNIDO	95
STHALEX ®		97
STIQAM ®		25, 104
STIQUAM ®		409
STORWALL ®		92
STRAFOR ®		68, 87, 348
STRATTEC ®		196, 198, 201, 239, 302
STREBOR ®	REINO UNIDO	72, 95, 153, 169
STREMLER ®		20, 25, 32, 87, 110

FOR:	NAT.	PAG.
STS ®	ESPAÑA	24, 37, 95, 96, 130, 138, 139, 140, 183, 184, 349
STUBLINA ®	SERBIA Y MONTENEGRO	96
STUMPF ®	ALEMANIA	96
STUMPF METALL ®		82
STUV ®	ALEMANIA	26, 27, 37, 40, 79, 80, 87, 88, 96
STV ®		83, 137
SUBARU ®	JAPÓN	272, 273, 357, 358
SUF ®		49
SUKI ®		48
SUL ®		32
SUREX ®	FRANCIA	96
SURFINOR ®		48
SUYOKA ®		7
SUZUKI ®		208, 213, 223, 233, 275, 319, 321, 329, 330, 332, 336, 338, 340
SWAN ®		120, 121
SWEDA ®		85
TAITO ®	JAPÓN	96
TALLINN ®	RUSIA	96, 97
TANLOCKS ®		69
TAP-AGIS ®		154
TARONI ®	ITALIA	139
TAS ®		17
TATA ®		233, 277
TAYLOR ®	ESTADOS UNIDOS	95, 97
TAYMOR ®		97
TECHNAL ®		97
TECHNO ®	ALEMANIA	97
TECHPRO ®		140
TECNO ®		58, 106
TECNOLAR ®		139
TECNOR ®		48
TECON ®	ESPAÑA	97, 139
TECSESA ®	ESPAÑA	139, 439
TECUMSEH ®		352
TEICOCIL ®	PORTUGAL	97, 101, 101, 131, 279
TEKA ®	SUECIA	12, 97
TELFORD ®		72, 195, 348
TEM ®	ESPAÑA	58, 59, 97
TERCA		124
TESA ®	ESPAÑA	3, 58, 62, 97, 98, 113, 132, 139, 140, 349, 372, 410
TESIO ®	ITALIA	33, 44
TESTA ®		25
TH ®	ALEMANIA	98276
THIRARD ®		49, 50, 127, 131
THOMAS LAIDLAW ®		139
THONE ®		32
THT ®		132
TIBBE ®		168, 178, 223
TICINO ®	ITALIA	98
TIEFENTHAL ®		41, 55, 63
TIFON ®	TAIWÁN	98
TIGRIS ®	REINO UNIDO	98
TITAN ®	ESLOVENIA	67, 98, 99, 104, 140, 141, 154, 343
TITANO ®	ITALIA	440
TITUS ®		117
T-KEY ®	CHINA	99, 14

FOR:	NAT.	PAG.
TM ®		37
TOK WINKHAUS ®	ALEMANIA	17, 99, 100, 101
TOKAJ RIKA ®		154, 167, 178, 179, 206, 207, 208, 214, 217, 223, 232, 275, 276, 278, 280, 281, 304
TOMSK ®	RUSIA	101
TOOL BOX ®		
TOP ®	ALEMANIA	81, 101
TOPLOCK ®		137, 14
TOUCH ®	REINO UNIDO	101
TOVER ®	ESPAÑA	101, 126, 131, 140, 440
TOY ®		146
TOYOTA ®		154, 167, 178, 179, 206, 207, 214, 217, 223, 232, 236, 267, 273, 275, 278, 279, 280, 281, 285, 304
TR ®	ITALIA	440
TRAMA ®		185, 227, 246, 256
TRAVEX ®	PERÚ	101, 31
TREE ®		31
TRELOCK ®	ALEMANIA	99, 100, 101, 102, 111, 154, 349
TRI STAR ®	TAIWÁN	102
TRI-CIRCLE ®	TAIWÁN	40, 102, 103
TRIMARK ®	ESTADOS UNIDOS	103
TRINITY ®		79
TRIO-VING ®	NORUEGA	103, 372, 410, 411, 296
TRITON ®		27, 63
TRIUMPH MOTORCYCLE ®		342
TROMER ®		136
TRUMPH ®		98
TRUPER ®	ESTADOS UNIDOS	104
TRW-SIPEA ®		155, 159, 171, 173, 229
TRYBA ®		44
TSAG ®	ESPAÑA	147181
TSC ®		44
TUFF ®	HONG KONG	377, 378391
TULA ®	RUSIA	104
TURSAN ®		65
TURSCHLOSS ®		17
TUSHINO ®	RUSIA	104, 44
TUTIS ®		41
TZAFRER ®	REINO UNIDO	30, 51, 104
UBE ®		155, 163, 164, 197, 255, 269, 284, 286, 287, 288, 289, 290, 298, 301, 313, 314
UCEM ®	ESPAÑA	35, 104, 112, 140, 141, 411
ULIANOVSK ®	RUSIA	104, 105
ULTION ®		127
ULTRA ®		72, 73, 348
UMF ®	PORTUGAL	105
UNIFOR ®		85
UNION ®	REINO UNIDO	72, 105, 106, 163, 165, 168, 169, 220, 224, 231, 240, 267, 281, 292, 302, 312, 319, 320, 337, 348, 349, 412
UNIPART ®		WAS-8 GILTZA
UNIVERSAL		106, 107, 108, 109, 110, 141, 378
URBIS ®	RUMANIA	110, 141
URKO ®	ESPAÑA	110, 46
US ®		64341
U-SHIN ®		252, 280, 355, 356, 357, 358

FOR:	NAT.	PAG.
UTZ ®		72, 92
VACHETTE ®	FRANCIA	67, 68, 99, 100, 110, 111, 112, 131, 132, 133, 141, 154, 161, 172, 182, 233, 260, 262, 264, 277, 299, 312, 412, 445, 446, 453
VAGO ®		85
VARIOUS BRANDS		112, 346, 347, 348, 349, 358, 370, 384, 385, 386, 387, 388, 389, 390, 392, 393, 394, 395, 396, 397, 398, 399, 400, 401, 412, 441, 442, 445, 446, 453, 456, 457, 458, 460
VAUGHN ®		92
VBH ®	ALEMANIA	16, 99, 113, 131
VDO ®		151
VEGA ®	FRANCIA	11, 87, 113
VELO ®		120, 121
VENDI ®	RUMANIA	113
VENLOCK ®		97231
VERA ®		90337
VERSCO ®		32
VESPA ®		344
VF (VEROFER) ®		47, 131
VGF VILLATORE ®	ITALIA	113
VIDMAR ®		138
VIKI ®		37
VILLFER ®	ESPAÑA	446
VINCO ®		110, 111
VING ®	NORUEGA	113
VIP ®		25312
VIRO ®	ITALIA	2, 113, 114, 142, 154, 317, 318, 321, 323, 326, 329, 333, 336, 339, 345, 349
VISO ®		120, 121
VISONIC ®		9
VOKO ®		26, 63
VOLGA ®		242, 282, 283, 284, 295
VOLGOGRAD ®	RUSIA	114
VOLKOVYSK ®	RUSIA	114
VOLKSWAGEN ®	ALEMANIA	358
WALE ®		117, 118, 127
WALLY ®	TAIWÁN	114
WALRUS ®	TAIWÁN	114
WANJIN ®	CHINA	142310
WASO ®		26, 150, 166, 187, 189, 191, 193, 194, 196, 199, 200, 215, 223, 225, 236, 243, 244, 245, 256, 257, 269, 281, 284, 288, 290, 294, 299, 307, 309, 313, 320
WBH ®		106, 163, 169, 214, 220, 224, 225, 231, 240, 267, 282, 292, 292, 302, 349
WEBER ®	ALEMANIA	115
WEBSTER ®	REINO UNIDO	115
WECO ®		18, 26, 115, 118, 151
WEDO ®		42
WEISER ®	ESTADOS UNIDOS	46, 115
WELKA ®	ITALIA	115, 44016
WEPA ®		63
WESCO ®		164, 284, 288, 289
WESLOCK ®	ESTADOS UNIDOS	115

Índice de marcas  
Marken aurkibidea  
Index des marques

Markenverzeichnis  
Índice de marcas  
Spis marek

FOR:	NAT.	PAG.
WEST ALLOY ®		105, 163, 165, 168, 169, 220, 224, 231, 240, 267, 281, 292, 296, 302, 319, 320, 349
WEST LOCK ®	ESTADOS UNIDOS	115, 352
WHITCO ®	AUSTRALIA	115
WIGRO ®		115, 116
WILKA ®	ALEMANIA	115, 116, 142, 249
WILLENHALL ®		53
WILMOT BREEDEN ®		178, 195, 223, 281, 303
WINFIELD ®		120, 121
WINKHAUS ®	ALEMANIA	100, 117
WINLOCK ®	REINO UNIDO	117332
WINNER ®		50, 55
WIREROPE ®	HONG KONG	117
WITTE ®		155, 163, 164, 197, 255, 256, 269, 284, 288, 289, 290, 298, 301, 307, 313, 314, 355
WMS ®	REINO UNIDO	117, 412
WOC ®		50, 118
WSM ®		22
WSS ®		56, 88
WT ®	CHINA	42, 117
WÜRTH ®		56, 58
YAC ®		87
YALE ®	REINO UNIDO	18, 19, 31, 50, 66, 92, 117, 118, 119, 120, 138, 142, 150, 154, 170, 171, 180, 181, 202, 207, 224, 225, 254, 255, 264, 265, 284, 286, 287, 306, 351, 378, 412, 440, 441, 460
YALTRES ®		127, 131
YAMAHA ®		276, 293, 341, 343, 344, 345
YANEDIS ®		42
YARD ®		121
YARDENI ®	ISRAEL	121, 143
YEMAR ®		140, 141
YETI ®	TAIWAN	71, 120, 121, 136, 143
YMOS ®		153, 163, 170, 176, 177, 183, 195, 198, 202, 213, 221, 208, 221, 248, , 268, 283, 284, 288, 289, 299, 305, 307, 309
YUGO ®		294
YUN HUAN ®	CHINA	121
YVEL ®		86
YWS ®	TAIWÁN	122
ZADI ®	ITALIA	122, 151, 154, 284, 317, 318, 319, 321, 322, 323, 324, 326, 327, 329, , 333, 334, 335, 336, 337, 338, 339, 340, 341, 342, 345, 349
ZAIN ®		14, 126
ZANI ®		58
ZAZ ®		242, 282, 284, 295
ZECE ®		32
ZEISS IKON ®	ALEMANIA	59, 60, 61, 378, 379
ZENI ®	REINO UNIDO	25, 122
ZENICA ®		25
ZENITH ®		25, 92
ZIL ®		151, 284
ZILTEN ®		131
ZUNDAPP ®		342

FOR:	NAT.	PAG.
------	------	------



**JMA\Headquarters**

ALEJANDRO ALTUNA, S.A.  
Bidekurtzeta 6, P.O.Box 70, 20500  
Arrasate-Mondragon, Gipuzkoa. Spain

**www.jma.es**  
ventas@jma.es  
+34 943 793 000

**JMA\France**

Technoparc  
13, rue Charles-Edouard Jeanneret  
F- 78306 Poissy Cedex

**www.jmafrance.fr**  
service.commercial@jmafrance.fr  
+33 01 39 22 42 10

**JMA\Maroc**

JMA MAROC S.A.R.L.  
83,85 Bd Oued ZIZ, El Oulfa  
Casablanca  
Marruecos

**www.jma.ma**  
jma@jma.ma  
+0520 150 535

**JMA\Mexico**

LLAVES ALTUNA DE MEXICO S.A de C.V  
Av. Aviación No. 5520  
Col. San Juan de Ocotán  
C.P. 45019 Zapopan, Jalisco

**www.jma.com.mx**  
ventas@jma.com.mx  
+52 33 3777 1600

**JMA\Colombia**

IFAM - JMA COLOMBIA S.A.S.  
Parque Empresarial Oikos La Florida  
Autopista Medellín KM 2, Bodega 05  
Bogotá

**www.jmacolombia.com**  
info@jmacolombia.com  
+57 3188088314

**JMA\Perú**

JMA Perú S.A.C.  
Av. Los Paracas 130, Urbanización  
Salamanca,  
Distrito Ate, Lima

**www.jma-peru.com**  
info@jma-peru.com  
+51 639 9300

**JMA\Polska**

JMA POLSKA Sp. z.o.o.  
91-342 Łódź, ul. Zbąszyńska 3

**www.jmapolska.pl**  
biuro@jmapolska.pl  
+48 42 635 12 80

**JMA\Portugal**

ALTUNA PORTUGAL, COMERCIO DE  
CHAVES UNIPessoal, LDA.  
Urbanização dos Areiros, Lote 67 C/v  
2695-733 São Joao da Talha

**www.jmaportugal.com**  
comercial@jmaportugal.com  
+351 219 947 470

**JMA\Uk**

SKS LTD  
Unit 2, Canalside Northbridge Road  
Berkhamsted  
Herts HP4 1EG

**www.jmakeys.co.uk**  
sales@skskkeys.co.uk  
+44 144 229 1400

**JMA\USA**

ALTUNA GROUP USA INC.  
1513 Greenview Dr  
Grand Prairie, Texas.  
USA. 75015

**www.jmausa.com**  
info@jmausa.com  
+1 817 385 0515



JMA E-training



JMA E-shop

**Opening  
the future**

Member of  
**Altuna Group**



**JMA**<sup>®</sup>