

CATÁLOGO GENERAL

GENERAL CATALOGUE

CATALOGUE GÉNÉRAL



Metalurgia Pons.LIM, S.L.

Fabricación de cerraduras, bisagras, pernios y herrajes
Production of locks, hinges, butt hinge and fittings
Production de serrures, charnières, gons et ferrures

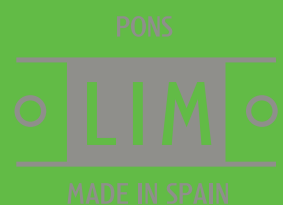

Una gran compañía para un pequeño producto

A large company for a small product

Une grande société pour un petit produit

"PONS LIM" es una marca creada en 1925 que actualmente fabrica y comercializa Metalurgia Pons. LIM, S.L.

En estos años la compañía se ha posicionado como una de las pocas empresas europeas de mayor especialización en la fabricación de bisagras y herrajes para muebles, construcción, estuchería, náutica, etc.

Producimos más de 1.000 referencias y hay más de 10.000 combinaciones posibles entre sus variantes.

Nuestro nivel técnico y productivo nos permite desarrollar nuevos productos según las necesidades del cliente.

Actualmente los productos LIM se distribuyen a más de 40 países, principalmente en Europa, América y Emiratos Árabes.

"PONS LIM" is the brand produced and commercialized by METALURGIA PONS.LIM, S.L., since 1925.

The company has positioned itself as one of the few European firms specialized in the manufacture of hinges and fittings for furniture, construction, household items, luggage making, navigation, toilet cubicles, etc.

We produce more than 1.000 references and there are more than 10.000 possible combinations. Besides these, as manufacturers, we do also develop new products as per customer's specific needs, custom-made products.

Nowadays our products are distributed in more than 40 countries, mainly in Europe, the Americas and United Arab Emirates.

"PONS LIM" est une marque fabriquée et commercialisée par METALURGIA PONS.LIM,S.L., dès 1925.

La société est devenue l'une des rares entreprises européennes spécialisées dans la fabrication de charnières et ferrures pour meubles, pour la construction, pour cabines sanitaires, construction navale, etc.

On fabrique plus de 1.000 références et plus de 10.000 combinaisons sont possibles.

En plus de ceux-ci, on fabrique des produits sur mesure.

Actuellement les produits LIM sont expédiés dans plus de 40 pays, principalement en Europe, l'Amérique, et des Émirats Arabes.





Diseño y desarrollo de moldes - *Tooling design and development* - Conception et développement des outillages

Fabricamos sus productos a medida

Gracias a nuestro completo sistema de producción, somos capaces de fabricar, además de todos nuestros productos de catálogo, productos a medida para nuestros clientes.

Todos nuestros departamentos, desde el de diseño, de fabricación de moldes, de producción, y hasta el departamento de logística forman parte de una potente estructura de fabricación que permiten triangular la calidad con el precio y el buen servicio.

Disponemos de las últimas tecnologías y métodos de producción, con una amplia posibilidad de acabados y tratamientos superficiales: galvanización, electrolisis, pintados, acabados estéticos, etc.

We produce Custom-made products

Because of our high tech production system and thanks to our committed team, besides the articles in general catalogue, we can also produce custom made products. Whatever your requirements are, we will bring them in.

Feel free to send us your samples and/or drawings, so we can work out an offer for you.

Moreover, we design and produce our own tool, which helps us meet deadlines.

Forward us your inquiry and we'll be happy to send you an offer.

Nous fabriquons des produits sur mesure

On peut fabriquer exactement les charnières dont vous avez besoin.

D'après vos plans, vos explications ou des échantillons, nous vous livrerons vos produits. Toujours dans des courts délais, car c'est nous-mêmes qui concevons et fabriquons nos propres outillages.

Contactez-nous, nous serons heureux de vous faire parvenir une offre en fonction de vos exigences.

Ferias - Fairs - Foire



Marcaje CE

En Metalurgia Pons.LIM,S.L ya disponemos de algunos modelos con marcado CE (Certificado de conformidad UNE-EN 1935:2000). Actualmente la referencia 135 de nuestro catálogo.

CE marking

By Metalurgia Pons. LIM, S.L., CE, UNE-EN 1935:2002 certified products are already available. Currently our reference 135

Marquage CE

À Metalurgia Pons.LIM, S.L., nous avons déjà disponibles quelque modèles avec le marquage CE, UNE-EN 1935:2002. Actuellement, nous l'avons dans la référence 135 de notre catalogue.



Sistema gestión de calidad

Desde el año 2000, en Metalurgia Pons. LIM, S.L. contamos con el Certificado de Calidad conforme con las exigencias de la Norma ISO 9001. Éste implica la garantía de que el Sistema de Gestión para la fabricación y comercialización de nuestros productos se realiza con la eficacia y eficiencia que exigen nuestros clientes.

Quality management system

Since year 2000, our Management System is in accordance with ISO 9001 Standard, certified by Bureau Veritas. This guarantees that the manufacturing and marketing of our products is done with the efficiency and effectiveness by our customers required.

Systeme de gestion de la qualité

Depuis l'année 2000, notre système de gestion est conforme à la norme ISO 9001, certifiée par Bureau Veritas. Ainsi nous pouvons garantir à notre clientèle que nos procédés de fabrication et de vente sont basés sur la plus haute efficacité.



1. Ejemplo de descripción de un modelo
Model description example
 Exemple de description d'un modèle

Definición tipo de bisagras
Hinge type definition
 Définition de type de charnières

Medidas (alto x ancho x grosor)
Sizes (width x height x thickness)
 Mesures (largeur x hauteur x épaisseur)

Tipo de tornillo / clavo
Screw and nail type
 Type de vis et de clous

Ref. catálogo antiguo
Ref. old catalogue
 Réf. ancien catalogue

Ref. y código por medidas
Ref. and measurement code
 Réf. et code par mesures

nº de agujeros y diámetro
no of holes and diameter
 nombre d'orifices et diamètre

Nueva referencia
New reference
 Nouvelle référence

Alzado: ilustración del producto
Elevation: illustration of product
 Élévation: illustration du produit

Planta: ilustración del producto
View: illustration of product
 Étage: illustration du produit

Ref. 100 - Mod. 207

Ref./Cod.	mm Medidas / Inch Size Dimension	Agujeros x ø mm Holes Trou	Ø x Tornillo Screw Vis
100/001	25x25x0.8	4x2	2.5x12
100/002	30x30x0.8	4x3	2.5x12
100/003	35x30x0.8	4x3	2.5x12
100/004	40x35x0.8	4x3	2.5x12
100/005	50x35x0.8	6x3.5	2.5x12
100/006	50x40x0.9	6x3.5	2.5x12
100/007	60x35x0.9	6x4	3x16

Variantes / Variants / Variantes

Variantes con los que puede solicitar la misma referencia
Variants with which the same reference can be requested
 Variantes qui peuvent être demandés sous la même référence

Materiales -(Acabados) / Materials -(Treatments) / Matériaux -(Finitions)

H	(PU) - (ZI) - (LA) - (NI) - (BR) - (PA)
L	(PU) - (NI) - (SA)
I304	(B) - (SA)

Materiales y acabados con los que puede solicitar la misma referencia
Materials and finishes with which the same reference can be requested
 Matériaux et finitions qui peuvent être demandés sous la même référence

Forma de servicio: caja y nº de unidades
Service type: box and no of units
 Forme de service: caisse et nombre d'unités

2. Variantes / Variants / Variantes:

Estampadas / Full mortise / Ailes déportées



Planas / Flat / Ailes à plat



Tapabocas o codo / Half mortise / Bouchon



Elección del dentado / Key options / Clef options



Sin agujeros / Without holes / Sans orifices



Con agujeros / With holes / Avec orifices



Remates altos / High coping / Souches élevées

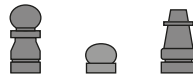

Remates chatos / Low coping / Souches plates

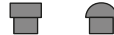

Desmontables / Can be dismantled / Démontables

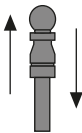

Bisagra izquierda / Left hinge / Charnière gauche



Bisagra derecha / Right hinge / Charnière droite



Cantos redondos / Round corners / Bouts ronds



Cantos cuadrados / Square corners / Bouts carrés



3. Materiales y acabados de las bisagras
Hinge materials and finishes
 Matériaux et finitions des charnières

	Materiales	Materials	Matériaux
H	Hierro	Iron	Fer
L	Latón	Brass	Laiton
I304	Acero Inoxidable 304	Stainless Steel 304	Acier Inox. 304
I316	Acero Inoxidable 316	Stainless Steel 316	Acier Inox. 316
I303	Acero Inoxidable 303	Stainless Steel 303	Acier Inox. 303
Z	Zamac	Zamac	Zamac
AL	Aluminio	Aluminium	Aluminium
PLAS	Plástico	Plastic	Plastique

	Acabados	Finishes	Finitions
(B)	Brillo	Bright	Brilliant
(BL)	Blanco	White	Blanc
(BR)	Cuero Bronce	Bronze Leather	Cuir Bronze
(BRI)	Bricomatado	Brico-Matt	Bricomaté
(CR)	Cromado	Chrome plated	Chromé
(CO)	Cobre	Cooper Plated	Cuivre
(CU)	Cuero	Leather	Cuir
(EP)	Electropulido	Electropolished	Électropoli
(GR)	Gris	Grey	Gris
(GRM)	Gris Mate	Matt Grey	Gris Mat
(LA)	Latonado	Brass Plated	Laitonné
(MR)	Marrón	Brown	Brun
(NG)	Negro	Black	Noir
(NI)	Niquelado	Nickel Plated	Nickelé
(NIM)	Niquelado Mate	Unpolished Nickel Plated	Nickelage Mat
(NIS)	Niquelado Satinado	Satin Nickel Plated	Nickelage Satiné
(NL)	Niquelado Latonado	Nickel and Brass Plated	Nickelé et Laitonné
(O)	Oro	Gold	Or
(PA)	Pavonado	Black oxide	Zingage noir
(PIBL)	Pintado Blanco	White Painted	Paint Blanc
(PIGR)	Pintado Gris	Grey Painted	Paint Gris
(PIMR)	Pintado Marrón	Brown Painted	Paint Brun
(PING)	Pintado Negro	Black Painted	Paint Noir
(PU)	Pulido	Polished	Poli
(PUE)	Pulido Espejo	Mirror Polished	Poli Miroir
(SA)	Satinado	Satin	Satiné
(ZI)	Zincado	Zinc Plated	Zingué

Todos los acabados con (.L) llevan un Lacado final / All the finishes with (.L) are Lacquered also / Toutes les finitions avec (.L) sont aussi Laquées

4. Diferencia entre bisagras derecha y bisagras izquierda
Difference between right hinges and left hinges
 Différence entre charnière droite et charnière gauche

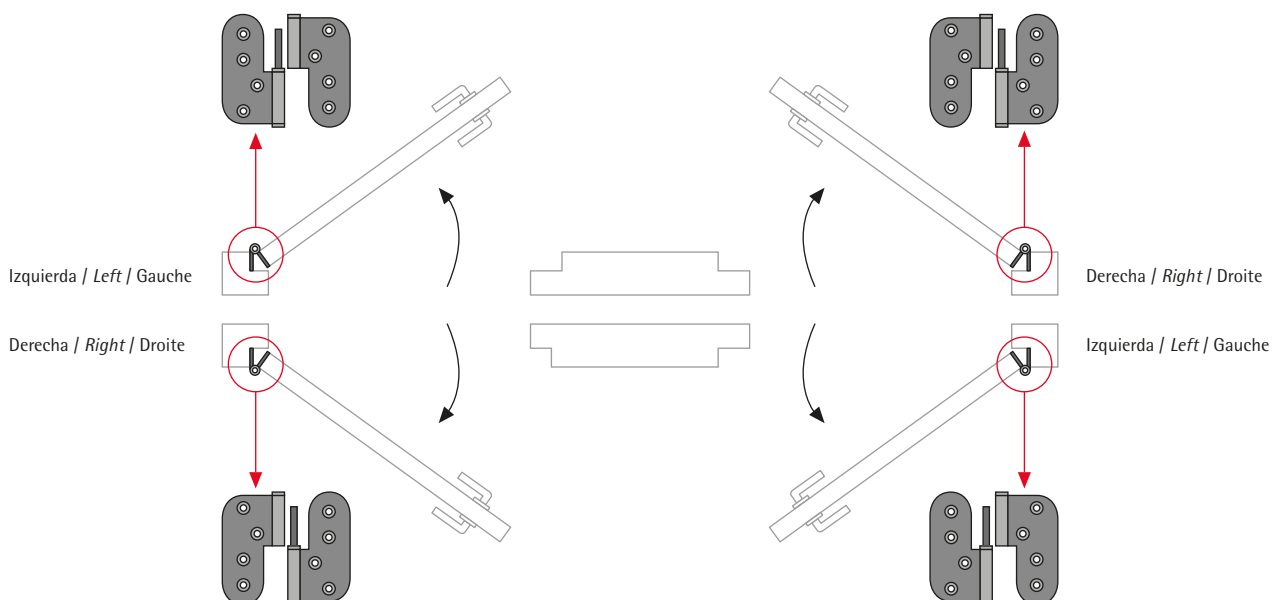

Índice de referencias por página - Reference per page - Références par page

Ref.	Pág.
13	168
14	170
16	169
19	163
20	150
23	124
30	144
31	142
38	108
47	124
50	158
54	42
59	120
61	43
69	123
71	144
72	142
73	146
74	159
78	43
78	59
80	159
85	159
88	168
92	155
93	149
100	14
101	14
102	15
103	16
104	18
105	15
106	16
107	16
108	23
109	17
110	17
111	34
112	56
113	60
114	56
115	43
115	59
116	60
117	56
119	20
120	85
121	20
122	18
123	18

Ref.	Pág.
124	19
125	19
126	22
127	30
128	30
128	31
129	19
130	21
131	21
132	21
132	60
133	29
134	30
135	28
135	29
136	29
137	84
138	84
139	84
139	85
139	218
140	46
140	47
141	47
141	67
142	67
143	49
143	52
144	53
145	55
146	40
147	41
148	40
149	89
149	90
149	132
150	91
150	133
151	91
151	133
152	38
152	194
153	31
153	218
154	86
155	89
156	90
156	133
157	33
158	85

Ref.	Pág.
159	33
160	87
160	89
161	62
162	62
163	62
164	50
165	64
166	64
167	62
168	24
169	24
170	23
171	23
172	34
172	35
172	36
172	37
175	66
181	32
181	57
181	58
188	74
188	75
193	74
193	75
193	76
198	71
199	79
200	22
201	78
202	78
203	80
204	79
206	121
207	121
208	24
209	24
210	164
211	146
212	80
212	147
213	147
214	116
215	150
216	150
217	143
219	37
219	147
220	86

Ref.	Pág.
221	148
222	148
223	148
224	148
225	190
226	123
226	191
227	120
227	190
227	191
227	192
227	193
228	123
228	191
229	38
229	194
230	38
230	194
231	38
231	194
232	38
232	194
233	178
234	178
235	178
236	179
237	179
238	195
239	179
240	180
241	180
242	180
244	183
245	183
246	183
247	183
250	182
251	182
252	182
253	186
254	177
255	185
256	185
257	185
258	182
259	181
260	218
260	219
261	187
261	219

Índice de referencias por página - Reference per page - Références par page

Ref.	Pág.	Ref.	Pág.	Ref.	Pág.	Ref.	Pág.
262	219	451	48	612	139	1500	105
263	32	455	164	613	141	1502	100
264	150	456	59	617	170	1503	103
320	179	457	78	619	127	1505	102
320	181	457	132	620	163	1505	103
325	171	458	64	622	127	1507	105
331	20	464	125	624	140	2000	106
332	88	464	126	625	163	3000	144
336	76	469	158	626	139	8000	107
342	149	469	161	627	160	9000	107
344	108	469	216	636	154		
356	68	470	51	653	141		
356	78	490	158	670	172		
356	129	496	64	671	173		
356	132	497	52	672	172		
356	134	500	171	673	173		
356	135	505	108	700	138		
357	158	505	112	711	63		
360	67	505	113	715	63		
364	114	505	114	716	63		
377	70	507	109	738	88		
377	86	524	32	749	115		
382	68	526	79	754	152		
382	217	533	87	754	153		
389	122	534	81	759	25		
389	215	536	23	759	26		
400	128	537	60	761	151		
432	135	575	68	764	118		
432	143	575	217	768	115		
440	112	590	31	771	165		
440	145	597	128	772	54		
440	209	600	26	880	121		
440	210	600	39	900	117		
440	211	600	122	1000	146		
440	212	600	198	1010	143		
440	213	600	199	1021	33		
440	214	600	200	1108	102		
440	215	600	201	1190	99		
440	216	600	202	1200	98		
440	218	600	203	1200	100		
446	81	600	204	1205	98		
446	97	602	119	1206	99		
446	177	603	162	1207	101		
446	181	607	139	1208	102		
446	184	608	138	1211	100		
446	185	609	140	1213	104		
446	186	610	94	1215	104		
447	71	610	95	1220	99		
447	72	610	96	1307	101		
449	117	611	140	1500	101		

1	<p>Bisagras <i>Hinges</i> Charnières</p>	<p>Pag.12-81</p>	
2	<p>Pernios <i>Lift-off hinges</i> Fiches et Paumelles</p>	<p>Pag.82-91</p>	
3	<p>Cerraduras y llaves <i>Locks and keys</i> Serrures et clés</p>	<p>Pag.92-109</p>	
4	<p>Accesorios para puertas y muebles <i>Accessories for doors and furnitures</i> Accessoires pour portes et meubles</p>	<p>Pag.110-129</p>	
5	<p>Carpintería metálica <i>Hinges and accessories for profiles</i> Charnières et accessoires pour profils</p>	<p>Pag.130-135</p>	
6	<p>Escuadras, placas, soportes y ensamblajes <i>Brackets, plates, supports and assemblies</i> Consoles, Équerres, plaques et supports</p>	<p>Pag.136-155</p>	
7	<p>Placas colgador, ganchos, perchas y asas <i>Hooks, hook plates, hangers and handles</i> Plaques pendeire, crochets, patères, poignées</p>	<p>Pag.156-165</p>	
8	<p>Compases y guías cajón <i>Lid/flap stay hinges and drawer slides</i> Charnière compas, glissières et coulisseau</p>	<p>Pag.166-173</p>	
9	<p>Estuchería (bisagras, cierres y accesorios) <i>Hinges and accessories for cases</i> Charnières et accessoires pour étuis</p>	<p>Pag.174-187</p>	
10	<p>Piezas Artesanales Menorquinas <i>Typical Menorca fittings</i> Ferrures typique minorquinas</p>	<p>Pag.188-195</p>	
11	<p>Herrajes para pérgolas <i>Fittings for pergolas</i> Ferrures pour pergolas</p>	<p>Pag.196-205</p>	
12	<p>Accesorios para Cabinas Sanitarias <i>Accessories for toilet cubicles</i> Accessoires pour cabines sanitaires</p>	<p>Pag.206-219</p>	

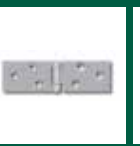

INOX. 316

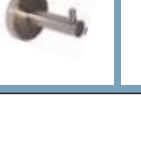
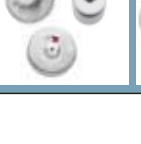
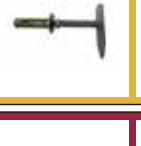
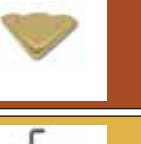
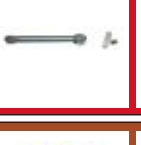
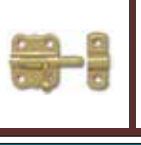
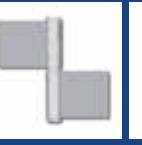



BISAGRAS PARA MUEBLES / *HINGES FOR FURNITURES* / CHARNIÈRES POUR MEUBLES PAG.14-26

BISAGRAS PARA LA CONTRUCCIÓN / *HINGES FOR CONSTRUCTION* / CHARNIÈRES POUR LA CONSTRUCTION PAG.27-39

BISAGRAS DE DOBLE HOJA / *DOUBLE SHEET HINGES* / CHARNIÈRES DOUBLE FEUILLE PAG.40-43

BISAGRAS DE PIANO / *CONTINUOUS PIANO HINGES* / CHARNIÈRE À PIANO PAG.44-55

BISAGRAS TIPO RAMAL / *STRAP HINGES* / CHARNIÈRE FORME OBLONGUE PAG.56-60

BISAGRAS INVISIBLES / *CONCEALED HINGES* / CHARNIÈRES INVISIBLES PAG.61-64

BISAGRAS CON MUELLE / *SPRING HINGES* / CHARNIÈRES À RESSORTS PAG.65-68

BISAGRAS TAQUILLA Y ARMARIO METÁLICO / *HINGES FOR LOCKERS* / CHARNIÈRES POUR CASIERS PAG.69-72

BISAGRAS GAMA NAÚTICA / *NAUTICAL RANGE HINGES* / CHARNIÈRES GAMME NAUTIQUE "SPECIAL INOX.316 SECTION" PAG.73-77

BISAGRAS ESPECIALES / *SPECIAL HINGES* / CHARNIÈRES SPÉCIAUX PAG.78-81

Bisagras fijas - Fixed hinges - Charnières fixes

Ref.100 - Mod. 207

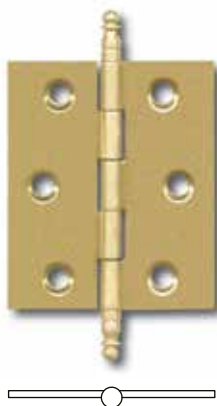

Ref./Cod.	mm Medidas Size Dimension	Agujeros x ømm Holes Trou	Ø Tornillo Screw Vis
100/001	25x25x0.8	4x3	2.5x12
100/002	30x30x0.8	4x3	2.5x12
100/003	35x30x0.8	4x3	2.5x12
100/004	40x35x0.9	4x3	2.5x12
100/005	50x35x0.9	6x3.5	2.5x12
100/006	50x40x0.9	6x3.5	2.5x12
100/007	60x35x0.9	6x4	3x16
100/008	60x40x0.9	6x4	3x16
100/009	60x50x0.9	6x4	3x16
100/010	70x40x1	6x4.5	3x16
100/011	70x50x1	6x4.5	3x16
100/012	70x55x1	6x4.5	3x16
100/013	80x50x1.1	6x5	3.5x20
100/014	80x60x1.1	6x5	3.5x20
100/844	90x60x1.2	6x5	3.5x20

Variantes / Variants / Variantes

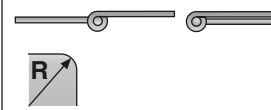

Materiales- (Acabados) / Materials- (Treatments) / Matériaux- (Finitions)

H	(PU) - (ZI) - (LA) - (NI) - (BR)
L	(PU) - (NI)
I304	(B)

Bisagras fijas - Fixed hinges - Charnières fixes

Ref.101 - Mod. 207

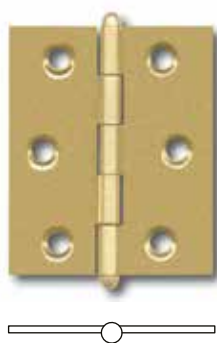

Ref./Cod.	mm Medidas Size Dimension	Agujeros x ømm Holes Trou	Ø Tornillo Screw Vis
101/001	25x25x0.8	4x3	2.5x12
101/002	30x30x0.8	4x3	2.5x12
101/003	35x30x0.8	4x3	2.5x12
101/004	40x35x0.9	4x3	2.5x12
101/005	50x35x0.9	6x3.5	2.5x12
101/006	50x40x0.9	6x3.5	2.5x12
101/007	60x35x0.9	6x4	3x16
101/008	60x40x0.9	6x4	3x16
101/009	60x50x0.9	6x4	3x16
101/010	70x40x1	6x4.5	3x16
101/011	70x50x1	6x4.5	3x16
101/012	70x55x1	6x4.5	3x16
101/013	80x50x1.1	6x5	3.5x20
101/014	80x60x1.1	6x5	3.5x20
101/844	90x60x1.2	6x5	3.5x20

Variantes / Variants / Variantes

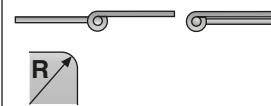

Materiales- (Acabados) / Materials- (Treatments) / Matériaux- (Finitions)

H	(PU) - (ZI) - (LA) - (NI) - (BR)
L	(PU) - (NI)
I304	(B)

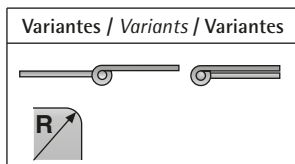

Ref./Cod.	mm Medidas Size Dimension	Agujeros x ømm Holes Trou	Ø Tornillo Screw Vis
102/015	40x35x0.9	4x3	2.5x12
102/016	50x35x0.9	6x3.5	2.5x12
102/017	50x40x0.9	6x3.5	2.5x12
102/018	60x35x0.9	6x4	3x16
102/019	60x40x0.9	6x4	3x16
102/020	60x50x0.9	6x4	3x16
102/021	70x40x1	6x4.5	3.5x20
102/022	70x50x1	6x4.5	3.5x20
102/023	70x55x1	6x4.5	3.5x20
102/024	80x50x1.1	6x5	3.5x20
102/025	80x60x1.1	6x5	3.5x20

Materiales- (Acabados) / Materials- (Treatments) / Matériaux- (Finitions)

H (PU) - (ZI) - (LA) - (NI) - (BR)

L (PU) - (NI)

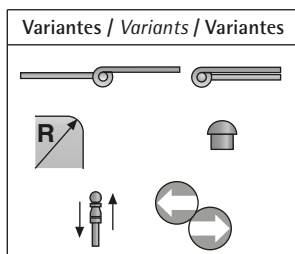
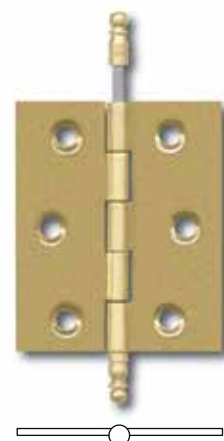

Ref./Cod.	mm Medidas Size Dimension	Agujeros x ømm Holes Trou	Ø Tornillo Screw Vis
105/036	50x40x16x0,9	6x4	2.5x12
105/037	60x40x17x0,9	6x4	2.5x12
105/038	60x45x19x0,9	6x4	2.5x12
105/039	60x50x22x0,9	6x4	2.5x12
105/040	70x40x16x1	6x4.5	2.5x12
105/041	70x40x19x1	6x4.5	2.5x12
105/042	70x45x19x1	6x4.5	2.5x12
105/043	70x50x22x1	6x4.5	2.5x12

Materiales- (Acabados) / Materials- (Treatments) / Matériaux- (Finitions)

H (PU) - (ZI) - (LA) - (NI) - (BR)

L (PU) - (NI)



Bisagras tipo mariposa - Butterfly type hinges - Charnières type papillon

Ref.103



Ref./Cod.	mm Medidas Size Dimension	Agujeros x ømm Holes Trou	Ø Tornillo Screw Vis
103/026	50x40x0.9	6x3.5	2.5x12
103/027	60x40x0.9	6x4	3x16
103/028	70x50x1	6x4.5	3.5x20

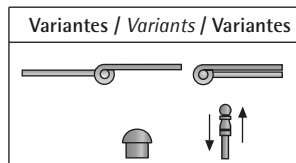

Materiales- (Acabados) / Materials- (Treatments) / Matériaux- (Finitions)

H (PU) - (ZI) - (LA) - (NI) - (BR)

L (PU) - (NI)



Bisagras tipo mariposa solapadas - Butterfly cranked hinges - Charnières papillon coudée

Ref.106

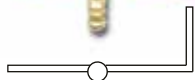

Ref./Cod.	mm Medidas Size Dimension	Agujeros x ømm Holes Trou	Ø Tornillo Screw Vis
106/044	50x40x16x0.9	6x3.5	2.5x12
106/045	60x40x17x0.9	6x4	2.5x12
106/046	60x45x19x0.9	6x4	2.5x12
106/047	70x50x22x1	6x4.5	2.5x12

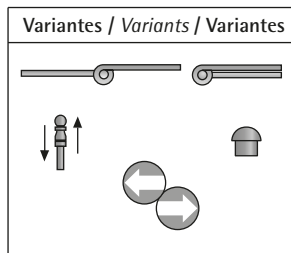

Materiales- (Acabados) / Materials- (Treatments) / Matériaux- (Finitions)

H (PU) - (ZI) - (LA) - (NI) - (BR)

L (PU) - (NI)



Bisagras doble solapadas - Double cranked hinges - Charnières double coudée

Ref.107

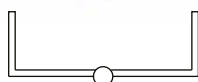

Ref./Cod.	mm Medidas Size Dimension	Agujeros x ømm Holes Trou	Ø Tornillo Screw Vis
107/048	60x40x17x0.9	6x4	2.5x12
107/049	60x45x19x0.9	6x4	2.5x12
107/050	60x50x22x0.9	6x4	2.5x12

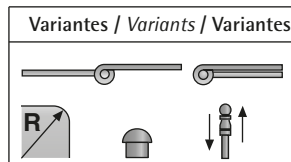

Materiales- (Acabados) / Materials- (Treatments) / Matériaux- (Finitions)

H (PU) - (ZI) - (LA) - (NI) - (BR)

L (PU) - (NI)



Ref./Cod.	mm Medidas Size Dimension	Agujeros x ømm Holes Trou	Ø Tornillo Screw Vis	
109/053	20x16x0.7	4x2	2x10	
109/054	25x18x0.8	4x3	2x10	
109/055	30x19x0.8	4x3	2x10	
109/056	35x22x0.8	4x3	2.5x12	
109/057	40x25x0.8	4x3.5	2.5x12	
109/058	50x30x0.9	4x3.5	2.5x12	
109/059	60x35x1	6x4	3x16	
109/060	70x40x1.2	6x4.5	3.5x20	
109/061	80x45x1.2	6x5	3.5x20	
109/062	90x50x1.2	6x5	3.5x20	
109/063	100x50x1.5	6x5	4x20	
109/064	110x50x1.5	6x6	4.5x25	
109/065	120x60x1.5	8x6	4.5x25	

Materiales- (Acabados) / Materials- (Treatments) / Matériaux- (Finitions)

 H	(PU) - (ZI) - (LA) - (BR)
---	---------------------------

 L	(PU)
---	------

 I304	(B)
--	-----

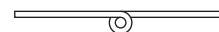
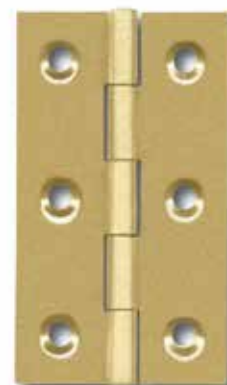

24 u.

Ref./Cod.	mm Medidas Size Dimension	Agujeros x ømm Holes Trou	Ø Tornillo Screw Vis	
110/066	25x25x0.9	4x3.5	2.5x12	
110/067	30x30x0.9	4x3.5	2.5x12	
110/068	40x40x1	4x4	3x16	
110/069	50x50x1	6x4	3x16	
110/070	60x60x1	6x4.5	4x20	
110/071	70x70x1.2	6x5	4x20	
110/072	80x80x1.2	6x5	4x20	
110/073	90x90x1.2	6x5.5	4x20	
110/074	100x100x1.5	6x5.5	4.5x25	

Materiales- (Acabados) / Materials- (Treatments) / Matériaux- (Finitions)

 H	(PU) - (ZI) - (LA) - (BR)
---	---------------------------

 L	(PU)
---	------

 I304	(B)
--	-----

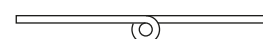

24 u.

Bisagras fijas - Fixed hinges - Charnières fixes

Ref.104

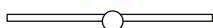
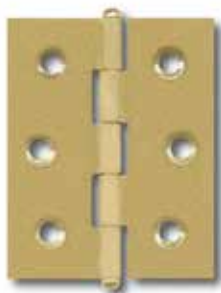

Ref./Cod.	mm Medidas Size Dimension	Agujeros x ømm Holes Trou	Ø Tornillo Screw Vis
104/029	25x25x1	4x3	2.5x12
104/030	30x30x1	4x3	2.5x12
104/031	40x35x1	4x3	2.5x12
104/032	40x40x1	4x3	2.5x12
104/033	50x40x1	6x3.5	2.5x12
104/034	50x50x1	6x3.5	2.5x12
104/035	60x50x1	6x4	3x16

Variantes / Variants / Variations



Materiales- (Acabados) / Materials- (Treatments) / Matériaux- (Finitions)

H (PU) - (ZI) - (LA) - (NI) - (BR)

L (PU) - (NI)



Bisagras fijas - Fixed hinges - Charnières fixes

Ref.122 - Mod. 838

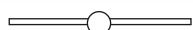
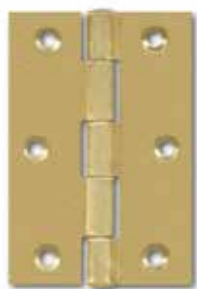

Ref./Cod.	mm Medidas Size Dimension	Pulgadas Inches Pouces	Agujeros x ømm Holes Trou	Ø Tornillo Screw Vis
122/125	50x40x1.5	2	4x3.5	3x12
122/126	63x45x1.5	2.5	6x4.5	3.5x20
122/127	75x50x1.5	3	6x4.5	3.5x20
122/128	90x60x1.5	3.5	6x5	3.5x20
122/129	100x70x1.5	4	8x5.5	4x20

Variantes / Variants / Variations



Materiales- (Acabados) / Materials- (Treatments) / Matériaux- (Finitions)

H (PU) - (LA) - (ZI) - (NL.L) - (PA)

L (PU)

1304 (B)



Bisagras desmontables - Loose pin hinges - Charnières démontables

Ref.123 - Mod. 840



Ref./Cod.	mm Medidas Size Dimension	Pulgadas Inches Pouces	Agujeros x ømm Holes Trou	Ø Tornillo Screw Vis
123/130	50x40x1.5	2	4x3.5	3x12
123/131	63x45x1.5	2.5	6x4.5	3.5x20
123/132	75x50x1.5	3	6x4.5	3.5x20
123/133	90x60x1.5	3.5	6x5	3.5x20
123/134	100x70x1.5	4	8x5.5	4x20

Variantes / Variants / Variations



Materiales- (Acabados) / Materials- (Treatments) / Matériaux- (Finitions)

H (PU) - (LA) - (ZI) - (NL.L) - (PA)

L (PU)



Bisagras desmontables (con remates) - *Loose pin hinges (with ball tips)* - Charnières démontables (à souches)

Variantes / Variants / Variantes



Ref./Cod.	mm Medidas Size Dimension	Pulgadas Inches Pouces	Agujeros x ømm Holes Trou	Ø Tornillo Screw Vis
124/135	50x40x1.5	2	4x3.5	3x12
124/136	63x45x1.5	2.5	6x4.5	3.5x20
124/137	75x50x1.5	3	6x4.5	3.5x20
124/138	90x60x1.5	3.5	6x5	3.5x20
124/139	100x70x1.5	4	8x5.5	4x20

Materiales- (Acabados) / Materials- (Treatments) / Matériaux- (Finitions)

H (PU) - (LA) - (ZI) - (NL.L) - (PA)

L (PU)

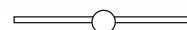

Bisagras fijas con remates especiales - *Special coping* - Souches spéciales

Variantes / Variants / Variantes



Ref./Cod.	mm Medidas Size Dimension	Pulgadas Inches Pouces	Agujeros x ømm Holes Trou	Ø Tornillo Screw Vis
125/140	50x40x1.5	2	4x3.5	3x12
125/141	63x45x1.5	2.5	6x4.5	3.5x20
125/142	75x50x1.5	3	6x4.5	3.5x20
125/143	90x60x1.5	3.5	6x5	3.5x20
125/144	100x70x1.5	4	8x5.5	4x20

Materiales- (Acabados) / Materials- (Treatments) / Matériaux- (Finitions)

H (PU) - (LA) - (ZI) - (NL.L) - (PA)

L (PU)

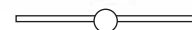
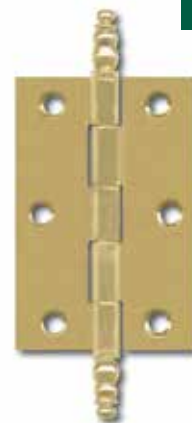

Bisagras para mueble - *Cabinet flag hinges* - Fiches à larder

Variantes / Variants / Variantes



Ref./Cod.	mm Medidas Size Dimension	Agujeros x ømm Holes Trou	Ø Tornillo Screw Vis
129/161	50x45x1.5	4x3.5	3x16

Materiales- (Acabados) / Materials- (Treatments) / Matériaux- (Finitions)

L (PU) - (CU)



Bisagras vaso - High copings hinges - Charnières avec souches élevées

Ref.121 - Mod. 601



Ref./Cod.	mm Medidas Size Dimension	Agujeros x ømm Holes Trou	Ø Tornillo Screw Vis
121/120	30x40x1.2	4x4	3x16
121/121	40x45x1.5	6x4.5	3.5x20
121/122	40x50x1.5	6x4.5	3.5x20
121/123	50x40x1.5	6x4.5	3.5x20
121/124	60x40x1.5	6x4.5	4x20

Variantes / Variants / Variantes

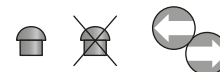

Materiales- (Acabados) / Materials- (Treatments) / Matériaux- (Finitions)

H (PU) - (LA) - (NI)

L (PU) - (NI)



Bisagras quita y pon - Unfasten and fasten hinges - Charnières démontables

Ref.119 - Mod. 208



Ref./Cod.	mm Medidas Size Dimension	Agujeros x ømm Holes Trou	Ø Tornillo Screw Vis
119/107	40x35x0.8	4x3	2.5x12
119/108	50x40x0.8	6x3.5	2.5x12
119/109	60x40x0.9	6x4	3x16
119/110	60x50x0.9	6x4	3x16
119/111	70x50x1	6x4.5	3x16
119/112	80x60x1.1	6x5	3.5x20

Variantes / Variants / Variantes

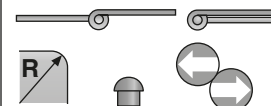

Materiales- (Acabados) / Materials- (Treatments) / Matériaux- (Finitions)

H (PU) - (ZI) - (LA) - (NI) - (BR)

L (PU) - (NI)

I304 (B)



Bisagras en perfil latón - Brass profile hinges - Charnières profil laiton

Ref.331

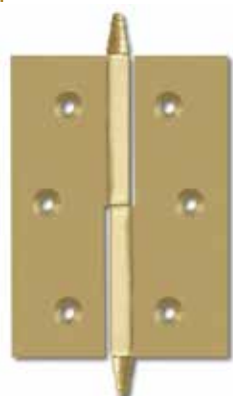

Ref./Cod.	mm Medidas Size Dimension	Agujeros x ømm Holes Trou	Ø Tornillo Screw Vis
331/1004	50x40x2	6x4	3.5x20
331/1005	60x40x2	6x4	3.5x20
331/1006	60x50x2	6x4	3.5x20
331/1007	70x50x2	6x4	3.5x20
331/1008	80x60x2.6	6x5	4x20
331/1009	90x60x2.6	6x5	4x20
331/1010	100x70x2.7	6x5	4x20
331/1011	120x80x3	6x5	4x20

Variantes / Variants / Variantes



Materiales- (Acabados) / Materials- (Treatments) / Matériaux- (Finitions)

L (SA) - (CU) - (CR)



Variantes / *Variants* / *Variantes*

Ref./Cod.	mm Medidas Size Dimension	Agujeros x ømm Holes Trou	Ø Tornillo Screw Vis
130/162	50x40x2	6x3.75	3x16
130/163	60x40x2	6x3.75	3x16
130/164	60x50x2	6x3.75	3x16
130/165	70x50x2	6x4.5	3.5x20
130/838	80x60x2	6x3.75	3x16

Materiales- (Acabados) / *Materials- (Treatments)* / *Matériaux- (Finitions)*

L (SA)

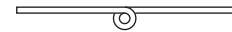
Variantes / *Variants* / *Variantes*

Ref./Cod.	mm Medidas Size Dimension	Agujeros x ømm Holes Trou	Ø Tornillo Screw Vis
131/166	50x40x2	6x3.75	3x16
131/167	60x40x2	6x3.75	3x16
131/168	60x50x2	6x3.75	3x16
131/169	70x50x2	6x4.5	3.5x20
131/839	80x60x2	6x3.75	3x16

Materiales- (Acabados) / *Materials- (Treatments)* / *Matériaux- (Finitions)*

L (SA)





Ref./Cod.	mm Medidas Size Dimension	Agujeros x ømm Holes Trou	Ø Tornillo Screw Vis
132/170	30x80x1.5	6x5	3.5x20

Materiales- (Acabados) / *Materials- (Treatments)* / *Matériaux- (Finitions)*

L (PUE) - (CR)



Ref./Cod.	mm Medidas /AxBxC Size Dimension	E	d	D	Agujeros x ømm Holes Trou	ø Tornillo Screw Vis	
126/146	50x20x1.2	3.2	6		6x4	3x16	
126/147	50x25x1.2	3.2	6		6x4	3x16	
126/148	60x25x1.5	3	6		6x4	3x16	
126/149	60x30x1.5	3	6		6x4	3x16	
126/150	50x20x0.9	2.7	4.5		4x3	2.5x12	
126/151	60x25x1.2	3.5	6		6x4	2.5x12	
126/152	60x30x1.5	3.6	4.2	6.6	6x4	2.5x12	

Materiales- (Acabados) / Materials- (Treatments) / Matériaux- (Finitions)	
 H	(LA) - (NI) - (ZI)
 L	(PU) - (NI)

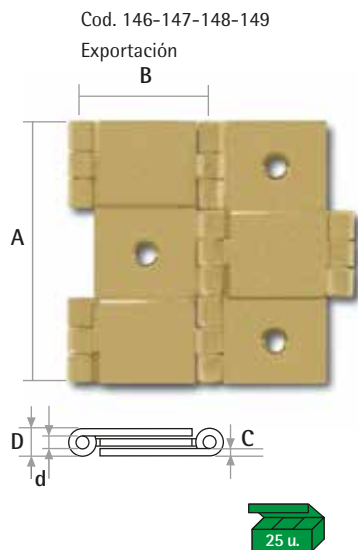

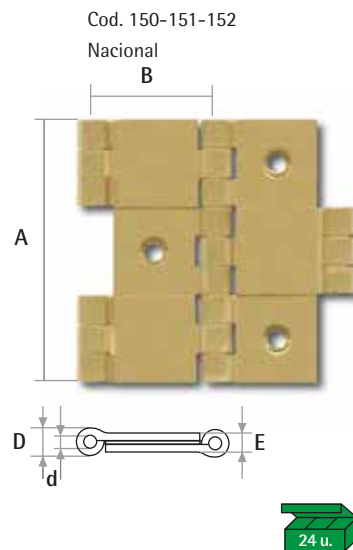
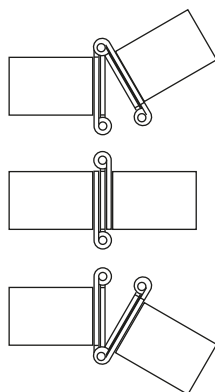

Funcionamiento / Operation / Fonctionnement

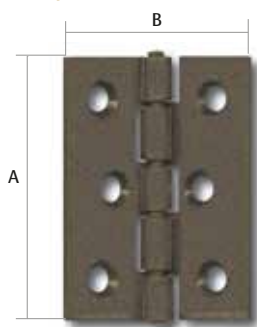

Bisagras de apertura limitada - Open Limited Hinges - Charnières D'ouverture Limitée



Ref./Cod.	mm Medidas Size/Dimension AxBxC	G	Agujeros x ømm Holes Trou	ø Tornillo Screw Vis	
200/309	50x40x1.5	85°	6x4.75	3.5x20	
200/339	50x40x1.5	110°	6x4.75	3.5x20	

Materiales- (Acabados) / Materials- (Treatments) / Matériaux- (Finitions)	
 L	(PU) - (CU)

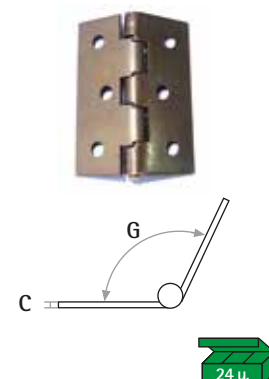

Ref.170

Bisagras tipo inglesa - *Flush hinges* - Charnière universelle

Ref./Cod.	mm Medidas Size Dimension	Agujeros x ømm Holes Trou	Ø Tornillo Screw Vis
170/283	50	4x4	3x16
170/750	50	4x4	3x16

Materiales- (Acabados) / Materials- (Treatments) / Matériaux- (Finitions)

H (PU) - (LA) - (BR) - (NI)

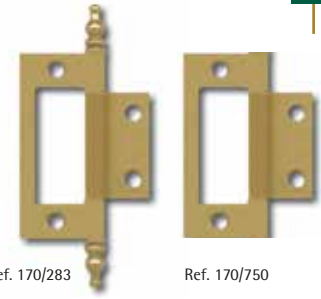

Ref. 170/283

Ref. 170/750



24 u.

Ref.171

Bisagras artísticas - *Ornamental Hinges* - Charnière Rustique

Ref./Cod.	mm Medidas Size / Dimension A x B x C x D x E	Agujeros x ømm Holes Trou	Ø Tornillo Screw Vis
171/284	66x36x1.5x16x11	6x3.5	3x16

Materiales- (Acabados) / Materials- (Treatments) / Matériaux- (Finitions)

H (NI) - (LA) - (LA.L) - (PA)

L (PU) - (CU)

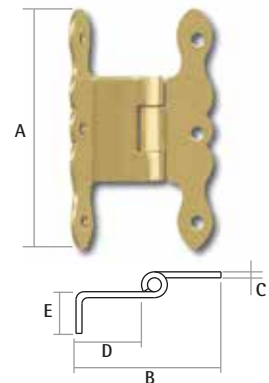

100 u.

Ref.108

Bisagras con ala solapada - *Hinges with 1 cranked leaf* - Charnière avec 1 aile cambrée

Ref./Cod.	mm Medidas Size Dimension	Agujeros x ømm Holes Trou	Ø Tornillo Screw Vis
108/051	40x42x18x1.5	4x4	3x16
108/052	40x45x18x1.5	4x4	3x16

Materiales- (Acabados) / Materials- (Treatments) / Matériaux- (Finitions)

H (PU) - (ZI) - (LA) - (NI) - (BR)

L (PU) - (NI)



24 u.

Ref.536

Bisagras fijas con remates altos - *Fixed hinges with high copings* - Charnières fixes à vases

Variantes / Variants / Variantes



Ref./Cod.	mm Medidas Size Dimension	Agujeros x ømm Holes Trou	Ø Tornillo Screw Vis
536/1258	50x40x1.5	6x4.5	3.5x20
536/1259	60x40x1.5	6x4.5	3.5x20
536/1260	70x50x1.5	6x4.5	3.5x20

Materiales- (Acabados) / Materials- (Treatments) / Matériaux- (Finitions)

I304 (SA)





24 u.

Bisagras estilo provenzal - Provençal hinges - Charnières style provençal

Ref.168



Ref./Cod.	mm Medidas Size Dimension	Montaje Assembly Montage	Complementos Complements Compléments
168/281	35x40x6	Taco directo  4x12	Tuerca fijación  Tornillo 4x12

Materiales- (Acabados) / Materials- (Treatments) / Matériaux- (Finitions)



Z (CU)



Bisagras estilo provenzal - Provençal hinges - Charnières style provençal

Ref.169



Ref./Cod.	mm Medidas Size Dimension	Montaje Assembly Montage	Complementos Complements Compléments
169/282	32x50x7	Taco directo  4x12	Tuerca fijación  Tornillo 4x12

Materiales- (Acabados) / Materials- (Treatments) / Matériaux- (Finitions)

Z (CU)



Bisagras planas para armarios - Flat hinges for cupboards - Charnières plates pour armoires

Ref.208



Ref./Cod.	mm Medidas Size Dimension	Agujeros x ømm Holes Trou	Ø Tornillo Screw Vis
208/322	50x40x0.8	5x3.5	3x16

Materiales- (Acabados) / Materials- (Treatments) / Matériaux- (Finitions)

I304 (B)



Bisagras para armarios de cocina tipo balín - Kitchen cupboard hinges - Charnières pour armoires de cuisine

Ref.209



Ref./Cod.	mm Medidas Size Dimension	Agujeros x ømm Holes Trou	Ø Tornillo Screw Vis
209/323	60x10x1.5	4x3.5	3x16

Materiales- (Acabados) / Materials- (Treatments) / Matériaux- (Finitions)

I304 (B)



Ref.759

Bisagras mariposa artísticas - *Ornamental hinges* - Charnière rustique

Ref./Cod.	mm Medidas Size / Dimension A x B x C	Agujeros x ømm Holes Trou	ø Tornillo Screw Vis
759/4755	30x41x1.2	4x3.2	3x16

Materiales- (Acabados) / Materials- (Treatments) / Matériaux- (Finitions)	
 (PING)	



Ref.759

Bisagras apaisadas artísticas - *Ornamental hinges* - Charnière rustique

Ref./Cod.	mm Medidas Size / Dimension A x B x C	Agujeros x ømm Holes Trou	ø Tornillo Screw Vis
759/4756	30x60x1.2	4x3.2	3x16

Materiales- (Acabados) / Materials- (Treatments) / Matériaux- (Finitions)	
 (PING)	



Ref.759

Cierre bisagra apaisada - *Ornamental fittings* - Petite fermeture rustique

Ref./Cod.	mm Medidas Size / Dimension A x B x C	Agujeros x ømm Holes Trou	ø Tornillo Screw Vis
759/4817	30x60x1.2	6x3.2	3x16

Materiales- (Acabados) / Materials- (Treatments) / Matériaux- (Finitions)	
 (PING)	



Bisagra castellana mariposa - Ornamental hinges - Charnière rustique

Ref.600



Ref./Cod.	mm Medidas Size / Dimension A x B x C	Agujeros x ømm Holes Trou	Ø Tornillo Screw Vis
600/4167	80x65x2	6x3.8	3x16

Materiales- (Acabados) / Materials- (Treatments) / Matériaux- (Finitions)

H (PING)



Bisagra castellana apaisada- Ornamental Hinges - Charnière rustique

Ref.600



Ref./Cod.	mm Medidas Size / Dimension A x B x C	Agujeros x ømm Holes Trou	Ø Tornillo Screw Vis
600/4166	80x150x1,5	6x3.8	3x16

Materiales- (Acabados) / Materials- (Treatments) / Matériaux- (Finitions)

H (PING)



Cierres para arcón - Ornamental fittings - Fermeture rustique

Ref.759



Ref./Cod.	mm Medidas Size / Dimension A x B x C	Agujeros x ømm Holes Trou	Ø Tornillo Screw Vis
759/4818	80x150x1,5	5x3.8	3x16

Materiales- (Acabados) / Materials- (Treatments) / Matériaux- (Finitions)

H (PING)



BISAGRAS PARA LA CONSTRUCCIÓN

HINGES FOR CONSTRUCTION

CHARNIÈRES POUR LA CONSTRUCTION





Ref./Cod.	mm Medidas Size Dimension	Pulgadas Inches Pouces	Agujeros x ømm Holes Trou	Ø Tornillo Screw Vis
135/1922	101x76x3	4x3	8x6.5	5x25
135/1923	101x89x3	4x3 1/2	8x6.5	5x25
135/183	101x101x3	4x4	8x6.5	5x25
135/1924	114x101x4	4 1/2x4	8x8	5.5x30

Variantes / Variants / Variantes



Radio Estándar = 10mm

Materiales- (Acabados) / Materials- (Treatments) / Matériaux- (Finitions)

I304 (SA)

Certificado **CE**



Características / Characteristics / Caractéristiques

Bisagras fijas, con rodamientos, diseñadas especialmente para uso severo en edificios y viviendas. Han conseguido el grado 13 en la certificación CE de "Tecnalia", lo que garantiza entre otras cosas, su calidad y durabilidad.

Fixed pin hinges, with ball bearings, for use in heavy use situations. Within CE certification by "Tecnalia". They've achieved a hinge grading of 13. Ensuring its quality and durability.

Charnières fixes, à roulements, spécialement conçues pour une forte usage en immeubles et logements. Dans la certification CE, par "Tecnalia", ces charnières ont obtenues le degré 13, assurant leur haute qualité et durabilité.

Marcaje CE

En Metalurgia Pons.LIM,S.L ya disponemos de algunos modelos con marcado CE (Certificado de conformidad UNE-EN 1935:2000). Actualmente la referencia 135 de nuestro catálogo.

CE marking

By Metalurgia Pons. LIM, S.L., CE, UNE-EN 1935:2002 certified products are already available. Currently our reference 135

Marquage CE

À Metalurgia Pons.LIM, S.L., nous avons déjà disponibles quelque modèles avec le marquage CE, UNE-EN 1935:2002. Actuellement, nous l'avons dans la référence 135 de notre catalogue.



Variantes / Variants / Variantes

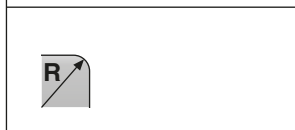

Ref./Cod.	mm Medidas Size Dimension	Pulgadas Inches Pouces	Agujeros x ømm Holes Trou	Ø Tornillo Screw Vis
135/181	76x76x2	3x3	6x5.7	4.5x25
135/182	89x89x2.5	3 1/2x3 1/2	6x6.5	4.5x25
135/1922	101x76x3	4x3	8x6.5	5x25
135/1923	101x89x3	4x3 1/2	8x6.5	5x25
135/183	101x101x3	4x4	8x6.5	5x25
135/1924	114x101x4	4 1/2x4	8x8	5.5x30
135/2771	114x114x4	4 1/2x4 1/2	8x7	5.5x30
135/1548	150x90x3.5	6x3 1/2	10x7	5.5x30

Materiales- (Acabados) / Materials- (Treatments) / Matériaux- (Finitions)

L (SA)

1304 (SA)



Ref. 136 Desmontables con rodamientos - Disassemblables with ball bearings - Démontables à roulements

Variantes / Variants / Variantes



Ref./Cod.	mm Medidas Size Dimension	Pulgadas Inches Pouces	Agujeros x ømm Holes Trou	Ø Tornillo Screw Vis
136/184	76x76x2	3x3	6x5.7	4.5x25
136/185	89x89x2.5	3 1/2x3 1/2	6x6.5	4.5x25
136/186	101x101x3	4x4	8x6.5	5x25

Materiales- (Acabados) / Materials- (Treatments) / Matériaux- (Finitions)

L (SA)

1304 (SA)

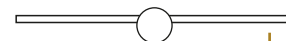

Bisagras fijas - Fixed hinges - Fixes à roulements

Variantes / Variants / Variantes



Ref./Cod.	mm Medidas Size Dimension	Pulgadas Inches Pouces	Agujeros x ømm Holes Trou	Ø Tornillo Screw Vis
133/171	50x50x1.5	2x2	6x4	3x16
133/172	63x63x1.5	2 1/2x2 1/2	6x5.5	4x20
133/173	76x76x2	3x3	6x6.2	4.5x25
133/500	89x63x2.5	3 1/2x2 1/2	6x6.5	5x25
133/501	89x76x2.5	3 1/2x3	6x6.5	5x25
133/174	89x89x2.5	3 1/2x3 1/2	6x6.5	5x25
133/502	101x76x2.5	4x3	8x6.5	5x25
133/525	101x89x2.5	4x3 1/2	8x6.5	5x25
133/175	101x101x2.5	4x4	8x6.5	5x25

Materiales- (Acabados) / Materials- (Treatments) / Matériaux- (Finitions)

H (PU) - (ZI) - (LA)

L (PU) - (SA.L)

1304 (SA)

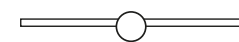

Bisagras desmontables - *Disassemblables* - *Démontables*

Ref.134 - Mod.565

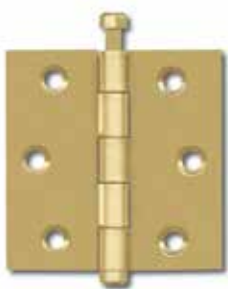

Ref./Cod.	mm Medidas Size Dimension	Pulgadas Inches Pouces	Agujeros x ømm Holes Trou	Ø Tornillo Screw Vis
134/176	50x50x1.5	2x2	6x4	3x16
134/177	63x63x1.5	2 1/2x2 1/2	6x5.5	4x20
134/178	76x76x2	3x3	6x6.2	4.5x25
134/574	89x63x2.5	3 1/2x2 1/2	6x6.5	5x25
134/575	89x76x2.5	3 1/2x3	6x6.5	5x25
134/179	89x89x2.5	3 1/2x3 1/2	6x6.5	5x25
134/576	101x76x2.5	4x3	8x6.5	5x25
134/577	101x89x2.5	4x3 1/2	8x6.5	5x25
134/180	101x101x2.5	4x4	8x6.5	5x25

Variantes / *Variants* / *Variantes*



Materiales- (Acabados) / *Materials- (Treatments)* / *Matériaux- (Finitions)*

H	(PU) - (ZI) - (LA)
L	(PU) - (SA.L)
I304	(SA)



Fijas - *Fixed* - *Fixes*

Ref.127 - Mod. 554

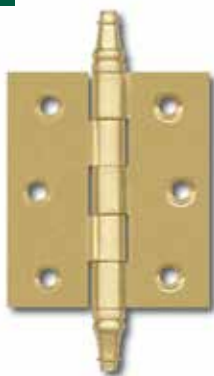

Ref./Cod.	mm Medidas Size Dimension	Agujeros x ømm Holes Trou	Ø Tornillo Screw Vis
127/153	50x40x1.5	6x4.5	3.5x20
127/154	60x50x2	6x4.5	3.5x20
127/155	70x60x2	6x4.5	3.5x20
127/156	80x70x2	6x4.5	3.5x20

Variantes / *Variants* / *Variantes*



Materiales- (Acabados) / *Materials- (Treatments)* / *Matériaux- (Finitions)*

H	(LA)
L	(PU) - (SA.L)



Fijas con arandelas - *Fixed with washers* - *Fixes avec rondelles*

Ref.128 - Mod. 555

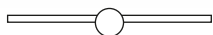
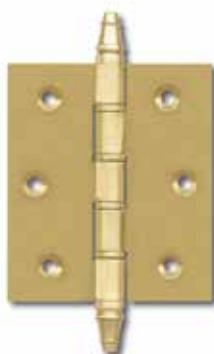

Ref./Cod.	mm Medidas Size Dimension	Agujeros x ømm Holes Trou	Ø Tornillo Screw Vis
128/157	50x40x1.5	6x4.5	3.5x20
128/158	60x50x2	6x4.5	3.5x20
128/159	70x60x2	6x4.5	3.5x20
128/2340	80x60x2.5	6x4.5	3.5x20
128/160	80x70x2	6x4.5	3.5x20

Variantes / *Variants* / *Variantes*



Materiales- (Acabados) / *Materials- (Treatments)* / *Matériaux- (Finitions)*

H	(LA)
L	(PU) - (SA.L)
I304	(SA)



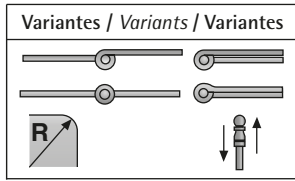

Ref./Cod.	mm Medidas Size Dimension	Agujeros x ømm Holes Trou	Ø Tornillo Screw Vis
153/757	75x71x2.5	6x5.5	4.5x25
153/503	76x76x2.5	6x5.5	4.5x25
153/758	90x85x2.5	6x5.5	4.5x25
153/251	100x96x3	8x5.5	4.5x25

Materiales- (Acabados) / Materials- (Treatments) / Matériaux- (Finitions)

H (PU) - (ZI)

I304 (SA)

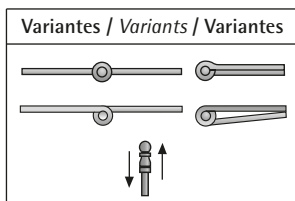

Ref./Cod.	mm Medidas Size Dimension	Agujeros x ømm Holes Trou	Ø Tornillo Screw Vis
590/4105	90x37x2	6x4.5	3.5x16
153/845	75x55x2.5	6x5.5	4.5x25

Materiales- (Acabados) / Materials- (Treatments) / Matériaux- (Finitions)

I304 (SA)



590/4105

153/845

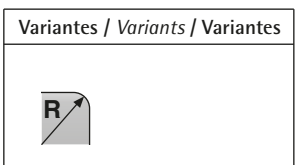
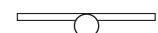

Ref./Cod.	mm Medidas Size Dimension	Agujeros x ømm Holes Trou	Ø Tornillo Screw Vis
128/2343	75x80x2	6x8	4.5x25

Materiales- (Acabados) / Materials- (Treatments) / Matériaux- (Finitions)

I304 (SA)

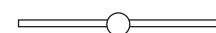

Bisagra reforzada - Heavy duty hinges - Charnières renforcées

Ref.181

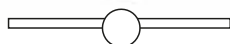

Ref./Cod.	mm Medidas Size Dimension	Agujeros x ømm Holes Trou	Ø Tornillo Screw Vis
181/559	150x80x3	8x6	5x25
181/558	150x90x3	8x6	5x25
181/557	150x100x3	8x6	5x25
181/556	150x120x3	8x6	5x25
181/303	150x150x3	8x6	5x25
181/304	150x180x3	8x6	5x25

Variantes / Variants / Variantes

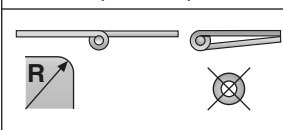

Materiales- (Acabados) / Materials- (Treatments) / Matériaux- (Finitions)

I304 (SA)



Bisagra reforzada - Heavy duty hinges - Charnières renforcées

Ref.524

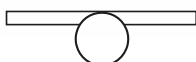

Ref./Cod.	mm Medidas Size Dimension	Agujeros x ømm Holes Trou	Ø Tornillo Screw Vis
524/2527	70x70x4	4x8.5	6x30

Variantes / Variants / Variantes

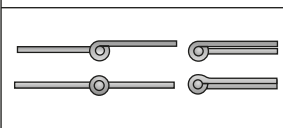

Materiales- (Acabados) / Materials- (Treatments) / Matériaux- (Finitions)

I304 (B)



Bisagra persiana - Parliament hinge - Parlement charnière

Ref.263

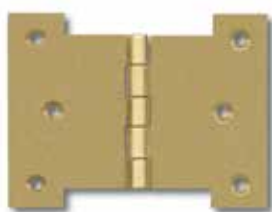

Ref./Cod.	mm Medidas Size Dimension	Agujeros x ømm Holes Trou	Ø Tornillo Screw Vis
263/338	90x120x2.5	6x5	4x20

Materiales- (Acabados) / Materials- (Treatments) / Matériaux- (Finitions)

H (LA.L) - (BR)

L (SA)



Ref.157

De seguridad desmontable - *Safety dismantle type* - À sûreté démontable

Variantes / Variants / Variantes

Ref./Cod.	mm Medidas Size Dimension	Agujeros x ømm Holes Trou	Ø Tornillo Screw Vis
157/255	75x75x2	6x6	4.5x25
157/256	89x89x2.5	6x6.5	5x25

Materiales- (Acabados) / Materials- (Treatments) / Matériaux- (Finitions)

1304 (B)



Ref.1021

De seguridad - *Security* - De Sécurité

Variantes / Variants / Variantes

Ref./Cod.	mm Medidas Size Dimension	Agujeros x ømm Holes Trou	Ø Tornillo Screw Vis
1021/2032	150x80	5,50x4	4x30

Materiales- (Acabados) / Materials- (Treatments) / Matériaux- (Finitions)

H (CR) - (LA)

1304 (B)



Ref.159

De seguridad desmontable - *Safety dismantle type* - À sûreté démontable

Variantes / Variants / Variantes

Ref./Cod.	mm Medidas Size Dimension	Agujeros x ømm Holes Trou	Ø Tornillo Screw Vis
159/980	150x80x3	8x6	5x25
159/259	150x90x3	8x6	5x25
159/560	150x100x3	8x6	5x25
159/1773	150x120x3	8x6	5x25
159/4783	150x150x3	8x6	5x25
159/4784	150x180x3	8x6	5x25

Materiales- (Acabados) / Materials- (Treatments) / Matériaux- (Finitions)

1304 (SA)



Cuadrada 3 nudos - Square - Carrée

Ref.111



Ref./Cod.	mm Medidas Size Dimension	Agujeros x ømm Holes Trou	Ø Tornillo Screw Vis
111/075	40x40x2	4x4	3.5x20
111/076	50x50x2	4x5.2	4x20
111/2694	80x80x2.5	6x5.5	4.5x25

Materiales- (Acabados) / Materials- (Treatments) / Matériaux- (Finitions)

H (PU) - (ZI) - (BRI)

I304 (B)

Variantes / Variants / Variantes

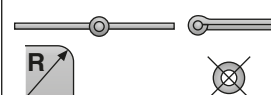

Cuadrada 5 nudos - Square - Carrée

Ref.111

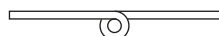

Ref./Cod.	mm Medidas Size Dimension	Agujeros x ømm Holes Trou	Ø Tornillo Screw Vis
111/077	60x60x2	6x5.2	4x20
111/078	75x75x2	6x6	4.5x25
111/079	75x75x2.5	6x5.5	4.5x25

Materiales- (Acabados) / Materials- (Treatments) / Matériaux- (Finitions)

H (PU) - (ZI) - (BRI)

I304 (B)

Variantes / Variants / Variantes

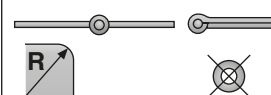

Cuadrada - Square - Carrée

Ref.172

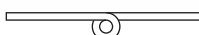

Ref./Cod.	mm Medidas Size Dimension	Agujeros x ømm Holes Trou	Ø Tornillo Screw Vis
172/1024	40x40x1.5	4x4.5	3.5x20
172/288	50x50x1.2	6x4.5	3.5x20
172/1025	50x50x1.5	6x4.5	3.5x20
172/1026	60x60x1.5	6x4.5	4x20

Materiales- (Acabados) / Materials- (Treatments) / Matériaux- (Finitions)

I304 (B)

Variantes / Variants / Variantes

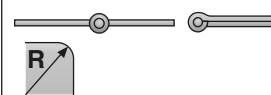

Variantes / *Variants* / Variantes

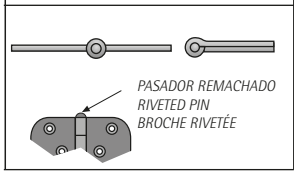

Ref./Cod.	mm Medidas Size Dimension	Agujeros x ømm Holes Trou	Ø Tornillo Screw Vis
172/291	63x31x2	6x5.5	4x20
172/292	63x48x2	6x5.5	4x20

Características /
Characteristics /
Caractéristiques

Con pasador latón desmontable /
With brass loose pin /
Avec broche démontable en laiton

Materiales - (Acabados) /
Materials - (Treatments) /
Matériaux - (Finitions)

I304 (B)



Ref. 172/291



Ref. 172/292



Variantes / *Variants* / Variantes

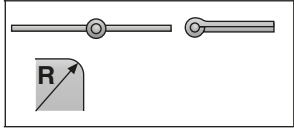

Ref./Cod.	mm Medidas Size Dimension	Agujeros x ømm Holes Trou	Ø Tornillo Screw Vis
172/285	50x30x1.2	6x4.5	3x16
172/287	50x40x1.2	6x4.5	3x16

Materiales- (Acabados) / *Materials- (Treatments)* / Matériaux- (Finitions)

I304 (B)



Variantes / *Variants* / Variantes

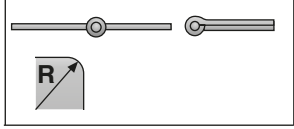

Ref./Cod.	mm Medidas Size Dimension	Agujeros x ømm Holes Trou	Ø Tornillo Screw Vis
172/286	50x38x1.2	4x5	3.5x20
172/341	50x38x1.5	4x5	3.5x20

Materiales- (Acabados) / *Materials- (Treatments)* / Matériaux- (Finitions)

I304 (B)



Bisagras en acero inox - *Stainless steel hinges* - Charnières en acier inox

Ref.172



Ref./Cod.	mm Medidas Size Dimension	Agujeros x ømm Holes Trou	Ø Tornillo Screw Vis
172/289	60x45x1.5	6x4.5	3.5x20

Variantes / *Variants* / *Variantes*

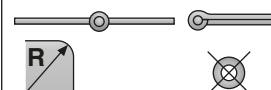

Materiales- (Acabados) / *Materials- (Treatments)* / *Matériaux- (Finitions)*

1304 (B)



Bisagras en acero inox - *Stainless steel hinges* - Charnières en acier inox

Ref.172



Ref./Cod.	mm Medidas Size Dimension	Agujeros x ømm Holes Trou	Ø Tornillo Screw Vis
172/290	60x45x2	6x4.5	3.5x20

Variantes / *Variants* / *Variantes*

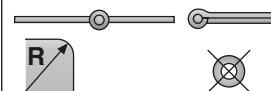

Materiales- (Acabados) / *Materials- (Treatments)* / *Matériaux- (Finitions)*

1304 (B)



Bisagras en acero inox - *Stainless steel hinges* - Charnières en acier inox

Ref.172



Ref./Cod.	mm Medidas Size Dimension	Agujeros x ømm Holes Trou	Ø Tornillo Screw Vis
172/2291	60x48x2	4x(5.5x8.5)	3.5x20

Variantes / *Variants* / *Variantes*

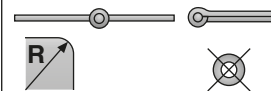

Materiales- (Acabados) / *Materials- (Treatments)* / *Matériaux- (Finitions)*

1304 (B)



Ref.172

Bisagras - Hinges - Charnières

Variantes / Variants / Variantes



Ref./Cod.	mm Medidas Size Dimension	Agujeros x ømm Holes Trou	Ø Tornillo Screw Vis
172/2400	60x40x1.5	6x4.5	3.5x20

Materiales- (Acabados) / Materials- (Treatments) / Matériaux- (Finitions)

I304 (B)



Ref.172

Bisagras - Hinges - Charnières

Variantes / Variants / Variantes



Ref./Cod.	mm Medidas Size Dimension	Agujeros x ømm Holes Trou	Ø Tornillo Screw Vis
172/1209	60x50x1.5	3x4.2 + 2x5	3.5x20

Materiales- (Acabados) / Materials- (Treatments) / Matériaux- (Finitions)

I304 (B)



Ref.219

Placa roscada para perfiles - Plate with metric holes - Plaque avec filetage métrique

Ref./Cod.	mm Medidas Size / Dimension A x B x C	Agujeros Holes Trou	F
219/1212	18 x 8 x 3	1xM4	-
219/1211	20 x 10 x 3	1xM4	-
219/4813	50 x 17 x 3	2xM5	29,5
219/1210	55 x 7,5 x 3	2xM4	37
219/723	58 x 8,5 x 3	2xM5	40
219/336	58 x 8,5 x 3	2xM5	42,5
219/4814	58 x 14 x 3	2xM4	40
219/1070	58 x 14 x 3	2xM5	40
219/4780	60 x 7 x 3	3xM4	40
219/2814	60 x 8,5 x 3	2xM4	45
219/4815	60 x 9 x 3	3xM4	42
219/4521	60 x 15 x 3	2xM5	39

Materiales- (Acabados) / Materials- (Treatments) / Matériaux- (Finitions)

I304 (B)

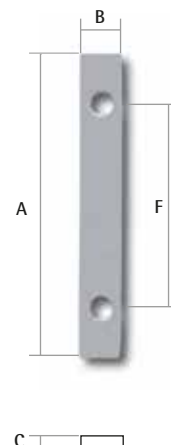

Ref./Cod.	Descripción Name Dénomination	mm Medidas/Size Dimension		Agujeros Holes / Trou Nº x Ømm	ØTornillo Screw Vis
		A x B x C	E x F x H x G		
229/1876	Golfo con correa plana / <i>Straight strap hinges</i> / Penture droite	135x20x5	150x20xHx4	3x5	4,5x25-40
229/368	Golfo con correa plana / <i>Straight strap hinges</i> / Penture droite	135x20x5	200x20xHx4	3x5	4,5x25-40
229/1877	Golfo con correa plana / <i>Straight strap hinges</i> / Penture droite	135x25x5	250x25xHx4	4x5	4,5x25-40
229/1878	Golfo con correa plana / <i>Straight strap hinges</i> / Penture droite	135x25x5	300x25xHx4	5x5	4,5x25-40
230/1879	Golfo con correa codo / <i>Cranket strap hinges</i> / Penture coudée	175x25x5	200x20x35x4	4x5	4,5x25-40
230/370	Golfo con correa codo / <i>Cranket strap hinges</i> / Penture coudée	175x25x5	250x25x35x4	4x5	4,5x25-40
231/1880	Golfo antirrobo / <i>Invisible strap hinges</i> / Penture droite à il intérieur	135x20x5	200x20x40x4	4x5	4,5x25-40
231/371	Golfo antirrobo / <i>Invisible strap hinges</i> / Penture droite à il intérieur	135x20x5	250x25x40x4	5x5	4,5x25-40
232/372	Golfo antirrobo codo / <i>Invisible cranket strap hinges</i> / Penture coudée à il intérieur	190x25x5	250x25x74x4	5x5	4,5x25-40
152/339	Golfo con pernio / <i>Lift off hinges for brick work</i> / Paumelle à sceller	130x20x3	Ex120x23x3	3x5	4,5x25
152/250	Golfo con pernio / <i>Lift off hinges for brick work</i> / Paumelle à sceller	130x20x3	Ex120x38x3	3x5	4,5x25

Materiales- (Acabados) / Materials- (Treatments) / Matériaux- (Finitions)

1304 (B)

1316 (B)

L (B)

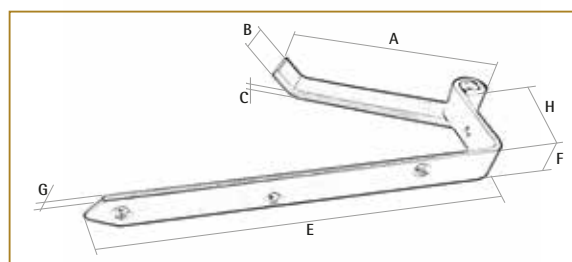
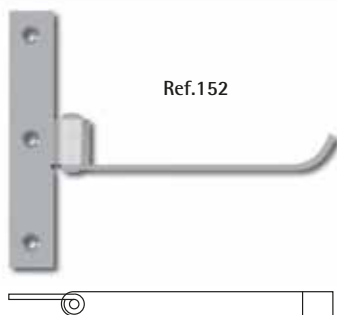
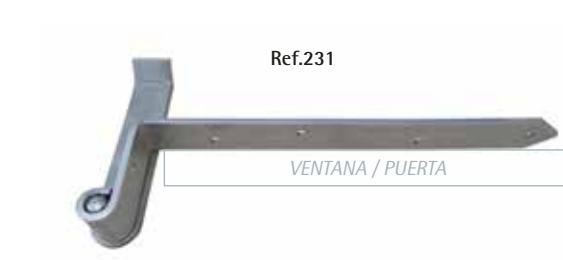



Ref./Cod.	Descripción Name Dénomination	mm Medidas Size Dimension
600/4099	Correa Suelta / <i>Single strap hinge</i> / Penture droite	40x200x4
600/4100	Correa Suelta / <i>Single strap hinge</i> / Penture droite	40x300x4
600/4101	Base encaje obra / <i>Gate hanger for brick work</i> / Gond à sceller	25x140x5
600/4102	Base placa atornillada / <i>Gate hanger on square plate</i> / Gond sur platine	120x40x4
600/4103	Base tirafondo / <i>Gate pin to screw</i> / Gond à vis	75x8

Materiales- (Acabados) / *Materials- (Treatments)* / Matériaux- (Finitions)

H (BRI) - (PING)



600/4099 - 600/4095



600/4101



600/4103

600/4102



Ref./Cod.	mm Medidas Size Dimension	Agujeros x ømm Holes Trou	Ø Tornillo Screw Vis
600/4094	40x200x4	6x5	4,5x25
600/4095	40x300x4	7x5	4,5x25

Materiales- (Acabados) / *Materials- (Treatments)* / Matériaux- (Finitions)

H (BRI) - (PING)



Ref./Cod.	mm Medidas Size Dimension	Agujeros x ømm Holes Trou	Ø Tornillo Screw Vis
600/4091	40x200x4	4x5	4,5x25
600/4092	40x300x4	6x5	4,5x25
600/4093	40x400x4	6x5	4,5x25

Materiales- (Acabados) / *Materials- (Treatments)* / Matériaux- (Finitions)

H (BRI) - (PING)



Doble hoja - Double sheet - Double feuille

Ref.146-Mod.553



Ref./Cod.	mm Medidas Size Dimension	Agujeros x ømm Holes Trou	Ø Tornillo Screw Vis
146/226	50x40x1.8	6x4.5	3.5x20
146/228	60x50x2	6x5	4x20
146/230	70x60x2	6x5	4.5x25
146/232	80x70x2.2	6x6	5x25
146/233	90x80x2.4	6x6	5x25
146/234	100x80x3	8x6	5x25
146/235	100x100x3	6x6	5x25
146/236	120x80x3	8x6	5x25

Variantes / Variants / Variantes



Materiales- (Acabados) / Materials- (Treatments) / Matériaux- (Finitions)

H	(PU) - (ZI) - (LA)
L	(PU)
I304	(B)



Tipo mahonesas - Mahon type - Type mahonnaise

Ref.148-Mod.550



Ref./Cod.	mm Medidas Size Dimension	Agujeros x ømm Holes Trou	Ø Tornillo Screw Vis
148/241	40x35x1.5	4x3.5	3x16
148/242	50x40x1.5	4x4	3.5x20
148/243	62x45x2	6x5	4x20
148/244	75x60x2.4	6x5	4.5x25
148/245	89x68x2.4	6x6	5x25
148/246	100x80x3	6x6.5	5x25

Variantes / Variants / Variantes



Características/ Characteristics/ Caractéristiques

Bisagra quita y pon con pasador de latón.
Lift-off hinge with brass pin.
Paumelles avec broche en laiton.

Materiales- (Acabados) / Materials- (Treatments) / Matériaux- (Finitions)

L	(PU)
I304	(B)



Ref./Cod.	mm Medidas Size Dimension	H	Agujeros x ømm Holes Trou	Ø Tornillo Screw Vis
147/1056	45x70x3	2	4x5.5	4.5x25
147/1058	80x120x3	2	10x5.5	4.5x25
147/1163	80x50x3	2	6x5.5	4.5x25

* H= Holgura entre los nudos / Axial between the tubbers / Entre les tubbers axiale

Materiales- (Acabados) / Materials- (Treatments) / Matériaux- (Finitions)

H (PU) - (ZI) - (LA) - (BRI)

L (PU)

I304 (B)



Ref./Cod.	mm Medidas Size Dimension	H	Agujeros x ømm Holes Trou	Ø Tornillo Screw Vis
147/1704	45x90x3	-	4x5.5	4.5x25
147/931	50x50x2.4	2	4x5.5	4.5x25
147/1288	50x50x2.4	10	4x5.5	4.5x25
147/939	60x60x3	10	6x5	4.5x25
147/938	60x60x3	2	6x5	4.5x25
147/237	70x55x3	10	6x5	4.5x25
147/238	70x55x3	2	6x5	4.5x25
147/239	60x90x3	10	8x5	4.5x25
147/240	60x90x3	2	8x5	4.5x25
147/1464	60x120x3	-	8x5	4.5x25
147/1702	100x175x4	-	8x5	4.5x25
147/1701	100x100x4	-	6x5	4.5x25
147/1699	50x105x3	-	6x5	4.5x25
147/1700	50x105x3	-	6x5	4.5x25
147/1478	50x100x3	-	6x5	4.5x25
147/1479	50x100x3	-	6x5	4.5x25
147/1480	50x50x3	-	6x5	4.5x25
147/1481	50x50x3	-	6x5	4.5x25
147/1482	50x100x3	-	6x5	4.5x25

* H= Holgura entre los nudos / Axial between the tubbers / Entre les tubbers axiale

Materiales- (Acabados) / Materials- (Treatments) / Matériaux- (Finitions)

H (PU) - (ZI) - (LA) - (BRI)

L (PU)

I304 (B)



Doble hoja - Double sheet - Double feuille

Ref.54-Mod.553



Ref./Cod.	mm Medidas Size Dimension	Agujeros x ømm Holes Trou	Ø Tornillo Screw Vis	
54/2036	30x30x1.4	4x3.5	3x16	
54/2037	40x40x1.6	6x3.5	3x16	
54/2038	50x40x1.6	6x3.5	3x16	
54/2039	50x50x1.6	6x3.5	3.5x20	
54/2040	60x50x2	6x5	3.5x20	
54/2041	60x60x2	6x5	4x25	
54/2042	70x50x2	6x5	4x25	
54/2043	70x60x2	6x5	4x25	
54/2044	70x70x2	6x5	4x25	
54/2045	80x60x2	6x5	4x25	
54/2046	80x70x2	6x5	4x25	
54/2047	80x80x2	6x5	4x25	
54/2048	90x80x2.4	6x6	4x25	
54/2049	90x90x2.4	6x5.5	4.5x25	
54/2050	100x80x3	6x5.5	4.5x25	
54/2052	100x100x3	8x5.5	4.5x25	
54/2053	110x110x3	8x5.5	4.5x25	
54/2054	120x120x3	8x5.5	4.5x25	
54/2055	130x130x3	10x5.5	4.5x25	
54/2258	140x140x3	10x5.5	4.5x25	

Variantes / Variants / Variantes



Materiales- (Acabados) / Materials- (Treatments) / Matériaux- (Finitions)

H (PU) - (ZI)

Doble hoja persiana - Double sheet blind - Double feuille volet

Ref.54-Mod.553-A



Ref./Cod.	mm Medidas Size Dimension	Agujeros x ømm Holes Trou	Ø Tornillo Screw Vis	
54/2077	80x60x2.4	6x5	4x25	
54/2078	80x70x2.4	6x5	4x25	
54/2079	80x75x2.4	6x5	4x25	
54/2080	80x80x2.4	6x5	4x25	
54/2081	80x90x2.4	6x5	4x25	
54/2082	80x100x2.4	6x5	4x25	
54/2084	80x120x2.4	6x5	4x25	
54/7502	Pasador ø6		Por separado	

Variantes / Variants / Variantes



Materiales- (Acabados) / Materials- (Treatments) / Matériaux- (Finitions)

H (ZI)

Doble hoja pollaguera - *Double sheet polleguera* - Double feuille polleguera

Ref./Cod.	Descripción Description Description	mm Medidas Size Dimension	Agujeros x ømm Holes Trou	Ø Tornillo Screw Vis
61/2185	Bisagra + Escuadra <i>Hinge + Bracket</i> <i>Charnière + Équerre</i>	80x60x2,4	6x5	3,5x20
61/4312	Escuadra suelta <i>Only bracket</i> <i>Équerre</i>	50x43x27,5x3	3x5,5	4x25



Materiales- (Acabados) / *Materials- (Treatments)* / *Matériaux- (Finitions)*

H (ZI)

Bisagras tipo ramal doble hoja - *Strap hinges* - Charnières forme oblongue

Ref./Cod.	mm Medidas Size Dimension	Agujeros x ømm Holes Trou	Ø Tornillo Screw Vis
115/091	20x90x2,6	4x5	4x20
115/092	20x140x3,4	4x5	4x20
115/093	20x200x5	6x6,5	5x25
115/094	20x300x5	6x6,5	5x25



Materiales- (Acabados) / *Materials- (Treatments)* / *Matériaux- (Finitions)*

H (PU) - (LA) - (ZI) - (BRI)

Bisagras tipo ramal doble hoja - *Strap hinges* - Charnières forme oblongue

Ref./Cod.	mm Medidas Size Dimension	Agujeros x ømm Holes Trou	Ø Tornillo Screw Vis
78/2227	30x100x3	8x4,5	3,5x20
78/2228	30x150x3	6x5,5	4,5x25
78/2229	30x200x3	6x5,5	4,5x25
78/2230	30x250x3	6x5,5	4,5x25
78/2231	35x300x3	6x5,5	4,5x25



Materiales- (Acabados) / *Materials- (Treatments)* / *Matériaux- (Finitions)*

H (PU) - (ZI)

BISAGRAS DE PIANO
CONTINUOUS PIANO HINGES
CHARNIÈRES À PIANO

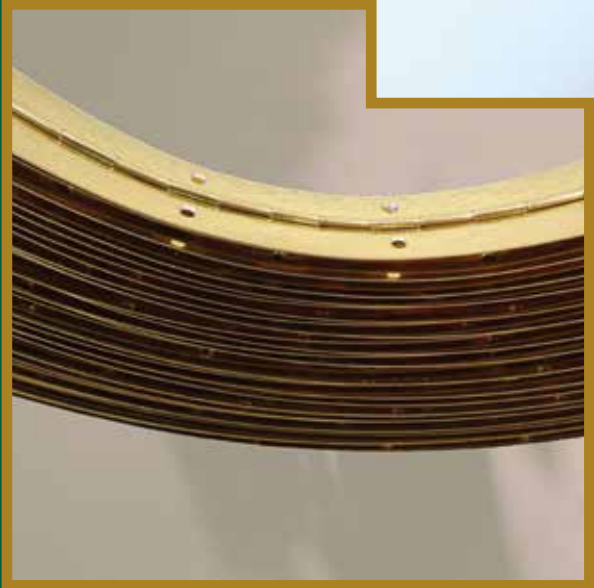

Piano (de grueso 0.7 mm) - Piano (0.7 mm thickness) - Piano (0.7 mm d'épaisseur) Pasador - Pin - Axe = Ø 1.7mm

Ref. 140

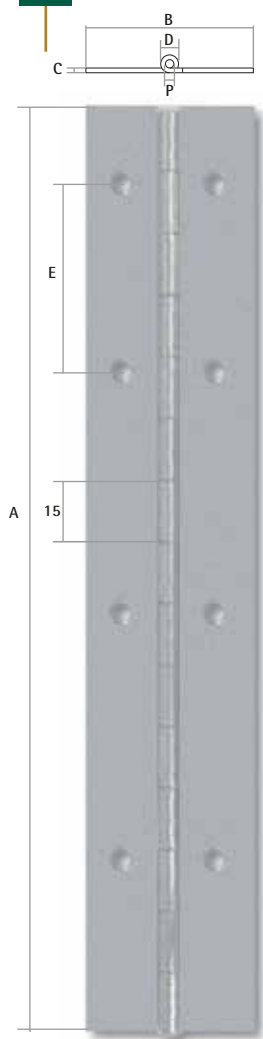

Ref./Cod.	mm Medidas Size Dimension BxCxA	P	D	E	ømm	Agujeros Holes Trou	Ø Tornillo Screw Vis	
140/3000	20x0.7x1000	1.70	2.1	60.4	3	2.5x12		
140/3001	20x0.7x1500	1.70	2.1	60.4	3	2.5x12		
140/3002	20x0.7x2000	1.70	2.1	60.4	3	2.5x12		
140/3003	20x0.7x2500	1.70	2.1	60.4	3	2.5x12		
140/3004	20x0.7x3000	1.70	2.1	60.4	3	2.5x12		
140/3005	20x0.7x3500	1.70	2.1	60.4	3	2.5x12		
140/3006	25x0.7x1000	1.70	2.1	60.4	3	2.5x12		
140/3007	25x0.7x1500	1.70	2.1	60.4	3	2.5x12		
140/3008	25x0.7x2000	1.70	2.1	60.4	3	2.5x12		
140/3009	25x0.7x2500	1.70	2.1	60.4	3	2.5x12		
140/3010	25x0.7x3000	1.70	2.1	60.4	3	2.5x12		
140/3011	25x0.7x3500	1.70	2.1	60.4	3	2.5x12		
140/3012	32x0.7x1000	1.70	2.1	60.4	3	2.5x12		
140/3013	32x0.7x1500	1.70	2.1	60.4	3	2.5x12		
140/3014	32x0.7x2000	1.70	2.1	60.4	3	2.5x12		
140/3015	32x0.7x2500	1.70	2.1	60.4	3	2.5x12		
140/3016	32x0.7x3000	1.70	2.1	60.4	3	2.5x12		
140/3017	32x0.7x3500	1.70	2.1	60.4	3	2.5x12		
140/3018	40x0.7x1000	1.70	2.1	60.4	3	2.5x12		
140/3019	40x0.7x1500	1.70	2.1	60.4	3	2.5x12		
140/3020	40x0.7x2000	1.70	2.1	60.4	3	2.5x12		
140/3021	40x0.7x2500	1.70	2.1	60.4	3	2.5x12		
140/3022	40x0.7x3000	1.70	2.1	60.4	3	2.5x12		
140/3023	40x0.7x3500	1.70	2.1	60.4	3	2.5x12		

Variantes / Variants / Variantes



Materiales - (Acabados) /
Materials - (Treatments) /
Matériaux - (Finitions)

	(LA) - (NI)
	(B)
	(B)

Se sirve en tiras de longitud máxima de 3,5 m. Para anchos y largos especiales, consultar.
Supplied in 3-metre maximum lengths. Consult for special widths and lengths.

Est fourni en bandes d'une longueur maximum de 3 m. Pour des largeurs et des longueurs spéciales, consulter.

Piano en tiras con colgador (de grueso 0.7 mm) - Piano hinge strips (0.7 mm thickness) - Charnières de piano en lanières (0.7 mm d'épaisseur)

Ref. 140



Ref./Cod.	mm Medidas Size Dimension BxCxA	P	D	E	ømm	Agujeros Holes Trou	Ø Tornillo Screw Vis	
140/1683	32x0.7x400	1.70	2.1	60.4	3	2.5x12		
140/1680	32x0.7x600	1.70	2.1	60.4	3	2.5x12		
140/1677	32x0.7x750	1.70	2.1	60.4	3	2.5x12		
140/1674	32x0.7x900	1.70	2.1	60.4	3	2.5x12		
140/1617	32x0.7x1000	1.70	2.1	60.4	3	2.5x12		

Materiales- (Acabados) / Materials- (Treatments) / Matériaux- (Finitions)

	(LA) - (NI)
	(B)

Se sirven con tornillos de montaje y colgador.

Supplied with screws and clip.

Servi avec vis et clip.



Ref.143

Rollo de piano (de grueso 1.5 mm) - Roll of piano (1.5 mm thickness) - Rouleaux de piano avec trous (1.5 mm d'épaisseur)

Variantes / Variants / Variantes



Se sirve en rollos de 50 metros.
Service 50 meters roll.
Service en rouleaux de 50 mètres.

Ref./Cod.	mm Medidas Size Dimension BxC	P	D	E	ømm	Agujeros Holes Trou	Ø Tornillo Screw Vis	
140/194	20x0.7	1.70	2.1	60.4	3	2.5x12		
140/195	25x0.7	1.70	2.1	60.4	3	2.5x12		
140/196	32x0.7	1.70	2.1	60.4	3	2.5x12		
140/197	40x0.7	1.70	2.1	60.4	3	2.5x12		



Materiales- (Acabados) / Materials- (Treatments) / Matériaux- (Finitions)

H (LA) - (NI)

L (B)

I304 (B)

Piano (de grueso 1 mm) - Piano (1 mm thickness) - Piano (1 mm d'épaisseur) Pasador - Pin - Axe = Ø 2mm

Ref.141

Variantes / Variants / Variantes

Materiales- (Acabados) /
Materials- (Treatments) /
Matériaux- (Finitions)

H (PU)

L (B)

I304 I316 (B)

Ref./Cod.	mm Medidas Size Dimension BxCxA	P	D	E	ømm	Agujeros Holes Trou	Ø Tornillo Screw Vis	
141/3024	25x1x1000	2	4	60	3	3x16		
141/3025	25x1x1500	2	4	60	3	3x16		
141/3026	25x1x2000	2	4	60	3	3x16		
141/3027	25x1x2500	2	4	60	3	3x16		
141/3028	25x1x3000	2	4	60	3	3x16		
141/3029	25x1x3500	2	4	60	3	3x16		
141/3030	32x1x1000	2	4	60	3	3x16		
141/3031	32x1x1500	2	4	60	3	3x16		
141/3032	32x1x2000	2	4	60	3	3x16		
141/3033	32x1x2500	2	4	60	3	3x16		
141/3034	32x1x3000	2	4	60	3	3x16		
141/3035	32x1x3500	2	4	60	3	3x16		
141/3036	40x1x1000	2	4	60	3	3x16		
141/3037	40x1x1500	2	4	60	3	3x16		
141/3038	40x1x2000	2	4	60	3	3x16		
141/3039	40x1x2500	2	4	60	3	3x16		
141/3040	40x1x3000	2	4	60	3	3x16		
141/3041	40x1x3500	2	4	60	3	3x16		
141/3042	50x1x1000	2	4	60	3	3x16		
141/3043	50x1x1500	2	4	60	3	3x16		
141/3044	50x1x2000	2	4	60	3	3x16		
141/3045	50x1x2500	2	4	60	3	3x16		
141/3046	50x1x3000	2	4	60	3	3x16		
141/3047	50x1x3500	2	4	60	3	3x16		
141/3048	60x1x1000	2	4	60	3	3x16		
141/3049	60x1x1500	2	4	60	3	3x16		
141/3050	60x1x2000	2	4	60	3	3x16		
141/3051	60x1x2500	2	4	60	3	3x16		
141/3052	60x1x3000	2	4	60	3	3x16		
141/3053	60x1x3500	2	4	60	3	3x16		

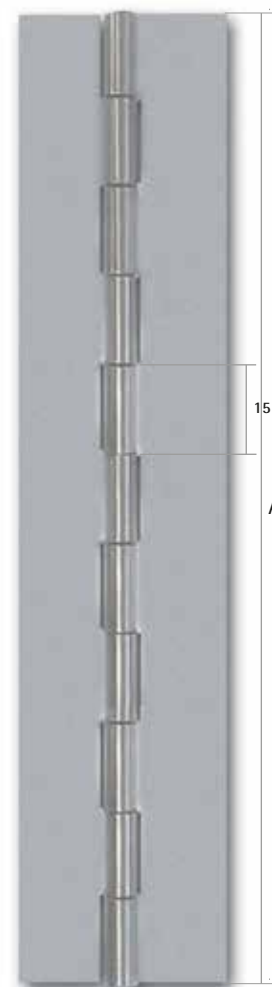
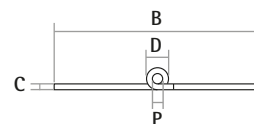



Se sirve en tiras de longitud máxima de 3,5 m. Para anchos y largos especiales, consultar.
Supplied in 3-metre maximum lengths. Consult for special widths and lengths.

Est fourni en bandes d'une longueur maximum de 3 m. Pour des largeurs et des longueurs spéciales, consulter.

Piano (de grueso 1.2 mm) - Piano (1.2 mm thickness) - Piano (1.2 mm d'épaisseur)
Pasador - Pin - Axe = Ø 3mm

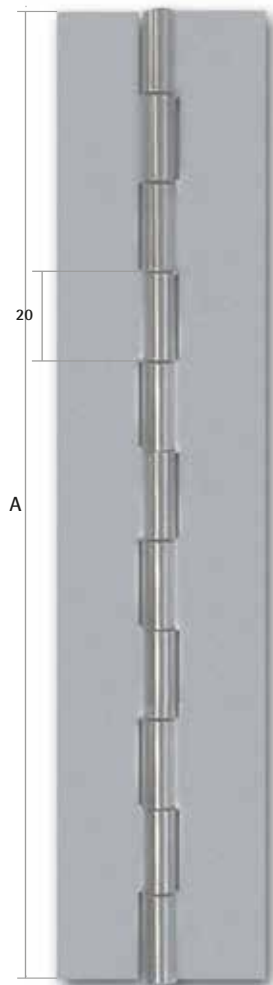
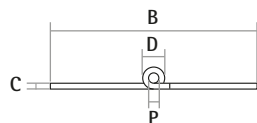
Ref. 451







Ref./Cod.	mm Medidas Size Dimension BxCxA	P	D	E	ømm	Agujeros Holes Trou	Ø Tornillo Screw Vis	
451/3084	25x1.2x1000	3	5.5	60	4	4	3x16	
451/3085	25x1.2x1500	3	5.5	60	4	4	3x16	
451/3086	25x1.2x2000	3	5.5	60	4	4	3x16	
451/3087	25x1.2x2500	3	5.5	60	4	4	3x16	
451/3088	25x1.2x3000	3	5.5	60	4	4	3x16	
451/3089	25x1.2x3500	3	5.5	60	4	4	3x16	
451/3090	32x1.2x1000	3	5.5	60	4	4	3x16	
451/3091	32x1.2x1500	3	5.5	60	4	4	3x16	
451/3092	32x1.2x2000	3	5.5	60	4	4	3x16	
451/3093	32x1.2x2500	3	5.5	60	4	4	3x16	
451/3094	32x1.2x3000	3	5.5	60	4	4	3x16	
451/3095	32x1.2x3500	3	5.5	60	4	4	3x16	
451/3096	40x1.2x1000	3	5.5	60	4	4	3x16	
451/3097	40x1.2x1500	3	5.5	60	4	4	3x16	
451/3098	40x1.2x2000	3	5.5	60	4	4	3x16	
451/3099	40x1.2x2500	3	5.5	60	4	4	3x16	
451/3100	40x1.2x3000	3	5.5	60	4	4	3x16	
451/3101	40x1.2x3500	3	5.5	60	4	4	3x16	
451/3102	50x1.2x1000	3	5.5	60	4	4	3x16	
451/3103	50x1.2x1500	3	5.5	60	4	4	3x16	
451/3104	50x1.2x2000	3	5.5	60	4	4	3x16	
451/3105	50x1.2x2500	3	5.5	60	4	4	3x16	
451/3106	50x1.2x3000	3	5.5	60	4	4	3x16	
451/3107	50x1.2x3500	3	5.5	60	4	4	3x16	
451/3108	60x1.2x1000	3	5.5	60	4	4	3x16	
451/3109	60x1.2x1500	3	5.5	60	4	4	3x16	
451/3110	60x1.2x2000	3	5.5	60	4	4	3x16	
451/3111	60x1.2x2500	3	5.5	60	4	4	3x16	
451/3112	60x1.2x3000	3	5.5	60	4	4	3x16	
451/3113	60x1.2x3500	3	5.5	60	4	4	3x16	

Variantes / Variants / Variantes



Materiales- (Acabados) / Materials- (Treatments) / Matériaux- (Finitions)

-  H (PU)
-  L (B)
-  I304  I316 (B)

Se sirve en tiras de longitud máxima de 3,5 m. Para anchos y largos especiales, consultar.
Supplied in 3-metre maximum lengths. Consult for special widths and lengths.
Est fourni en bandes d'une longueur maximum de 3 m. Pour des largeurs et des longueurs spéciales, consulter.

Piano (de grueso 1.5 mm) - *Piano (1.5 mm thickness)* - Piano (1.5 mm d'épaisseur)

Ref.143 Pasador - Pin - Axe = Ø 3mm

Variantes / Variants / Variantes



Ref./Cod.	mm Medidas Size Dimension BxCxA	P	D	E	ømm	Agujeros Holes Trou	Ø Tornillo Screw Vis	
143/3114	32x1.5x1000	3	6	60	4	4	3.5x20	
143/3115	32x1.5x1500	3	6	60	4	4	3.5x20	
143/3116	32x1.5x2000	3	6	60	4	4	3.5x20	
143/3117	32x1.5x2500	3	6	60	4	4	3.5x20	
143/3118	32x1.5x3000	3	6	60	4	4	3.5x20	
143/3119	32x1.5x3500	3	6	60	4	4	3.5x20	
143/3120	40x1.5x1000	3	6	60	4	4	3.5x20	
143/3121	40x1.5x1500	3	6	60	4	4	3.5x20	
143/3122	40x1.5x2000	3	6	60	4	4	3.5x20	
143/3123	40x1.5x2500	3	6	60	4	4	3.5x20	
143/3124	40x1.5x3000	3	6	60	4	4	3.5x20	
143/3125	40x1.5x3500	3	6	60	4	4	3.5x20	
143/3126	50x1.5x1000	3	6	60	4	4	3.5x20	
143/3127	50x1.5x1500	3	6	60	4	4	3.5x20	
143/3128	50x1.5x2000	3	6	60	4	4	3.5x20	
143/3129	50x1.5x2500	3	6	60	4	4	3.5x20	
143/3130	50x1.5x3000	3	6	60	4	4	3.5x20	
143/3131	50x1.5x3500	3	6	60	4	4	3.5x20	
143/3132	60x1.5x1000	3	6	60	4	4	3.5x20	
143/3133	60x1.5x1500	3	6	60	4	4	3.5x20	
143/3134	60x1.5x2000	3	6	60	4	4	3.5x20	
143/3135	60x1.5x2500	3	6	60	4	4	3.5x20	
143/3136	60x1.5x3000	3	6	60	4	4	3.5x20	
143/3137	60x1.5x3500	3	6	60	4	4	3.5x20	
143/3138	70x1.5x1000	3	6	60	4	4	3.5x20	
143/3139	70x1.5x1500	3	6	60	4	4	3.5x20	
143/3140	70x1.5x2000	3	6	60	4	4	3.5x20	
143/3141	70x1.5x2500	3	6	60	4	4	3.5x20	
143/3142	70x1.5x3000	3	6	60	4	4	3.5x20	
143/3143	70x1.5x3500	3	6	60	4	4	3.5x20	
143/3144	80x1.5x1000	3	6	60	4	4	3.5x20	
143/3145	80x1.5x1500	3	6	60	4	4	3.5x20	
143/3146	80x1.5x2000	3	6	60	4	4	3.5x20	
143/3147	80x1.5x2500	3	6	60	4	4	3.5x20	
143/3148	80x1.5x3000	3	6	60	4	4	3.5x20	
143/3149	80x1.5x3500	3	6	60	4	4	3.5x20	

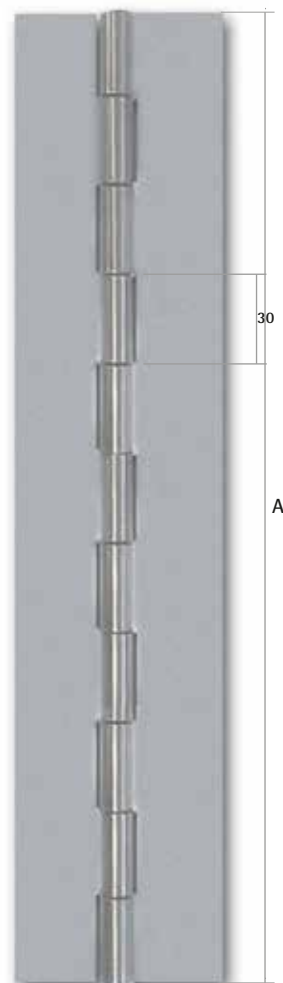
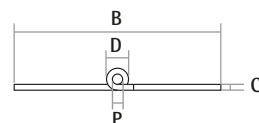

Materiales- (Acabados) / Materials- (Treatments) / Matériaux- (Finitions)

- H (LA) - (NI)
- L (B)
- I304 I316 (B)

Se sirve en tiras de longitud máxima de 3,5 m. Para anchos y largos especiales, consultar.
 Supplied in 3-metre maximum lengths. Consult for special widths and lengths.
 Est fourni en bandes d'une longueur maximum de 3 m. Pour des largeurs et des longueurs spéciales, consulter.

Piano (de grueso 1.5 mm) - Piano (1.5 mm thickness) - Piano (1.5 mm d'épaisseur)
Pasador - Pin - Axe = Ø 4mm

Ref. 164

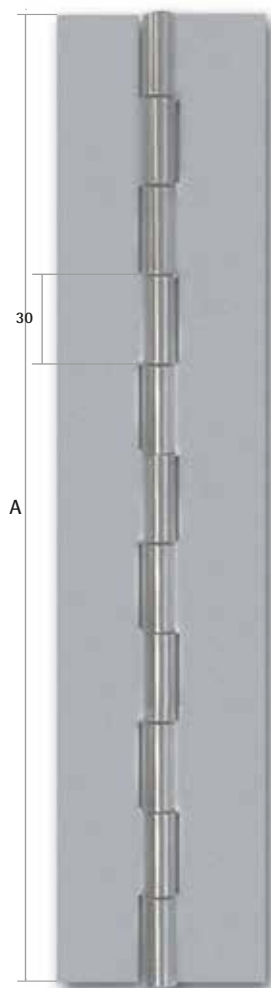
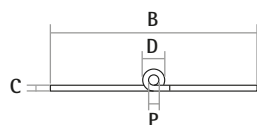

Ref./Cod.	mm Medidas Size Dimension BxCxA	P	D	E	Ømm	Agujeros Holes Trou	Ø Tornillo Screw Vis	
164/3150	40x1.5x1000	4	7	60	4	4	3.5x20	
164/3151	40x1.5x1500	4	7	60	4	4	3.5x20	
164/3152	40x1.5x2000	4	7	60	4	4	3.5x20	
164/3153	40x1.5x2500	4	7	60	4	4	3.5x20	
164/3154	40x1.5x3000	4	7	60	4	4	3.5x20	
164/3155	40x1.5x3500	4	7	60	4	4	3.5x20	
164/3156	50x1.5x1000	4	7	60	4	4	3.5x20	
164/3157	50x1.5x1500	4	7	60	4	4	3.5x20	
164/3158	50x1.5x2000	4	7	60	4	4	3.5x20	
164/3159	50x1.5x2500	4	7	60	4	4	3.5x20	
164/3160	50x1.5x3000	4	7	60	4	4	3.5x20	
164/3161	50x1.5x3500	4	7	60	4	4	3.5x20	
164/3162	60x1.5x1000	4	7	60	4	4	3.5x20	
164/3163	60x1.5x1500	4	7	60	4	4	3.5x20	
164/3164	60x1.5x2000	4	7	60	4	4	3.5x20	
164/3165	60x1.5x2500	4	7	60	4	4	3.5x20	
164/3166	60x1.5x3000	4	7	60	4	4	3.5x20	
164/3167	60x1.5x3500	4	7	60	4	4	3.5x20	
164/3168	70x1.5x1000	4	7	60	4	4	3.5x20	
164/3169	70x1.5x1500	4	7	60	4	4	3.5x20	
164/3170	70x1.5x2000	4	7	60	4	4	3.5x20	
164/3171	70x1.5x2500	4	7	60	4	4	3.5x20	
164/3172	70x1.5x3000	4	7	60	4	4	3.5x20	
164/3173	70x1.5x3500	4	7	60	4	4	3.5x20	
164/3174	80x1.5x1000	4	7	60	4	4	3.5x20	
164/3175	80x1.5x1500	4	7	60	4	4	3.5x20	
164/3176	80x1.5x2000	4	7	60	4	4	3.5x20	
164/3177	80x1.5x2500	4	7	60	4	4	3.5x20	
164/3178	80x1.5x3000	4	7	60	4	4	3.5x20	
164/3179	80x1.5x3500	4	7	60	4	4	3.5x20	
164/3180	100x1.5x1000	4	7	60	4	4	3.5x20	
164/3181	100x1.5x1500	4	7	60	4	4	3.5x20	
164/3182	100x1.5x2000	4	7	60	4	4	3.5x20	
164/3183	100x1.5x2500	4	7	60	4	4	3.5x20	
164/3184	100x1.5x3000	4	7	60	4	4	3.5x20	
164/3185	100x1.5x3500	4	7	60	4	4	3.5x20	

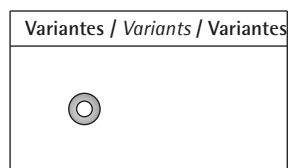

Materiales- (Acabados) / Materials- (Treatments) / Matériaux- (Finitions)

- H (PU)
- L (B)
- I304 I316 (B)

Se sirve en tiras de longitud máxima de 3,5 m. Para anchos y largos especiales, consultar.
Supplied in 3-metre maximum lengths. Consult for special widths and lengths.
Est fourni en bandes d'une longueur maximum de 3 m. Pour des largeurs et des longueurs spéciales, consulter.

Piano (de grueso 1.5 mm) - *Piano (1.5 mm thickness)* - Piano (1.5 mm d'épaisseur)
Pasador - *Pin - Axe = Ø 5mm*

Ref.470

Variantes / *Variants* / Variantes



Ref./Cod.	mm Medidas Size Dimension BxCxA	P	D	E	Ømm	Agujeros Holes Trou	Ø Tornillo Screw Vis	
470/4337	40x1.5x1000	5	8	60	5	5	3.5x20	
470/4338	40x1.5x1500	5	8	60	5	5	3.5x20	
470/4339	40x1.5x2000	5	8	60	5	5	3.5x20	
470/4340	40x1.5x2500	5	8	60	5	5	3.5x20	
470/4341	40x1.5x3000	5	8	60	5	5	3.5x20	
470/4342	40x1.5x3500	5	8	60	5	5	3.5x20	
470/4343	50x1.5x1000	5	8	60	5	5	3.5x20	
470/4344	50x1.5x1500	5	8	60	5	5	3.5x20	
470/4345	50x1.5x2000	5	8	60	5	5	3.5x20	
470/4346	50x1.5x2500	5	8	60	5	5	3.5x20	
470/4347	50x1.5x3000	5	8	60	5	5	3.5x20	
470/4348	50x1.5x3500	5	8	60	5	5	3.5x20	
470/4349	60x1.5x1000	5	8	60	5	5	3.5x20	
470/4350	60x1.5x1500	5	8	60	5	5	3.5x20	
470/4351	60x1.5x2000	5	8	60	5	5	3.5x20	
470/4352	60x1.5x2500	5	8	60	5	5	3.5x20	
470/4353	60x1.5x3000	5	8	60	5	5	3.5x20	
470/4354	60x1.5x3500	5	8	60	5	5	3.5x20	
470/4355	70x1.5x1000	5	8	60	5	5	3.5x20	
470/4356	70x1.5x1500	5	8	60	5	5	3.5x20	
470/4357	70x1.5x2000	5	8	60	5	5	3.5x20	
470/4358	70x1.5x2500	5	8	60	5	5	3.5x20	
470/4359	70x1.5x3000	5	8	60	5	5	3.5x20	
470/4360	70x1.5x3500	5	8	60	5	5	3.5x20	
470/4361	80x1.5x1000	5	8	60	5	5	3.5x20	
470/4362	80x1.5x1500	5	8	60	5	5	3.5x20	
470/4363	80x1.5x2000	5	8	60	5	5	3.5x20	
470/4364	80x1.5x2500	5	8	60	5	5	3.5x20	
470/4365	80x1.5x3000	5	8	60	5	5	3.5x20	
470/4366	80x1.5x3500	5	8	60	5	5	3.5x20	
470/4367	100x1.5x1000	5	8	60	5	5	3.5x20	
470/4368	100x1.5x1500	5	8	60	5	5	3.5x20	
470/4369	100x1.5x2000	5	8	60	5	5	3.5x20	
470/4370	100x1.5x2500	5	8	60	5	5	3.5x20	
470/4371	100x1.5x3000	5	8	60	5	5	3.5x20	
470/4372	100x1.5x3500	5	8	60	5	5	3.5x20	

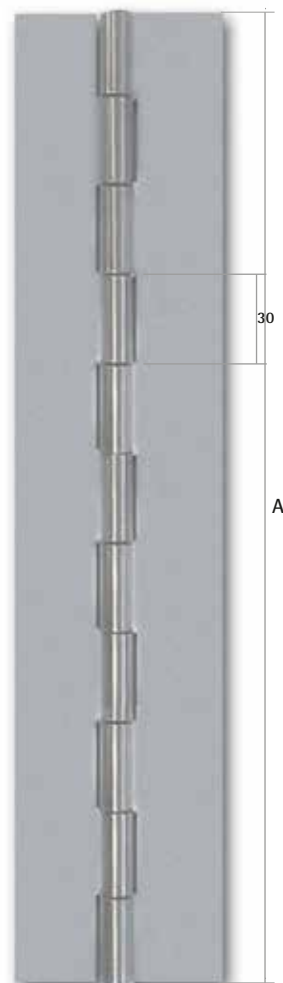
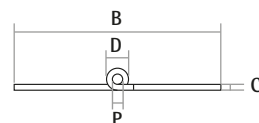

Materiales- (Acabados) / *Materials- (Treatments)* / Matériaux- (Finitions)

 (LA) - (NI)

 (B)

 1304  1316 (B)

Se sirve en tiras de longitud máxima de 3,5 m. Para anchos y largos especiales, consultar.

Supplied in 3-metre maximum lengths. Consult for special widths and lengths.

Est fourni en bandes d'une longueur maximum de 3 m. Pour des largeurs et des longueurs spéciales, consulter.

Piano Especial Palet (de grueso 1.5 mm) - Special Piano Hinges (1.5 mm thickness) - Piano Spéciaux (1.5 mm d'épaisseur)

Ref. 143



Ref./Cod.	mm Medidas Size Dimension BxCxA
143/4559	107x1.5x220
143/2057	107x1.5x418
143/4298	107x1.5x418

Materiales / Materials / Matériaux

H (Zl)
I304 (B)

Para anchos y largos especiales consultar
If special length/width is needed, feel free to contact us
Si vous cherchez des longueurs/largeurs spéciaux, contactez-nous



Piano (de grueso 2 mm) - Piano (2 mm thickness) - Piano (2 mm d'épaisseur) Pasador - Pin - Axe = Ø 4mm

Ref. 497

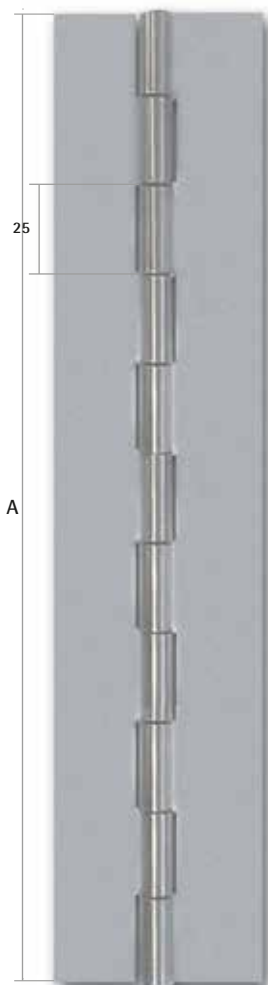
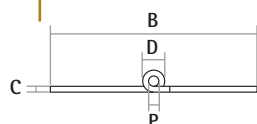

Ref./Cod.	mm Medidas Size Dimension BxCxA	P	D	E	Ømm	Agujeros Holes Trou	Ø Tornillo Screw Vis
497/4313	40x2x1000	4	8	60	5	5	3.5x20
497/4314	40x2x1500	4	8	60	5	5	3.5x20
497/4315	40x2x2000	4	8	60	5	5	3.5x20
497/4316	40x2x2500	4	8	60	5	5	3.5x20
497/4317	40x2x3000	4	8	60	5	5	3.5x20
497/4318	40x2x3500	4	8	60	5	5	3.5x20
497/4319	50x2x1000	4	8	60	5	5	3.5x20
497/4320	50x2x1500	4	8	60	5	5	3.5x20
497/4321	50x2x2000	4	8	60	5	5	3.5x20
497/4322	50x2x2500	4	8	60	5	5	3.5x20
497/4323	50x2x3000	4	8	60	5	5	3.5x20
497/4324	50x2x3500	4	8	60	5	5	3.5x20
497/4325	60x2x1000	4	8	60	5	5	3.5x20
497/4326	60x2x1500	4	8	60	5	5	3.5x20
497/4327	60x2x2000	4	8	60	5	5	3.5x20
497/4328	60x2x2500	4	8	60	5	5	3.5x20
497/4329	60x2x3000	4	8	60	5	5	3.5x20
497/4330	60x2x3500	4	8	60	5	5	3.5x20
497/4331	80x2x1000	4	8	60	5	5	3.5x20
497/4332	80x2x1500	4	8	60	5	5	3.5x20
497/4333	80x2x2000	4	8	60	5	5	3.5x20
497/4334	80x2x2500	4	8	60	5	5	3.5x20
497/4335	80x2x3000	4	8	60	5	5	3.5x20
497/4336	80x2x3500	4	8	60	5	5	3.5x20

Variantes / Variants / Variantes



Materiales- (Acabados) / Materials- (Treatments) / Matériaux- (Finitions)

H (PU)
L (B)
I304 **I316** (B)

Se sirve en tiras de longitud máxima de 3,5 m. Para anchos y largos especiales, consultar.
Supplied in 3-metre maximum lengths. Consult for special widths and lengths.
Est fourni en bandes d'une longueur maximum de 3 m. Pour des largeurs et des longueurs spéciales, consulter.

Piano (de grueso 2 mm) - Piano (2 mm thickness) - Piano (2 mm d'épaisseur)
Pasador - Pin - Axe = Ø 6mm

Ref.144

Variantes / Variants / Variantes



Ref./Cod.	mm Medidas Size Dimension BxCxA	P	D	E	ømm	Agujeros Holes Trou	Ø Tornillo Screw Vis	
144/3186	45x2x1000	6	10	60	5	5	3.5x20	
144/3187	45x2x1500	6	10	60	5	5	3.5x20	
144/3188	45x2x2000	6	10	60	5	5	3.5x20	
144/3189	45x2x2500	6	10	60	5	5	3.5x20	
144/3190	45x2x3000	6	10	60	5	5	3.5x20	
144/3191	45x2x3500	6	10	60	5	5	3.5x20	
144/3192	50x2x1000	6	10	60	5	5	3.5x20	
144/3193	50x2x1500	6	10	60	5	5	3.5x20	
144/3194	50x2x2000	6	10	60	5	5	3.5x20	
144/3195	50x2x2500	6	10	60	5	5	3.5x20	
144/3196	50x2x3000	6	10	60	5	5	3.5x20	
144/3197	50x2x3500	6	10	60	5	5	3.5x20	
144/3198	60x2x1000	6	10	60	5	5	3.5x20	
144/3199	60x2x1500	6	10	60	5	5	3.5x20	
144/3200	60x2x2000	6	10	60	5	5	3.5x20	
144/3201	60x2x2500	6	10	60	5	5	3.5x20	
144/3202	60x2x3000	6	10	60	5	5	3.5x20	
144/3203	60x2x3500	6	10	60	5	5	3.5x20	
144/3204	70x2x1000	6	10	60	5	5	3.5x20	
144/3205	70x2x1500	6	10	60	5	5	3.5x20	
144/3206	70x2x2000	6	10	60	5	5	3.5x20	
144/3207	70x2x2500	6	10	60	5	5	3.5x20	
144/3208	70x2x3000	6	10	60	5	5	3.5x20	
144/3209	70x2x3500	6	10	60	5	5	3.5x20	
144/3210	80x2x1000	6	10	60	5	5	3.5x20	
144/3211	80x2x1500	6	10	60	5	5	3.5x20	
144/3212	80x2x2000	6	10	60	5	5	3.5x20	
144/3213	80x2x2500	6	10	60	5	5	3.5x20	
144/3214	80x2x3000	6	10	60	5	5	3.5x20	
144/3215	80x2x3500	6	10	60	5	5	3.5x20	
144/3216	100x2x1000	6	10	60	5	5	3.5x20	
144/3217	100x2x1500	6	10	60	5	5	3.5x20	
144/3218	100x2x2000	6	10	60	5	5	3.5x20	
144/3219	100x2x2500	6	10	60	5	5	3.5x20	
144/3220	100x2x3000	6	10	60	5	5	3.5x20	
144/3221	100x2x3500	6	10	60	5	5	3.5x20	

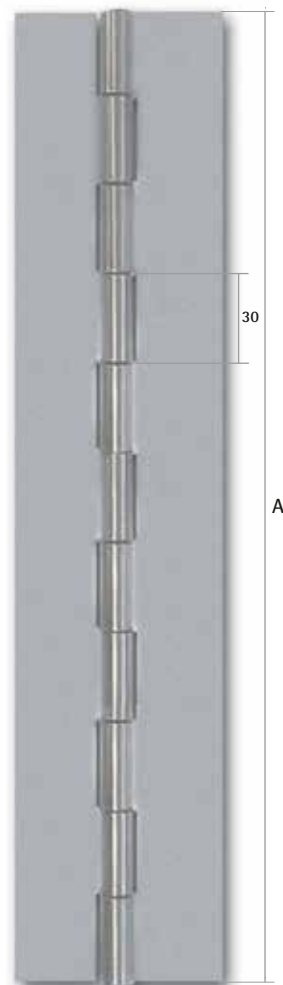
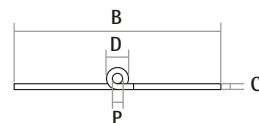

Materiales- (Acabados) / Materials- (Treatments) / Matériaux- (Finitions)

- H (PU)
- L (B)
- I304 I316 (B)

Se sirve en tiras de longitud máxima de 3,5 m. Para anchos y largos especiales, consultar.
Supplied in 3-metre maximum lengths. Consult for special widths and lengths.
Est fourni en bandes d'une longueur maximum de 3 m. Pour des largeurs et des longueurs spéciales, consulter.



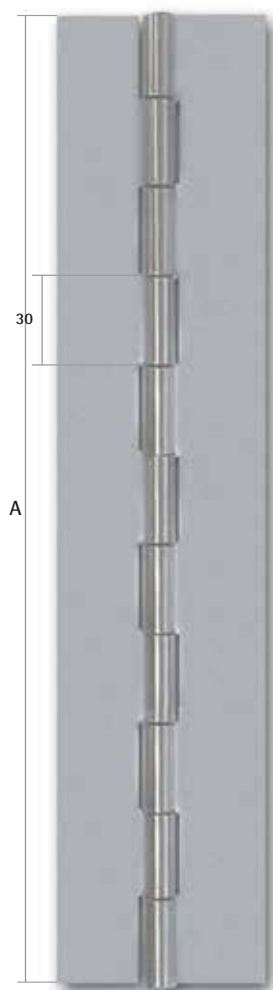
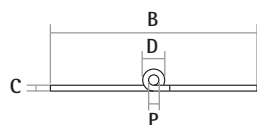

Piano (de grueso 3 mm) - *Piano (3 mm thickness)* - Piano (3 mm d'épaisseur)
 Pasador - *Pin* - Axe = Ø 6mm

Ref. 772

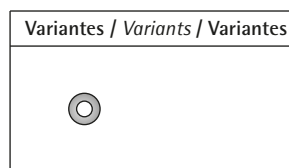

Ref./Cod.	mm Medidas Size Dimension BxCxA	P	D	E	ømm	Agujeros Holes Trou	ø Tornillo Screw Vis	
772/4789	60x3x1000	6	12	-	-	-	-	
772/4790	60x3x1500	6	12	-	-	-	-	
772/4791	60x3x2000	6	12	-	-	-	-	
772/4792	60x3x2500	6	12	-	-	-	-	
772/4793	60x3x3000	6	12	-	-	-	-	
772/4794	60x3x3500	6	12	-	-	-	-	
772/4795	80x3x1000	6	12	-	-	-	-	
772/4796	80x3x1500	6	12	-	-	-	-	
772/4797	80x3x2000	6	12	-	-	-	-	
772/4798	80x3x2500	6	12	-	-	-	-	
772/4799	80x3x3000	6	12	-	-	-	-	
772/4800	80x3x3500	6	12	-	-	-	-	
772/4801	100x3x1000	6	12	-	-	-	-	
772/4802	100x3x1500	6	12	-	-	-	-	
772/4803	100x3x2000	6	12	-	-	-	-	
772/4804	100x3x2500	6	12	-	-	-	-	
772/4805	100x3x3000	6	12	-	-	-	-	
772/4806	100x3x3500	6	12	-	-	-	-	
772/4807	120x3x1000	6	12	-	-	-	-	
772/4808	120x3x1500	6	12	-	-	-	-	
772/4809	120x3x2000	6	12	-	-	-	-	
772/4810	120x3x2500	6	12	-	-	-	-	
772/4811	120x3x3000	6	12	-	-	-	-	
772/4812	120x3x3500	6	12	-	-	-	-	



Materiales- (Acabados) / <i>Materials- (Treatments)</i> / Matériaux- (Finitions)	
 H	(PU)
 L	(B)
 I304	 I316 (B)

Se sirve en tiras de longitud máxima de 3,5 m. Para anchos y largos especiales, consultar.
Supplied in 3-metre maximum lengths. Consult for special widths and lengths.
 Est fourni en bandes d'une longueur maximum de 3 m. Pour des largeurs et des longueurs spéciales, consulter.

Piano (de grueso 3 mm) - Piano (3 mm thickness) - Piano (3 mm d'épaisseur) Pasador - Pin - Axe = Ø 10mm





Variantes / Variants / Variantes

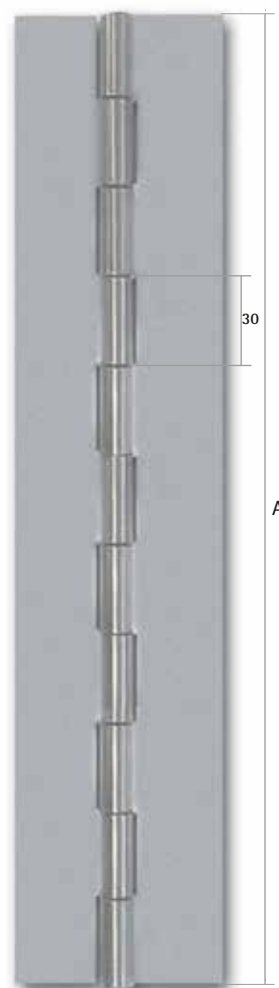
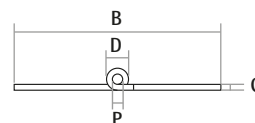

Ref./Cod.	mm Medidas Size Dimension BxCxA	P	D	E	Ømm	Agujeros Holes Trou	Ø Tornillo Screw Vis	
145/3222	80x3x1000	10	16	-	-	-	-	
145/3223	80x3x1500	10	16	-	-	-	-	
145/3224	80x3x2000	10	16	-	-	-	-	
145/3225	80x3x2500	10	16	-	-	-	-	
145/3226	80x3x3000	10	16	-	-	-	-	
145/3227	80x3x3500	10	16	-	-	-	-	
145/3228	100x3x1000	10	16	-	-	-	-	
145/3229	100x3x1500	10	16	-	-	-	-	
145/3230	100x3x2000	10	16	-	-	-	-	
145/3231	100x3x2500	10	16	-	-	-	-	
145/3232	100x3x3000	10	16	-	-	-	-	
145/3233	100x3x3500	10	16	-	-	-	-	
145/3234	120x3x1000	10	16	-	-	-	-	
145/3235	120x3x1500	10	16	-	-	-	-	
145/3236	120x3x2000	10	16	-	-	-	-	
145/3237	120x3x2500	10	16	-	-	-	-	
145/3238	120x3x3000	10	16	-	-	-	-	
145/3239	120x3x3500	10	16	-	-	-	-	
145/3240	140x3x1000	10	16	-	-	-	-	
145/3241	140x3x1500	10	16	-	-	-	-	
145/3242	140x3x2000	10	16	-	-	-	-	
145/3243	140x3x2500	10	16	-	-	-	-	
145/3244	140x3x3000	10	16	-	-	-	-	
145/3245	140x3x3500	10	16	-	-	-	-	
145/3246	180x3x1000	10	16	-	-	-	-	
145/3247	180x3x1500	10	16	-	-	-	-	
145/3248	180x3x2000	10	16	-	-	-	-	
145/3249	180x3x2500	10	16	-	-	-	-	
145/3250	180x3x3000	10	16	-	-	-	-	
145/3251	180x3x3500	10	16	-	-	-	-	



Materiales- (Acabados) / Materials- (Treatments) / Matériaux- (Finitions)

 H	(PU)
 L	(B)
 I304	 I316 (B)

Se sirve en tiras de longitud máxima de 3,5 m. Para anchos y largos especiales, consultar.

Supplied in 3-metre maximum lengths. Consult for special widths and lengths.

Est fourni en bandes d'une longueur maximum de 3 m. Pour des largeurs et des longueurs spéciales, consulter.

Bisagras tipo ramal - Strap hinges - Charnières forme oblongue

Ref.112

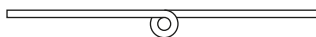

Ref./Cod.	mm Medidas Size Dimension	Agujeros x ømm Holes Trou	Ø Tornillo Screw Vis
112/080	20x60x1.2	4x3.7	3x16
112/081	20x80x1.2	4x3.7	3x16
112/082	22x100x1.5	4x5.2	4x20
112/083	22x120x1.5	4x5.2	4x20
112/084	25x140x1.5	6x5.2	4x20

Materiales- (Acabados) / Materials- (Treatments) / Matériaux- (Finitions)

H (PU) - (ZI) - (LA) - (BR)

L (PU)



Bisagras tipo ramal - Strap hinges - Charnières forme oblongue

Ref.114

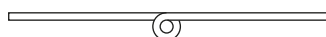

Ref./Cod.	mm Medidas Size Dimension	Agujeros x ømm Holes Trou	Ø Tornillo Screw Vis
114/1885	25x28x1	6x4.5	2.5x12
114/826	25x50x1	6x4.5	2.5x12
114/087	25x64x1	6x4.2	3x16
114/088	25x75x1	6x4.5	3x16
114/089	25x85x1	6x4.8	3.5x20
114/090	25x100x1	6x4.5	3.5x20

Materiales- (Acabados) / Materials- (Treatments) / Matériaux- (Finitions)

H (PU) - (ZI) - (LA) - (BR)

L (PU)

I304 (B)



Bisagras tipo ramal - Strap hinges - Charnières forme oblongue

Ref.117

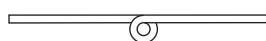

Ref./Cod.	mm Medidas Size Dimension	Agujeros x ømm Holes Trou	Ø Tornillo Screw Vis
117/096	50x80x2	6x5	4x20
117/097	50x100x2	6x5	4x20
117/098	50x120x2	6x5	4x20
117/099	50x140x2	6x5	4x20
117/100	50x180x2	4x5	4x20
117/101	50x200x2	8x5	4x20
117/2232	50x350x2	8x5.5	4.5x25
117/2233	50x400x2	8x5.5	4.5x25

Materiales- (Acabados) / Materials- (Treatments) / Matériaux- (Finitions)

H (PU) - (ZI) - (BRI)

I304 (B)

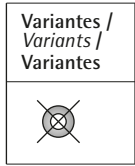

Ref.181

Bisagras tipo ramal - *Strap hinges* - Charnières forme oblongue

Ref./Cod.	mm Medidas Size Dimension	Agujeros x ømm Holes Trou	Ø Tornillo Screw Vis
181/295	22x60x1.5	6x4.5	3.5x20
181/294	22x80x1.5	6x4.5	3.5x20

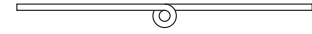

Materiales- (Acabados) / Materials- (Treatments) / Matériaux- (Finitions)

I304 (B)

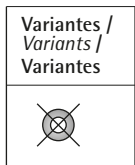

Ref.181

Bisagras tipo ramal - *Strap hinges* - Charnières forme oblongue

Ref./Cod.	mm Medidas Size Dimension	Agujeros x ømm Holes Trou	Ø Tornillo Screw Vis
181/298	20x100x2	4x6	5x25

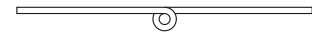

Materiales- (Acabados) / Materials- (Treatments) / Matériaux- (Finitions)

I304 (B)

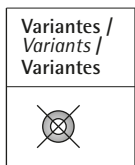

Ref.181

Bisagras tipo ramal - *Strap hinges* - Charnières forme oblongue

Ref./Cod.	mm Medidas Size Dimension	Agujeros x ømm Holes Trou	Ø Tornillo Screw Vis
181/301	43x100x2	6x5	4x20

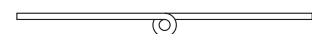

Materiales- (Acabados) / Materials- (Treatments) / Matériaux- (Finitions)

I304 (B)



Bisagras tipo ramal - *Strap hinges* - Charnières forme oblongue

Ref.181



Ref./Cod.	mm Medidas Size Dimension	Agujeros x ømm Holes Trou	Ø Tornillo Screw Vis	
181/296	25x40x2	-	-	
181/297	25x60x2	-	-	

Variantes /
Variants /
Variantes



Materiales- (Acabados) / Materials- (Treatments) / Matériaux- (Finitions)

I304 (B)



Bisagras tipo ramal - *Strap hinges* - Charnières forme oblongue

Ref.181



Ref./Cod.	mm Medidas Size Dimension	Agujeros x ømm Holes Trou	Ø Tornillo Screw Vis	
181/299	30x100x3	-	-	
181/300	30x200x3	-	-	

Variantes /
Variants /
Variantes



Materiales- (Acabados) / Materials- (Treatments) / Matériaux- (Finitions)

I304 (B)



Bisagras tipo ramal con arandelas - *Strap hinges* - Charnières forme oblongue

Ref.181

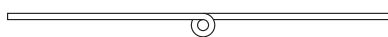

Ref./Cod.	mm Medidas Size Dimension	Agujeros x ømm Holes Trou	Ø Tornillo Screw Vis	
181/672	100x120x3	-	-	
181/671	100x140x3	-	-	
181/302	100x220x3	-	-	
181/673	100x240x3	-	-	

Variantes /
Variants /
Variantes



Materiales- (Acabados) / Materials- (Treatments) / Matériaux- (Finitions)

I304 (B) - (SA)



Ref.115

Bisagras tipo ramal doble hoja - *Strap hinges* - Charnières forme oblongue

Ref./Cod.	mm Medidas Size Dimension	Agujeros x ømm Holes Trou	Ø Tornillo Screw Vis
115/091	20x90x2.6	4x5	4x20
115/092	20x140x3.4	4x5	4x20
115/093	20x200x5	6x6.5	5x25
115/094	20x300x5	6x6.5	5x25



Materiales- (Acabados) / Materials- (Treatments) / Matériaux- (Finitions)

H (PU) - (LA) - (ZI) - (BRI)



24 u.

Ref.78

Bisagras tipo ramal doble hoja - *Strap hinges* - Charnières forme oblongue

Ref./Cod.	mm Medidas Size Dimension	Agujeros x ømm Holes Trou	Ø Tornillo Screw Vis
78/2227	30x100x3	8x4.5	3.5x20
78/2228	30x150x3	6x5.5	4.5x25
78/2229	30x200x3	6x5.5	4.5x25
78/2230	30x250x3	6x5.5	4.5x25
78/2231	35x300x3	6x5.5	4.5x25



Materiales- (Acabados) / Materials- (Treatments) / Matériaux- (Finitions)

H (PU) - (ZI)



25 u.

Ref.456

Bisagras ramal especiales - *Especial strap hinges* - Charnières spéciaux

Ref./Cod.	mm Medidas Size Dimension	Agujeros x ømm Holes Trou	Ø Tornillo Screw Vis
456/1353	56x150x3	4x8.5	-
456/1983	58x150x4	4x8.5	-



Materiales- (Acabados) / Materials- (Treatments) / Matériaux- (Finitions)

I304 (B)



10 u.

Bisagras tipo ramal - *Tabletop hinges* - Charnières forme oblongue

Ref.116



Ref./Cod.	mm Medidas Size Dimension	Agujeros x ømm Holes Trou	Ø Tornillo Screw Vis
116/095	32x80x1.5	6x5	3.5x20

Materiales- (Acabados) / Materials- (Treatments) / Matériaux- (Finitions)

H (PU) - (ZI) - (LA) - (BR) - (NI)

L (PU)



Bisagras para mesa - *Tabletop hinges* - Charnières pour table

Ref.113

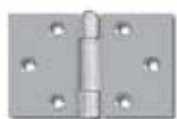

113/1886

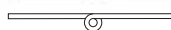

Ref./Cod.	mm Medidas Size Dimension	Agujeros x ømm Holes Trou	Ø Tornillo Screw Vis
113/1886	40x60x1.5	6x5	3.5x20
113/085	45x80x1.5	6x5	3.5x20
113/086	50x85x1.5	6x5	3.5x20

Variantes /
Variants /
Variantes



113/085
113/086



Materiales- (Acabados) / Materials- (Treatments) / Matériaux- (Finitions)

H (PU) - (ZI) - (LA) - (BR)

L (PU)

I304 (B)



Bisagras para mesa retenidas 180° - *Tabletop hinges* - Charnières pour table

Ref.132

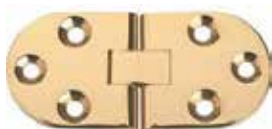

Ref./Cod.	mm Medidas Size Dimension	Agujeros x ømm Holes Trou	Ø Tornillo Screw Vis
132/170	30x80x1.5	6x5	3.5x20

Materiales- (Acabados) / Materials- (Treatments) / Matériaux- (Finitions)

L (PUE) - (CR)



Bisagras para mesa retenidas 180° - *Tabletop hinges* - Charnières pour table

Ref.537



Ref./Cod.	mm Medidas Size Dimension	Agujeros x ømm Holes Trou	Ø Tornillo Screw Vis
537/2730	44x153x5		

Materiales- (Acabados) / Materials- (Treatments) / Matériaux- (Finitions)

H (BRI)



BISAGRAS INVISIBLES

CONCEALED HINGES

CHARNIÈRES INVISIBLES



Bisagras cazoleta para muebles 26 mm - 26 mm *Concealed cup hinges slide-on* - Charnières à boîtier 26 mm

Ref.161



Ref./Cod.	Denominación Name Dénomination
161/264	Plana/ <i>Full overlay</i> / En applique
161/265	Codo/ <i>Half overlay</i> / Montant central
161/266	S. codo/ <i>Inset overlay</i> / Fentrant

Bisagra con base H=2
C.C.= 48 mm

Materiales- (Acabados) / *Materials- (Treatments)* / *Matériaux- (Finitions)*

H (NI)



Bisagras cazoleta para muebles 35 mm - 35 mm *Concealed cup hinges slide-on* - Charnières à boîtier 35 mm

Ref.162



Ref./Cod.	Denominación Name Dénomination
162/267	Plana/ <i>Full overlay</i> / En applique
162/268	Codo/ <i>Half overlay</i> / Montant central
162/269	S. codo/ <i>Inset</i> / Fentrant

Bisagra con base H=2
C.C.= 48 mm

Materiales- (Acabados) / *Materials- (Treatments)* / *Matériaux- (Finitions)*

H (NI)



Bisagras cazoleta para muebles 35 mm con clip - 35 mm *Concealed cup hinges clip-on* - Charnières à boîtier 35 mm

Ref.163



Ref./Cod.	Denominación Name Dénomination
163/270	Plana/ <i>Full overlay</i> / En applique
163/271	Codo/ <i>Half overlay</i> / Montant central
163/272	S. codo/ <i>Inset</i> / Rentrant

Bisagra con base H=2
C.C.= 48 mm

Materiales- (Acabados) / *Materials- (Treatments)* / *Matériaux- (Finitions)*

H (NI)



Bisagras invisibles (montaje sobrepuesto) - *Easy-on concealed hinges* - Charnière à visser à ressort

Ref.167



Ref./Cod.	mm Medidas Size Dimension
167/281	44x104x1,2

Materiales- (Acabados) /
Materials- (Treatments) /
Matériaux- (Finitions)

H (ZI)

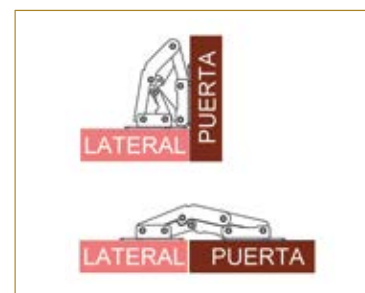

Bisagra cazoleta de 35mm amortiguada a con montaje rápido por clip - Concealed hinges with soft-closing clip-on - Charnières à boîtier



Ref./Cod.	Denominación Name Dénomination	
711-P	Plana/ Full overlay/ En applique	CC=48mm
711-C	Codo/ Half overlay/ Montant central	CC=48mm
711-S	S. codo/ Inset/ Rentrant	CC=48mm

Materiales / Materials / Matériaux

H (NI)

Se sirven sin base, siendo compatibles con la ref. 715
Posibilidad de pedir las bisagras con tacos 10x10.

Supplied without base, being compatible with ref. 715
Also available: hinges with 10x10 dowels.

Livrée sans base, restant compatible avec ref. 715
Aussi disponible: charnières avec chevilles 10x10.



Bases bisagra cazoleta con clip - Clip fitting bases - Embases pour charnière à clipser

Ref./Cod.	Denominación Name Dénomination
715-H0	Base Altura 0mm para cazoleta con clip
715-H2	Base Altura 2mm para cazoleta con clip
716-H0	Base Regulable altura 0mm para cazoleta con clip
716-H2	Base Regulable altura 2mm para cazoleta con clip



Materiales / Materials / Matériaux

H (NI)

Bases sueltas compatibles con la bisagra ref. 711.
Posibilidad de pedir las bases con tacos 5x10.

Loose bases compatibles with hinges ref. 711.
Also available: bases with 5x10 dowels.

Bases en vrac, compatibles avec la charnière ref. 711.
Aussi disponible: bases avec chevilles 5x10.



Distintos montajes con bisagra de cazoleta Different applications: Overlay or inset Types de ferrage: les 3 coudures



PLANA
FULL OVERLAY
EN APPLIQUE

La puerta queda por delante de la estructura del mueble, tapando por completo el lateral

Door stays ahead of the furniture structure, completely covering the side structure.

La porte reste par-devant de la structure du meuble, en couvrant complètement le latéral



CODO
HALF OVERLAY
DE MONTANT CENTRAL

La puerta queda por delante de la estructura del mueble, tapando la mitad del canto lateral

Door stays ahead of furniture structure, only covering the half of the side structure.

La porte reste par-devant de la structure, en couvrant la moitié ou latéral

La puerta queda por dentro de la estructura del mueble, quedando el canto lateral a la vista.

Door stays within the furniture structure, staying the side structure at sight.

La porte reste en dedans de la structure du meuble, en restant à vue le latéral.



SUPERCODO
INSET
RENTRANT

Bisagras cilíndricas tipo barril - *Concealed barrel hinges* - *Cylindrique pour meubles*

Ref.458

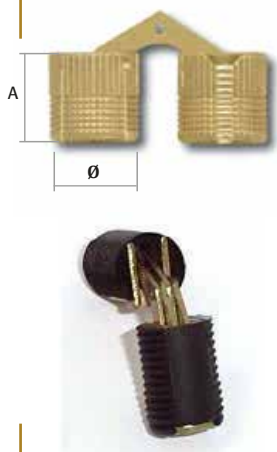

Ref./Cod.	mm Medidas Size Dimension	A	Max. apertura Max. opening Ouverture max.	Material (Acabado) Material (Treatment) Matériaux (Finition)	
458/1754	ø8x19	9.5	180°	L (PU)	48
458/273	ø10x22	11	180°	L (PU)	48
458/274	ø12x27	13.5	180°	L (PU)	48
458/275	ø14x31	15.5	180°	L (PU)	24
458/276	ø16x33	16.5	180°	L (PU)	24
458/277	ø18x35	17.5	180°	L (PU)	24
458/4819	ø12		180°	PLAS + H (GR)-(MR)	24
458/4630	ø14		180°	PLAS + H (GR)-(MR)	24

Bisagras invisibles ovaladas - *Concealed hinges* - *Ovale pour meubles*

Ref.165



Ref./Cod.	mm Medidas Size Dimension	E	Max. apertura Max. opening Ouverture max.
165/278	90x45	29	180°

Materiales- (Acabados) / Materials- (Treatments) / Matériaux- (Finitions)

I304 (SA)



Bisagras invisibles ovaladas - *Concealed hinges* - *Ovale pour meubles*

Ref.166



Ref./Cod.	mm Medidas Size Dimension	E	Max. apertura Max. opening Ouverture max.
166/340	40x36x2	13	180°
166/279	65x36x2	13	180°

Materiales- (Acabados) / Materials- (Treatments) / Matériaux- (Finitions)

H (LA) - (BRI)



Bisagras invisibles ovaladas - *Concealed hinges* - *Ovale pour meubles*

Ref.496



Ref./Cod.	mm Medidas Size Dimension	E	Max. apertura Max. opening Ouverture max.
496/2294	45x34	14	180°
496/2295	70x43	16	180°
496/2296	96x50	19	180°

Materiales- (Acabados) / Materials- (Treatments) / Matériaux- (Finitions)

Z (NIS) + I304



BISAGRAS CON MUELLE
SPRING HINGES
CHARNIÈRES À RESSORTS



Bisagras con muelle - Spring hinges - Charnières à ressort

Ref.175

Ref./Cod.	mm Medidas Size Dimension	Agujeros x ømm Holes Trou	Ø Tornillo Screw Vis
175/1365	50x30x1.2	6x4.5	4x25
175/1364	60x45x1.5	6x4.5	4x25
175/1196	50x50x2	4x5.2	4.5x25

Variantes / Variants / Variantes



Materiales- (Acabados) / Materials- (Treatments) / Matériaux- (Finitions)

H (Zl)

I304 (B)



Ref. 175/1365



Ref. 175/1364



Ref. 175/1196



Bisagras con muelle - Spring hinges - Charnières à ressort

Ref.175

Ref./Cod.	mm Medidas Size Dimension	Agujeros x ømm Holes Trou	Ø Tornillo Screw Vis
175/1195	60x50x2	6x5	4x25
175/1217	60x57x1.5	4x5	3.5x25
175/611	60x1.5 (Máx. = 147°)	4x5	4x25

Variantes / Variants / Variantes

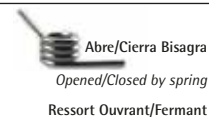

Materiales- (Acabados) / Materials- (Treatments) / Matériaux- (Finitions)

H (Zl)

I304 (B)



Ref. 175/1195



Ref. 175/1217



Ref. 175/611





Variantes / Variants / Variantes



Abre/Cierra Bisagra
Opened/Closed by spring
Ressort Ouvrant/Fermant

Ref./Cod.	mm Medidas Size Dimension	Agujeros x ømm Holes Trou	Ø Tornillo Screw Vis
141/1060	150x56x1.2	4x3	3x16
142/1032	90x25x1.2	4x3	3x16
142/2692	150x25x1.2	6x3	3x16
360/1219	68x26x0.8	-	-

Materiales- (Acabados) / Materials- (Treatments) / Matériaux- (Finitions)

 H	(Z1)
 1304	(B)



Ref. 141/1060



Ref. 142/1032



Ref. 360/1219



Elija opción del muelle: abrir / cerrar bisagra
Spring options: loaded to open / loaded to close
Options de ressort: ouvrant / fermant



MUELLE ABRE BISAGRA
HINGE OPENED BY SPRING
AVEC RESSORT OUVRANT



MUELLE CIERRA BISAGRA
HINGE CLOSED BY SPRING
AVEC RESSORT FERMANT



Con nuestras bisagras de muelle interno, usted elige la función de Abre / Cierra según su necesidad.

On behalf of the internal spring hinges, customer will decide spring's function (open/close) when installing.

En ce qui concerne les charnières à ressort interne, c'est à vous de l'installer en ouvrant ou fermant

Ref./Cod.	mm Medidas Size Dimension	Agujeros x ømm Holes Trou	Ø Tornillo Screw Vis
382/1275	90x50x2	4x6	4.5x25
575/2930	100x68x2.5	6x7	4.5x25
356/1348	95x60x3	8x7	5x25

Variantes / Variants / Variantes

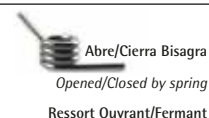

Materiales- (Acabados) / Materials- (Treatments) / Matériaux- (Finitions)

- H (ZI)
- I304 (PUE)



Ref. 382/1275



Ref. 575/2930

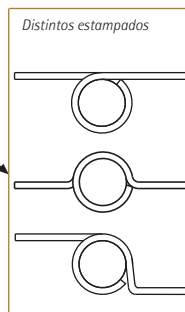

Ref. 356/1348



Ref./Cod.	mm Medidas Size Dimension	Agujeros x ømm Holes Trou	Ø Tornillo Screw Vis
382/1273	90x48x2	4x6	4.5x25
356/1347	95x83x3 Pala 37 mm	4x7	4.5x25
356/4277	95x90x3 Pala 46 mm	4x7	4.5x25

Variantes / Variants / Variantes



Materiales- (Acabados) / Materials- (Treatments) / Matériaux- (Finitions)

- I304 (PUE)



Ref. 382/1273



Ref. 356/1347 Ref. 356/4277



Ref. 356/1231



Accesorios
Pag. 132

BISAGRAS TAQUILLA Y ARMARIO METÁLICO

HINGES FOR LOCKERS

CHARNIÈRES POUR CASIERS





Ref./Cod.	mm Medidas Size Dimension	Agujeros x ømm Holes Trou	Ø Tornillo Screw Vis
377/751	60x1.5	4x6	5x25
377/899	70x55x1,2	6x4,2	3,5x20
377/1054	60x40+25x2	6x10	M5
377/1335	60x66x2	8x10	M6
377/1138	60x57x2	2x7	6x30
		5,5x10	-
377/1241	60x58x2	2x7	6x30
		5,5x10	-

Materiales- (Acabados) / Materials- (Treatments) / Matériaux- (Finitions)

I304 (B)

I316 (B)



Ref. 377/751



Ref. 377/899



Ref. 377/1054



Ref. 377/1335



Ref. 377/1138



Ref. 377/1241





Ref./Cod.	mm Medidas Size Dimension	Agujeros x ømm Holes Trou	Ø Tornillo Screw Vis
447/1827	62x62x2	4x6x15	-
447/1828	62x62x2	4x7	2 M5
447/1829	62x62x2,5	2x9,5	2 M5
		4x10x6	-
198/307	70x50x2	4x5	4,5x25

Materiales- (Acabados) / Materials- (Treatments) / Matériaux- (Finitions)

I304 (B)

I316 (B)



Ref. 447/1827



Ref. 447/1828



Ref. 447/1829



Ref. 198/307

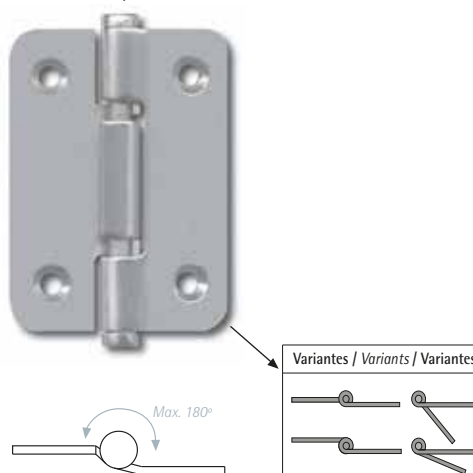

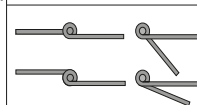

Variantes / Variants / Variantes



Bisagras para armarios metálicos - Hinges for metallic closets - Charnières pour armoires métalliques

Ref.447

Ref./Cod.	mm Medidas Size Dimension	Agujeros x ømm Holes Trou	Ø Tornillo Screw Vis
447/1830	40x45x2	1x5	4,5x25
447/1831	60x33x2	2xM4	-
447/1832	80x2	2x5	4,5x25
447/1850	80x3	 2x(5x8)	M5
447/1833	48x1,5	1x7	6x12
447/1834	50x1,5	2x5	4,5x25
447/2222	90x3	 2x(6,3x9)	M5
		2x6,8	4,5x25

Materiales- (Acabados) / Materials- (Treatments) / Matériaux- (Finitions)

I304 (B)

I316 (B)



Ref. 447/1830



Ref. 447/1831

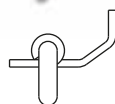

Ref. 447/1832
Ref. 447/1850

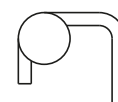

Ref. 447/1833



Ref. 447/1834



Ref. 447/2222

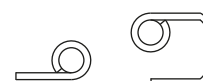

BISAGRAS GAMA NAÚTICA

NAUTICAL RANGE HINGES

CHARNIÈRES GAMME NAUTIQUE

"INOX.316"



Bisagras gama náutica - Nautical range hinges - Charnières gamme nautique

Ref.188

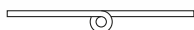

Ref./Cod.	mm Medidas Size Dimension	Agujeros x ømm Holes Trou	Ø Tornillo Screw Vis
188/310	40x40x1	4x5	4x20
188/307	40x40x2	4x5	4x20
188/308	50x50x2	4x5	4x20

Variantes / Variants / Variantes



Materiales- (Acabados) / Materials- (Treatments) / Matériaux- (Finitions)

I304 (B)

I316 (B)



Bisagras gama náutica - Nautical range hinges - Charnières gamme nautique

Ref.193

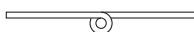

Ref./Cod.	mm Medidas Size Dimension	Agujeros x ømm Holes Trou	Ø Tornillo Screw Vis
193/311	50x50x1.2	6x5	4x20

Variantes / Variants / Variantes



Materiales- (Acabados) / Materials- (Treatments) / Matériaux- (Finitions)

I304 (B)

I316 (B)



Bisagras gama náutica - Nautical range hinges - Charnières gamme nautique

Ref.193

Ref./Cod.	mm Medidas Size Dimension	Agujeros x ømm Holes Trou	Ø Tornillo Screw Vis
193/313	50x50x2	2x5 ○ 2x(5x8)	3.5x20
193/314	50x50x2	2x5 ○ 2x(5x8)	3.5x20

Variantes / Variants / Variantes



Materiales- (Acabados) / Materials- (Treatments) / Matériaux- (Finitions)

I304 (B)

I316 (B)



Ref. 193/313

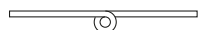

Ref. 193/314

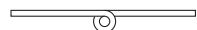

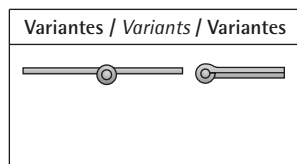

Ref./Cod.	mm Medidas Size Dimension	Agujeros x ømm Holes Trou	Ø Tornillo Screw Vis
188/306	40x60x2	5x5	4x20
188/1175	50x80x2	5x5	4x20
193/312	40x70x2	6x5	4x20

Materiales- (Acabados) / Materials- (Treatments) / Matériaux- (Finitions)

I304 (B)

I316 (B)



Ref. 188/306

Ref. 188/1175

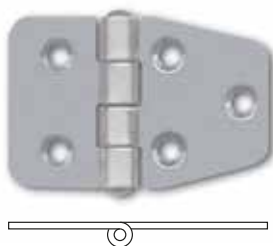

Ref. 193/312

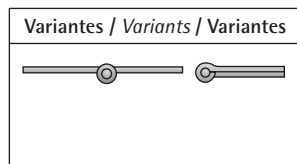
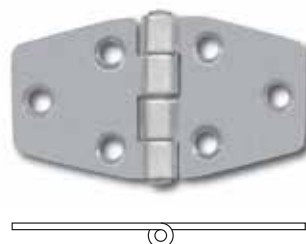

Ref./Cod.	mm Medidas Size Dimension	Agujeros x ømm Holes Trou	Ø Tornillo Screw Vis
188/309	32x80x1.5	6x5	4x20
188/837	40x106x2	5x5.5	4x20
188/1451	40x127x2	5x5.5	4x20

Materiales- (Acabados) / Materials- (Treatments) / Matériaux- (Finitions)

I304 (B)

I316 (B)



Ref. 188/309

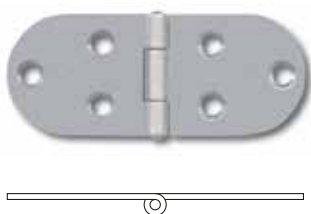

Ref. 188/837



Ref. 188/1451

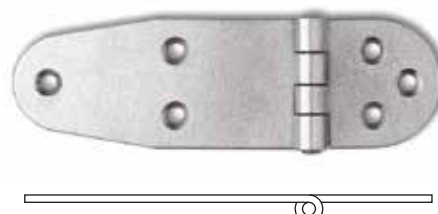

Bisagras gama náutica - Nautical range hinges - Charnières gamme nautique

Ref.193



Ref./Cod.	mm Medidas Size Dimension	Agujeros x ømm Holes Trou	Ø Tornillo Screw Vis
193/768	100x84x3	8x5.5	4.5x25

Materiales- (Acabados) / Materials- (Treatments) / Matériaux- (Finitions)

I304 (B)

I316 (B)



Bisagras gama náutica - Nautical range hinges - Charnières gamme nautique

Ref.193



Ref./Cod.	mm Medidas Size Dimension	Agujeros x ømm Holes Trou	Ø Tornillo Screw Vis
193/568	80x92x3	4x3	-

Materiales- (Acabados) / Materials- (Treatments) / Matériaux- (Finitions)

I304 (B)

I316 (B)



Bisagras gama náutica - Nautical range hinges - Charnières gamme nautique

Ref.336



Ref./Cod.	mm Medidas Size Dimension	Agujeros x ømm Holes Trou	Ø Tornillo Screw Vis
336/4676	65x186x4	6x6	5x25

Materiales- (Acabados) / Materials- (Treatments) / Matériaux- (Finitions)

I304 (B)

I316 (B)



ACEROS INOXIDABLES (I304) y (I316)

Los aceros inoxidable son una aleación compuesta principalmente de Hierro, Carbono, y un mínimo del 10,5% de Cromo. Poseen una elevada resistencia a la corrosión (óxido), por la capa pasivadora que se forma al reaccionar el Cromo con el Oxígeno. Hay diferentes tipos de Acero Inoxidable, dependiendo de su composición, por lo que frente a ciertas condiciones no experimentarán el mismo grado de corrosión. La resistencia varía según el tipo de ácido, temperatura, pH, y tiempo de exposición. Debe limpiarse correcta y periódicamente, para que no se pierda la capa pasiva, lo que convertiría la superficie en "activa", permitiendo la corrosión.

-Acero Inoxidable (AISI304) : Acero inoxidable austenítico, aleado con Cromo y Níquel y bajo contenido en Carbono. Presenta una buena resistencia a la corrosión. No es templable ni magnético y puede ser trabajado fácilmente en frío. Se utiliza en diferentes piezas mecánicas, utensilios domésticos, elementos ornamentales, elementos estructurales y construcción, y en las industrias; alimenticia, vitivinícola, frutícola, acuícola, minera, etc.

-Acero Inoxidable (AISI316) : Acero inoxidable austenítico, aleado al Cromo-Níquel-Molibdeno. La adición de Molibdeno hace que su resistencia a la corrosión sea mayor que en el AISI304, lo que permite emplearlo en medios más agresivos. No es templable ni magnético y puede ser trabajado fácilmente en frío. Su aplicación es frecuente en la construcción y las industrias; naval, alimenticia, química, farmacéutica, petroquímica, papelera y minera.

STAINLESS STEEL (I304) y (I316)

Stainless Steel is an alloy which mainly consists of steel, carbon and a minimum of 10.5% chromium. Because of a passive film that is formed when the chrome reacts with the oxygen, Stainless steel has high corrosion (rust) resistance. It is non-toughenable and non-magnetic, and it can be easily cold-worked. There are different grades of Stainless Steel to suit the environment the alloy must endure. So under certain conditions, the different types won't experience same level of corrosion. Resistance will differ depending on acid type, temperature, pH and exposure time. Stainless Steel must be properly and regularly cleaned, so that the passive film does not get lost, which would turn the surface into "active", allowing corrosion.

-Stainless Steel (AISI304): Austenite steel, alloyed with chromium and nickel, with low carbon content. AISI304 is used for a wide variety of machinery parts, domestic utensils, ornamental elements, structural elements and construction, and within various industries such as food, wine, fruit and mining industries.

-Stainless Steel (AISI316): Austenite steel, alloyed with chromium-nickel-molybdenum. The addition of molybdenum gives higher corrosion resistance than with AISI304. AISI316 is used within construction and various industries such as naval, food, chemical, pharmaceutical, petrochemical, paper and miner industries.

ACIER INOXYDABLE (I304) y (I316)

L'Acier Inoxydable est un alliage d'acier, carbone et au moins 10,5 % de chrome. Grâce à une couche passive (protectrice) qui se forme quand le chrome réagit avec le dioxygène de l'air, l'Acier Inoxydable est caractérisé par une haute résistance à la corrosion. N'est pas trempable, n'est pas magnétique, et on peut le travailler facilement à froid. En fonction de sa composition, on distingue différents types d'aciers inoxydables. En face de certaines conditions, ils n'expérimenteront pas le même degré de corrosion. La résistance varie selon le type d'acide, la température, le pH, et le temps d'exposition. Il est extrêmement important de nettoyer l'Acier Inoxydable convenablement et périodiquement, de façon que la couche passive ne se perde pas, car ça changerait la surface dans "active", en permettant la corrosion du matériau.

-Acier Inoxydable (AISI304): Acier austénitique, alliage au chrome et nickel, avec une très faible teneur en carbone. AISI304 est utilisé dans différentes pièces mécaniques, des ustensiles domestiques, des éléments ornementaux, des éléments structurels, dans la construction, et dans l'industrie, l'alimentaire, vinicole, minière, etc.

-Acier Inoxydable (AISI316): Acier austénitique, alliage au chrome-nickel-molybdène. L'ajout de molybdène fait que la résistance à la corrosion est encore plus qu'avec l'AISI304. AISI316 est utilisé dans la construction et dans l'industrie, la navale, alimentaire, chimique, pharmaceutique, papetière, minière, etc

Bisagras para perfil - Hinges for profile - Charnière pour profil

Ref.201-202

Ref./Cod.	mm Medidas Size Dimension	Agujeros x ømm Holes Trou	Ø Tornillo Screw Vis
201/310	100x20x2	8x4.5 2x9.5	3x16
202/311	50x68x20x2	2x13.5 5x5	3x16

Materiales- (Acabados) / Materials- (Treatments) / Matériaux- (Finitions)

I304 (B)



Ref. 201



Ref. 202



Bisagras para cercos metálicos - Hinges for profile - Charnière pour profil

Ref.356-457

Ref./Cod.	mm Medidas Size Dimension	Agujeros x ømm Holes Trou	Ø Tornillo Screw Vis
356/1153	95x83x3 - Pala 37 mm	4x6	4.5x25
356/1940	95x90x3 - Pala 46 mm	4x6	4.5x25
457/1687	95x3	2x11	M10

Materiales- (Acabados) / Materials- (Treatments) / Matériaux- (Finitions)

I304 (B) - (SA)



Ref.356



Ref.457



Ref. 356/1231



Accesorios
Pag. 132

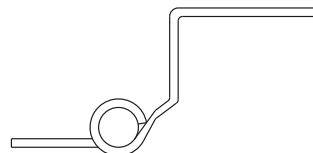
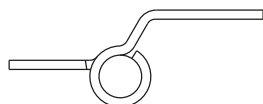

Ref.199

Bisagra maleta - *Open limited hinges for suitcase* - Charnières pour valise

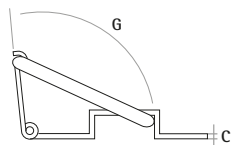

Ref./Cod.	mm Medidas Size/Dimension AxBxC	G	Agujeros x ømm Holes Trou	Ø Tornillo Screw Vis
199/308	43x75x1.2	95°	5x4.2	3x16

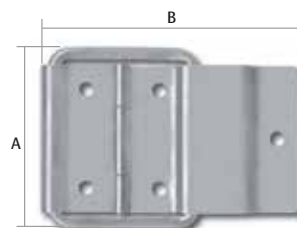

Materiales- (Acabados) / Materials- (Treatments) / Matériaux- (Finitions)

H (CR)

Ref.204

Bisagra triple - *Triple hinge* - Triple charnière



Ref./Cod.	mm Medidas Size Dimension	Agujeros x ømm Holes Trou	Ø Tornillo Screw Vis
204/313	85x48x2	4x5	4x20



Materiales- (Acabados) / Materials- (Treatments) / Matériaux- (Finitions)

I304 (B)

Ref.526

Bisagras solapadas - *Overlay door angle hinges* - Charnières double équerre



Ref./Cod.	mm Medidas Size Dimension	Agujeros x ømm Holes Trou	Ø Tornillo Screw Vis
526/2557	40x76x2	-	-



Materiales- (Acabados) / Materials- (Treatments) / Matériaux- (Finitions)

I304 (B)

Conjunto bisagra pivotante- *Inset door pivot hinges kit* - Charnière pivot

Ref.212



Ref./Cod.	mm Medidas Size Dimension	Agujeros x ϕ mm Holes Trou	ϕ Tornillo Screw Vis 
212/4822	70x15x3	4x7	4,5x25

Materiales- (Acabados) / Materials- (Treatments) / Matériaux- (Finitions)

- H (LA)
- L (PU)
- I304 (B)



Centrador - *Centering* - Centrage

Ref.203



Ref./Cod.	mm Medidas Size Dimension
203/2663	57x12x2

Materiales- (Acabados) / Materials- (Treatments) / Matériaux- (Finitions)

- H (LA)
- L (PU)
- I304 (B)



Conjunto bisagra ventana giratoria - *Turning window hinge* - Charnière fenêtre rotative

Ref.203



Ref./Cod.	mm Medidas Size Dimension
203/312	60x16x2

Materiales- (Acabados) / Materials- (Treatments) / Matériaux- (Finitions)

- H (LA)
- L (PU)



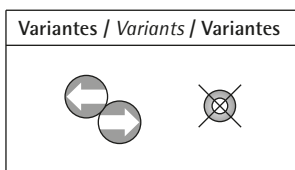

Ref./Cod.	mm Medidas Size/Dimension A x B x C	Agujeros x ømm Holes Trou	Ø Tornillo Screw Vis
446/4007	50x22x1,2	-	-
446/1797	60x18x2,6	-	-
446/4722	70x25x1,5	-	-

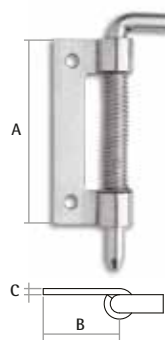

Materiales- (Acabados) / Materials- (Treatments) / Matériaux- (Finitions)

H	(NI)
I304	(B)

Ref./Cod.	mm Medidas Size Dimension	Material (Acabado) Material (Treatment) Matériaux (Finition)
534/4272	40x15x12	H (PING)
534/2698	50x22x12	I304 (B)



Características/ Characteristics / Caractéristiques

Conjunto de bisagras para vitrina con cristal de espesor máx. 7mm
 Hinge set for glass (maximum thickness of 7mm)
 Charnières kit pour verre (7mm d'épaisseur max.)

PERNIOS PUERTA MADERA / *LIFT-OFF HINGES FOR DOORS* / PAUMELLES POUR PORTE PAG. 84-87

PERNIOS PARA SOLDAR / *WELDING LIFT-OFF HINGES* / PAUMELLES À SOUDER PAG. 87-88

PERNIOS ESPECIALES / *SPECIAL LIFT-OFF HINGES* / PAUMELLES SPÉCIAUX PAG. 89-91



Pernios quita y pon - *Lift off hinges* - Paumelles démontables

Ref.137-Mod.403



Ref./Cod.	mm Medidas Size Dimension	Agujeros x ømm Holes Trou	ø Tornillo Screw Vis
137/188	95x55x2	6x5	4x25
137/1015	100x57x2	6x5	4x25
137/189	110x55x2	6x5	4x25
137/869	140x55x2.5	8x5.5	4.5x25
137/880	140x70x3	8x5.5	4.5x25
137/2384	110x55x2.5	6x5	4x25

Materiales- (Acabados) / Materials- (Treatments) / Matériaux- (Finitions)

I304 (SA)

I316 (SA)

Variantes / Variants / Variantes

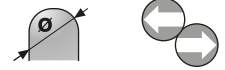

Pernios quita y pon - *Lift off hinges* - Paumelles démontables

Ref.138-Mod.409



Ref./Cod.	mm Medidas Size Dimension	Agujeros x ømm Holes Trou	ø Tornillo Screw Vis
138/1012	90x65x2.5	6x6	4.5x25
138/190	100x86x3	8x6	5x25

Materiales- (Acabados) / Materials- (Treatments) / Matériaux- (Finitions)

I304 (SA)

I316 (SA)

Variantes / Variants / Variantes

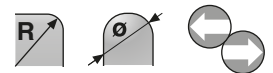

Pernios quita y pon - *Lift off hinges* - Paumelles démontables

Ref.139-Mod.408

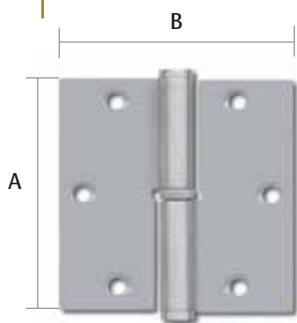

Ref./Cod.	mm Medidas /AxBxC Size Dimension	d ø int.	D ø ext.	Agujeros x ømm Holes Trou	ø Tornillo Screw Vis
139/2319	75x75x2.5	7	13	6x6	4.5x25
139/191	80x82x2.5	7	13	6x6	4.5x25
139/192	90x65x2.5	7	13	6x6	4.5x25
139/193	100x82x2.5	7	13	6x6	4.5x25
139/194	100x100x3	10	16	8x5.5	4.5x25
139/840	120x86x3	8	14	8x6	4.5x25

Materiales- (Acabados) / Materials- (Treatments) / Matériaux- (Finitions)

I304 (SA)

I316 (SA)

Variantes / Variants / Variantes



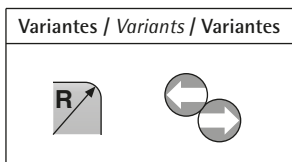

Ref./Cod.	mm Medidas Size Dimension	Agujeros x ømm Holes Trou	Ø Tornillo Screw Vis
120/114	50x40x1.5	6x4	3.5x20
120/115	50x45x1.5	6x4	3.5x20
120/116	60x40x1.5	6x4.5	4x20
120/117	70x50x2	6x4.5	4x20
120/118	80x50x2	6x4.5	4x20
120/119	80x60x2	6x4.5	4x20

Materiales- (Acabados) / Materials- (Treatments) / Matériaux- (Finitions)

H	(LA) - (NI)
L	(PU)
I304	(SA)

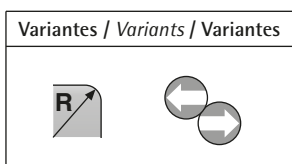
Pernio de seguridad - *Lift off security hinges* - Paumelles sécurité

Ref./Cod.	mm Medidas Size Dimension	Agujeros x ømm Holes Trou	Ø Tornillo Screw Vis
158/257	80x82x2.5	6x6	4.5x25
158/258	100x82x2.5	6x6	4.5x25

Materiales- (Acabados) / Materials- (Treatments) / Matériaux- (Finitions)

I304	(B) - (SA)
-------------	------------

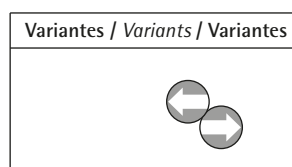
Pernio de seguridad antipinzamiento - *Safety lift off hinges* - Paumelles sécurité anti-trap

Ref./Cod.	mm Medidas Size Dimension	Agujeros x ømm Holes Trou	Ø Tornillo Screw Vis
138/1839	90x45+40x2.5	6x5	4x20
138/2276	90x64.5+35.5x2.5	6x5	4x20
138/2350	100x56+33x2	6x5	4x20
138/2351	100x86+47x3	6x5	4x20

Materiales- (Acabados) / Materials- (Treatments) / Matériaux- (Finitions)

I304	(SA)
-------------	------



Pernios pala - Flag lift-off hinges - Paumelles

Ref.377



Ref./Cod.	mm Medidas Size Dimension	Agujeros x ømm Holes Trou	Ø Tornillo Screw Vis
377/1849	98x85x2.5	8x6	4.5x25

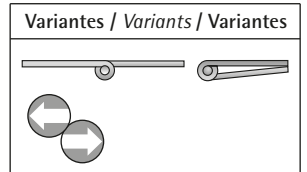

Materiales- (Acabados) / Materials- (Treatments) / Matériaux- (Finitions)

1304 (SA)



Pernios especiales - Special lift-off hinges - Paumelles spéciaux

Ref.154



Ref./Cod.	mm Medidas Size Dimension	Agujeros x ømm Holes Trou	Ø Tornillo Screw Vis
154/252	138x82x2.5	6x5.7	4.5x25

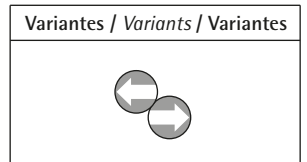

Materiales- (Acabados) / Materials- (Treatments) / Matériaux- (Finitions)

H (PU) - (ZI)

1304 (SA)



Pernios pala - Lift-off hinges - Paumelles

Ref.220



Ref./Cod.	mm Medidas Size Dimension	Agujeros x ømm Holes Trou	Ø Tornillo Screw Vis
220/2072	60x54x1.5	6x5	4x20
220/2385	80x65x2	6x5.5	4.5x25
220/2386	100x79x2	6x5.5	4.5x25

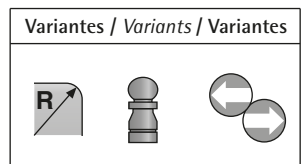

Materiales- (Acabados) / Materials- (Treatments) / Matériaux- (Finitions)

H (PU) - (ZI) - (LA)

L (PU)

1304 (B)



Ref.533

Pernios doble escuadra - Double square lift-off hinges - Paumelles

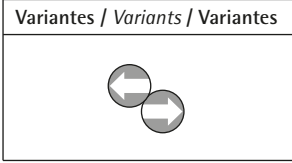

Ref./Cod.	mm Medidas Size/Dimension A x B x C x D	Agujeros x ømm Holes Trou	Ø Tornillo Screw Vis
533/2693	120 x 65 x 3 x 40	8x6	4.5x25

Materiales- (Acabados) / Materials- (Treatments) / Matériaux- (Finitions)

I304 (SA)

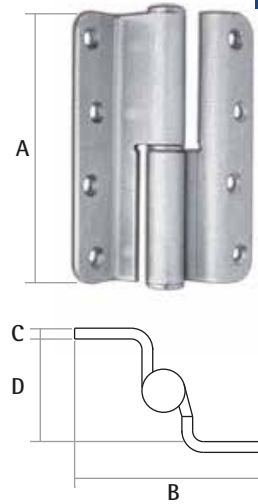

Ref.160

Pernios pala larga - Flag lift-off hinge - Paumelles

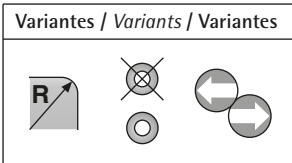

Ref./Cod.	mm Medidas Size/Dimension AxBxC	E	F	Agujeros x ømm Holes Trou
160/262	100x82x2.5	35	48.5	6x6
160/263	100x100x2.5	44	48.5	6x6
160/260	100x86x3	35	48.5	6x6
160/261	100x100x3	42	48.5	6x6

Materiales- (Acabados) / Materials- (Treatments) / Matériaux- (Finitions)

H (PU)
I304 (B) - (SA)
I316 (B) - (SA)

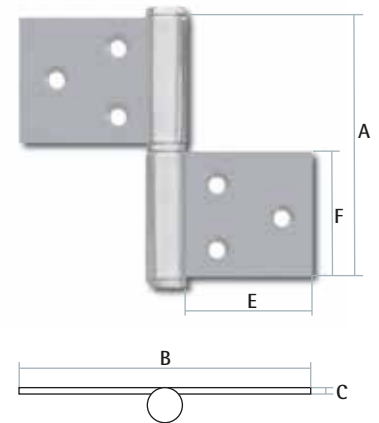

Ref.160

Pernio para soldar pala corta - Flag lift-off hinge for welding - Paumelle pour souder

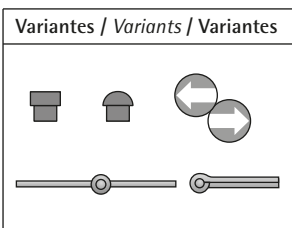

Ref./Cod.	mm Medidas Size/Dimension AxBxC	E	F	u.
160/4605	62x26x2	8	30	25
160/4606	82x44x2	16	40	20
160/4607	82x44x3	15	40	10
160/4608	103x44x3	15	50	10
160/4609	113x44x3	13	55	5
160/4610	124x52x4	16	60	5

Materiales- (Acabados) / Materials- (Treatments) / Matériaux- (Finitions)

H (PU)
I304 (B)
I316 (B)



Pernios torneados para soldar - *Butt hinges for welding* - Paumelle pour souder

Ref.332



Ref./Cod.	mm Medidas Size Dimension	
332/1578	ø8x50	50
332/1887	ø8x30	50
332/1016	ø10x60	50
332/1017	ø12x70	50
332/1018	ø14x80	25
332/1019	ø16x100	25
332/1020	ø18x110	10
332/1021	ø20x120	10
332/1022	ø25x150	5
332/4567	ø30x150	5

Materiales- (Acabados) / Materials- (Treatments) / Matériaux- (Finitions)

I303 (B)

Características / Characteristics / Caractéristiques

Con arandela de latón /
With brass washer /
Avec rondelle en laiton



Pernios gota para soldar - *Butt hinges for welding* - Paumelle pour souder

Ref.738



Ref./Cod.	mm Medidas Size Dimension	
738/2625	ø10x60	50
738/2626	ø13x80	25
738/2627	ø16x100	10
738/4604	ø20x120	10

Materiales- (Acabados) / Materials- (Treatments) / Matériaux- (Finitions)

I303 (B)

Características / Characteristics / Caractéristiques

Con arandela de latón /
With brass washer /
Avec rondelle en laiton



Variantes / Variants / Variantes

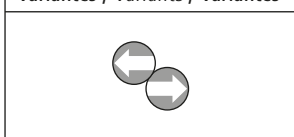

Ref./Cod.	mm Medidas Size Dimension	Agujeros x ømm Holes Trou	Ø Tornillo Screw Vis
155/253	116x45x2.5	4x6.5	5x25
155/2678	101x76x3	8x6.5	5x25
149/4239	100x77x3	4x5	4.5x25

Materiales- (Acabados) / Materials- (Treatments) / Matériaux- (Finitions)

1304 (SA)



Ref. 155/253



Ref. 155/2678



Ref. 149/4239



Variantes / Variants / Variantes

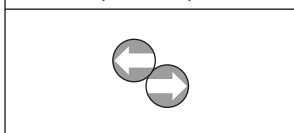

Ref./Cod.	mm Medidas Size/Dimension AxBxC	Agujeros x ømm Holes Trou
160/4668	102x95,5x2,5	2x6 + 3x5,5

Materiales- (Acabados) / Materials- (Treatments) / Matériaux- (Finitions)

1304 (SA)

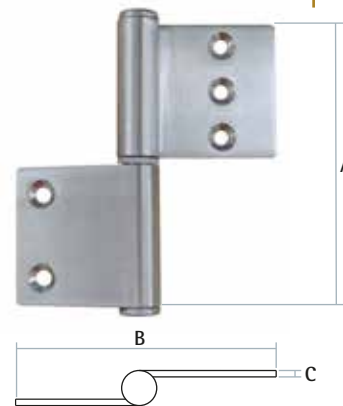

Pernios especiales - Special lift-off hinges - Paumelles spéciaux

Ref.156



Ref./Cod.	mm Medidas Size Dimension	Agujeros x ømm Holes Trou	Ø Tornillo Screw Vis
156/254	76x76x3	3x5.5	4.5x25
		3xM5	M5

Variantes / Variants / Variantes



Materiales- (Acabados) / Materials- (Treatments) / Matériaux- (Finitions)

I304 (SA)



Pernios para cercos metálicos - Lift-off hinges for metal fences - Paumelles pour profils

Ref.149



Ref./Cod.	mm Medidas Size Dimension	Agujeros x ømm Holes Trou	Ø Tornillo Screw Vis
149/247	100x77x3	4x5	4.5x25

Variantes / Variants / Variantes



Materiales- (Acabados) / Materials- (Treatments) / Matériaux- (Finitions)

H (PU) - (ZI)

I304 (SA)



Recibidor para perfil - Fixed element - Carters d'huissierie

Ref.356



Ref./Cod.	mm Medidas Size Dimension	Agujeros x ømm Holes Trou	Ø Tornillo Screw Vis
356/1231	20x83.5x2	4x5	4.5x25

Variantes / Variants / Variantes



Materiales- (Acabados) / Materials- (Treatments) / Matériaux- (Finitions)

H (ZI)



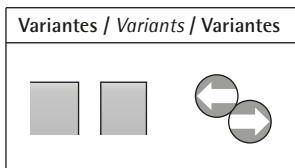

Ref./Cod.	mm Medidas Size Dimension	Agujeros x ømm Holes Trou	Ø Tornillo Screw Vis
150/248	100x77x3	4x5 6.5x15	4.5x25



Materiales- (Acabados) / Materials- (Treatments) / Matériaux- (Finitions)

H	(PU) - (ZI)
I304	(SA)

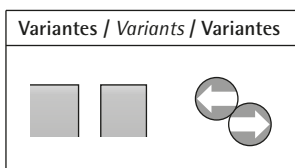

Ref./Cod.	mm Medidas Size Dimension	Agujeros x ømm Holes Trou	Ø Tornillo Screw Vis
151/249	100x88x2.5	4x6 6x43	4.5x25



Materiales- (Acabados) / Materials- (Treatments) / Matériaux- (Finitions)

H	(PU) - (ZI)
I304	(SA)

CERRADURAS MUEBLE / *LOCKS FOR FURNITURE* / SERRURES POUR MEUBLES PAG. 94-96

CERRADURAS MUEBLE CLÁSICAS / *CLASSICAL LOCKS* / SERRURES CLASSIQUES PAG. 97-109



Cerradura para cajón - *Drawer lock* - Serrure de tiroir

Ref.610



Ref./Cod.	Medidas (mm) Size/Dimension A x B x C	D x L	Características Characteristics Caractéristiques
610/4050	40x40x6	∅19x21	Llaves aleatorias en caja/ <i>With different keys</i> /Avec des clés différentes
610/4050I	40x40x6	∅19x21	Con llaves iguales/ <i>With the same keys</i> /Avec les mêmes clés

Materiales- (Acabados) /
Materials- (Treatments) /
Matériaux- (Finitions)

■ H (CR)

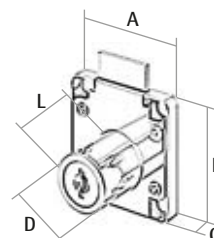

Cerradura para puerta de armario - *Door lock* - Serrure porte

Ref.610



Ref./Cod.	Medidas (mm) Size/Dimension A x B x C	D x L	Características Characteristics Caractéristiques
610/4051	40x40x6	∅19x21	Llaves aleatorias en caja/ <i>With different keys</i> /Avec des clés différentes
610/4051I	40x40x6	∅19x21	Con llaves iguales/ <i>With the same keys</i> /Avec les mêmes clés

Materiales- (Acabados) /
Materials- (Treatments) /
Matériaux- (Finitions)

■ H (CR)

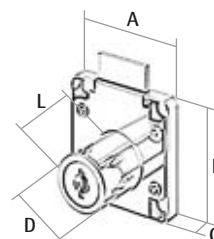

Cerradura para puerta corredera - *Lock for sliding door* - Serrure per porte coulissante

Ref.610



Ref./Cod.	Medidas (mm) Size/Dimension A x B x C	D x L	Características Characteristics Caractéristiques
610/4052	40x40x6	∅19x21	Llaves aleatorias en caja/ <i>With different keys</i> /Avec des clés différentes
610/4052I	40x40x6	∅19x21	Con llaves iguales/ <i>With the same keys</i> /Avec les mêmes clés

Materiales- (Acabados) /
Materials- (Treatments) /
Matériaux- (Finitions)

■ H (CR)

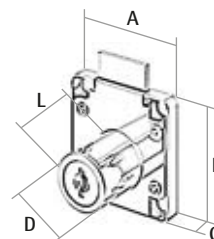

Ref./Cod.	mm Medidas Size Dimension	Características Characteristics Caractéristiques
610/4054	ø19x largo 16	Llaves aleatorias en caja/ <i>With different keys</i> /Avec des clés différentes
610/4054I	ø19x largo 16	Con llaves iguales/ <i>With the same keys</i> /Avec les mêmes clés
610/4055	ø19x largo 20	Llaves aleatorias en caja/ <i>With different keys</i> /Avec des clés différentes
610/4055I	ø19x largo 20	Con llaves iguales/ <i>With the same keys</i> /Avec les mêmes clés
610/4056	ø19x largo 25	Llaves aleatorias en caja/ <i>With different keys</i> /Avec des clés différentes
610/4056I	ø19x largo 25	Con llaves iguales/ <i>With the same keys</i> /Avec les mêmes clés
610/4057	ø19x largo 30	Llaves aleatorias en caja/ <i>With different keys</i> /Avec des clés différentes
610/4057I	ø19x largo 30	Con llaves iguales/ <i>With the same keys</i> /Avec les mêmes clés

Materiales- (Acabados) / Materials- (Treatments) / Matériaux- (Finitions)

H (CR)

Ref./Cod.	mm Medidas Size Dimension	Características Characteristics Caractéristiques
610/4058	ø19x24	Llaves aleatorias en caja/ <i>With different keys</i> /Avec des clés différentes
610/4058I	ø19x24	Con llaves iguales/ <i>With the same keys</i> /Avec les mêmes clés

Con pulsador 10mm recorrido - *With push system (10mm)* - Avec poussoir (10mm)

Materiales- (Acabados) / Materials- (Treatments) / Matériaux- (Finitions)

H (CR)

Cerradura puerta de cristal - Locks for glass door - Serrure porte en verre

Ref.610



Ref./Cod.	mm Medidas Size Dimension	Características Characteristics Caractéristiques
610/4053	32x35x7	Llaves aleatorias en caja/With different keys/Avec des clés différentes
610/4053I	32x35x7	Con llaves iguales/With identical keys/Avec des clés identiques

Para cristal de grosor máx. 7mm. - Max. glass thickness 7mm - Verre max. 7mm

Materiales- (Acabados) / Materials- (Treatments) / Matériaux- (Finitions)

H (CR)



Cerradura puerta cristal corredera - Locks for glass door - Serrure pour vitrine coulissante

Ref.610



Ref./Cod.	mm Medidas Size Dimension	Características Characteristics Caractéristiques
610/4059	Ø20x140	Llaves aleatorias en caja/With different keys/Avec des clés différentes
610/4059I	Ø20x140	Con llaves iguales/With identical keys/Avec des clés identiques

Para cristal de grosor máx. 9mm. - Max. glass thickness 9mm - Verre max. 9mm

Materiales- (Acabados) / Materials- (Treatments) / Matériaux- (Finitions)

H (CR)





Ref./Cod.	Denominación Name Dénomination
446/4616	Conjunto cerradura completa con sus accesorios y tornillos <i>Full set lock for small wooden box</i> Kit complet serrure de coffret



Ref./Cod.	Denominación Name Dénomination
446/4617	Conjunto cerradura y contrafrente con tornillos <i>Lock with front trim panel for small wooden box</i> Serrure de coffret avec plaque frontal



Ref./Cod.	Denominación Name Dénomination
446/4618	Conjunto cerradura y pasador con tornillos <i>Lock with pin for small wooden box</i> Serrure de coffret avec broche



Ref./Cod.	Denominación Name Dénomination
446/1809	Llave / Key / Clé
446/1810	Bocallave / Key escutcheon / Entrée clé
446/1805	Pasador para cerradura / Pin to lock / Axe



446/1809



446/1810



446/1805

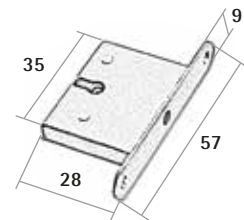

Características / Characteristics / Caractéristiques

Cerradura de calidad en latón para estuches y pequeñas cajitas.
Se puede combinar con varios accesorios, con frontal de cierre en placa o pasador. Sirve para puertas normales o correderas gracias al diseño de su pestillo.
*High quality brass lock for small wooden boxes.
Either with front trim panel either with pin. Can be used either with standard either with sliding doors.*
Serrure de qualité en laiton pour des coffrets.
Divers combinaisons possibles, avec plaque frontal ou avec broche. Pour des portes standard ou coulissantes

Materiales- (Acabados) / Materials- (Treatments) / Matériaux- (Finitions)

L (O) - (NI)



Cerraduras de embutir - Mortise locks - Serrures à encastrer

Mod.205 Ref.1205



Ref./Cod.	Medidas (mm) Size/Dimension A x B x Entrada	Agujeros x ømm Holes Trou	Ø Tornillo Screw Vis
1205/1500	80x13x10	2x4,20	3,5x25
1205/1501	80x13x15	2x4,20	3,5x25
1205/1502	80x13x20	2x4,20	3,5x25
1205/1503	80x13x25	2x4,20	3,5x25
1205/1504	80x13x30	2x4,20	3,5x25
1205/1505	80x13x35	2x4,20	3,5x25
1205/1506	80x13x40	2x4,20	3,5x25
1205/1507	80x13x50	2x4,20	3,5x25
1205/1508	80x13x60	2x4,20	3,5x25

Variantes/ Variants/ Variantes

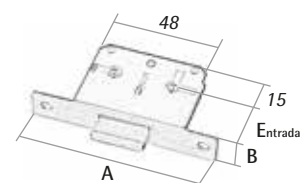

Características/ Characteristics / Caractéristiques

Tres gorjas que permiten seis combinaciones diferentes. (Para llaves de latón, no incluidas)
 Three levers allowing six different combination. (For brass keys, not included)
 Trois levieos, qui permettent six combinaisons. (Pour les clés de cuivres, non inclus)

Materiales- (Acabados) / Materials- (Treatments) / Matériaux- (Finitions)

L (SA) Solo frente / Front plate / Plaque frontale



Cerraduras de embutir - Mortise locks - Serrures à encastrer

Mod.200 Ref.1200



Ref./Cod.	Medidas (mm) Size/Dimension A x B x Entrada	Agujeros x ømm Holes Trou	Ø Tornillo Screw Vis
1200/1512	80x13x10	2x4,20	3,5x25
1200/1513	80x13x15	2x4,20	3,5x25
1200/1514	80x13x20	2x4,20	3,5x25
1200/1515	80x13x25	2x4,20	3,5x25
1200/1516	80x13x30	2x4,20	3,5x25
1200/1517	80x13x35	2x4,20	3,5x25
1200/1518	80x13x40	2x4,20	3,5x25
1200/1519	80x13x50	2x4,20	3,5x25
1200/1520	80x13x60	2x4,20	3,5x25

Variantes/ Variants/ Variantes

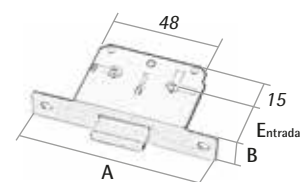

Características/ Characteristics / Caractéristiques

Tres entradas. Combinación única. (Para llaves de Zamac, no incluidas)
 Three keyholes. Single combination. (For Zamac keys, not included)
 Trois entres. Combinaison unique. (Pour les clés de zamac, non inclus)

Materiales- (Acabados) / Materials- (Treatments) / Matériaux- (Finitions)

L (SA) Solo frente / Front plate / Plaque frontale



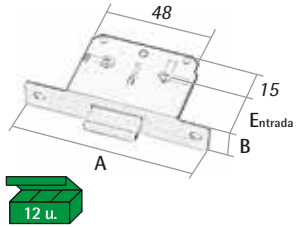
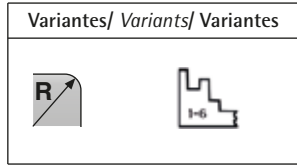

Ref./Cod.	Medidas (mm) Size/Dimension A x B x Entrada	Agujeros x ømm Holes Trou	Ø Tornillo Screw Vis
1206/1509	80x13x30	2x4,20	3,5x25
1206/1510	80x13x35	2x4,20	3,5x25

Características/ Characteristics/ Caractéristiques

Tres gorjas que permiten seis combinaciones diferentes. (Para llaves de latón, no incluidas)
Three levers allowing six different combination. (For brass keys, not included)
 Trois leviers, qui permettent six combinaisons. (Pour les clés de cuivres, non inclus)

Materiales- (Acabados) / Materials- (Treatments) / Matériaux- (Finitions)

L (SA) Frente y contrafrente / *Front plate and strike plate / Plaques*

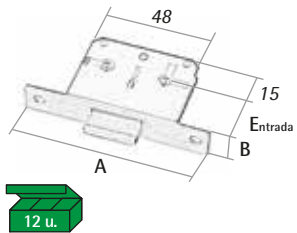
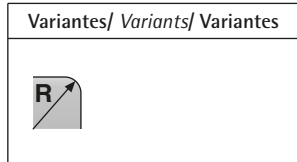

Ref./Cod.	Medidas (mm) Size/Dimension A x B x Entrada	Agujeros x ømm Holes Trou	Ø Tornillo Screw Vis
1220/1521	80x13x30	2x4,20	3,5x25
1220/1522	80x13x35	2x4,20	3,5x25

Características/ Characteristics/ Caractéristiques

Tres entradas. Combinación única. (Para llaves de Zamac, no incluidas)
Three keyholes. Single combination. (For Zamac keys, not included)
 Trois entres. Combinaison unique. (Pour les clés de zamac, non inclus)

Materiales- (Acabados) / Materials- (Treatments) / Matériaux- (Finitions)

L (SA) Frente y contrafrente / *Front plate and strike plate / Plaques*

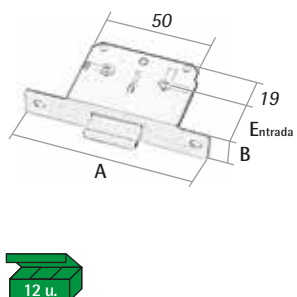
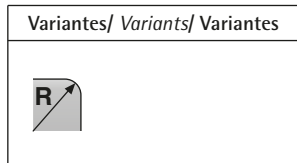

Ref./Cod.	Medidas (mm) Size/Dimension A x B x Entrada	Agujeros x ømm Holes Trou	Ø Tornillo Screw Vis
1190/1523	80x13x20	2x4,20	3,5x25
1190/1524	80x13x25	2x4,20	3,5x25
1190/1525	80x13x30	2x4,20	3,5x25
1190/1526	80x13x35	2x4,20	3,5x25
1190/1527	80x13x40	2x4,20	3,5x25

Características/ Characteristics/ Caractéristiques

Tres entradas. Combinación única. (Para llaves de Zamac, no incluidas)
Three keyholes. Single combination. (For Zamac keys, not included)
 Trois entres. Combinaison unique. (Pour les clés de zamac, non inclus)

Materiales- (Acabados) / Materials- (Treatments) / Matériaux- (Finitions)

H (LA) Solo frente / *Front plate / Plaque frontale*



Cerraduras de embutir - Mortise locks - Serrures à encastrer

Mod.502 Ref.1502



Ref./Cod.	Medidas (mm) Size/Dimension A x B x Entrada	Agujeros x ømm Holes Trou	Ø Tornillo Screw Vis
1502/1528	80x13x20	2x4,20	3,5x25
1502/1529	80x13x25	2x4,20	3,5x25
1502/1530	80x13x30	2x4,20	3,5x25
1502/1535	80x13x35	2x4,20	3,5x25
1502/1540	80x13x40	2x4,20	3,5x25

Variantes/ Variants/ Variantes

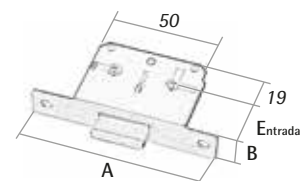

Características/ Characteristics / Caractéristiques

Tres entradas. Combinación única. (Para llaves de Zamac, no incluidas)
Three keyholes. Single combination. (For Zamac keys, not included)
Trois entres. Combinaison unique. (Pour les clés de zamac, non inclus)

Materiales- (Acabados) / Materials- (Treatments) / Matériaux- (Finitions)

H (LA) Solo frente / Front plate / Plaque frontale



Cerraduras de embutir - Mortise locks - Serrures à encastrer

Mod.211 Ref.1211



Ref./Cod.	Medidas (mm) Size/Dimension A x B x Entrada	Agujeros x ømm Holes Trou	Ø Tornillo Screw Vis
1211/1511	80x13x10	2x3,00	3,5x25

Variantes/ Variants/ Variantes

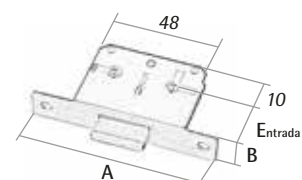
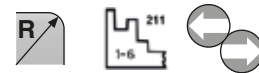

Características/ Characteristics / Caractéristiques

Tres gorjas que permiten seis combinaciones diferentes. (Para llaves de latón especiales, no incluidas)
Three levers allowing six different combination. (For special brass keys, not included)
Trois levieos, qui permettent six combinaisons. (Pour les clés de cuivres spéciaux, non inclus)

Materiales- (Acabados) / Materials- (Treatments) / Matériaux- (Finitions)

L (SA) Solo frente / Front plate / Plaque frontale



Frente suelto (chapa marco) - Frame plate - Plaque réceptrice

Ref.1200



Ref./Cod.	Medidas (mm) Size/Dimension	Agujeros x ømm Holes Trou	Ø Tornillo Screw Vis
1200/4828	80x13x1	2x3,00	3,5x25

Variantes/ Variants/ Variantes



Materiales- (Acabados) / Materials- (Treatments) / Matériaux- (Finitions)

L (B)



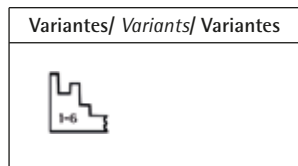

Ref./Cod.	Medidas (mm) Size/Dimension A x B x Entrada	Agujeros x ømm Holes Trou	Ø Tornillo Screw Vis
1207/1546	50x10x20	4x3,00	3,5x25
1207/1547	50x10x25	4x3,00	3,5x25
1207/1548	50x10x30	4x3,00	3,5x25

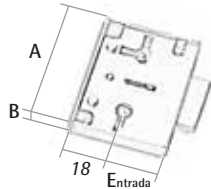
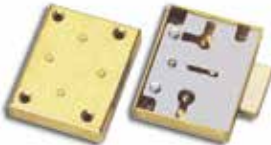

Características/ Characteristics / Caractéristiques

Tres gorjas que permiten seis combinaciones diferentes. (Para llaves de latón, no incluidas)
Three levers allowing six different combination. (For brass keys, not included)
 Trois leviers, qui permettent six combinaisons. (Pour les clés de cuivres, non inclus)

Materiales- (Acabados) / Materials- (Treatments) / Matériaux- (Finitions)

H (LA) Caja / Case / Caisse



Ref./Cod.	Medidas (mm) Size/Dimension A x B x Entrada	Agujeros x ømm Holes Trou	Ø Tornillo Screw Vis
1307/1950	50x10x20	4x3,00	3,5x25
1307/1951	50x10x25	4x3,00	3,5x25
1307/1952	50x10x30	4x3,00	3,5x25

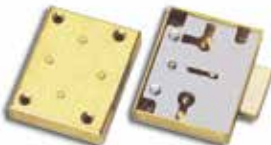

Características/ Characteristics / Caractéristiques

Tres entradas. Combinación única. (Para llaves de Zamac, no incluidas)
Three keyholes. Single combination. (For Zamac keys, not included)
 Trois entres. Combinaison unique. (Pour les clés de zamac, non inclus)

Materiales- (Acabados) / Materials- (Treatments) / Matériaux- (Finitions)

H (LA) Caja / Case / Caisse



Ref./Cod.	Medidas (mm) Size/Dimension A x B x Entrada	Agujeros x ømm Holes Trou	Ø Tornillo Screw Vis
1500/1953	50x8,4x20	4x3,00	3,5x25
1500/1954	50x8,4x25	4x3,00	3,5x25
1500/1955	50x8,4x30	4x3,00	3,5x25
1500/1533	50x8,4x35	4x3,00	3,5x25
1500/1534	50x8,4x40	4x3,00	3,5x25

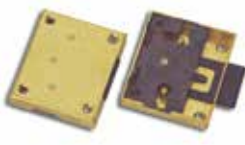

Características/ Characteristics / Caractéristiques

Tres entradas. Combinación única. (Para llaves de Zamac, no incluidas)
Three keyholes. Single combination. (For Zamac keys, not included)
 Trois entres. Combinaison unique. (Pour les clés de zamac, non inclus)

Materiales- (Acabados) / Materials- (Treatments) / Matériaux- (Finitions)

H (LA) Caja / Case / Caisse



Cerraduras de sobreponer - Surface mounted locks - Serrures à appliquer

Mod.208 Ref.1208



Ref./Cod.	Medidas (mm) Size/Dimension A x B x C x Entrada	Agujeros x ømm Holes Trou	Ø Tornillo Screw Vis
1208/1549	60x22x8,5x11	4x3,20	3x16

Características / Characteristics / Caractéristiques

Especial para vitrinas. Seis combinaciones. (Para llaves de latón, no incluidas)
Special for display cabinets. Six combination. (For brass keys, not included)
Special vitrine. 6 Combinaison. (Pour les clés de cuivres, non inclus)

Materiales- (Acabados) / Materials- (Treatments) / Matériaux- (Finitions)

■ (LA) Caja / Case / Caisse

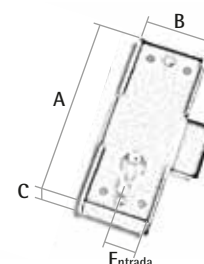

Cerraduras de sobreponer - Surface mounted locks - Serrures à appliquer

Mod.108 Ref.1108



Ref./Cod.	Medidas (mm) Size/Dimension A x B x C x Entrada	Agujeros x ømm Holes Trou	Ø Tornillo Screw Vis
1108/1957	60x22x8,5x11	4x3,20	3x16

Características / Characteristics / Caractéristiques

Especial para vitrinas. Combinación única. (Para llaves de Zamac, no incluidas)
Special for display cabinets. Single combination. (For Zamac keys, not included)
Special vitrine. Combinaison unique. (Pour les clés de zamac, non inclus)

Materiales- (Acabados) / Materials- (Treatments) / Matériaux- (Finitions)

■ (LA) Caja / Case / Caisse

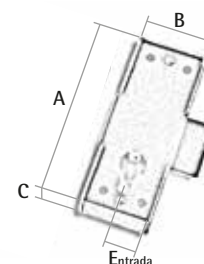

Escuadras de cierre para cerraduras y fallebas - Closing square for locks - Carré de fermeture pour serrures

Ref.1505



Ref./Cod.	mm Medidas Size Dimension	Agujeros x ømm Holes Trou	Ø Tornillo Screw Vis
1505/2062	30x13x8,5	2x3	2,5x12

Materiales- (Acabados) / Materials- (Treatments) / Matériaux- (Finitions)

(LA) - (NI)



Ref./Cod.	Medidas (mm) Size/Dimension A x B x C x Entrada	Agujeros x ømm Holes Trou	Ø Tornillo Screw Vis
1503/1958	70x37x20x18,5	4x3,50	3x30
1505/1959	74x37x20x18,5	4x3,50	3x30

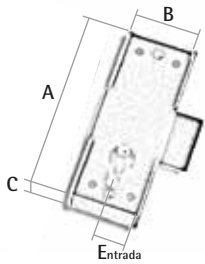

Características/ Characteristics / Caractéristiques

Dos entradas. Una gorja. Combinación única. (Para llaves de Zamac, no incluidas)
Two keyholes. One lever. Single combination. (For Zamac keys, not included)
Deux entres. Un levier. Unique combinaison. (Pour les clés de zamac, non inclus)

Materiales- (Acabados) / Materials- (Treatments) / Matériaux- (Finitions)

PLAS (MR) - (BL) Caja / Case / Caisse



1503



1505

Ref.1503-1505 **Accesorios y varillas para fallebas - Accessories and rods - Accessoires et tiges (1503 / 1505)**

Ref./Cod.	Denominación Name Dénomination	
1503/2060	Conjunto accesorios 1503	Para varilla de Ø6mm
1505/2061	Conjunto accesorios 1505	Para varilla de Ø6mm

Características/ Characteristics / Caractéristiques

Los accesorios están compuestos por 4 puentes, 2 ganchos y 2 tornillos excéntricos.
Contains 4 bridges, 2 hooks and 2 eccentric screws.
Il contient 4 ponts, 2 crochets et 2 vis excentrique.

Materiales- (Acabados) / Materials- (Treatments) / Matériaux- (Finitions)

PLAS (MR) - (BL)

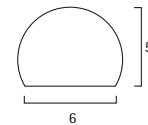

Ref./Cod.	Denominación Name Dénomination	
1505/2043	Varilla/Rod/Tige 1000 mm Ø6x5	Para fallebas 1503 y 1505
1505/2044	Varilla/Rod/Tige 1250 mm Ø6x5	Para fallebas 1503 y 1505
1505/2045	Varilla/Rod/Tige 1500 mm Ø6x5	Para fallebas 1503 y 1505

Materiales- (Acabados) / Materials- (Treatments) / Matériaux- (Finitions)

H (PIMR) - (PIBL)





Ref./Cod.	Medidas (mm) Size/Dimension A x B x C x Entrada	Agujeros x ømm Holes Trou	Ø Tornillo Screw Vis	
1213/1962	110x22x11x11	4x3,20	3x25	
1215/1965	110x22x11x11	4x3,20	3x25	

Variantes/ Variants/ Variantes



Ref.1215

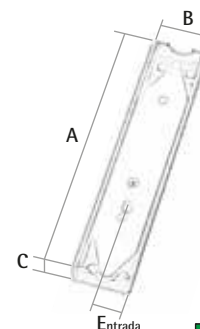

Características / Characteristics / Caractéristiques

Ref.1213 Combinación única. (Para llaves de Zamac, no incluidas)
Cerraduras de varillas para sobreponer en armarios, puertas, etc.
Standard combination. (For Zamac keys, not included)
Surface-mount locks with rod in wardrobes, doors, etc.
Combinaison unique. (Pour les clés de zamac, non inclus)
Fermeture de tiges pour sur les armoires, portes, etc...

Ref.1215 Seis combinaciones. (Para llaves de latón, no incluidas)
Cerraduras de varillas para sobreponer en armarios, puertas, etc.
Six combinations. (For brass keys, not included)
Surface-mount locks with rod in wardrobes, doors, etc.
Six Combinaison. (Pour les clés de cuivres, non inclus)
Fermeture de tiges pour sur les armoires, portes, etc...

Materiales- (Acabados) / Materials- (Treatments) / Matériaux- (Finitions)

H (LA) - (PA) - (NI) Caja / Case / Caisse

Accesorios y varillas para Fallebas - *Accessories and rods* - *Accessoires et tiges (1213 / 1215)*

Ref.1213

Ref./Cod.	Denominación Name Dénomination
1213/2055	Conjunto accesorios para fallebas 1213 y 1215

Características / Characteristics / Caractéristiques

Los accesorios están compuestos por 4 puentes y 2 chapas marco
Contains 4 bridges and 2 frame plates.
Il contient 4 ponts et 2 plaques réceptrice.

Materiales- (Acabados) / Materials- (Treatments) / Matériaux- (Finitions)

H (LA) - (NI) - (PA)



Ref./Cod.	Denominación Name Dénomination	
1213/2038	Varilla/Rod/Tige 1000 mm Ø8x3	Para fallebas 1213 y 1215
1213/2039	Varilla/Rod/Tige 1250 mm Ø8x3	Para fallebas 1213 y 1215

Materiales- (Acabados) / Materials- (Treatments) / Matériaux- (Finitions)

H (LA) - (PA)

Mod.213-215

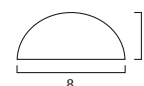

Variantes/ Variants/ Variantes

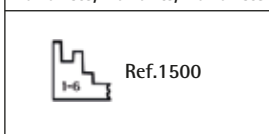

Ref.1500

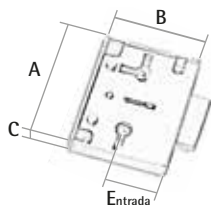

12 u.

Ref./Cod.	Medidas (mm) Size/Dimension A x B x C x Entrada	Agujeros x ømm Holes Trou	Ø Tornillo Screw Vis
1500/1968	55x51x16x31	4x3,50	3x25
1507/1971	55x51x16x31	4x3,50	3x25

Características / Characteristics / Caractéristiques

Ref.1500 Dos entradas. Tres gorjas. Seis combinaciones. (Para llaves de latón, no incluidas)
Ganchos y bridas de acetal. Cerraduras para superponer en armarios, puertas, etc.
Two keyholes. Three lever. Six combinations. (For brass keys, not included)
Catch hooks and rod guides of acetalic resin. Surface mounted locks with rods.
Deux entrées. Trois leviers qui permettent six Combinaison.
(Pour les clés de cuivres, non inclus) Crochets et brides en acetone.

Ref.1507 Dos entradas. Combinación única. (Para llaves de Zamac, no incluidas)
Ganchos y bridas de acetal. Cerraduras de varillas para superponer en armarios, puertas, etc.
Two keyholes. Single combination. (For Zamac keys, not included)
Black glazed metal-catch hooks rod guides. Surface mounted locks with rods.
Deux entrées. Combinaison unique. (Pour les clés de zamac, non inclus)
Crochets et brides en zamac. Fermeture de baguettes pour sur les armoires, portes, etc...

Materiales- (Acabados) / Materials- (Treatments) / Matériaux- (Finitions)

H (LA) - (PA) - (NI) Caja / Case / Caisse

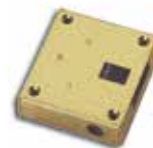

Ref.1500 -1507 Accesorios y varillas para fallebas - *Accessories and rods* - *Accessoires et tiges* (1500 / 1507)

Ref./Cod.	Denominación Name Dénomination	
1500/2063	Conjunto accesorios 1500	Para varilla de Ø8mm
1507/2064	Conjunto accesorios 1507	Para varilla de Ø6mm

Características/ Characteristics / Caractéristiques

Los accesorios están compuestos por 4 puentes, 2 ganchos y 2 tornillos excéntricos.
Contains 4 bridges, 2 hooks and 2 eccentric screws.
Il contient 4 ponts, 2 crochets et 2 vis excentrique.

Materiales- (Acabados) / Materials- (Treatments) / Matériaux- (Finitions)

PLAS (NG)

Ref./Cod.	Denominación Name Dénomination	
1500/2046	Varilla/Rod/Tige 1000 mm Ø8x7	Para fallebas 1500
1500/2047	Varilla/Rod/Tige 1250 mm Ø8x7	Para fallebas 1500
1500/2048	Varilla/Rod/Tige 1500 mm Ø8x7	Para fallebas 1500
1507/2049	Varilla/Rod/Tige 1000 mm Ø6x5	Para fallebas 1507
1507/2050	Varilla/Rod/Tige 1250 mm Ø6x5	Para fallebas 1507
1507/2051	Varilla/Rod/Tige 1500 mm Ø6x5	Para fallebas 1507

Materiales- (Acabados) / Materials- (Treatments) / Matériaux- (Finitions)

H (LA) - (NI) - (PA)



12 u.

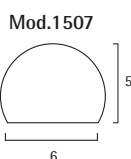
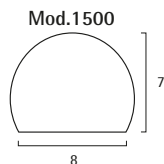



Ref./Cod.	Denominación Name Dénomination
2000/1974	Conjunto cremona con sus accesorios y tornillos <i>Kit espagnolette cremona with accessories and screws</i> Crémone espagnolette avec accessoires et vis

Características / Characteristics / Caractéristiques

Para ventanas y puertas rasadas o solapadas de apertura interna o externa. Con sistema de cierre con gancho giratorio.
For level or overlapping doors and windows, internal or external opening. With swivel catch hook closing system.
Pour fenêtres et portes, rasée ou sourniose à l'ouverture interne ou externe. Avec un système de fermeture pour crochet giratoire.



Materiales- (Acabados) / Materials- (Treatments) / Matériaux- (Finitions)

Z (LA.L) - (CR) - (PA.L)

Varillas para Cremona falleba - *Espagnolette cremones rods* -
Tiges pour crémones espagnolettes



Ref./Cod.	Denominación Name Dénomination	
2000/2052	Varilla 1000 mm Ø9x7	Para cremonas 2000
2000/2053	Varilla 1250 mm Ø9x7	Para cremonas 2000
2000/2054	Varilla 1500 mm Ø9x7	Para cremonas 2000

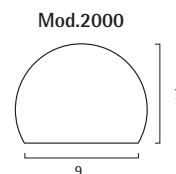

Materiales- (Acabados) / Materials- (Treatments) / Matériaux- (Finitions)

H (LA) - (CR) - (PA)



Llaves latón - Brass keys - Clés de laiton

Ref./Cod.	mm Medidas Size Dimension	Mod.	Combinaciones Combinations Combinaison
8000/1977	35	A	1,2,3,4,5 y 6
8000/1979	42	A	1,2,3,4,5 y 6
8000/1981	55	A	1,2,3,4,5 y 6
8000/1983	42	E	1,2,3,4,5 y 6
8000/1985	55	E	1,2,3,4,5 y 6
8000/1987	35	V	1,2,3,4,5 y 6
8000/1989	42	V	1,2,3,4,5 y 6



Materiales- (Acabados) / Materials- (Treatments) / Matériaux- (Finitions)

L (O) - (CU) - (NI)

Combinaciones de llaves / Combinations keys / Combinaison des clefs



Combinaciones especiales / Special combinations / Combinaison spéciale



Llaves zamac - Keys of zamac - Clés de zamac

Ref./Cod.	mm Medidas Size Dimension	Mod.	Combinaciones Combinations Combinaison
9000/1991	35	A	200
9000/1993	42	A	200
9000/1997	40	E	200
9000/1999	42	L	200
9000/2001	42	N	200
9000/2003	42	Z	200

Materiales- (Acabados) / Materials- (Treatments) / Matériaux- (Finitions)

Z (O) - (CU) - (NI)

Combinaciones de llaves / Combinations keys / Combinaison des clefs

Dentado Único Zamac.
Zamac Single Combination.
Zamac Combinaison Unique.

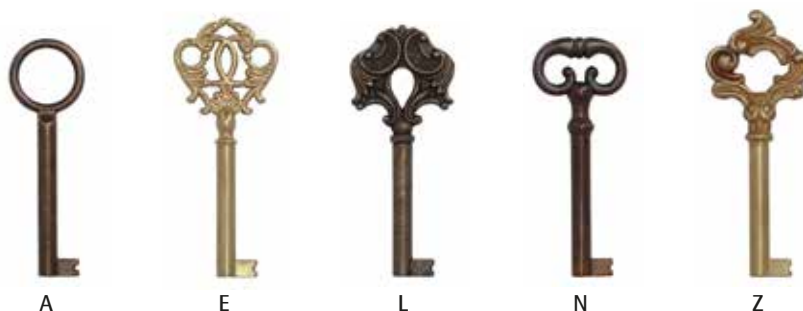

Bocallaves embutidas latón - *Keyhole plate embedded* - Entrée de clef encastré

Ref.38



Ref./Cod.	mm Medidas Size Dimension
38/3513	14x6
38/3512	16x6

Materiales- (Acabados) / *Materials- (Treatments)* / Matériaux- (Finitions)

L (PU)



200 u.

Llave para puertas de registro - *Revolving key* - Clef pour porte registre

Ref.344



Ref./Cod.	mm Medidas Size Dimension
344/1073	76x60

Materiales- (Acabados) / *Materials- (Treatments)* / Matériaux- (Finitions)

I303 (B)

Opción disponible en
agujero cuadrado

Also available with square
hole

Aussi disponibles avec le
trou carré



25 u.

Cilindro - *Cylinder* - Cylindre

Ref.505



Ref./Cod.	mm Medidas Size Dimension	Ø Tornillo Screw Vis	
505/2352	60	5x60	
505/2413	70	5x60	

Materiales- (Acabados) / *Materials- (Treatments)* / Matériaux- (Finitions)

I304 (SA)



6 u.

Ref./Cod.	Medidas (mm) Size/Dimension A x B x W x Entrada		Ø Tornillo Screw Vis
507/2340	235x23x72x55	Paso + Cilindro Llave	4x20/2x12
507/2341	235x23x85x55	Paso + Muletilla	4x20/2x12
507/2342	235x23x - x55	Solo Paso	4x20/2x12

Cerradura reversible / *Lock reversible* / Serrure réversible

Materiales- (Acabados) / *Materials- (Treatments)* / Matériaux- (Finitions)

1304 (SA) Frente / Front / Devanture

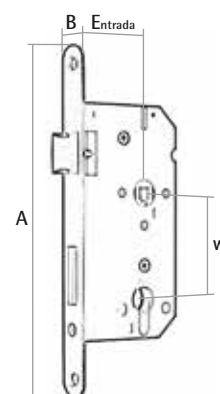

Ref.507/2340



Ref.507/2341

MANILLAS / *DOOR HANDLE SETS* / GARNITURE À BÉQUILLES POUR PORTES *PAG. 112-113*

TIRADORES / *PULL HANDLES* / POIGNÉES TIROIR *PAG. 113-114*

ACCESORIOS PUERTA / *DOOR ACCESSORIES* / ACCESSOIRES POUR PORTE *PAG. 115-116*

PICAPORTES / *TUBULAR DOOR LATCHES* / LOQUETS DE PORTES TUBULAIRES *PAG. 117-118*

CADENAS SEGURIDAD / *DOOR SECURITY DEVICES* / ACCESSOIRES DE SÉCURITÉ POUR PORTES *PAG. 119*

CERROJOS Y ALDABAS / *BOLTS AND BAR LATCHES* / VERROU DE BOX ET VERROU FLÉAU *PAG. 120-124*

CIERRES Y GOLPETES / *CATCHES AND LATCHES* / LOQUETEAUX *PAG. 125-127*

TOPES PUERTA Y DEDALES / *DOOR STOPPERS AND DUST PROOF STRIKES* / BUTÉE DE PORTE ET GÂCHES SOL *PAG. 128-129*



Manilla con rosetas - Door handle with rosette - Poignée de porte avec rosace

Ref.505



Ref./Cod.	mm Medidas Size Dimension
505/2355	19x135x60

Materiales- (Acabados) / Materials- (Treatments) / Matériaux- (Finitions)

I304 (SA)



Conjunto Embellecedor bocallave - Key escutcheon kit - Bordure entrée clé

Ref.505



Ref./Cod.	mm Medidas Size Dimension
505/2359	Ø53

Materiales- (Acabados) / Materials- (Treatments) / Matériaux- (Finitions)

I304 (SA)



Juego de condena para baño - Bathroom turn/indicator set - Bouton de condamnation

Ref.440



Ref./Cod.	mm Medidas Size Dimension
440/1739	Ø52

Materiales- (Acabados) / Materials- (Treatments) / Matériaux- (Finitions)

I304 (SA)



Ref.505

Conjunto manilla ovalada - Door handle kit - Poignée de porte

Ref./Cod.	mm Medidas Size Dimension	Variantes Options Variantes
505/2354	45x240	
505/4273	45x240	Con Bocallave



Materiales- (Acabados) / Materials- (Treatments) /
Matériaux- (Finitions)

1304 (SA)

Ref.505

Conjunto manilla cuadrada - Door handle square kit - Poignée de porte carré

Ref./Cod.	mm Medidas Size Dimension	Variantes Options Variantes
505/2696	170x170x2	
505/2353	170x170x2	Con Bocallave / With key escutcheon / Avec entrée clé
505/2697	170x170x2	Con Muletilla / With toggle / Avec bouton de condamnation



Materiales- (Acabados) / Materials- (Treatments) / Matériaux- (Finitions)

1304 (SA)



Ref.505

Manillón con rosetas - Handle with rosette - Poignée avec rosace

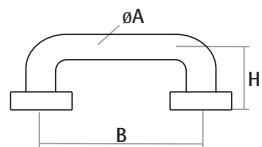

Ref./Cod.	Medidas (mm) Size/Dimension øA x B x H
505/2358	20x115x55
505/4823	20x200x55
505/4824	20x250x55
505/4825	20x300x55



Materiales- (Acabados) / Materials- (Treatments) / Matériaux- (Finitions)

1304 (SA)

Tirador pomo pulido - *Polished knob* - Boutin poli

Ref.364



Ref./Cod.	mm Medidas Size Dimension
364/1176	Ø35

Materiales- (Acabados) / Materials- (Treatments) / Matériaux- (Finitions)

L (PUE)

I303 (PUE)



Tirador redondo embutido - *Pull handle for sliding door* - Poignée cuvette à encastrer

Ref.505



Ref./Cod.	mm Medidas Size Dimension
505/2535	Ø40/Ø35x10
505/2537	Ø50/Ø40x10
505/2536	Ø65/Ø50x12

Materiales- (Acabados) / Materials- (Treatments) / Matériaux- (Finitions)

I303 (PUE)



Tirador rectangular embutido - *Pull handle for sliding door* - Poignée cuvette à encastrer

Ref.505



Ref./Cod.	mm Medidas Size Dimension
505/2356	81x37

Materiales- (Acabados) / Materials- (Treatments) / Matériaux- (Finitions)

I304 (SA)



Ref./Cod.	mm Medidas Size Dimension
749/4715	120x80x4



2 u.

Materiales- (Acabados) / *Materials- (Treatments)* / Matériaux- (Finitions)

■ H (LA) - (BR)

■ I304 (SA)

Acabados - *Treatments* - Finitions

Ref./Cod.	Número Number Nombre	mm Medidas Size Dimension
768-0	0	100
768-1	1	100
768-2	2	100
768-3	3	100
768-4	4	100
768-5	5	100
768-6	6	100
768-7	7	100
768-8	8	100
768-9	9	100



1 u.

Materiales- (Acabados) / *Materials- (Treatments)* / Matériaux- (Finitions)

■ H (PING)



Placas puerta (ciega) - Door push plates - Plaques de propreté pour porte

Ref.214

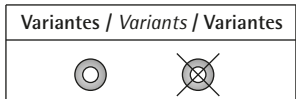

Ref./Cod.	mm Medidas Size Dimension	Aguj. x ømm Holes Trou	Ø Tornillo Screw Vis
214/4697	60x110x0,7	4x2,7	2,5x12
214/4699	70x130x0,7	4x2,7	2,5x12
214/4701	80x160x0,7	4x2,7	2,5x12

Materiales- (Acabados)

- 1304 (SA)
- L (SA)



Placas puerta (bocallave) - Door push plates - Plaques de propreté pour porte

Ref.214

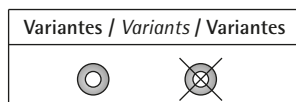

Ref./Cod.	mm Medidas Size Dimension	Aguj. x ømm Holes Trou	Ø Tornillo Screw Vis
214/4698	60x110x0,7	4x2,7	2,5x12
214/4700	70x130x0,7	4x2,7	2,5x12
214/4702	80x160x0,7	4x2,7	2,5x12

Materiales- (Acabados)

- 1304 (SA)
- L (SA)



Placas puerta (agujero Ø25,5) - Door push plates - Plaques de propreté pour porte

Ref.214

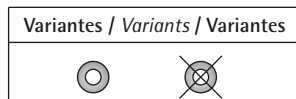
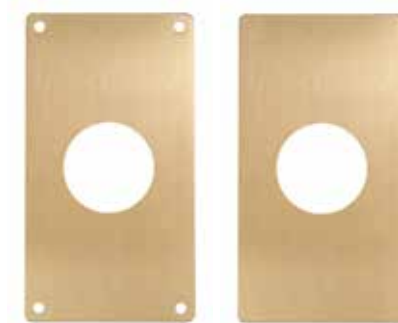

Ref./Cod.	mm Medidas Size Dimension	Aguj. x ømm Holes Trou	Ø Tornillo Screw Vis
214/4723	60x110x0,7	4x2,7	2,5x12
214/4724	70x130x0,7	4x2,7	2,5x12
214/4725	80x160x0,7	4x2,7	2,5x12

Materiales- (Acabados)

- 1304 (SA)
- L (SA)



Variantes / Variants / Variantes

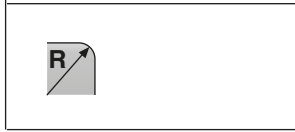

Ref./Cod.	mm Medidas / Size / Dimension			Ø Tornillo Screw Vis	
	A	B	C		
900/2012	70	35	25	3,5x25	
900/2014	70	45	25	3,5x25	
900/2013	70	60	25	3,5x25	
900/2015	70	70	25	3,5x25	
900/2016	57	35	25	3,5x25	
900/2018	57	45	25	3,5x25	
900/2017	57	60	25	3,5x25	
900/2019	57	70	25	3,5x25	

Características/ Characteristics/ Caractéristiques

Picaporte para manetas con cuadradillo de 8mm. Se sirve conjunto de picaporte, placa marco, y sus tornillos de montaje.

Latches for handles with 8mm spindle. Supplied with latch, frame plate, and screws.

Loquets pour boaton de porte. Servi avec des vis et plaque réceptrice.

Materiales- (Acabados) / Materials- (Treatments) / Matériaux- (Finitions)

 (LA) - (CR)

 (SA)

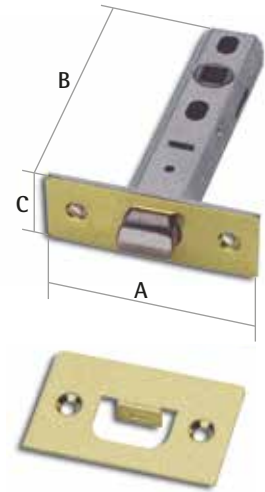

Ref./Cod.	mm Medidas Size Dimension
449/1832	8x8 exterior - 6x6 interior

Características/ Characteristics/ Caractéristiques

Reductor para utilizar el cuadradillo de 6mm en picaportes de 8mm.

Spindle sleeve to adapt 6mm spindle into 8mm latches.

Pour adapter nos pingnees de porte avec carre 8 mm aux serrures standard francaise avec carre 6 mm.

Materiales- (Acabados) / Materials- (Treatments) / Matériaux- (Finitions)

 (PU)



Ref./Cod.	mm Medidas Size Dimension	Agujeros x ømm Holes Trou	Ø Tornillo Screw Vis
764/4765	20x135	2x5	4x20

Cerradura reversible / *Lock reversible* / Serrure réversible

Materiales- (Acabados) / *Materials- (Treatments)* / Matériaux- (Finitions)

H (LA) Solo frente / *Front plate / Plaque frontale*

I304 (SA) Solo frente / *Front plate / Plaque frontale*

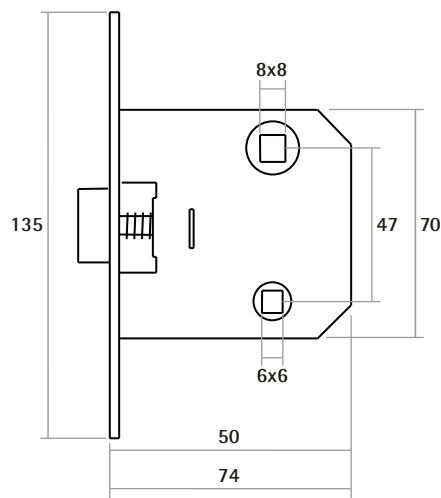

Ref.602 Cadena de seguridad chapa - *Door security chain* - Chaîne de sécurité pour portes

Ref./Cod.	mm	Medidas Size Dimension	
602/4112	42x88x1,3		Incluye tornillos / <i>Supplied with screws</i> / Livrée avec ses vis

Materiales- (Acabados) / *Materials- (Treatments)* / Matériaux- (Finitions)

H (LA) - (NI) - (BR)



Ref.602 Cadena de seguridad perfil- *Door security chain* - Chaîne de sécurité pour portes

Ref./Cod.	mm	Medidas Size Dimension	
602/4130	35x86x1,3		Incluye tornillos / <i>Supplied with screws</i> / Livrée avec ses vis

Materiales- (Acabados) / *Materials- (Treatments)* / Matériaux- (Finitions)

L (PU) - (NI)



Ref.602 Retenedor seguridad puerta - *Door security guard* - Arrêt de porte

Ref./Cod.	mm	Medidas Size Dimension	
602/4118	62x105x20		Incluye tornillos / <i>Supplied with screws</i> / Livrée avec ses vis

Materiales- (Acabados) / *Materials- (Treatments)* / Matériaux- (Finitions)

Z (LA) - (CR) - (BR)



Aldabillas para puertas y ventanas - Door and windows hook - Crochet

Ref.227



Ref./Cod.	mm Medidas Size Dimension	Variante Variant Variante
227/2722	Ø4x100	Con placa atornillable
227/2723	Ø4x150	Con placa atornillable
227/2724	Ø4x200	Con placa atornillable

Materiales- (Acabados) / Materials- (Treatments) / Matériaux- (Finitions)

L (PU)
I304 (B)



Aldabillas para puertas y ventanas - Door and windows hook - Crochet

Ref.227



Ref./Cod.	mm Medidas Size Dimension	Variante Variant Variante
227/4397	Ø3,3x50	Con hembra tira fondo
227/4396	Ø4x75	Con hembra tira fondo

Materiales- (Acabados) / Materials- (Treatments) / Matériaux- (Finitions)

H (ZI)



Conjunto de cierre guillotina - Sash window latch - Loquet pour fenêtre à guillotine

Ref.59



Ref./Cod.	Descripción Description Description
59/2513	Conjunto cierre / Set of closing / Jeu de fermeture
59/2517	Tancador suelto / Piece separately / Pièce séparément

Materiales- (Acabados) / Materials- (Treatments) / Matériaux- (Finitions)

L (PU) - (NI)



Ref./Cod.	mm Medidas Size Dimension	mm Cuadradillo Pin size Mesures goupille	Agujeros x ømm Holes Trou	Ø Tornillo Screw Vis	
880/2020 (1)	88,5x16x27	6	2x5,5	3,5x25	
880/2021 (1)	88,5x16x27	7	2x5,5	3,5x25	
880/2022 (1)	88,5x16x27	8	2x5,5	3,5x25	
880/2023 (2)	88,5x16x27	6	2x5,5	3,5x25	
880/2024 (2)	88,5x16x27	7	2x5,5	3,5x25	
880/2025 (2)	88,5x16x27	8	2x5,5	3,5x25	

Características / Characteristics / Caractéristiques

Los dos modelos con frontal.
Both models with frontal plate.
Les deux modèles avec plaque frontale.

Materiales- (Acabados) / Materials- (Treatments) / Matériaux- (Finitions)

 (BRI)

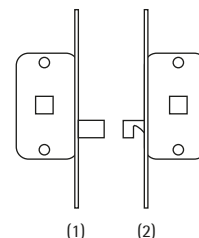

Ref.206

**Cerrojos para puertas o muebles - Small bolts for doors and furniture -
Petits verrous pour portes ou meubles**

Ref./Cod.	mm Medidas Size Dimension	Agujeros x ømm Holes Trou	Ø Tornillo Screw Vis	
206/315	30	6x3.5	3x16	
206/316	35	6x3.5	3x16	
206/317	40	6x3.5	3x16	
206/318	50	6x3.5	3x16	
206/319	60	8x3.5	3x16	

Materiales- (Acabados) / Materials- (Treatments) / Matériaux- (Finitions)

 (LA) - (BRI) - (NI)

 (PU)

 (B)



Ref.207

**Minipasadores pestaña para muebles - Mini flange pins for furniture -
Mini-chevilles agrafe pour meubles**

Ref./Cod.	mm Medidas Size Dimension	Agujeros x ømm Holes Trou	Ø Tornillo Screw Vis	
207/320	50	3x2.5	2x12	
207/321	70	3x2.5	2x12	

Materiales- (Acabados) / Materials- (Treatments) / Matériaux- (Finitions)

 (PU)





Ref./Cod.	mm Medidas largo Lenght size Mesures de longueur	∅ Tornillo Screw Vis
389/1317	50	3x12
389/1318	100	3x12
389/1319	150	3x12
389/1320	200	3x12
389/1321	250	3x12
389/1322	300	3x12
389/1323	400	3x12
389/1324	500	3x12
389/1325	600	3x12

Materiales- (Acabados) / Materials- (Treatments) / Matériaux- (Finitions)

- L (SA)
- I304 (SA)



Cerrojo - Bolt - Verrou



Ref./Cod.	mm Medidas Size Dimension	Características Characteristics Caractéristiques
600/4096	70x70x2	Con agujero para candado
600/4097	70x85x2	Con agujero para candado
600/4098	70x100x2	Con agujero para candado

Materiales- (Acabados) / Materials- (Treatments) / Matériaux- (Finitions)

- H (BRI) - (PING)

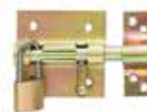

Cerrojo castellano - Ornamental bolt - Verrou rustique



Ref./Cod.	mm Medidas Size Dimension
600/4628	40
600/4629	50
600/4164	80
600/4165	100

Materiales- (Acabados) / Materials- (Treatments) / Matériaux- (Finitions)

- H (BRI) - (PING)



Ref./Cod.	mm Medidas / Size Dimension Ø x A
228/367	Ø8x120

Materiales- (Acabados) / Materials- (Treatments) / Matériaux- (Finitions)

L	(B)
1304	(B)
1316	(B)



Ref./Cod.	mm Medidas / Size Dimension Ø x L	Nº puentes incluidos Nº of parts included Nº à pièces inclus	
226/344	Ø8x150	3	
226/1852	Ø8x200	3	
226/1853	Ø8x250	3	
226/1854	Ø8x300	3	
226/1855	Ø8x400	4	
226/1856	Ø8x600	4	
226/1861	Ø12x250	3	
226/1862	Ø12x400	4	
226/1863	Ø12x600	4	

Materiales- (Acabados) / Materials- (Treatments) / Matériaux- (Finitions)

L	(B)
1304	(B)
1316	(B)

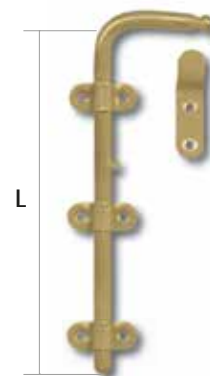

Ref./Cod.	A mm	Denominación Name Dénomination	Agujeros x ømm Holes Trou	Ø Tornillo Screw Vis	
69/8066	5	Plana/Punche/Plate	4x4	3x16	
69/8065	15	Tapabocas/Tompion/Bouchon	4x4	3x16	

Materiales- (Acabados) / Materials- (Treatments) / Matériaux- (Finitions)

H	(ZI) - (BRI) - (LA) - (PA)
L	(PU) - (NI)

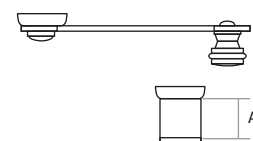

Aldabilla puerta corredera - Sliding door locker - Fléau pour volet porte coulissante

Ref.23

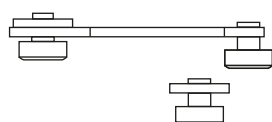

Ref./Cod.	mm Medidas Size Dimension	Funcionamiento Operation Fonctionnement	Agujeros x ømm Holes Trou	Ø Tornillo Screw Vis	
23/8025	40x1.5	Izquierda/Left/Gauche	4x3	2.5x12	
23/8026	60x1.5	Izquierda/Left/Gauche	4x4	3x16	
23/8027	80x1.5	Izquierda/Left/Gauche	4x4	3x16	
23/8037	40x1.5	Derecha/Right/Droite	4x3	2.5x12	
23/8038	60x1.5	Derecha/Right/Droite	4x4	3x16	
23/8039	80x1.5	Derecha/Right/Droite	4x4	3x16	

Materiales- (Acabados) / Materials- (Treatments) / Matériaux- (Finitions)

H (NI) - (BRI)

L (PU) - (NI)



Aldabas valencianas - Fastener - Fermeture

Ref.47



Ref./Cod.	mm Medidas Size Dimension	Agujeros x ømm Holes Trou	Ø Tornillo Screw Vis	
47/8053	50x12x2	1x4.5	3.5x20	
47/8055	60x12x2	1x4.5	3.5x20	
47/8057	70x12x2	1x4.5	3.5x20	

Materiales- (Acabados) / Materials- (Treatments) / Matériaux- (Finitions)

H (ZI)



Bis sostenedor - Support for fastener - Support pour fermeture

Ref.47

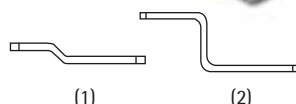

Ref./Cod.	mm Medidas Size Dimension	Denominación Name Dénomination	Agujeros x ømm Holes Trou	Ø Tornillo Screw Vis	
47/8049 (1)	46x12x2x8	Plana/Punche/Plate	2x4	3x16	
47/8052 (2)	49x12x2x17	Tapabocas/Tompion/Bouchon	2x4	3x16	

Materiales- (Acabados) / Materials- (Treatments) / Matériaux- (Finitions)

H (ZI)



Ref.464

Imán Simple 4 kgs - Magnet 4 kgs - Aimant 4 kgs

Ref./Cod.	mm Medidas Size Dimension	Agujeros x ømm Holes Trou	Ø Tornillo Screw Vis
464/3006	45x15x14		

Materiales- (Acabados) / Materials- (Treatments) / Matériaux- (Finitions)

PLAS (BL) - (MR) - (NG)



Ref.464

Imán Doble 8 kgs - Double Magnet 8 kgs - Aimant double 8 kgs

Ref./Cod.	mm Medidas Size Dimension	Agujeros x ømm Holes Trou	Ø Tornillo Screw Vis
464/4110	95x20x14		

Materiales- (Acabados) / Materials- (Treatments) / Matériaux- (Finitions)

PLAS (BL) - (MR) - (NG)



Ref.464

Imán Grande 12 kgs - Big Magnet 12 kgs - Grand Aimant 12 kgs

Ref./Cod.	mm Medidas Size Dimension	Agujeros x ømm Holes Trou	Ø Tornillo Screw Vis
464/4111	57x25x15		

Materiales- (Acabados) / Materials- (Treatments) / Matériaux- (Finitions)

PLAS (BL) - (MR) - (NG)



Golpetes bola - *Roller catch* - Loqueteau à pène

Ref.464



Ref./Cod.	mm Medidas Size Dimension	Agujeros x ømm Holes Trou	Ø Tornillo Screw Vis
464/1970	40x8	2x4	3.5x16
464/1971	50x9	2x4	3.5x16
464/1972	60x11	2x4.5	4x20
464/1973	70x13	2x4.5	4x20

Materiales- (Acabados) / Materials- (Treatments) / Matériaux- (Finitions)

L (PU) - (NI)



Golpetes presión - *Roller catch* - Loqueteau à pène

Ref.464



Ref./Cod.	mm Medidas Size Dimension	Agujeros x ømm Holes Trou	Ø Tornillo Screw Vis
464/4157	60x13		

Materiales- (Acabados) / Materials- (Treatments) / Matériaux- (Finitions)

Z (LA) - (NI) - (BR)



Golpetes presión - *Roller catch* - Loqueteau à pène

Ref.464



Ref./Cod.	mm Medidas Size Dimension	Agujeros x ømm Holes Trou	Ø Tornillo Screw Vis
464/2760	25x1		

Materiales- (Acabados) / Materials- (Treatments) / Matériaux- (Finitions)

H (ZI) - (BRI) - (BR)



Ref./Cod.	mm Medidas Size Dimension
619/4145	41x17



Materiales- (Acabados) / Materials- (Treatments) / Matériaux- (Finitions)	
PLAS	(BL) - (NG)



Ref./Cod.	mm Medidas Size Dimension	
622/2993	10x15x85	Con imán / <i>With magnet</i> / Avec magnétique
622/4380	10x15x85	Sin imán / <i>Without magnet</i> / Sans magnétique



Con regulación y recorrido de 40mm

Materiales- (Acabados) / Materials- (Treatments) / Matériaux- (Finitions)	
PLAS	(BL) - (MR) - (GR)



Ref./Cod.	mm Medidas Size Dimension
622/4155	55x45



Materiales- (Acabados) / Materials- (Treatments) / Matériaux- (Finitions)	
PLAS	(BL) - (GR)



Tarabillas - Rotary catch - Papillons simples

Ref.597



Ref./Cod.	mm Medidas Size Dimension
597/4224	40x12x8

Materiales- (Acabados) / Materials- (Treatments) / Matériaux- (Finitions)

Z (PU) - (LA) - (NI) - (CO)



Dedales - Dust proof strikes - Gâches sol anti-poussiere

Ref.400



Ref./Cod.	mm Medidas / Size / Dimension	
	D	E
400/2026	∅ 9	∅ 13
400/2027	∅ 11	∅ 15
400/2028	∅ 13	∅ 17
400/2029	∅ 15	∅ 19
400/2030	∅ 20	∅ 25
400/2031	∅ 23	∅ 28

Materiales- (Acabados) / Materials- (Treatments) / Matériaux- (Finitions)

L (B) - (NI)



Características/ Characteristics/ Caractéristiques

Casquillo embellecedor con tapa antisuciedad o polvo. Se embute en el suelo.
Para el cierre de pasadores, pestillos, cerraduras, etc.

Most often used on installed on the door threshold for a surface mounted or flush bolt, to prevent the accumulation of debris in the bolt strike hole. This dust proof socket adds more security to door bolts.

Gâche à encastrer au sol. La fonction anti-poussière permet d'éviter l'obstruction pour des corps étrangers (cailloux, poussières ...) et permet ainsi de garantir la fermeture des verrous ou des crémones.



Ref.356

Topes para puerta - *Door stoppers* - Bouchons de porte

Ref./Cod.	mm Medidas Size Dimension
356/1591	Ø45

Materiales- (Acabados) / Materials- (Treatments) / Matériaux- (Finitions)	
I303	(SA)



Ref.356

Topes para puerta - *Door stoppers* - Bouchons de porte

Ref./Cod.	mm Medidas Size Dimension
356/1614	Ø30x38

Materiales- (Acabados) / Materials- (Treatments) / Matériaux- (Finitions)	
I303	(SA)



Ref.356

Topes para puerta - *Door stoppers* - Bouchons de porte

Ref./Cod.	mm Medidas Size Dimension
356/1619	Ø35x35

Materiales- (Acabados) / Materials- (Treatments) / Matériaux- (Finitions)	
I303	(SA)



Ref.356

Topes para puerta - *Door stoppers* - Bouchons de porte

Ref./Cod.	mm Medidas Size Dimension
356/2448	Ø45x40

Materiales- (Acabados) / Materials- (Treatments) / Matériaux- (Finitions)	
I303	(SA)



BISAGRAS, PERNIOS Y ACCESORIOS PARA CARPINTERÍA METÁLICA

HINGES AND ACCESSORIES FOR PROFILES

CHARNIÈRES ET ACCESSOIRES POUR PROFILS

PAG.132-135



Ref./Cod.	mm Medidas Size Dimension	Agujeros / Holes / Trou Un. x ø mm	Ø Tornillo Screw Vis
356/1153	95x83x3	4x7	4.5x25
356/1940	95x90x3	4x7	4.5x25
356/1347	95x83x3 Con muelle/spring/ressort	4x7	4.5x25
356/4277	95x90x3 Con muelle/spring/ressort	4x7	4.5x25
457/1687	95x3	2x11	M10
149/247	100x77x3	4x5	4.5x25
149/4239	100x77x3	4.5	4.5x25
356/1231	20x83.5x2	RECIBIDOR / FIXED ELEMENT / PARTIE FIXE FERMOIR	

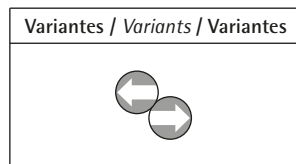

Materiales- (Acabados) / Materials- (Treatments) / Matériaux- (Finitions)

- H** (PU) - (ZI)
- I304** (B) - (SA)

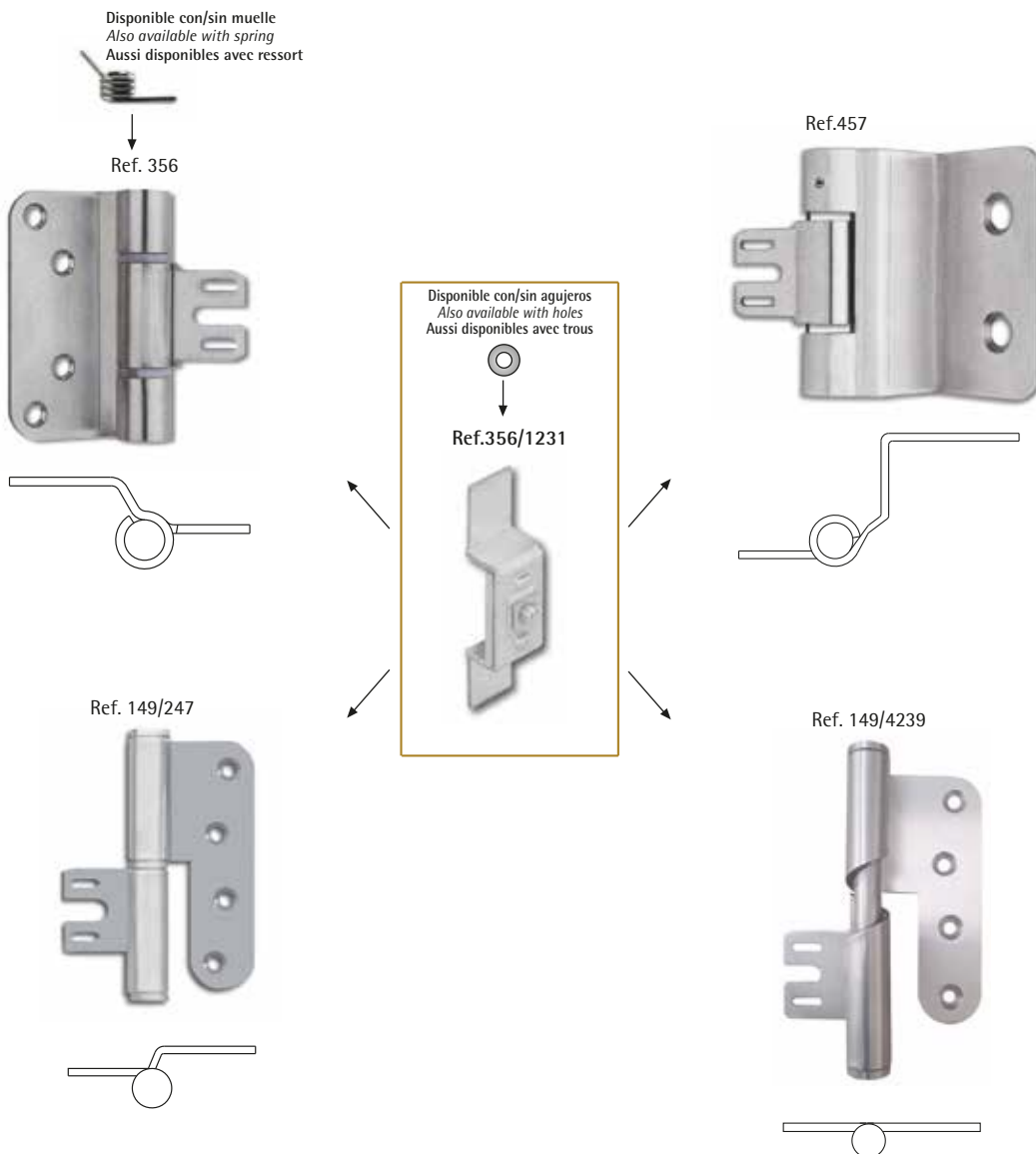

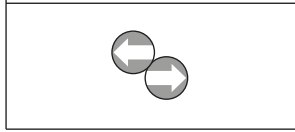
Variantes / *Variants* / Variantes

Ref./Cod.	mm Medidas Size Dimension	Agujeros x ømm Holes Trou	Ø Tornillo Screw Vis
156/254	76x76x3	3x5.5	4.5x25
		3xM5	M5

Materiales- (Acabados) /
Materials- (Treatments) /
Matériaux- (Finitions)

1304 (SA)

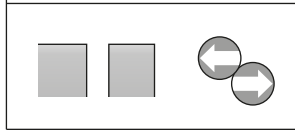
Variantes / *Variants* / Variantes

Ref./Cod.	mm Medidas Size Dimension	Agujeros x ømm Holes Trou	Ø Tornillo Screw Vis
150/248	100x77x3	4x5	4.5x25
		○ 6.5x15	
151/249	100x88x2,5	4x6	4.5x25
		○ 6x43	

Materiales- (Acabados) / *Materials- (Treatments) /* Matériaux- (Finitions)

H (PU) - (ZI)

1304 (SA)

Ref. 150



Ref. 151

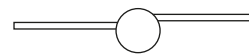

Conjunto escuadras planas con tornillos - Flat brackets kit - Kit d'équerres plates

Ref.356



Ref./Cod.	mm Medidas Size Dimension
356/1281	60x60x2
356/1148	70x70x2
356/1183	70x70x4

Materiales- (Acabados) / Materials- (Treatments) / Matériaux- (Finitions)

H (Zl)



356/1281



356/1183



356/1148

Escuadra con tornillos - Bracket with screws - Équerre avec vis

Ref.356



Vista delantera

Vista trasera

Ref./Cod.	mm Medidas Size Dimension
356/1141	40x40x18x3
356/1140	40x40x18x4

Materiales- (Acabados) / Materials- (Treatments) / Matériaux- (Finitions)

H (Zl)



Cuadradillo con rosca M5 - M5 screw metallic plate - Plaque fileté M5

Ref.356



Ref./Cod.	mm Medidas Size Dimension
356/1145	18x18x3

Materiales- (Acabados) / Materials- (Treatments) / Matériaux- (Finitions)

H (Zl)



Ref.356

Pletina cerco - *Metallic plate - Plaque*

Ref./Cod.	mm Medidas Size Dimension
356/1146	40x100x4
356/2245	40x150x4

Materiales- (Acabados) / *Materials- (Treatments) / Matériaux- (Finitions)*

H (ZI)



Ref.432

Escuadra - *Bracket - Équerre*

Ref./Cod.	mm Medidas Size Dimension
432/2961	37x46+22x3
432/2962	38x50+22x3

Materiales- (Acabados) / *Materials- (Treatments) / Matériaux- (Finitions)*

H (ZI)



Ref.432

Escuadra para paneles - *Bracket - Équerre*

Ref./Cod.	mm Medidas Size Dimension
432/2964	38x70+46x5
432/2963	38x70+49x5

Materiales- (Acabados) / *Materials- (Treatments) / Matériaux- (Finitions)*

H (ZI)



Ref.356

Escuadra para paneles - *Bracket - Équerre*

Ref./Cod.	mm Medidas Size Dimension
356/1793	80x80x2.7
356/1794	150x80x2.7

Materiales- (Acabados) / *Materials- (Treatments) / Matériaux- (Finitions)*

H (ZI)



ESCUADRAS ESTANTERÍA / *SHELF BRACKETS* / CONSOLE ET ÉQUERRES *PAG.138-141*

ESCUADRAS UNIÓN / *BRACKETS* / ÉQUERRES *PAG.142-145*

PLACAS UNIÓN / *CONNECTOR PLATES* / PLAQUES D'ASSEMBLAGE *PAG.145-147*

SOPORTES Y ENSAMBLAJES / *SUPPORTS AND CONNECTORS* / SUPPORTS ET ANCRAGES *PAG.148-151*

CIERRES LEVA PARA CAJA / *TOGGLE LATCHES* / FERMETURES À GRENOUILLIÈRE *PAG.152-153*

ACCESORIOS TUBO ROPERO / *WARDROBE RAIL SUPPORTS* / SUPPORTS DE BARRE DE PENDERIE *PAG.154-155*



Escuadras estantería abatibles - *Folding shelf brackets* - Équerre console rabattable

Ref.700



Ref./Cod.	mm Medidas Size Dimension	Posiciones Positions Positions
700/2005	200x200	1
700/2006	300x200	1
700/2007	300x300	1
700/2008	300x300	3
700/2009	400x300	1
700/2010	400x400	1
700/2011	400x400	3

Características/ *Characteristics*/ Caractéristiques

Elemento de alta resistencia. Ideal para tres casos en el mismo plano de trabajo.
High quality item. Ideal for use as a set three along one working surface.
 Éléments de haute résistance. Idéal pour trois cas sur le même plan de travail.

Materiales- (Acabados) / *Materials- (Treatments)* / Matériaux- (Finitions)

H (CR) - (PIBL) - (PING)

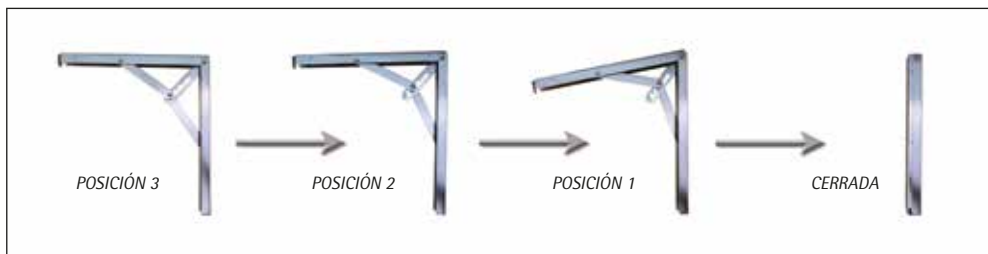

Escuadra estantería plegable - *Folding shelf bracket* - Équerre console pliante

Ref.608



Ref./Cod.	mm Medidas Size Dimension
608/3026	200x200
608/3025	300x300
608/3024	400x400

Materiales- (Acabados) / *Materials- (Treatments)* / Matériaux- (Finitions)

H (ZI) - (PIBL)



Ref.607

Escuadra estantería reforzada - *Heavy duty shelf bracket* - Équerre console lourde charge

Ref./Cod.	mm Medidas Size Dimension
607/3012	150x125
607/3013	200x150
607/3014	250x200
607/3015	300x200
607/3016	400x270
607/3017	500x330

Materiales- (Acabados) / *Materials- (Treatments)* / Matériaux- (Finitions)

 (PIBL) - (PIGR)



10 u.



Ref.612

Escuadra estantería - *Shelf bracket* - Équerre console

Ref./Cod.	mm Medidas Size Dimension
612/4028	100x75
612/4029	125x100
612/4030	150x125
612/4031	200x150
612/4032	250x200
612/4119	300x250
612/4295	350x300

Materiales- (Acabados) / *Materials- (Treatments)* / Matériaux- (Finitions)

 (PIBL) - (PIGR) - (PING)



12 u.



Ref.626

Escuadra palomilla estantería - *Shelf bracket* - Équerre console emboutie

Ref./Cod.	mm Medidas Size Dimension
626/4033	100x75
626/4034	125x100
626/4035	150x125
626/4036	200x150
626/4037	250x200
626/4038	300x250
626/4039	350x300
626/4040	400x350
626/4041	450x400

Materiales- (Acabados) / *Materials- (Treatments)* / Matériaux- (Finitions)

 (PIBL) - (PIGR)



20 u.



Escuadra estantería de aluminio - *Aluminium shelf bracket* - Équerre console en aluminium Ref.611



Ref./Cod.	mm Medidas Size Dimension
611/4177	100x65
611/4178	150x100
611/4179	200x150
611/4180	250x200
611/4181	300x200

Materiales- (Acabados) / *Materials- (Treatments)* / *Matériaux- (Finitions)*

AL (PIBL) - (PIMR) - (PING)



Escuadra estantería ornamental - *Ornamental shelf bracket* - Équerre console en fer forge Ref.624



Ref./Cod.	mm Medidas Size Dimension
624/4168	100x75
624/4169	150x115
624/4170	200x150
624/4171	250x200

Materiales- (Acabados) / *Materials- (Treatments)* / *Matériaux- (Finitions)*

H (PING)



Conjunto escuadras en perfil ángulo - *Set shelf brackets set* - Kit équerres console Ref.609



Ref./Cod.	mm Medidas Size Dimension
609/4182	400x300
609/4183	500x300

Se sirven las cajas con un conjunto de 1 escuadra derecha + 1 escuadra izquierda
The set contains 1 piece right + 1 piece left
 Il contient 1 pièce droite + 1 pièce gauche

Materiales- (Acabados) / *Materials- (Treatments)* / *Matériaux- (Finitions)*

H (PIBL)



Ref.613

Escuadra reforzada - Heavy duty bracket - Équerre lourde charge

Ref./Cod.	mm Medidas Size Dimension
613/4192	30x30
613/3020	50x50
613/3021	75x75
613/3022	100x100



Materiales- (Acabados) / Materials- (Treatments) / Matériaux- (Finitions)

H (ZI) - (PIBL) - (PING)



Ref.653 **Soporte estantería "Pelicano" - Adjustable shelf supports - Équerre console "Toucan"**

Ref./Cod.	mm Medidas Size Dimension
653/4289	60x97x18



Características/ Characteristics/ Caractéristiques

Para tableros/cristales de entre 8 y 28 mm
For wood/glass thickness between 8 and 28 mm
Pour verre d'épaisseur 8/28mm



Materiales- (Acabados) / Materials- (Treatments) / Matériaux- (Finitions)

Z (CR)

Escuadras en canto romo - Brackets with round corners - Équerres

Ref.72



Ref./Cod.	mm Medidas Size Dimension	Agujeros x ømm Holes Trou	ø Tornillo Screw Vis
72/10037	20x20x20x1.5	2x4	3.5x20
72/10038	30x30x20x1.5	4x4	3.5x20
72/10039	40x40x20x2	4x4	3.5x20
72/10040	50x50x20x2	4x4	3.5x20
72/10041	60x60x20x2	4x4	3.5x20
72/10042	80x80x20x2	6x4	3.5x20
72/10043	100x100x20x2	6x4	3.5x20
72/2330	120x120x20x2	8x5	4x25

Materiales- (Acabados) / Materials- (Treatments) / Matériaux- (Finitions)

H (BRI)



Se puede fabricar en diferentes ángulos / We can produce different angles / Il est fait d'angles différents

Escuadras en canto vivo - 90° brackets - Équerre avec bouts carrés

Ref.31



Ref./Cod.	mm Medidas Size Dimension	Agujeros x ømm Holes Trou	ø Tornillo Screw Vis
31/10046	20x20x20x1.5	2x4	3.5x20
31/10047	30x30x20x1.5	4x4	3.5x20
31/10048	40x40x20x2	4x4	3.5x20
31/10049	50x50x20x2	4x4	3.5x20
31/10050	60x60x20x2	4x4	3.5x20
31/10051	70x70x20x2	6x4	3.5x20
31/10052	80x80x20x2	6x4	3.5x20
31/10053	100x100x20x2	6x4	3.5x20
31/10054	120x120x20x2	6x4	3.5x20

Materiales- (Acabados) / Materials- (Treatments) / Matériaux- (Finitions)

H (PU) - (ZI)

I304 (B)



Ref.217

Escuadras - 90° fixed brackets - Équerres

Ref./Cod.	mm Medidas Size Dimension	Agujeros x ømm Holes Trou	Ø Tornillo Screw Vis
217/332	20x20x13x2	2x5	3.5x20
217/333	30x30x13x2	2x5	3.5x20
217/334	40x40x13x2	2x5	3.5x20



Materiales- (Acabados) / Materials- (Treatments) / Matériaux- (Finitions)

1304 (B)

Ref.1010

Escuadras reforzadas - Heavy duty 90° brackets - Équerres

Ref./Cod.	mm Medidas Size Dimension	Agujeros x ømm Holes Trou	Ø Tornillo Screw Vis
1010/7507	70x40+40x3	4xø4 / 2xø8	3.5x20



Materiales- (Acabados) / Materials- (Treatments) / Matériaux- (Finitions)

H (NI)

Ref.432

Escuadra con coliso - 90° brackets - Équerres

Ref./Cod.	mm Medidas Size Dimension	Agujeros x ømm Holes Trou	Ø Tornillo Screw Vis
432/1644	30x2.5x38+21	2x5	4x25
432/2387	42x2x35+35	3x4	3x20



Materiales- (Acabados) / Materials- (Treatments) / Matériaux- (Finitions)

H (ZI)

Escuadras planas - Flat angle brackets - Équerres plate

Ref.30



Ref./Cod.	mm Medidas Size Dimension	Agujeros x ømm Holes Trou	Ø Tornillo Screw Vis
30/10004	30x30x13x1	4x4	3.5x16
30/10006	40x40x13x1	4x4	3.5x16
30/10008	60x60x17x1	4x4	3.5x16
30/10010	80x80x19x1.5	6x4	3.5x16
30/10012	100x100x20x1.5	6x4	3.5x16
30/10014	120x120x20x1.5	6x4	3.5x16



Materiales- (Acabados) / Materials- (Treatments) / Matériaux- (Finitions)

H (ZI) - (BRI)

Escuadras cama - Bed supports - Supports de lit

Ref.71



Ref./Cod.	mm Medidas Size Dimension	Agujeros x ømm Holes Trou	Ø Tornillo Screw Vis
71/10036	35x3x45	3x4.5	4x25
71/2695	35x3x75	3x4.5	4x25

Materiales- (Acabados) / Materials- (Treatments) / Matériaux- (Finitions)

H (ZI)



Soportes cama - Bed supports - Supports de lit

Ref.3000



Ref./Cod.	mm Medidas Size Dimension	Agujeros x ømm Holes Trou	Ø Tornillo Screw Vis
3000/2066	40x80x23	8x5	3,5x20

Materiales- (Acabados) / Materials- (Treatments) / Matériaux- (Finitions)

H (PA) - (ZI)



Ref.440

Escuadra de unión canto romo - *Brackets - Équerres*

Ref./Cod.	mm Medidas Size Dimension	Variantes Options Variantes
440/1744	50x50x3	

Materiales- (Acabados) / *Materials- (Treatments) / Matériaux- (Finitions)*

I304 (SA)

I316 (SA)



Ref.440

Escuadra de unión - *Brackets - Équerres*

Ref./Cod.	mm Medidas Size Dimension	Variantes Options Variantes
440/4594	50x50x2	Con 2 embuticiones de refuerzo

Materiales- (Acabados) / *Materials- (Treatments) / Matériaux- (Finitions)*

I304 (SA)

I316 (SA)



Ref.440

Placa doble unión tableros - *Connecting plates kit - Plaque de connexion*

Ref./Cod.	mm Medidas Size Dimension	mm Medida tablero	Variantes Options Variantes
440/2589	50x67x2		

Materiales- (Acabados) / *Materials- (Treatments) / Matériaux- (Finitions)*

I304 (SA)

I316 (SA)



Ref.440

Pinza sujeta-cristales - *Glass support - Pince à verre*

Ref./Cod.	mm Medidas Size Dimension	mm Medida cristal Glass size Dimension de verre	Variantes Options Variantes
440/1802	40x50x10	Entre 8/10mm	Para tubo Ø43

Materiales- (Acabados) / *Materials- (Treatments) / Matériaux- (Finitions)*

I316 (PUE)



Placas unión con refuerzo - *Heavy duty connecting plate* - Plaque de connexion renforcé

Ref.1000

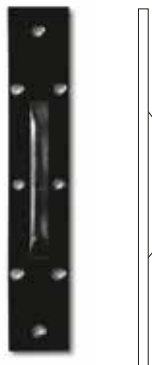

Ref./Cod.	mm Medidas Size Dimension	Agujeros x ømm Holes Trou	Ø Tornillo Screw Vis
1000/7500	30x170x3	8x4.5	3.5x20

Materiales- (Acabados) / Materials- (Treatments) / Matériaux- (Finitions)

H (BRI) - (PA)



Placa unión plana cantos romos - *Connecting plate* - Plaque de connexion

Ref.73



Ref./Cod.	mm Medidas Size Dimension	Agujeros x ømm Holes Trou	Ø Tornillo Screw Vis
73/1505	40x20x1.5	2x4	3.5x20
73/1506	60x20x1.5	4x4	3.5x20
73/1507	80x20x2	4x4	3.5x20
73/1508	100x20x2	4x4	3.5x20
73/1509	120x20x2	6x4	3.5x20
73/1511	160x20x2	6x4	3.5x20
73/1510	200x20x2	6x4	3.5x20

Materiales- (Acabados) / Materials- (Treatments) / Matériaux- (Finitions)

H (BRI)



Placa unión plana cantos romos - *Connecting plate* - Plaque de connexion

Ref.211



Ref./Cod.	mm Medidas Size Dimension	Agujeros x ømm Holes Trou	Ø Tornillo Screw Vis
211/326	75x16x3	3x5.5	4.5x25

Materiales- (Acabados) / Materials- (Treatments) / Matériaux- (Finitions)

H (PU) - (ZI) - (BR)



Ref./Cod.	mm Medidas Size Dimension	Agujeros x ømm Holes Trou	Ø Tornillo Screw Vis
212/327	70x15x3	2x7	5x25

Materiales- (Acabados) / Materials- (Treatments) / Matériaux- (Finitions)

H (PU) - (ZI) - (BR)



Ref.219 Placa roscada para perfiles - Plate with metric holes - Plaque avec filetage métrique

Ref./Cod.	mm Medidas Size / Dimension A x B x C	Agujeros Holes Trou	F
219/1212	18 x 8 x 3	1xM4	-
219/1211	20 x 10 x 3	1xM4	-
219/4813	50 x 17 x 3	2xM5	29,5
219/1210	55 x 7,5 x 3	2xM4	37
219/723	58 x 8,5 x 3	2xM5	40
219/336	58 x 8,5 x 3	2xM5	42,5
219/4814	58 x 14 x 3	2xM4	40
219/1070	58 x 14 x 3	2xM5	40
219/4780	60 x 7 x 3	3xM4	40
219/2814	60 x 8,5 x 3	2xM4	45
219/4815	60 x 9 x 3	3xM4	42
219/4521	60 x 15 x 3	2xM5	39

Materiales- (Acabados) / Materials- (Treatments) / Matériaux- (Finitions)

I304 (B)

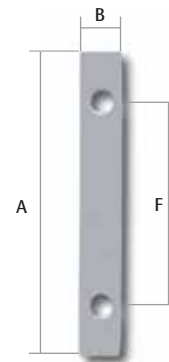

Ref.213 Placa cuadrada roscada M5 - Square plate with M5 center hole - Plaque fileté M5

Ref./Cod.	mm Medidas Size Dimension	Agujeros x ømm Holes Trou	Ø Tornillo Screw Vis
213/328	50x43x4	4x5 / 1xM5	4.5x25

Materiales- (Acabados) / Materials- (Treatments) / Matériaux- (Finitions)

H (PU) - (ZI) - (BR)



Soporte tablero - Board support - Supports panneaux

Ref.222



Ref./Cod.	mm Medidas Size Dimension	Agujeros x ømm Holes Trou	Ø Tornillo Screw Vis
222/339	30x15x2		

Materiales- (Acabados) / Materials- (Treatments) / Matériaux- (Finitions)

H (LA) - (ZI)



Soporte tablero - Board support - Supports panneaux

Ref.223



Ref./Cod.	mm Medidas Size Dimension	Agujeros x ømm Holes Trou	Ø Tornillo Screw Vis
223/340	63x15x18x2	4x3	2.5x12

Materiales- (Acabados) / Materials- (Treatments) / Matériaux- (Finitions)

H (LA) - (ZI)



Soporte tablero - Board support - Supports panneaux

Ref.224



Ref./Cod.	mm Medidas Size Dimension	Agujeros x ømm Holes Trou	Ø Tornillo Screw Vis
224/341	40x15x14x2	2x3	2.5x12

Materiales- (Acabados) / Materials- (Treatments) / Matériaux- (Finitions)

H (LA) - (ZI)



Soporte tablero - Board support - Supports panneaux

Ref.221

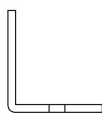
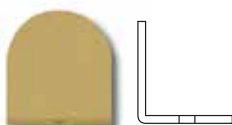

Ref./Cod.	mm Medidas Size Dimension	Agujeros x ømm Holes Trou	Ø Tornillo Screw Vis
221/337	15mm	1x6	4.5x25

Materiales- (Acabados) / Materials- (Treatments) / Matériaux- (Finitions)

H (LA)

L (PU)



Soporte tablero - Board support - Supports panneaux

Ref.221

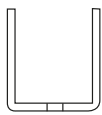
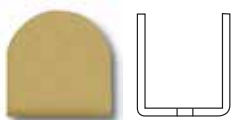

Ref./Cod.	mm Medidas Size Dimension	Agujeros x ømm Holes Trou	Ø Tornillo Screw Vis
221/338	15mm	1x6	4.5x25

Materiales- (Acabados) / Materials- (Treatments) / Matériaux- (Finitions)

H (LA)

L (PU)



Ref./Cod.	mm Medidas Size Dimension
93/7503	20x14x1.5

Materiales- (Acabados) / Materials- (Treatments) / Matériaux- (Finitions)	
H	(LA) - (ZI) - (BRI)



1000 u.



Ref.342 Juego ensamblajes con tornillos - Kit assembly with screw - Ensemble de fixation

Ref./Cod.	mm Medidas Size Dimension	Agujeros x ømm Holes Trou	Ø Tornillo Screw Vis
342/1069	41x17x2	2x4	3x20
342/2336	70x22x2	2x5	3,5x20

Materiales- (Acabados) / Materials- (Treatments) / Matériaux- (Finitions)	
H	(ZI)
I304	(B)



25 u.



Ref. 342

Juego ensamblajes escuadra - Kit assembly - Ensemble de fixation

Ref./Cod.	mm Medidas Size Dimension	G
342/4696	70x1,5	65°
342/4786	70x1,5	90°

Materiales- (Acabados) / Materials- (Treatments) / Matériaux- (Finitions)	
H	(ZI) - (BRI)



25 u.

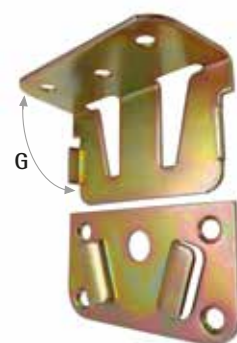

Tensores caja con tornillo allen M6 - Turnbuckle strainer - Tendeur

Ref.20



Ref./Cod.	mm Medidas Size Dimension	Agujeros x ømm Holes Trou	Ø Tornillo Screw Vis
20/5004	36x19x13x1	2x4	3x16

Materiales- (Acabados) / Materials- (Treatments) / Matériaux- (Finitions)

H (BRI)



Cantoneras - Corner pieces - Coins de caisse

Ref.215-216



Ref. 215 cantonera normal /
normal corner piece /
cornière normale

Ref./Cod.	mm Medidas Size Dimension	Agujeros x ømm Holes Trou	Ø Tornillo Screw Vis
215/330	27x27x27	3x5	3.5x20
216/331	27x27x27	2x5	3.5x20

Materiales- (Acabados) / Materials- (Treatments) / Matériaux- (Finitions)

H (NI) - (CR)



Ref. 216 cantonera pata /
legged-corner piece /
cornière tige



Grapa para tarima - Fixing holes plate - Gache crampon

Ref.264

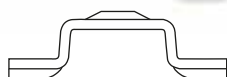

Ref./Cod.	mm Medidas/Size Dimension H x L x C	E
264/1999	23x27x1.2	13
264/1289	23x33x1.5	18
264/2610	23x40x1.5	18
264/1161	40x33x1.5	13

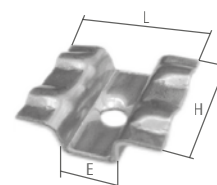

Materiales- (Acabados) / Materials- (Treatments) / Matériaux- (Finitions)

I304 (B)



Ref./Cod.	mm Medidas Size Dimension	Medida bola Ball size Diamètre de la balle
761/4787	70x70x10x0.6	Ø6
761/4758	70x70x10x0.6	Ø8
761/4759	70x70x10x0.6	Ø10

Para medidas especiales, consultar.
Consult for special sizes.
Pour des dimensions spéciales, consulter.



100 u.

Materiales- (Acabados) / Materials- (Treatments) / Matériaux- (Finitions)

H (F-141)

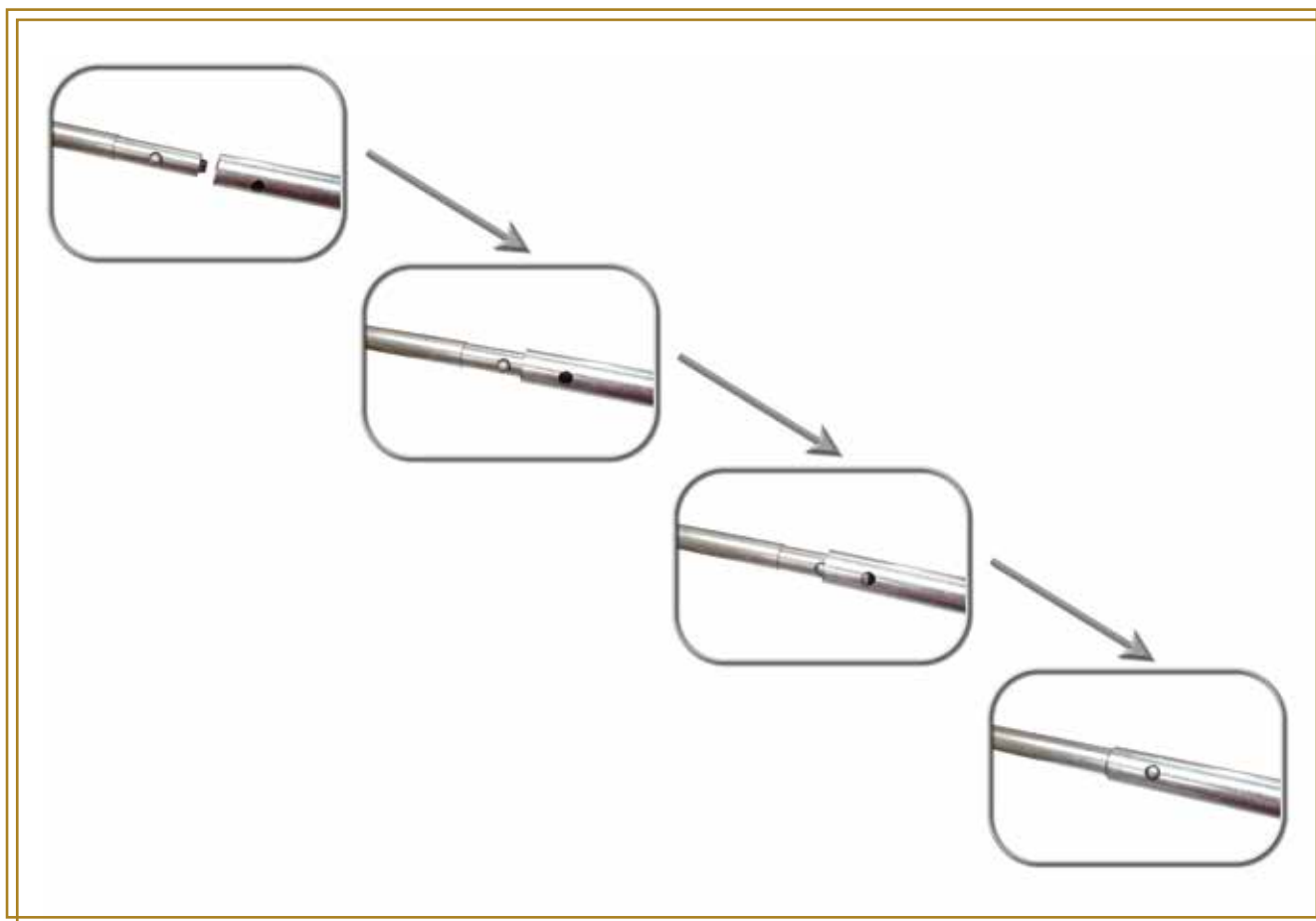

Cierre de leva pequeño - *Toggle latch light duty* - Fermeture à grenouillière

Ref.754

754/4733



754/4734



Ref./Cod.	mm Medidas Size Dimension	Variante Options Variantes
754/4733	60x16,4	
754/4734	60x16,4	Con portacandado

Materiales- (Acabados) / Materials- (Treatments) / Matériaux- (Finitions)

 (ZI)



Cierre de leva mediano - *Toggle latch medium duty* - Fermeture à grenouillière

Ref.754

754/4731



754/4732



Ref./Cod.	mm Medidas Size Dimension	Variante Options Variantes
754/4731	86x23	
754/4732	86x23	Con portacandado

Materiales- (Acabados) / Materials- (Treatments) / Matériaux- (Finitions)

 (ZI)



Cierre de leva grande - *Toggle latch heavy duty* - Fermeture à grenouillière

Ref.754

754/4729



754/4730



Ref./Cod.	mm Medidas Size Dimension	Variante Options Variantes
754/4729	112x30	
754/4730	112x30	Con portacandado

Materiales- (Acabados) / Materials- (Treatments) / Matériaux- (Finitions)

 (ZI)



Ref.754

Cierre de leva reducido - *Toggle latch light duty* - Fermeture à grenouillère

Ref./Cod.	mm Medidas Size Dimension	Variante Options Variantes
754/4736	34x15	
754/4737	34x15	Con portacandado

754/4736



754/4737



25 u.

Materiales- (Acabados) / Materials- (Treatments) / Matériaux- (Finitions)

 H (Zl)

Ref.754

Cierre de leva maneta curvada - *Toggle latch* - Fermeture à grenouillère

Ref./Cod.	mm Medidas Size Dimension	Variante Options Variantes
754/4735	47x15	

754/4735



25 u.

Materiales- (Acabados) / Materials- (Treatments) / Matériaux- (Finitions)

 H (Zl)

Ref.754

Cierre de leva regulable - *Adjustable toggle latch* - Fermeture à grenouillère réglable

Ref./Cod.	mm Medidas Size Dimension	Variante Options Variantes
754/4738	68	
754/4739	68	Con portacandado

754/4738



25 u.

Materiales- (Acabados) / Materials- (Treatments) / Matériaux- (Finitions)

 H (Zl)

Soporte barra armario redondo - *Wardrobe rail support* - Support de barre de penderie

Ref.636



Ref./Cod.	mm Medidas Size Dimension
636/4258	Ø16
636/4259	Ø19
636/4260	Ø25

Variantes / *Variants* / *Variantes*



Materiales- (Acabados) / *Materials- (Treatments)* / *Matériaux- (Finitions)*

Z (LA) - (NI) - (PIBL)



Soporte barra armario ovalada - *Wardrobe rail support* - Support de barre de penderie

Ref.636



Ref./Cod.	mm Medidas Size Dimension
636/4257	30x16

Variantes / *Variants* / *Variantes*



Materiales- (Acabados) / *Materials- (Treatments)* / *Matériaux- (Finitions)*

Z (LA) - (NI) - (PIBL)



Soporte barra armario lateral - *Wardrobe rail support* - Support de barre de penderie

Ref./Cod.	mm Medidas Size Dimension
636/4288	15



Materiales- (Acabados) / Materials- (Treatments) / Matériaux- (Finitions)

Z (LA) - (NI) - (PIBL)



50 u.

Soporte barra armario lateral - *Wardrobe rail support* - Support de barre de penderie

Ref./Cod.	mm Medidas Size Dimension	Agujeros x ømm Holes Trou	Ø Tornillo Screw Vis 
92/4513	16x0.8	1x6 / 1x4.5	4.5x25
92/4515	20x1.2	1x6 / 1x5	4.5x25



Materiales- (Acabados) / Materials- (Treatments) / Matériaux- (Finitions)

H (LA) - (NI)



100 u.

PLACAS COLGADOR/GANCHOS / *HOOKS/HOOK PLATES / PLAQUES PENDERIE/CROCHETS* PAG.158-160

PERCHAS / *HANGERS / PATÈRES* PAG.161-163

ASAS / *SHANDLES / POIGNÉES* PAG.164-165



Placas cartela - Connecting plate - Attache plaque

Ref.50



Ref./Cod.	mm Medidas Size Dimension	Agujeros x ømm Holes Trou	Ø Tornillo Screw Vis
50/1501	40x15x1	2x3.5	3x16
50/1502	50x16x1.2	2x3.5	3x16
50/1503	60x18x1.2	2x3.5	3x16

Materiales- (Acabados) / Materials- (Treatments) / Matériaux- (Finitions)

H (Zl)



Soportes para armario metálico - Hanger plates - Support pour cabinet

Ref.490

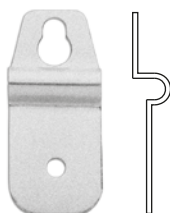

Ref./Cod.	mm Medidas Size Dimension	Agujeros x ømm Holes Trou	Ø Tornillo Screw Vis
490/2225	85x30x2	1x7	-

Materiales- (Acabados) / Materials- (Treatments) / Matériaux- (Finitions)

H (Zl)



Placas gancho - Hook plates - Crochets

Ref.469



Ref./Cod.	mm Medidas Size Dimension	Agujeros x ømm Holes Trou	Ø Tornillo Screw Vis
469/1989	62.5x22x2.5	2x5	4x25

Materiales- (Acabados) / Materials- (Treatments) / Matériaux- (Finitions)

H (Zl)



Placas gancho - Hook plates - Crochets

Ref.357



Ref./Cod.	mm Medidas Size Dimension	Agujeros x ømm Holes Trou	Ø Tornillo Screw Vis
357/1154	75x20x2	2x6	4.5x25

Materiales- (Acabados) / Materials- (Treatments) / Matériaux- (Finitions)

B316 (B)



Ref.74 Placas colgar armarios - *Hanger plates for cupboard* - Équerre triangulaire pour armoire

Ref./Cod.	mm Medidas Size / Dimension A x B x C x H x T	Agujeros x ømm Holes Trou	Ø Tornillo Screw Vis
74/1405	69x69x0.8x90x56	5x3.5	3.5x20
74/4774	69x69x0.8x90x54	5x3.5	3.5x20
74/4311	66x66x0.7x88x35	4x3.5	3.5x20

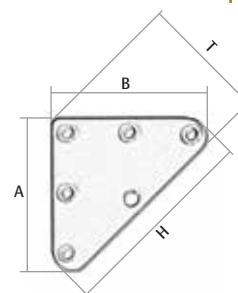

Materiales- (Acabados) / Materials- (Treatments) / Matériaux- (Finitions)
H (BRI)



74/1405



74/4774



74/4311

Ref.80

Placas colgador - *Hanger plates* - Plaques penderie

Ref./Cod.	mm Medidas Size Dimension	Agujeros x ømm Holes Trou	Ø Tornillo Screw Vis
80/1513	40x17x0.8	2x3.5	3x16
80/1515	50x17x0.8	2x3.5	3x16
80/1517	60x17x0.8	2x3.5	3x16
80/1519	70x19x1	3x3.5	3x16
80/1521	80x19x1	3x3.5	3x16



Materiales- (Acabados) / Materials- (Treatments) / Matériaux- (Finitions)
H (ZI)

Ref.85

Placas colgador iberia - *Keyhole mounting plates* - Plaques penderie

Ref./Cod.	mm Medidas Size Dimension	Agujeros x ømm Holes Trou	Ø Tornillo Screw Vis
85/1524	40x12.5x2	2x3.5	3x16



Materiales- (Acabados) / Materials- (Treatments) / Matériaux- (Finitions)
H (ZI)

Anilla con tirafondo - Ring with screw - Anneau avec vis

Ref.627



Ref./Cod.	mm Medidas Size Dimension
627/4187	Ø65

Materiales- (Acabados) / Materials- (Treatments) / Matériaux- (Finitions)

H (ZI) - (PA)



Anilla con base - Ring with plate - Anneau avec plaque

Ref.627



Ref./Cod.	mm Medidas Size Dimension
627/4188	Ø65x70x45

Materiales- (Acabados) / Materials- (Treatments) / Matériaux- (Finitions)

H (ZI) - (PA)



Gancho con base - Hook with plate - Crochet avec plaque

Ref.627



Ref./Cod.	mm Medidas Size Dimension
627/4189	44x45

Materiales- (Acabados) / Materials- (Treatments) / Matériaux- (Finitions)

H (ZI) - (PA)



Gancho con base - Hook with plate - Crochet avec plaque

Ref.627



Ref./Cod.	mm Medidas Size Dimension
627/4190	70x45

Materiales- (Acabados) / Materials- (Treatments) / Matériaux- (Finitions)

H (ZI) - (PA)



Ref./Cod.	mm Medidas Size Dimension	Denominación Name Dénomination
469/2974	20x2,5x65	Colgador simple <i>Single hanger</i> Porte-manteu simple



Características / *Characteristics* / *Caractéristiques*

Colgadores muy utilizados en vestuarios y cabinas sanitarias.
Destacan por su sencillez, coste y durabilidad /

*Frequently used in changing rooms and toilets cubicles.
They stand out because of its simplicity, cost and durability /*

Très utilisés dans les vestiaires et cabines sanitaires.
Ils se distinguent par leur simplicité, coût et durabilité.

Materiales- (Acabados) / *Materials- (Treatments)* / *Matériaux- (Finitions)*

H (NI)

I304 (SA)

Ref./Cod.	mm Medidas Size Dimension	Denominación Name Dénomination
469/2975	20x2,5x152	Colgador doble <i>Double hanger</i> Porte-manteu double



Características / *Characteristics* / *Caractéristiques*

Colgadores muy utilizados en vestuarios y cabinas sanitarias.
Destacan por su sencillez, coste y durabilidad /

*Frequently used in changing rooms and toilets cubicles.
They stand out because of its simplicity, cost and durability /*

Très utilisés dans les vestiaires et cabines sanitaires.
Ils se distinguent par leur simplicité, coût et durabilité.

Materiales- (Acabados) / *Materials- (Treatments)* / *Matériaux- (Finitions)*

H (NI)

I304 (SA)

Colgadores - Hangers - Porte-manteu

Ref.603



Ref./Cod.	mm	Medidas Size Dimension	Denominación Name Dénomination
603/2984		48mm	Colgador puntos pequeño / <i>Small hanger</i> / Petit porte-manteu

Materiales- (Acabados) / Materials- (Treatments) / Matériaux- (Finitions)

Z (NIM)



Colgadores - Hangers - Porte-manteu

Ref.603



Ref./Cod.	mm	Medidas Size Dimension	Denominación Name Dénomination
603/2985		145mm	Colgador puntos grande / <i>Big hanger</i> / Grand porte-manteu

Materiales- (Acabados) / Materials- (Treatments) / Matériaux- (Finitions)

Z (NIM)



Colgadores - Hangers - Porte-manteu

Ref.603



Ref./Cod.	mm	Medidas Size Dimension	Denominación Name Dénomination
603/2987		43x29x23	Colgador circular / <i>Circular type hanger</i> / Porte-manteu circulaire

Materiales- (Acabados) / Materials- (Treatments) / Matériaux- (Finitions)

Z (CR) - (GR)



Colgadores - Hangers - Porte-manteu

Ref.603



Ref./Cod.	mm	Medidas Size Dimension	Denominación Name Dénomination
603/2988		39x29x33	Colgador bola / <i>Ball type hanger</i> / Porte-manteu boule

Materiales- (Acabados) / Materials- (Treatments) / Matériaux- (Finitions)

Z (NIM)



Ref.625

Colgador múltiples ganchos - *Multiple hook hanger* - Crochet multiple

Ref./Cod.	mm Medidas Size Dimension	Nº Perchas Hooks num.
625/4217	40x220x7	2
625/4172	40x340x7	3
625/4218	40x450x7	4



Materiales- (Acabados) / Materials- (Treatments) / Matériaux- (Finitions)

AL (PIBL) - (PING) - (PIGR)

Ref.625

Colgador corbatero - *Tie hanger* - Accroche-cravate

Ref./Cod.	Medida / Size Dimension B
620/4146	250 mm
620/4147	300 mm
620/4148	350 mm
620/4149	400 mm
620/4150	450 mm
620/4151	500 mm
620/4152	550 mm
620/4153	600 mm



Materiales- (Acabados) / Materials- (Treatments) / Matériaux- (Finitions)

H (NI)

Ref.19

Corbateros - *Tie hanger* - Penderie

Ref./Cod.	mm Medidas Size Dimension	Agujeros x ømm Holes Trou	Ø Tornillo Screw Vis
19/7001	ø5x250	4x3.5	3x16
19/7002	ø5x300	4x3.5	3x16
19/7003	ø5x350	4x3.5	3x16
19/7004	ø5x400	4x3.5	3x16
19/7005	ø5x450	4x3.5	3x16
19/7006	ø5x500	4x3.5	3x16
19/7007	ø5x550	4x3.5	3x16
19/7110	ø5x600	4x3.5	3x16



Materiales- (Acabados) / Materials- (Treatments) / Matériaux- (Finitions)

H (PU) - (NI)

Asa fija - Handle - Poignée

Ref.210



Ref./Cod.	mm Medidas Size Dimension	Agujeros x ømm Holes Trou	ø Tornillo Screw Vis	
210/324	200x25x4	2x7	5x25	
210/325	220x30x5	2x7	5x25	

Materiales- (Acabados) / Materials- (Treatments) / Matériaux- (Finitions)

I304 (SA)

I316 (SA)



Asa abatible - Handle - Poignée

Ref.455



Ref./Cod.	mm Medidas Size Dimension	Agujeros x ømm Holes Trou	ø Tornillo Screw Vis	
455/2806	30x140x2 - Ø5	3x7	4.5x25	

Materiales- (Acabados) / Materials- (Treatments) / Matériaux- (Finitions)

I304 (SA)

I316 (SA)



Ref.455

Asa abatible - Handle - Poignée

Ref./Cod.	mm Medidas Size Dimension	Agujeros x ømm Holes Trou	Ø Tornillo Screw Vis
455/1892	35x95x1 - Ø5	4x5.2	4x20
455/2798	35x125x1 - Ø5	4x5.2	4x20



Materiales- (Acabados) / Materials- (Treatments) / Matériaux- (Finitions)

■ H (LA) - (BRI) - (BR)



Ref.771

Asa abatible - Handle - Poignée

Ref./Cod.	mm Medidas Size Dimension	Agujeros x ømm Holes Trou	Ø Tornillo Screw Vis
771/4788	90x75x1 - Ø5	4x4	4x20
771/4835	110x95x1 - Ø7	4x4.8	4x20



Materiales- (Acabados) / Materials- (Treatments) / Matériaux- (Finitions)

■ H (LA) - (BRI) - (ZI)



COMPASES Y GUÍAS CAJÓN

LID/FLAP STAY HINGES AND DRAWER SLIDES

CHARNIÈRE COMPAS, GLISSIÈRES ET COULISSEAU

PAG.168-173



Bisagras trampolín - *Flap stay hinge* - Charnière compas

Ref.13

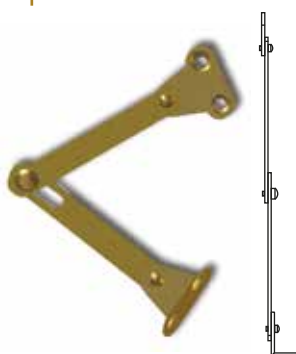

Ref./Cod.	mm Medidas Size Dimension	Agujeros x ømm Holes Trou	Ø Tornillo Screw Vis
13/2001	130x10x1.5	4x4	3x16
13/2002	160x10x1.5	4x4	3x16
13/2003	200x10x1.5	4x4	3x16
13/2004	250x10x1.5	4x4	3x16
13/2005	300x10x1.5	4x4	3x16

Materiales- (Acabados) / Materials- (Treatments) / Matériaux- (Finitions)

H (BRI) - (NI)

L (B)



Bisagras caballete - *Lid stay hinge* - Charnière compas pour chevalet

Ref.88



Ref./Cod.	mm Medidas Size Dimension	Agujeros x ømm Holes Trou	Ø Tornillo Screw Vis
88/2449	216x15x1	2x4,2	3x16

Materiales- (Acabados) / Materials- (Treatments) / Matériaux- (Finitions)

H (ZI) - (NI)



Bisagras caballete - *Lid stay hinges* - Charnière compas pour chevalet

Ref.88



Ref./Cod.	mm Medidas Size Dimension	Agujeros x ømm Holes Trou	Ø Tornillo Screw Vis
88/6065	130x12x2	2x3	3x16
88/6066	160x12x2	2x3	3x16
88/6067	200x12x2	2x3	3x16
88/6068	250x12x2	2x3	3x16
88/6069	300x12x2	2x3	3x16
88/6070	350x12x2	2x3	3x16

Materiales- (Acabados) / Materials- (Treatments) / Matériaux- (Finitions)

H (ZI)



Ref.16

Bisagras compás - Lid stay hinge - Charnière compas

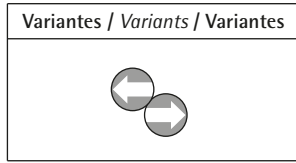

Ref./Cod.	mm Medidas Size Dimension	Agujeros x ømm Holes Trou	Ø Tornillo Screw Vis
16/2708	200x14x2	4x4	3x16

Materiales- (Acabados) / Materials- (Treatments) / Matériaux- (Finitions)

H (NI)



Ref.16

Bisagras compás - Lid stay hinge - Charnière compas

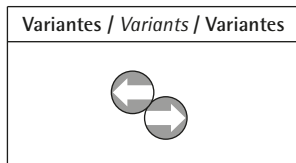

Ref./Cod.	mm Medidas Size Dimension	Funcionamiento Operation Fonctionnement	Agujeros x ømm Holes Trou	Ø Tornillo Screw Vis
16/6036	130x12x2	Izquierda/Left/Gauche	4x4	3x16
16/6037	160x12x2	Izquierda/Left/Gauche	4x4	3x16
16/6038	200x12x2	Izquierda/Left/Gauche	4x4	3x16
16/6039	250x12x2	Izquierda/Left/Gauche	4x4	3x16
16/6040	300x12x2	Izquierda/Left/Gauche	4x4	3x16
16/6041	350x12x2	Izquierda/Left/Gauche	4x4	3x16
16/6043	130x12x2	Derecha/Right/Droite	4x4	3x16
16/6044	160x12x2	Derecha/Right/Droite	4x4	3x16
16/6045	200x12x2	Derecha/Right/Droite	4x4	3x16
16/6046	250x12x2	Derecha/Right/Droite	4x4	3x16
16/6047	300x12x2	Derecha/Right/Droite	4x4	3x16
16/6048	350x12x2	Derecha/Right/Droite	4x4	3x16

Materiales- (Acabados) / Materials- (Treatments) / Matériaux- (Finitions)

H (NI)

L (NI)

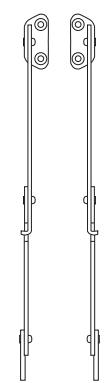

Izquierdas

Derechas

Bisagras compás nylon - Flap stay hinge - Coulisseaux

Ref.14

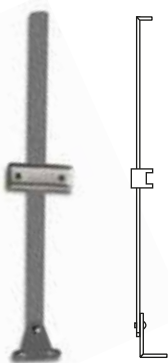

Ref./Cod.	mm Medidas Size Dimension	Agujeros x ømm Holes Trou	Ø Tornillo Screw Vis
14/2029	150x10x1.5	2x4	3x16
14/2030	200x10x1.5	2x4	3x16
14/2031	250x10x1.5	2x4	3x16
14/2032	300x10x1.5	2x4	3x16

Materiales- (Acabados) / Materials- (Treatments) / Matériaux- (Finitions)

H (Z1)



Amortiguador de gas - Lid stay gas struts - Amortisseur de gaz

Ref.617



Subida



Bajada

Ref./Cod.	mm Medidas Size Dimension	Fuerza Strength Force	Variantes Variants Variantes
617/4142	247mm	60 Nm	Subida / Bajada
617/4140	247mm	80 Nm	Subida / Bajada
617/4143	247mm	100 Nm	/ Bajada
617/4528	247mm	120 Nm	Subida /
617/4529	247mm	150 Nm	Subida /

Variantes / Variants / Variantes



Materiales- (Acabados) / Materials- (Treatments) / Matériaux- (Finitions)

H (NI)



Características/ Characteristics/ Caractéristiques

Incluye tornillos y elementos de fijación /
Supplied with screws /
Livrée avec ses vis



Topes de apertura para puerta - *Opening stoppers* - Arrêt de porte

Ref./Cod.	mm Medidas Size Dimension	Agujeros x ømm Holes Trou	Ø Tornillo Screw Vis	
325/929	40x2 (Ø4)	4x4,5	3,5x20	

Materiales- (Acabados) / *Materials- (Treatments)* / *Matériaux- (Finitions)*

I304 (B)



50 u.



Bisagras para escalera - *Ladder hinges* - Charnières pour échelle

Ref./Cod.	mm Medidas Size Dimension	Agujeros x ømm Holes Trou	Ø Tornillo Screw Vis	
500/2320	140x2,5	3x5,5	6	
500/2321	160x2,5	3x5,5	6	
500/2322	190x2,5	3x5,5	6	
500/2323	200x2,5	3x5,5	6	
500/2324	220x2,5	3x5,5	6	

Materiales- (Acabados) / *Materials- (Treatments)* / *Matériaux- (Finitions)*

H (ZI) - (LA)

I304 (B)



10 u.



Conjunto 2 guías cajón extracción total con fijación lateral - Drawer slides set - Glissières et coulisseau

Ref.672



Ref./Cod.	Largo x Ancho	Chapa mm	Capacidad
672/4462	200x35 mm	1x1x1	28 kgs
672/4463	250x35 mm	1x1x1	28 kgs
672/4464	300x35 mm	1x1x1	28 kgs
672/4465	350x35 mm	1x1x1	28 kgs
672/4466	400x35 mm	1x1x1	28 kgs
672/4467	450x35 mm	1x1x1	28 kgs
672/4468	500x35 mm	1x1x1	28 kgs

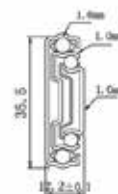

Materiales- (Acabados) / Materials- (Treatments) / Matériaux- (Finitions)

H (Zl)



Conjunto 2 guías cajón extracción total con fijación lateral - Drawer slides set - Glissières et coulisseau

Ref.670



Ref./Cod.	Largo x Ancho	Chapa mm	Capacidad
670/4452	200x44 mm	1x1x1	38 kgs
670/4453	250x44 mm	1x1x1	38 kgs
670/4454	300x44 mm	1x1x1	38 kgs
670/4455	350x44 mm	1x1x1	38 kgs
670/4456	400x44 mm	1x1x1	38 kgs
670/4826	450x44 mm	1x1x1	38 kgs
670/4827	500x44 mm	1x1x1	38 kgs

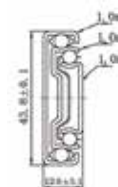

Materiales- (Acabados) / Materials- (Treatments) / Matériaux- (Finitions)

H (Zl)



Ref.671

Conjunto 2 guías cajón extracción total con fijación lateral - Drawer slides set - Glissières et coulisseau

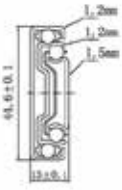

Ref./Cod.	Largo x Ancho	Chapa mm	Capacidad
671/4457	450x45 mm	1,2x1,2x1,5	45 kgs
671/4458	500x45 mm	1,2x1,2x1,5	45 kgs
671/4459	550x45 mm	1,2x1,2x1,5	45 kgs
671/4460	600x45 mm	1,2x1,2x1,5	45 kgs
671/4461	700x45 mm	1,2x1,2x1,5	45 kgs
671/4586	800x45 mm	1,2x1,2x1,5	45 kgs
671/4587	900x45 mm	1,2x1,2x1,5	45 kgs
671/4588	1000x45 mm	1,2x1,2x1,5	45 kgs



Materiales- (Acabados) / Materials- (Treatments) / Matériaux- (Finitions)

■ H (Zl)

Ref.673

Conjunto 2 guías cajón extracción total con fijación lateral e inferior - Drawer slides set - Glissières et coulisseau

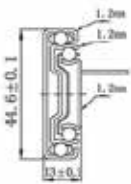

Ref./Cod.	Largo x Ancho	Chapa mm	Capacidad
673/4469	300x45 mm	1,2x1,2x1,2	45 kgs
673/4470	350x45 mm	1,2x1,2x1,2	45 kgs
673/4471	400x45 mm	1,2x1,2x1,2	45 kgs
673/4472	450x45 mm	1,2x1,2x1,2	45 kgs
673/4473	500x45 mm	1,2x1,2x1,2	45 kgs

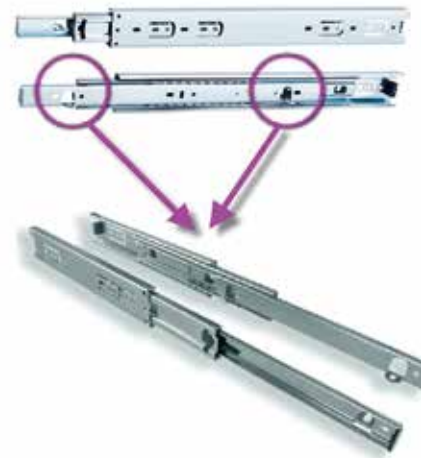

Materiales- (Acabados) / Materials- (Treatments) / Matériaux- (Finitions)

■ H (Zl)

ESTUCHERÍA (BISAGRAS, CIERRES Y ACCESORIOS)

HINGES AND ACCESSORIES FOR CASES

CHARNIÈRES ET ACCESSOIRES POUR ÉTUIS

PAG.176-187

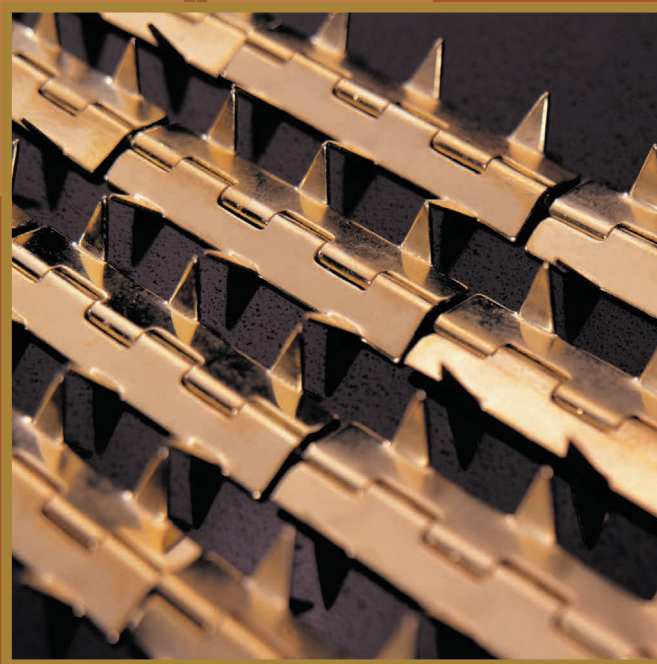

Ref. 446/1808
Humidificador - *Humidifier* - Humidificater

Ref. 446/1805
Pasador cerradura - *Pin Lock*- Goupille Serrure

Ref. 446/1819
Cantonera - *Loafer* - Cantonnière

Ref. 446/1811-12
Bisagra de ángulo - *Angle Hinge* - *Charnière d'angle*

Ref. 446/1806-1807
Higrómetro - *Higrometer* - Hygromètre

Ref. 446/4616
Cerradura de embutir - *Lock for cases* - *Serrure pour étuis*

Ref. 446/1810
Bocallave - *Eye of the lock* - *Trou de la serrure*



Ref.254

Bisagra ángulo retenida - *Quadrant hinges* - *Quadrant charnières*

Ref./Cod.	mm Medidas Size Dimension	Agujeros x ømm Holes Trou	Ø Tornillo Screw Vis
254/418	37x45x0.8	7x2.30	

Materiales- (Acabados) / *Materials- (Treatments)* / *Matériaux- (Finitions)*

L (PU)

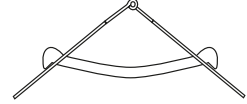

Ref.446

Bisagra ángulo retenida - *Quadrant hinges* - *Quadrant charnières*

Ref./Cod.	mm Medidas Size Dimension	Agujeros x ømm Holes Trou	Ø Tornillo Screw Vis
446/1811	5x30x0.8	6x2.5	2.2x8 

Materiales- (Acabados) / *Materials- (Treatments)* / *Matériaux- (Finitions)*

L (O)



Ref.446

Bisagra ángulo retenida - *Quadrant hinges* - *Quadrant charnières*

Ref./Cod.	mm Medidas Size Dimension	Agujeros x ømm Holes Trou	Ø Tornillo Screw Vis
446/1812	7x41x1	6x2.5	2.2x8 

Materiales- (Acabados) / *Materials- (Treatments)* / *Matériaux- (Finitions)*

L (O)



Ref.446

Bisagra ángulo retenida - *Quadrant hinges* - *Quadrant charnières*

Ref./Cod.	mm Medidas Size Dimension	Agujeros x ømm Holes Trou	Ø Tornillo Screw Vis
446/1814	76x9x1	4x2.5	2.2x8 

Materiales- (Acabados) / *Materials- (Treatments)* / *Matériaux- (Finitions)*

L (O)



Bisagras de doble hoja para estuches - *Double-edged hinges for cases* - Charnières à double lame pour étuis

Ref.233



Ref./Cod.	mm Medidas Size Dimension	Agujeros x ømm Holes Trou	Ø Clavos Nails Clous
233/373	22x12x0.6	4x1.5	1x10
233/374	50x12x0.6	6x1.75	1x10
233/375	60x12x0.6	6x1.75	1x10
233/376	70x12x0.6	6x1.75	1x10
233/377	80x12x0.6	6x1.75	1x10
233/378	90x12x0.6	6x1.75	1x10
233/379	120x12x0.6	6x1.75	1x10

Materiales- (Acabados) / Materials- (Treatments) / Matériaux- (Finitions)

L (PU)

Bisagras de doble hoja para estuches - *Double-edged hinges for cases* - Charnières à double lame pour étuis

Ref.234



Ref./Cod.	mm Medidas Size Dimension	Agujeros x ømm Holes Trou	Ø Clavos Nails Clous
234/380	15x10x0.6	4x1.25	1x10
234/381	20x10x0.6	4x1.25	1x10
234/382	25x10x0.6	6x1.25	1x10
234/383	30x10x0.6	6x1.25	1x10
234/384	40x10x0.6	6x1.25	1x10

Materiales- (Acabados) / Materials- (Treatments) / Matériaux- (Finitions)

L (PU)

Bisagras de una hoja para estuches - *Single-edged hinges for cases* - Charnières à simple lame pour étuis

Ref.235



Ref./Cod.	mm Medidas Size Dimension	Agujeros x ømm Holes Trou	Ø Clavos Nails Clous
235/385	18x10x0.4	4x1.25	1x10
235/386	18x15x0.4	4x1.25	1x10
235/387	25x15x0.4	4x1.25	1x10
235/388	30x15x0.4	4x1.25	1x10

Materiales- (Acabados) / Materials- (Treatments) / Matériaux- (Finitions)

L (PU)

Ref.236

Bisagras grapadas de puntas - *Point -stapled hinges* - Charnières agrafées à pointes

Ref./Cod.	mm	Medidas Size Dimension
236/389	20x10x0.4	
236/390	30x8x0.4	

Materiales- (Acabados) / Materials- (Treatments) / Matériaux- (Finitions)

H (LA) - Ref. 236/389

L (PU) - Ref. 236/390

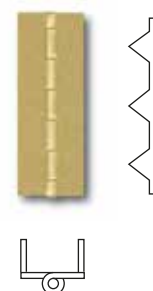

Ref.237

Bisagras para estuches - *Barbed hinges* - Charnières pour étuis

Ref./Cod.	mm	Medidas Size Dimension
237/392	22.5x15x0.5	

Materiales- (Acabados) / Materials- (Treatments) / Matériaux- (Finitions)

H (LA)



Ref.320

Bisagras grapada de puntas retenidas a 90° - *Point stapled hinge retained at 90°* - Charnière agrafée à pointes retenues à 90°

Ref./Cod.	mm	Medidas Size Dimension
320/842	19x17x0.5	

Materiales- (Acabados) / Materials- (Treatments) / Matériaux- (Finitions)

H (LA) - (NI) - (BRI)



Ref.239

Bisagras redondas para estuches retenidas a 110° - *Barbed hinges for cases retained at 110°* - Charnières rondes pour étuis retenues à 110°

Ref./Cod.	mm	Medidas Size Dimension
239/394	29x25x0.5	

Materiales- (Acabados) / Materials- (Treatments) / Matériaux- (Finitions)

H (LA)



Bisagras con resorte retenida a 90° -
Barbed hinges retained at 90° with spring - Charnière à ressort retenue à 90°

Ref.240



Ref./Cod.	mm Medidas Size Dimension
240/395	29x16x0.5

Materiales- (Acabados) / Materials- (Treatments) / Matériaux- (Finitions)

H (LA)

Bisagras con resorte retenida a 90° -
Spring hinges retained at 90° - Charnière à ressort retenue à 90°

Ref.241



Ref./Cod.	mm Medidas Size Dimension
241/396	82x15.5x0.5

Materiales- (Acabados) / Materials- (Treatments) / Matériaux- (Finitions)

H (LA) - (LA.L)

Bisagras invisibles - Invisible hinges - Charnières invisibles

Ref.242



Ref./Cod.	mm Medidas Size/Dimension D x L	ømm Agujeros para embutir Holes to stuff Trou pour boucher
242/1562	Ø3,5 x 35	3,3
242/397	Ø5 x 14	4,8
242/398	Ø5 x 25	4,8

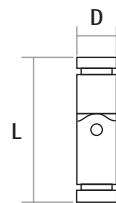

Materiales- (Acabados) / Materials- (Treatments) / Matériaux- (Finitions)

L (PU) - (NI)

Opciones de montaje

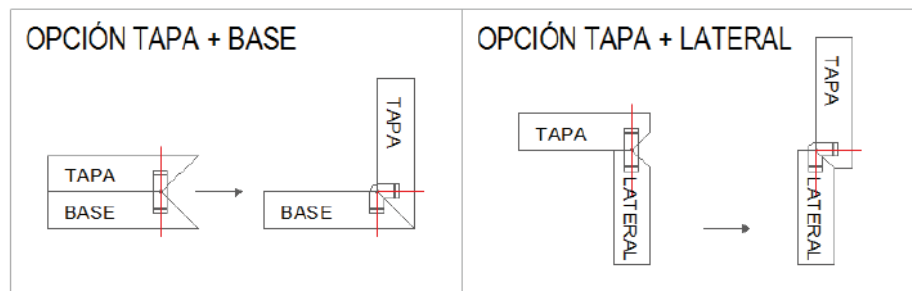

Ref.446

Bisagras para estuches - Case hinges - Charnières pour étuis

Ref./Cod.	mm Medidas Size Dimension	Agujeros x ømm Holes Trou	Ø Tornillo Screw Vis
446/1815	20x16x0,7	4x2,5	2,2x8

Materiales- (Acabados) / Materials- (Treatments) / Matériaux- (Finitions)

H (LA) - (NI)



Ref.446

Bisagras para estuches - Case hinges - Charnières pour étuis

Ref./Cod.	mm Medidas Size Dimension	Agujeros x ømm Holes Trou	Ø Tornillo Screw Vis
446/1816	35x18x1	4x2,5	2,2x8

Materiales- (Acabados) / Materials- (Treatments) / Matériaux- (Finitions)

L (PU)



Ref.320 Bisagras para estuches retenida - Case hinge retained - Charnière pour étuis retenue

Ref./Cod.	mm Medidas Size Dimension	Agujeros x ømm Holes Trou	Ø Tornillo Screw Vis
320/1712	37,5x25x0,65	4x3	2,2x8

Materiales- (Acabados) / Materials- (Treatments) / Matériaux- (Finitions)

H (LA)



Ref.259

Bisagras para estuches - Case hinge - Charnière pour étuis

Ref./Cod.	mm Medidas Size Dimension	Agujeros x ømm Holes Trou	Ø Tornillo Screw Vis
259/423	26x15x0,3	7x2,3	

Materiales- (Acabados) / Materials- (Treatments) / Matériaux- (Finitions)

L (PU)



Tarabilla - Turn button catch - Loquet

Ref.258

258/322 258/343



Ref./Cod.	mm Medidas Size Dimension
258/322	23x0.4
258/343	17x0.4

Materiales- (Acabados) / Materials- (Treatments) / Matériaux- (Finitions)

 (LA)

 (PU)

Cierre estuche con puntas - Fastener for cases - Fermeture a pointes pour étuis

Ref.250



Ref./Cod.

250/414

Materiales- (Acabados) / Materials- (Treatments) / Matériaux- (Finitions)

 (LA)

Cierre violín - Fastener violin type - Fermeture type violin

Ref.251



Ref./Cod.

251/415

Materiales- (Acabados) / Materials- (Treatments) / Matériaux- (Finitions)

 (PU)

Cierre de muelle - Fastener spring type - Fermeture type ressort

Ref.252



Ref./Cod.

252/416

Materiales- (Acabados) / Materials- (Treatments) / Matériaux- (Finitions)

 (PU)

Variantes / Variants / Variantes



Cierres para estuches - *Fasteners for cases* - Fermetures pour étuis

Ref./Cod.	Tamaño Size Dimension	Medidas Size Dimension	mm	Puntas Points Pointes
244/400	Pequeño - <i>Small</i> - Petit	20		1x10
244/401	Mediano - <i>Medium</i> - Moyen	24		1x10
244/402	Grande - <i>Large</i> - Grand	32		1x10



Materiales- (Acabados) / *Materials- (Treatments)* / Matériaux- (Finitions)

L (PU)

Cierres con puntas para estuches - *Pointed fasteners for cases* - Fermetures à pointes pour étuis

Ref./Cod.	Tamaño Size Dimension	Medidas Size Dimension
245/403	Pequeño - <i>Small</i> - Petit	21
245/404	Mediano - <i>Medium</i> - Moyen	32
245/405	Grande - <i>Large</i> - Grand	40



Materiales- (Acabados) / *Materials- (Treatments)* / Matériaux- (Finitions)

H (LA)

Cierres para estuches - *Fasteners for cases* - Fermetures pour étuis

Ref./Cod.	Tamaño Size Dimension	Medidas Size Dimension	mm	Puntas Points Pointes
246/406	Pequeño - <i>Small</i> - Petit	20		1x10
246/407	Mediano - <i>Medium</i> - Moyen	30		1x10
246/408	Grande - <i>Large</i> - Grand	40		1x10



Materiales- (Acabados) / *Materials- (Treatments)* / Matériaux- (Finitions)

H (LA)

Cierres con puntas para estuches - *Pointed fasteners for cases* - Fermetures à pointes pour étuis

Ref./Cod.	Tamaño Size Dimension	Medidas Size Dimension
247/409	Pequeño - <i>Small</i> - Petit	20
247/410	Mediano - <i>Medium</i> - Moyen	30
247/411	Grande - <i>Large</i> - Grand	40



Materiales- (Acabados) / *Materials- (Treatments)* / Matériaux- (Finitions)

H (LA)



Ref./Cod.	Denominación Name Dénomination
446/4616	Conjunto cerradura completa con sus accesorios y tornillos <i>Full set lock for small wooden box</i> Kit complet serrure de coffret



Ref./Cod.	Denominación Name Dénomination
446/4617	Conjunto cerradura y contrafrente con tornillos <i>Lock with front trim panel for small wooden box</i> Serrure de coffret avec plaque frontal



Ref./Cod.	Denominación Name Dénomination
446/4618	Conjunto cerradura y pasador con tornillos <i>Lock with pin for small wooden box</i> Serrure de coffret avec broche

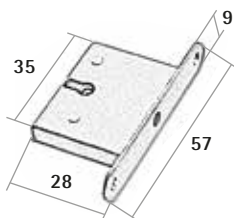

Ref./Cod.	Denominación Name Dénomination
446/1809	Llave / Key / Clé
446/1810	Bocallave / Key escutcheon / Entrée clé
446/1805	Pasador para cerradura / Pin to lock / Axe



446/1809



446/1810



446/1805

Características / Characteristics / Caractéristiques

Cerradura de calidad en latón para estuches y pequeñas cajitas.
Se puede combinar con varios accesorios, con frontal de cierre en placa o pasador. Sirve para puertas normales o correderas gracias al diseño de su pestillo.
*High quality brass lock for small wooden boxes.
Either with front trim panel either with pin. Can be used either with standard either with sliding doors.*
Serrure de qualité en laiton pour des coffrets.
Divers combinaisons possibles, avec plaque frontal ou avec broche. Pour des portes standard ou coulissantes

Materiales- (Acabados) / Materials- (Treatments) / Matériaux- (Finitions)

L (O) - (NI)



Ref.255

Compás para estuches - *Flap stay hinges* - Charnière compas

Ref./Cod.	mm Medidas abierta Size open Dimension ouvert
255/419	75mm



Materiales- (Acabados) / Materials- (Treatments) / Matériaux- (Finitions)

H (LA) - (NI)

Ref.446

Compás para estuches - *Box angle, squared* - Pièce etui, équerre

Ref./Cod.
446/1823



Materiales- (Acabados) / Materials- (Treatments) / Matériaux- (Finitions)

H (LA) - (BR)

L (PU)

Ref.256-257

Ganchos - *Hooks* - Crochets

Ref./Cod.	Denominación Name Dénomination
256/420	Gancho medalla / <i>medal</i> / médaille
257/421	Gancho colgante / <i>hanging</i> / baillant

256/420



257/421



Materiales- (Acabados) / Materials- (Treatments) / Matériaux- (Finitions)

L (PU)

Cantoneras - Corner pieces - Cornières

Ref.253



Ref./Cod.	mm Medidas Size Dimension	Clavos Nails Clous
253/417	35x35x0,6	1x10

Materiales- (Acabados) / Materials- (Treatments) / Matériaux- (Finitions)

L (PU) - (NI)

Higrómetro - Hygrometer - Hydromètre

Ref.446



Ref./Cod.	mm Medidas Size Dimension
446/1806	Ø 32
446/1807	Ø 42

Materiales- (Acabados) / Materials- (Treatments) / Matériaux- (Finitions)

L (O)

Humificador - Humidifier - Humidificateur

Ref.446



Ref./Cod.	mm Medidas Size Dimension
446/1808	Ø 50

Materiales- (Acabados) / Materials- (Treatments) / Matériaux- (Finitions)

L (O)

Variantes / Variants / Variantes

Se sirven conjuntamente
o por separado /

They are served together
or separately /

Ils sont servis ensemble
ou séparément

Ref./Cod.	mm Medidas Size Dimension
446/1821	Ø5x4
446/1822	Ø10x3

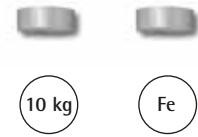

Materiales- (Acabados) / Materials- (Treatments) / Matériaux- (Finitions)

IMÁN NIQUELADO / NICKEL FINISH MAGNET / AIMANT NICKELAGE

Tornillos para estuchería - Screws - Vis

Ref./Cod.	d	D	P. máx.	Longitud (L) Length Longueur
446/1232	1,9	3,5	1	7,5
446/1820	2,2	4	1,2	8

Materiales- (Acabados) / Materials- (Treatments) / Matériaux- (Finitions)

H (LA)

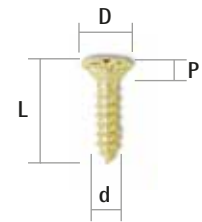

Clavos para estuchería - Nails - Clous

Ref./Cod.	mm Medidas Size Dimension
261/430	Ø 1x10
261/431	Ø 1x10

Materiales- (Acabados) / Materials- (Treatments) / Matériaux- (Finitions)

H (LA) 261/430

L (PU) 261/431



PIEZAS ARTESANALES MENORQUINAS

TYPICAL MENORCA FITTINGS

FERRURES TYPIQUE MINORQUINES

PAG.190-195



Conjunto pestillo menorquín lujo - *Rim latch and handle set - Loquet poucier poignée*

Ref.225

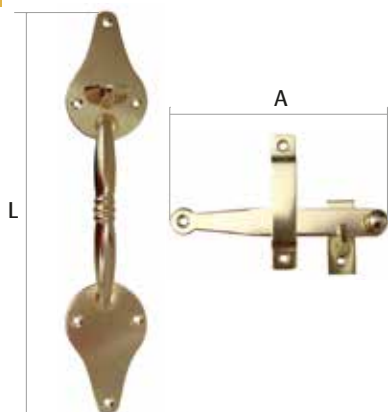

Ref./Cod.	Denominación Name Dénomination	L	A
225/342	Pequeño Lujo	215 mm	120 mm
225/343	Grande Lujo	245 mm	140 mm

Materiales- (Acabados) / Materials- (Treatments) / Matériaux- (Finitions)

L (PU)



Conjunto pestillo menorquín sencillo - *Rim latch and handle set - Loquet poucier poignée*

Ref.225

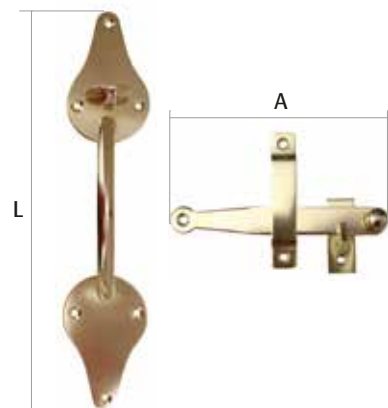

Ref./Cod.	Denominación Name Dénomination	L	A
225/1860	Pequeño Sencillo	215 mm	120 mm

Materiales- (Acabados) / Materials- (Treatments) / Matériaux- (Finitions)

L (PU)

I304 (B)



Maneta puerta Menorquina - *Gate latches hardware - Poignée de porte d'entrée*

Ref.227



Ref./Cod.	mm Medidas Size Dimension
227/4451	143x93x43

Materiales- (Acabados) / Materials- (Treatments) / Matériaux- (Finitions)

L (PU)



Ref./Cod.	mm Medidas / Size Dimension Ø x L	Nº puentes incluidos Nº of parts included Nº de pièces compris
226/344	Ø8x150	3
226/1852	Ø8x200	3
226/1853	Ø8x250	3
226/1854	Ø8x300	3
226/1855	Ø8x400	4
226/1856	Ø8x600	4
226/1861	Ø12x250	3
226/1862	Ø12x400	4
226/1863	Ø12x600	4

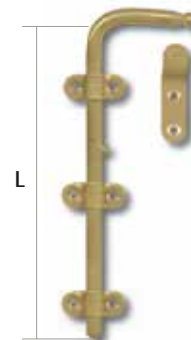

Materiales- (Acabados) / Materials- (Treatments) / Matériaux- (Finitions)	
L	(B)
1304	(B)
1316	(B)



Ref./Cod.	mm Medidas / Size Dimension Ø x A
228/367	Ø8x120

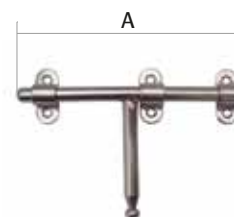

Materiales- (Acabados) / Materials- (Treatments) / Matériaux- (Finitions)	
L	(B)
1304	(B)
1316	(B)



Ref./Cod.	mm Medidas / Size Dimension Ø x A	
227/2722	Ø4x100	Con placa atornillable/With plate/Avec plaque
227/2723	Ø4x150	Con placa atornillable/With plate/Avec plaque
227/2724	Ø4x200	Con placa atornillable/With plate/Avec plaque

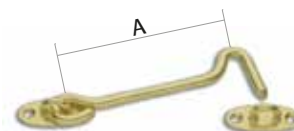

Materiales- (Acabados) / Materials- (Treatments) / Matériaux- (Finitions)	
L	(B)
1304	(B)
1316	(B)



Canet lateral para cementar - *Shutter dog* - Arrêt de volet à sceller

Ref.227

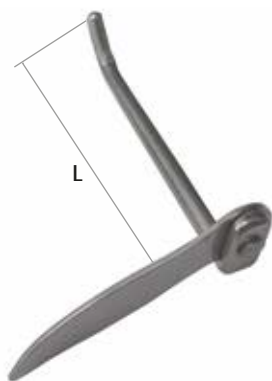

Ref./Cod.	Denominación Name Dénomination	mm Medidas/Size Dimension Ø x L	Material (Acabado) Material (Treatment) Matériaux (Finition)
227/365	Canet lateral	Ø8x120	I304 (B)
227/366	Canet lateral	Ø8x180	I304 (B)
227/1864	Canet lateral	Ø10x120	L (PU)
227/1866	Canet lateral	Ø10x180	L (PU)



Canet rotativo para cementar - *Shutter dog* - Arrêt de volet à sceller

Ref.227

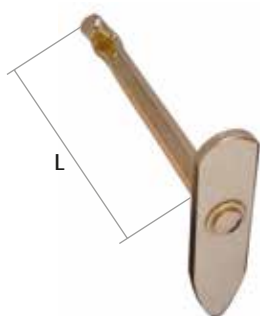

Ref./Cod.	Denominación Name Dénomination	mm Medidas/Size Dimension Ø x L
227/1872	Canet rotativo	Ø10x120
227/1873	Canet rotativo	Ø10x180



Materiales- (Acabados) / Materials- (Treatments) / Matériaux- (Finitions)

L (PU)

I304 (B)

Canet lateral con taco expansión - *Shutter dog* - Arrêt de volet à cheville

Ref.227



Ref./Cod.	Denominación Name Dénomination	mm Medidas/Size Dimension Ø x L
227/1867	Canet lateral	Ø8x40
227/1868	Canet lateral	Ø8x55
227/1869	Canet lateral	Ø8x70



Materiales- (Acabados) / Materials- (Treatments) / Matériaux- (Finitions)

I304 (B)

Canet rotativo con taco expansión - *Shutter dog* - Arrêt de volet à cheville

Ref.227



Ref./Cod.	Denominación Name Dénomination	mm Medidas/Size Dimension Ø x L
227/1874	Canet rotativo	Ø10x60
227/1875	Canet rotativo	Ø10x100



Materiales- (Acabados) / Materials- (Treatments) / Matériaux- (Finitions)

I304 (B)

Canet lateral roscado - *Shutter dog* - Arrêt de volet à tige filetée

Ref./Cod.	Denominación Name Dénomination	mm Medidas/Size Dimension Ø x L	R
227/1870	Canet lateral	Ø10x120	40 mm
227/1871	Canet lateral	Ø10x180	40 mm



Materiales- (Acabados) / Materials- (Treatments) / Matériaux- (Finitions)

L (PU)

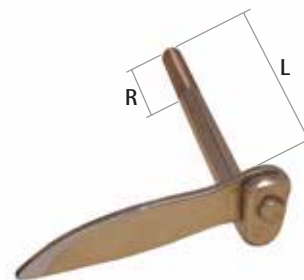
Canet rotativo roscado - *Shutter dog* - Arrêt de volet à tige filetée

Ref./Cod.	Denominación Name Dénomination	mm Medidas/Size Dimension Ø x L	R
227/4662	Canet rotativo	Ø10x120	40 mm
227/4663	Canet rotativo	Ø10x180	40 mm



Materiales- (Acabados) / Materials- (Treatments) / Matériaux- (Finitions)

L (PU)

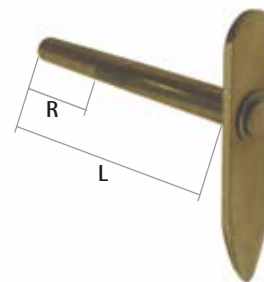

Ref./Cod.	Descripción Name Dénomination	mm Medidas/Size Dimension		Agujeros Holes / Trou Nº x Ømm	ØTornillo Screw Vis
		A x B x C	E x F x H x G		
229/1876	Golfo con correa plana / Straight strap hinges / Penture droite	135x20x5	150x20xHx4	3x5	4,5x25-40
229/368	Golfo con correa plana / Straight strap hinges / Penture droite	135x20x5	200x20xHx4	3x5	4,5x25-40
229/1877	Golfo con correa plana / Straight strap hinges / Penture droite	135x25x5	250x25xHx4	4x5	4,5x25-40
229/1878	Golfo con correa plana / Straight strap hinges / Penture droite	135x25x5	300x25xHx4	5x5	4,5x25-40
230/1879	Golfo con correa codo / Cranket strap hinges / Penture coudée	175x25x5	200x20x35x4	4x5	4,5x25-40
230/370	Golfo con correa codo / Cranket strap hinges / Penture coudée	175x25x5	250x25x35x4	4x5	4,5x25-40
231/1880	Golfo antirrobo / Invisible strap hinges / Penture droite à il intérieur	135x20x5	200x20x40x4	4x5	4,5x25-40
231/371	Golfo antirrobo / Invisible strap hinges / Penture droite à il intérieur	135x20x5	250x25x40x4	5x5	4,5x25-40
232/372	Golfo antirrobo codo / Invisible cranket strap hinges / Penture coudée à il intérieur	190x25x5	250x25x74x4	5x5	4,5x25-40
152/339	Golfo con pernio / Lift off hinges for brick work / Paumelle à sceller	130x20x3	Ex120x23x3	3x5	4,5x25
152/250	Golfo con pernio / Lift off hinges for brick work / Paumelle à sceller	130x20x3	Ex120x38x3	3x5	4,5x25

Materiales- (Acabados) / Materials- (Treatments) / Matériaux- (Finitions)

1304 (B)

1316 (B)

L (B)

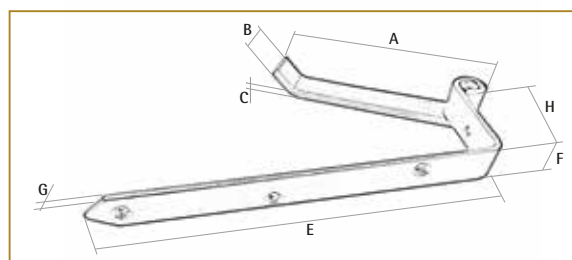
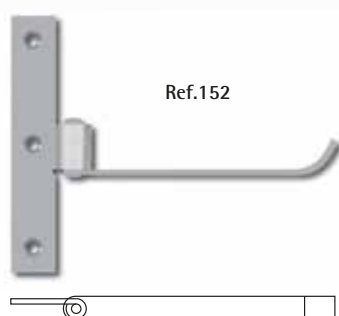
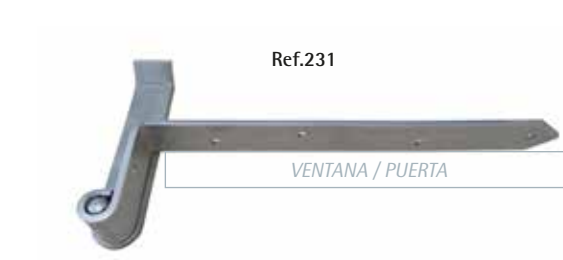

Ref./Cod.	mm	Medidas Size Dimension	Características Characteristics Caractéristiques
238/2351	Ø8mm		3 puntos de cierre/ 3 closing points/ 3 points de fermeture
238/4691	Ø8mm		2 puntos de cierre/ 2 closing points/ 2 points de fermeture

Materiales- (Acabados) / Materials- (Treatments) / Matériaux- (Finitions)

- L (PU)
- I304 (B)
- I316 (B)



Cierre central entre persianas/
Central latch between shutters/
Fermeture central entre volets



238/4691



238/2351

También hace función de aldabilla/
Also can be used as hook/
Également il fait fonction de crochet



Ref.238 Accesorios para españoleta - Espagnolette bolts accessories - Accessoires pour spagnolettes

Ref./Cod.	mm	Medidas Size Dimension	Características Characteristics Caractéristiques
238/4692	25x3x63		Tope para cementar / for brick work / à sceller
238/4693	25x4x51		Tope con tirafondo / screw fix / à vis
238/4694	25x3x38		Tope escuadra para atornillar/plate mount/ platine

Materiales- (Acabados) / Materials- (Treatments) / Matériaux- (Finitions)

- L (PU)
- I304 (B)
- I316 (B)

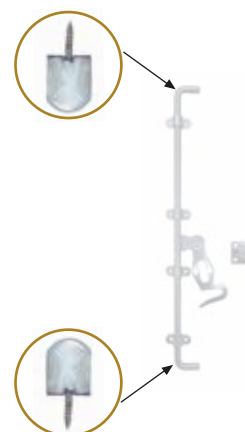

238/4692



238/4693



238/4694

HERRAJES PARA PÉRGOLAS

FITTINGS FOR PERGOLAS

FERRURES POUR PERGOLAS

PAG.198-205



Escuadra 90° - Bracket 90° - Équerre 90°

Ref.600

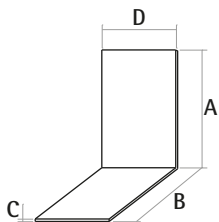

Ref./Cod.	mm Medidas / Size Dimension A x B x D x C	Detalles	
600/4060	90x90x65x2,5	Reforzada - Reinforced - Renforcée	25
600/4061	100x100x90x3	Reforzada - Reinforced - Renforcée	25
600/4062	90x90x65x2,5		25
600/4063	100x100x90x3		25

Materiales- (Acabados) / Materials- (Treatments) / Matériaux- (Finitions)

 (BRI) - (PA)

600/4060



600/4061



600/4062





600/4063

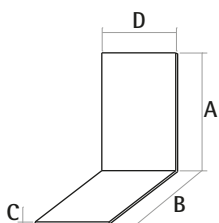

Escuadra 90° - Bracket 90° - Équerre 90°

Ref.600



Ref./Cod.	mm Medidas / Size Dimension A x B x D x C	Detalles	
600/4066	60x60x60x2		50
600/4067	80x80x60x2		50
600/4068	80x80x80x2		50
600/4160	55x55x125x3		48

Materiales- (Acabados) / Materials- (Treatments) / Matériaux- (Finitions)

 (BRI) - (PA)

600/4066





600/4067

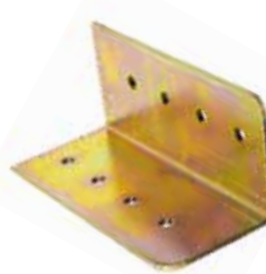

600/4160



Ref./Cod.	mm Medidas / Size Dimension A x B x D x C	Detalles	
600/4064	50x50x40x2		50
600/4065	90x90x40x2		50
600/4069	40x80x40x2		50
600/4070	40x140x40x2		50

Materiales- (Acabados) / Materials- (Treatments) / Matériaux- (Finitions)	
	(BRI) - (PA)

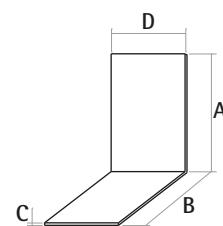

600/4064



600/4065





600/4069



600/4070



Ref./Cod.	mm Medidas / Size Dimension A x B x D x C	Detalles	
600/4071	90x90x65x2,5		25
600/4072	100x100x90x3		25
600/4073	50x50x40x2		50
600/4074	90x90x40x2		50

Materiales- (Acabados) / Materials- (Treatments) / Matériaux- (Finitions)	
	(BRI) - (PA)

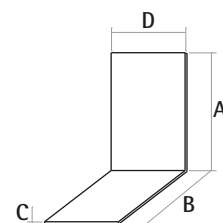

600/4071



600/4072



600/4073





600/4074

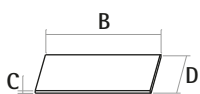

Placas unión planas (ensamblaje) - Flat plates - Platine plate

Ref.600



Ref./Cod.	mm	Medidas / Size Dimension B x D x C	Detalles	
600/4078	180	65x2,5		10
600/4079	200	90x3		10

Materiales- (Acabados) / Materials- (Treatments) / Matériaux- (Finitions)

H (BRI) - (PA)

600/4078





600/4079

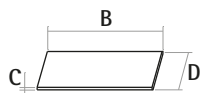

Placas unión planas (ensamblaje) - Flat plates - Platine plate

Ref.600



Ref./Cod.	mm	Medidas / Size Dimension B x D x C	Detalles	
600/4080	100	40x2		50
600/4081	180	40x2		50

Materiales- (Acabados) / Materials- (Treatments) / Matériaux- (Finitions)

H (BRI) - (PA)

600/4080



600/4081



Placas unión planas (ensamblaje) - Flat plates - Platine plate

Ref./Cod.	mm	Medidas / Size Dimension B x D x C	Detalles	
600/4075		160x40x2		50
600/4076		200x60x2		50
600/4077		200x80x2		50

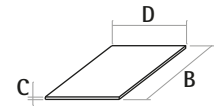

Materiales- (Acabados) / Materials- (Treatments) / Matériaux- (Finitions)

 (BRI) - (PA)

600/4066



600/4067



600/4160



Placa plana para base - Flat plates - Platine plate

Ref./Cod.	mm	Medidas / Size Dimension B x D x C	Detalles	
600/4161		155x155x3		10

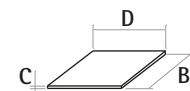

Materiales- (Acabados) / Materials- (Treatments) / Matériaux- (Finitions)

 (BRI) - (PA)

600/4161



Escuadras unión viga - Connectors/brackets - Connecteurs/équerres

Ref.600



Ref./Cod.	mm Medidas / Size Dimension Ax B x C	Detalles	
600/4082D	180x30x2	VARIANTE A DERECHAS	25
600/4082I	180x30x2	VARIANTE A IZQUIERDAS	25

Materiales- (Acabados) / Materials- (Treatments) / Matériaux- (Finitions)

H (BRI) - (PA)



Soportes viga - Supports - Support

Ref.600

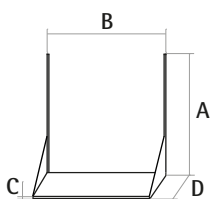

Ref./Cod.	mm Medidas / Size Dimension A x B x D x C	Detalles	
600/4087	86x80x75x2	Soporte viga cerrado	25
600/4088	108x100x75x2	Soporte viga cerrado	25
600/4089	108x100x75x2	Soporte viga abierto	25
600/4090	132x120x75x2	Soporte viga abierto	25

Materiales- (Acabados) / Materials- (Treatments) / Matériaux- (Finitions)

H (BRI) - (PA)

600/4087 - 600/4088



600/4089 - 600/4090



Soportes pilar - Column support - Support colonne

Ref./Cod.	mm Medidas / Size Dimension A x B x H x D x E x C	Detalles	
600/4084	70x70x130x155x155x3		10
600/4163	70x70x125x155x155x3		10
Materiales- (Acabados) / Materials- (Treatments) / Matériaux- (Finitions)			
H (BRI) - (PA)			

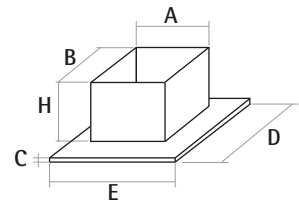

600/4084



600/4163



Soportes pilar - Column support - Support colonne

Ref./Cod.	mm Medidas / Size Dimension A x B x H x D x E x C	Detalles	
600/4162	65x65x160x125x125x3		10
600/4083	71x45x170x45x157x4		10
Materiales- (Acabados) / Materials- (Treatments) / Matériaux- (Finitions)			
H (BRI) - (PA)			

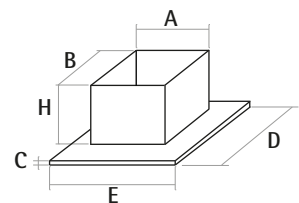



600/4084



600/4163

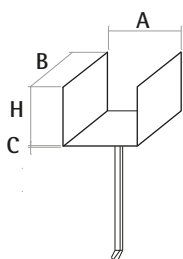



Ref./Cod.	mm Medidas / Size Dimension A x B x H x C	Detalles	
600/4085	71x70x123x3		10
600/4086	91x70x113x3		10

Materiales- (Acabados) / Materials- (Treatments) / Matériaux- (Finitions)

H (BRI) - (PA)

600/4085



600/4086





ACCESORIOS PARA CABINAS SANITARIAS

ACCESSORIES FOR TOILET CUBICLES

ACCESSOIRES POUR CABINES SANITAIRES

PAG.208-219



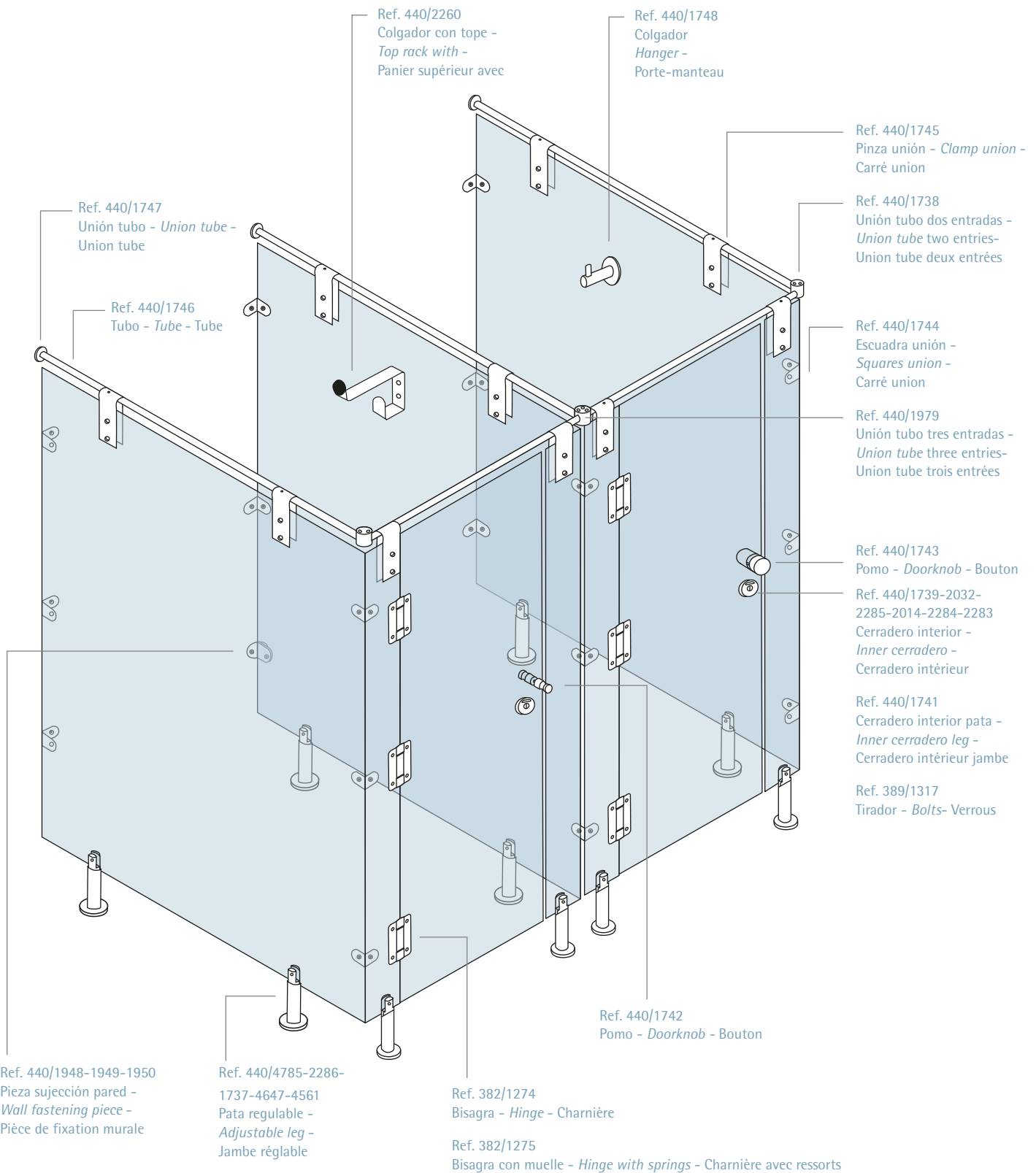

Ref.440

Pata regulable en altura - Adjustable leg - Jambe réglable

Ref./Cod.	mm Medidas Size Dimension	mm Medida tablero	Características Characteristics Caractéristiques
440/4785	Ø30x80	13	Regulación de 70 a 110 mm
440/2286	Ø30x120	10	Regulación de 110 a 160 mm
440/1737	Ø30x120	13	Regulación de 110 a 160 mm
440/4647	Ø30x120	19	Regulación de 110 a 160 mm
440/4561	Ø30x200	13	Regulación de 190 a 240 mm



Materiales- (Acabados) / Materials- (Treatments) / Matériaux- (Finitions)

I304 (SA)

I316 (SA)



Ref.440

Pinza unión tubo a tablero - Clamp union - Carré union

Ref./Cod.	mm Medidas Size Dimension	mm Medida tablero	mm Medida tubo
440/1745	40x3	13	Ø25



Materiales- (Acabados) / Materials- (Treatments) / Matériaux- (Finitions)

I304 (SA)

I316 (SA)



Ref.440

Unión de tubos - Union tube - Union tube

Ref./Cod.	mm Medidas Size Dimension	mm Medida tubo	Características Characteristics Caractéristiques
440/1738	40x50	Ø25	2 entradas
440/1979	40x50	Ø25	3 entradas



Materiales- (Acabados) / Materials- (Treatments) / Matériaux- (Finitions)

I304 (SA)

I316 (SA)

Ref. 440/1738



Ref. 440/1979



Soporte tubo a pared - *Wall fixing piece* - Fixation murale

Ref.440



Ref./Cod.	mm Medidas Size Dimension	mm Medida tubo
440/1747	Ø52	Ø25

Materiales- (Acabados) / Materials- (Treatments) / Matériaux- (Finitions)

I304 (SA)

I316 (SA)



Tubo para estructura de cabinas sanitarias - *Inox tube* - Tube en acier inox

Ref.440



Ref./Cod.	mm Medidas Size Dimension	Características Characteristics Caractéristiques
440/1746	Ø25x(1 espesor)	Longitud máx. 6 metros

Materiales- (Acabados) / Materials- (Treatments) / Matériaux- (Finitions)

I304 (SA)

I316 (SA)



Perfil en U/L para sujetar tableros - *U/L shaped inox profiles* - Profile en U/L

Ref.440

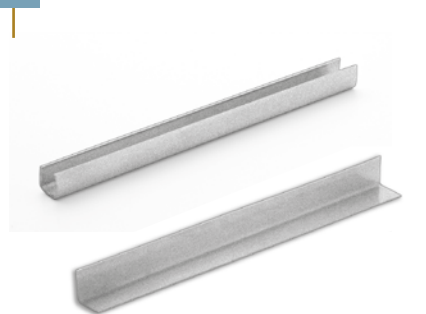

Ref./Cod.	mm Medidas Size Dimension	Características Characteristics Caractéristiques
440/2372	15x15x(1 espesor)	Perfil en U - Longitud máx. 6 metros
440/2373	20x20x(1,5 espesor)	Perfil en L - Longitud máx. 2 metros

Materiales- (Acabados) / Materials- (Treatments) / Matériaux- (Finitions)

I304 (SA)

I316 (SA)



Ref.440 **Soporte tablero doble escuadra - Double panel holder - Support panneaux double**

Ref./Cod.	mm Medidas Size Dimension	mm Medida tablero
440/1948	50x54,5x67x2	13

Materiales- (Acabados) / Materials- (Treatments) / Matériaux- (Finitions)	
I304	(SA)
I316	(SA)



Ref.440 **Soporte tablero escuadra - Panel holder in L-form - Support panneaux en L**

Ref./Cod.	mm Medidas Size Dimension	mm Medida tablero
440/1949	50x54,5x41,5x2	13

Materiales- (Acabados) / Materials- (Treatments) / Matériaux- (Finitions)	
I304	(SA)
I316	(SA)



Ref.440 **Soporte tablero en U - Panel holder in U-form - Support panneaux en U**

Ref./Cod.	mm Medidas Size Dimension	mm Medida tablero
440/1950	50x49,5x17x2	13

Materiales- (Acabados) / Materials- (Treatments) / Matériaux- (Finitions)	
I304	(SA)
I316	(SA)



Escuadra de unión canto romo - *Brackets* - Équerres

Ref.440



Ref./Cod.	mm Medidas Size Dimension
440/1744	50x50x3

Materiales- (Acabados) / *Materials- (Treatments)* / *Matériaux- (Finitions)*

I304 (SA)

I316 (SA)



Escuadra de unión - *Brackets* - Équerres

Ref.440



Ref./Cod.	mm Medidas Size Dimension	Características Characteristics Caractéristiques
440/4594	50x50x2	Con 2 embuticiones de refuerzo

Materiales- (Acabados) / *Materials- (Treatments)* / *Matériaux- (Finitions)*

I304 (SA)

I316 (SA)



Placa doble unión tableros - *Connecting plates kit* - Plaque de connexion

Ref.440



Ref./Cod.	mm Medidas Size Dimension	mm Medida tablero
440/2589	50x67x2	13

Materiales- (Acabados) / *Materials- (Treatments)* / *Matériaux- (Finitions)*

I304 (SA)

I316 (SA)



Pinza sujeta-cristales - *Glass support* - Pince à verre

Ref.440



Ref./Cod.	mm Medidas Size Dimension	mm Medida cristal	Características Characteristics Caractéristiques
440/1802	40x50x10	8/10 mm	Para tubos Ø43mm

Materiales- (Acabados) / *Materials- (Treatments)* / *Matériaux- (Finitions)*

I316 (PUE)



Ref.440 Cerradero pata varilla curvada - Bathroom turn/indicator set - Bouton de condamnation

Ref./Cod.	mm Medidas Size Dimension	mm Medida tablero	Características Characteristics Caractéristiques
440/2285	Ø52		

Materiales- (Acabados) / Materials- (Treatments) / Matériaux- (Finitions)	
1304	(SA)



Ref.440 Cerradero pata varilla recta - Bathroom turn/indicator set - Bouton de condamnation

Ref./Cod.	mm Medidas Size Dimension	mm Medida tablero	Características Characteristics Caractéristiques
440/2032	Ø52		

Materiales- (Acabados) / Materials- (Treatments) / Matériaux- (Finitions)	
1304	(SA)



Ref.440 Cerradero pata plana con tope - Bathroom turn/indicator set - Bouton de condamnation

Ref./Cod.	mm Medidas Size Dimension	mm Medida tablero	Características Characteristics Caractéristiques
440/2284	Ø62		

Materiales- (Acabados) / Materials- (Treatments) / Matériaux- (Finitions)	
1304	(SA)
1316	(SA)



Cerradero pata plana - Bathroom turn/indicator set - Bouton de condamnation

Ref.440



Ref./Cod.	mm	Medidas Size Dimension
440/2014		Ø62

Materiales- (Acabados) / Materials- (Treatments) / Matériaux- (Finitions)

I304 (SA)



Cerradero pata - Bathroom turn/indicator set - Bouton de condamnation

Ref.440



Ref./Cod.	mm	Medidas Size Dimension	Características Characteristics Caractéristiques
440/1741		Ø52	Soporte interno Inox.
440/2283		Ø52	Soporte interno Aluminio

Materiales- (Acabados) / Materials- (Treatments) / Matériaux- (Finitions)

I304 (SA)

I316 (SA)



Cerradero pomo - Bathroom turn/indicator set - Bouton de condamnation

Ref.440



Ref./Cod.	mm	Medidas Size Dimension
440/1739		Ø52

Materiales- (Acabados) / Materials- (Treatments) / Matériaux- (Finitions)

I304 (SA)

I316 (SA)



Ref.440

Conjunto pomo pequeño - *Door knob* - Bouton de porte

Ref./Cod.	mm Medidas Size Dimension	mm Medida tablero
440/1742	Ø25x42	Máx. 15mm

Materiales- (Acabados) / *Materials- (Treatments)* / Matériaux- (Finitions)

I304 (SA)

I316 (SA)



Ref.440

Conjunto pomo grande - *Door knob* - Bouton de porte

Ref./Cod.	mm Medidas Size Dimension
440/1743	Ø50x50

Materiales- (Acabados) / *Materials- (Treatments)* / Matériaux- (Finitions)

I304 (SA)

I316 (SA)



Ref.389

Cerrojo para puerta - *Door bolt* - Verrous

Ref./Cod.	mm Medidas Size Dimension
389/1317	50

Materiales- (Acabados) / *Materials- (Treatments)* / Matériaux- (Finitions)

I304 (SA)



Colgadores Chapa - *Metallic Hangers - Porte-manteu*

Ref.469



Ref./Cod.	mm	Medidas Size Dimension	Características Characteristics Caractéristiques
469/2974		20x2,5x65	Colgador simple / <i>Single hanger</i> / Porte-manteu simple
469/2975		20x2,5x152	Colgador Doble / <i>Double hanger</i> / Porte-manteu double

Materiales- (Acabados) / *Materials- (Treatments) / Matériaux- (Finitions)*

I304 (SA)



Colgador con tope - *Hanger with door stopper - Porte-manteau avec bouchon*

Ref.440



Ref./Cod.	mm	Medidas Size Dimension	Características Characteristics Caractéristiques
440/2260		75x69x18,5x2,5	Con tope para puerta

Materiales- (Acabados) / *Materials- (Treatments) / Matériaux- (Finitions)*

I304 (SA)



Colgador con tope - *Hanger with door stopper - Porte-manteau avec bouchon*

Ref.440



Ref./Cod.	mm	Medidas Size Dimension	Características Characteristics Caractéristiques
440/2433		Ø52x95	Con tope para puerta

Materiales- (Acabados) / *Materials- (Treatments) / Matériaux- (Finitions)*

I304 (SA)

I316 (SA)



Colgador - *Hanger - Porte-manteau*

Ref.440



Ref./Cod.	mm	Medidas Size Dimension
440/1748		Ø52

Materiales- (Acabados) / *Materials- (Treatments) / Matériaux- (Finitions)*

I304 (SA)

I316 (SA)



Ref.382 **Bisagras planas para puerta fenólica - Flat hinges for toilet cubicles - Charnières**

Ref./Cod.	mm Medidas Size Dimension	Características Characteristics Caractéristiques
382/1274	90x52x2	Sin muelle
382/1275	90x52x2	Con muelle

Materiales- (Acabados) / Materials- (Treatments) / Matériaux- (Finitions)	
1304	(SA)
1316	(SA)



Ref.382 **Bisagra solapada con muelle - Cranked hinges with spring - Charnières à ressort**

Ref./Cod.	mm Medidas Size Dimension
382/1273	90x48x2

Materiales- (Acabados) / Materials- (Treatments) / Matériaux- (Finitions)	
1304	(SA)



Ref.575 **Bisagra con muelle - Spring hinges - Charnières à ressort**

Ref./Cod.	mm Medidas Size Dimension
575/2930	100x70x2,5

Materiales- (Acabados) / Materials- (Treatments) / Matériaux- (Finitions)	
1304	(SA)

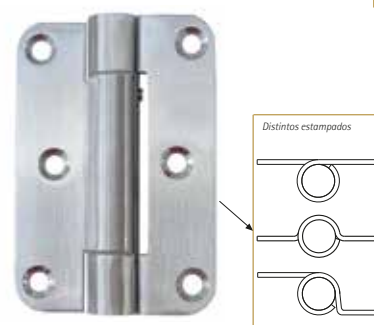

Bisagras planas para puerta fenólica - Flat hinges for toilet cubicles - Charnières

Ref.153



Ref./Cod.	mm	Medidas Size Dimension	Características Characteristics Caractéristiques
153/845	75x55x2,5		Bisagra con arandelas

Materiales- (Acabados) / Materials- (Treatments) / Matériaux- (Finitions)

I304 (SA)

I316 (SA)



Pernios planos para puerta fenólica - Butt hinges for toilet cubicles - Paumelles

Ref.139



Ref./Cod.	mm	Medidas Size Dimension	Características Characteristics Caractéristiques
139/192 PLANA	90x65x2,5		Plana con mano Derecha o Izquierda

Materiales- (Acabados) / Materials- (Treatments) / Matériaux- (Finitions)

I304 (SA)

I316 (SA)



Tornillos pasantes para cabinas - Passing screws for booths - Vis passagères pour les cabins

Ref.440



Ref./Cod.	mm	Medidas / Size Dimension Ø x L
440/2331		Ø6x10 - Tornillo M5
440/2332		Ø6x14 - Tornillo M5
440/2333		Ø6x16 - Tornillo M5

Materiales- (Acabados) / Materials- (Treatments) / Matériaux- (Finitions)

I304 (B)

Tornillos para cabinas DIN7983 - Screws for booths DIN7983 - Vis pour les cabins DIN7983

Ref.260



Ref./Cod.	mm	Medidas / Size Dimension Ø x L
260/2767		Ø3,5x13 - DIN7983
260/2437		Ø4,8x13 - DIN7983

Materiales- (Acabados) / Materials- (Treatments) / Matériaux- (Finitions)

I304 (B)

Ref.260 Tornillos para fijación de bisagras - *Hinge-fastening screws* - Vis pour fixation de charnières

Ref./Cod.	d	D	P. máx.	Longitud (L) Length Longueur
260/424	2.5	5	1.2	12
260/425	3	6	1.8	16
260/426	3.5	7	2.1	20
260/427	4	8	2.4	25



Materiales- (Acabados) / Materials- (Treatments) / Matériaux- (Finitions)

H (BRI)

I304 (B)



Ref.261 Clavos para fijación de bisagras y accesorios - *Hinge-fastening nails and accessories* - Clous pour fixation de charnières et accessoires

Ref./Cod.	mm Clavos Nails Clous	T
(A) 261/430	1x10	
(B) 261/431	1x10	



Materiales- (Acabados) / Materials- (Treatments) / Matériaux- (Finitions)

H Ref. 261/430: (LA)

L Ref. 261/431: (B)



Ref.262 Arandelas autoengrasables - *Washers lubricated* - Rondelles lubrifié

Ref./Cod.	mm Medidas/ Size/Dimension A x B x C	Ref./Cod.	mm Medidas/ Size/Dimension A x B x C
262/432	12x7x3	262/435	16x10x3
262/433	13x7x3	262/436	16x10x4
262/434	15x10x3	262/437	9x5x2,5

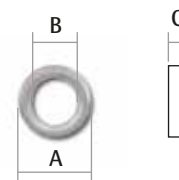

Materiales- (Acabados) / Materials- (Treatments) / Matériaux- (Finitions)

I303

I316



Nuestros productos en la red

Como ya habrán podido comprobar, disponemos de una página web actualizada, donde podrán ver fotografías y datos de nuestros productos.

Desde su buscador y sus potentes filtros, pueden encontrar rápidamente la bisagra que mejor se adapte a sus necesidades.

Our products online

As you may have noticed, we have recently updated our website. You'll now find product photos and additional data.

The product filters will also help you find the article which better meets your requirements.

Nos produits sur Internet

Comme vous l'avez probablement déjà constaté, notre site Internet a été récemment mis à jour. Vous y trouverez des photos et des données de nos produits.

Les filtres de produit vont vous aider à trouver les articles qui répondent le mieux à vos besoins.



www.metalurgiapons.com



Metalurgia Pons.LIM S.L.

Av. Industria - P 5
Polígono La Trotxa
Ap. Correos 3
07730 Alaior (Menorca)
Islas Baleares (España)

Tel. (34) 971 37 10 69 - 37 10 52 - 37 20 58

Móvil: (34) 646 001 496

Fax (34) 971 37 28 60 - 37 23 31

e-mail: pons@metalurgiapons.com

www.metalurgiapons.com