

IMECA[®]
INDUSTRIAS

CATÁLOGO GENERAL



Pol. Ind. El Secano - C/ Chulilla, 5 - 46174 DOMENYO - Valencia - España
Tel. 96 272 80 84 - Fax 96 272 80 87 - e-mail: info@industriasimeca.com

www.industriasimeca.com



INDUSTRIAS METÁLICAS CASINENSES, S.L.,

somos una empresa fundada en 1987. Gracias a nuestro esfuerzo por crecer y superarnos hemos conseguido establecernos como una empresa referente en los mercados nacionales e internacionales del sector del cercado.

Actualmente contamos con unas instalaciones y maquinaria de última generación, que nos permiten optimizar los procesos de fabricación y ser competitivos en todos los productos de nuestra amplia gama.

El sistema de gestión de calidad avalado por la norma ISO-9001 garantiza la calidad y el servicio más elevado a nuestros clientes.

Gracias por seguir confiando en nuestra empresa.

is a company founded in 1987. Thanks to our efforts to grow and excel, we have managed to establish ourselves as a leading company in the national and international fencing sector markets.

Currently, we have the latest machinery and excellent facilities, which allow us to optimize the manufacturing processes and to be competitive in our wide range of products.

The quality management system according to the ISO 9001 standard allows us to provide our customers with the highest quality and service.

Thank you for your trust in our company.

est une entreprise créée en 1987. Grâce à nos efforts pour croître et exceller, nous avons réussi à nous établir comme une entreprise de référence dans les marchés nationaux et internationaux du secteur de la clôture.

Actuellement, nous avons des plus modernes machines et d'excellentes installations, ce qui nous permet d'optimiser le processus de fabrication et d'être compétitifs dans tous les produits de notre large éventail de produits.

Le système de gestion de la qualité certifié ISO 9001 garantit à nos clients la plus haute qualité et service.

Merci pour compter sur notre entreprise.

empresa



instalaciones



productos

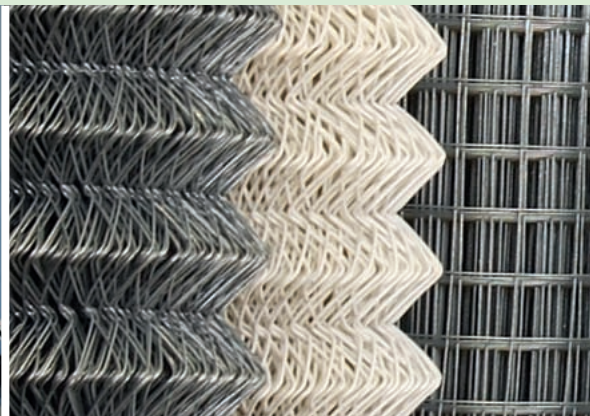





●	Puertas para cercado <i>Fence gates / Portes de clôture</i>	
●	Abatibles <i>Folding doors / À battant</i>	6
●	Correderas <i>Sliding doors / Coulissantes</i>	8
■	Puertas y paneles <i>Doors and panels / Portes et panneaux</i>	10
	Tapa para arquetas <i>Irrigation pit covers / Couvertcles pour chambres à vannes</i>	12
■	Postes para cercados <i>Fence posts / Poteaux pour clôtures</i>	
●	Rectos <i>Straight / Droits</i>	14
●	Rectos con brida tensora <i>Straight posts / Poteaux droits</i>	16
●	Curvos <i>Curved / Courbes</i>	18
●	De sujeción cuadrados y rectangulares <i>Square and rectangular fixing / De fixation carrés et rectangulaires</i>	20
●	Bases con acople <i>Base with coupling / Plaque base avec coupleur</i>	22
●	Acoples para alambre de espino <i>Couplings for barbed wire / Coupleurs pour fil de fer barbelé</i>	22
●	De sujeción redondos <i>Round fixing / De fixation ronds</i>	23
●	Para viñedos y accesorios <i>Vineyard poles and accessories / Poteaux de palissage et accessoires</i>	23
■	Mallas <i>Wire mesh / Grillages</i>	26
	Alambres <i>Wires / Fils de fer</i>	28
	Herramientas de instalación <i>Installation tools / Outils d'installation</i>	29
■	Accesorios para postes <i>Posts accessories / Accessoires pour poteaux</i>	
●	Bridas <i>Flanges / Brides</i>	32
●	Tapas metálicas <i>Metal covers / Bouchons métalliques</i>	34
●	Tapas P.E. negro para tubos metálicos <i>Black EPS lids for metal tubes / Bouchons de PE noirs pour tubes métalliques</i>	35
●	Pletinas y tirantes <i>Plates and stays / Plats et tirants</i>	36
●	Tensores, tornillería y anclajes <i>Tensors, screws and anchors / Tendeurs, visserie et ancrages</i>	37
●	Placas y uñas <i>Metal plates and toes / Plaques et griffes</i>	38
■	Accesorios para puertas correderas <i>Sliding doors accessories / Accessoires pour portes coulissantes</i>	42
	Cierres y cerrojos <i>Locks and bolts / Fermetures et verroux</i>	43
	Pernios y asas <i>Hinges and handle / Paumelles et anses</i>	44
	Pasadores y piquetas camping <i>Pins and tent pegs / Goupilles et piquets</i>	45
	Tendederos <i>Clotheslines / Séchoirs</i>	46



PUERTAS PARA CERCADO

Fence gates

Portes de clôture



PUERTAS PARA CERCADO. ABATIBLES

Fence gates. Folding doors / Portes de clôture. Portes à battant

●●●● Puerta de mallazo de 1 hoja *Wire mesh gate, one leaf / Porte grillagée à battant*



ANCHO x ALTO (mm)
Length x Height (mm)
Longueur x Hauteur (mm)
865 x 1000
865 x 1200
865 x 1500
865 x 2000

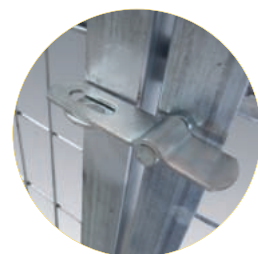

Cierre balancín

Clamping lever lock
Fermeture à balancier

●●●● Puerta de mallazo de 2 hojas

Wire mesh gate, double leaf / Porte grillagée à deux battants

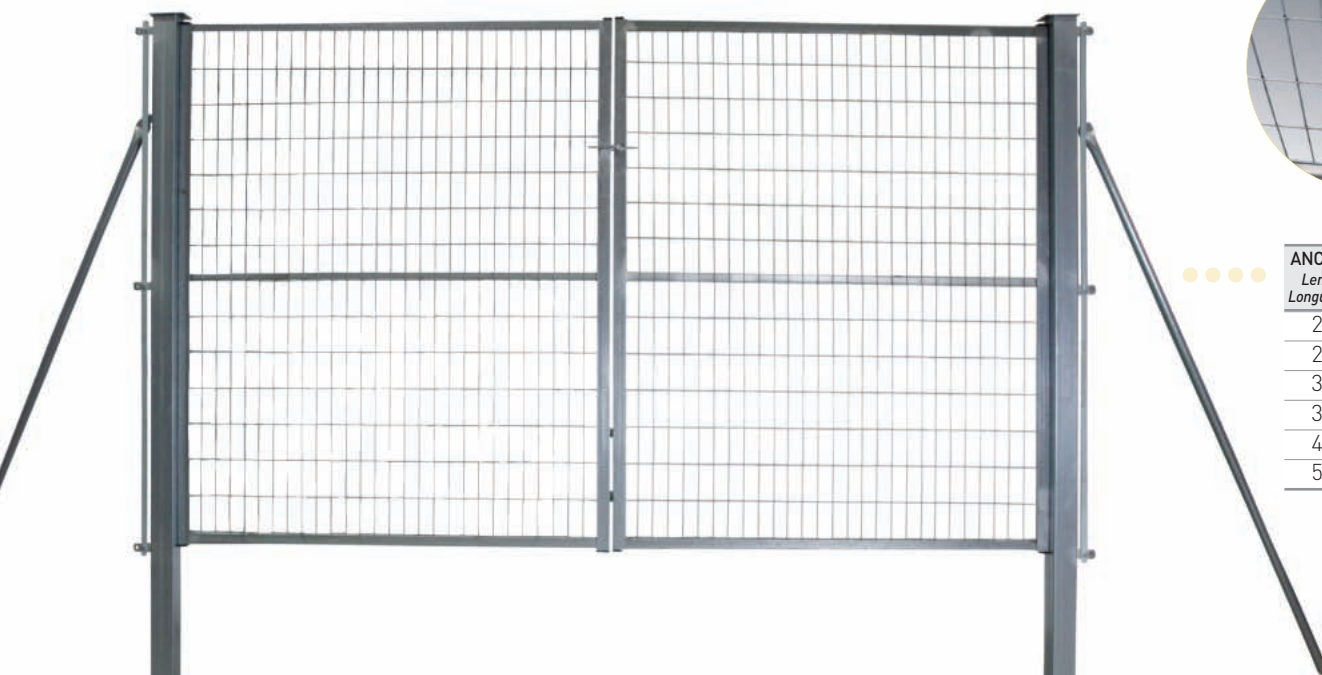

ANCHO x ALTO (mm)
Length x Height (mm)
Longueur x Hauteur (mm)
2000 x 1500
2000 x 2000
3000 x 1500
3000 x 2000
4000 x 2000
5000 x 2000



■ Completas con pasamanos y tirantes tornapuntas.





Complete with handrails and stays / Complètes avec main courante et tirants

●●●● Puerta de malla plegada de 1 hoja *Folded wire mesh gate, one leaf / Porte grillagée pliée à battant*



ANCHO x ALTO (mm) Length x Height (mm) Longueur x Hauteur (mm)
865 x 1000
865 x 1200
865 x 1500
865 x 2000

■ Acabados:
Finishes/finitions:

- Galvanizado
Galvanized
Galvanisé 
- Verde RAL 6005
Green RAL 6005
Vert RAL 6005 
- Blanco RAL 9010
White RAL 9010
Blanc RAL 9010 
- Azul RAL 5010
Blue RAL 5010
Bleu RAL 5010 

●●●● Puerta de malla plegada de 2 hojas *Wire mesh gate, double leaf / Porte grillagée à deux battants*



Cierre balancín
Clamping lever lock
Fermeture à balancier



Cerradura con manivela opcional
Complete with handrails and stays
Complètes avec main courante et tirants

ANCHO x ALTO (mm) Length x Height (mm) Longueur x Hauteur (mm)
2000 x 1500
2000 x 2000
3000 x 1500
3000 x 2000
4000 x 2000
5000 x 2000



PUERTAS PARA CERCADO. CORREDERAS

Fence gates. Sliding doors / Portes de clôture. Portes coulissantes

●●●● De mallazo *Wire mesh / Grillagées*

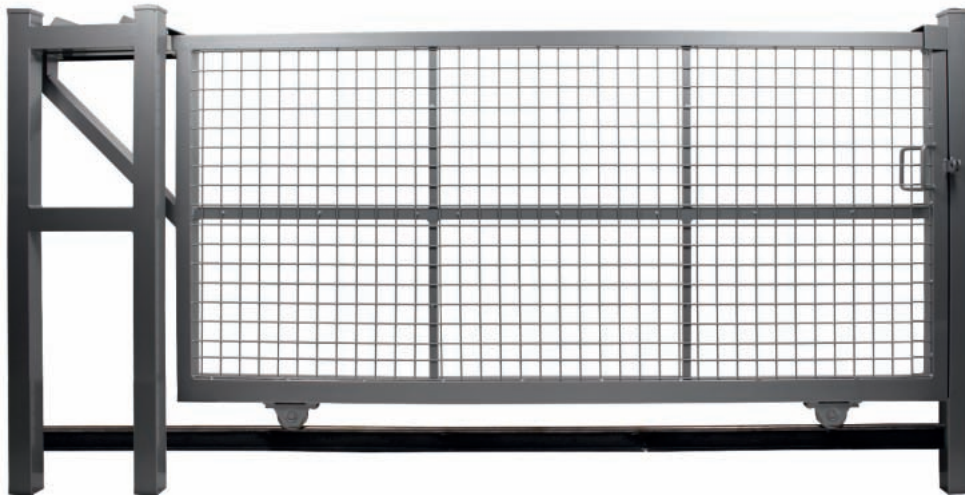

●●●● De malla plegada *Folded mesh / Grillagées pliées*

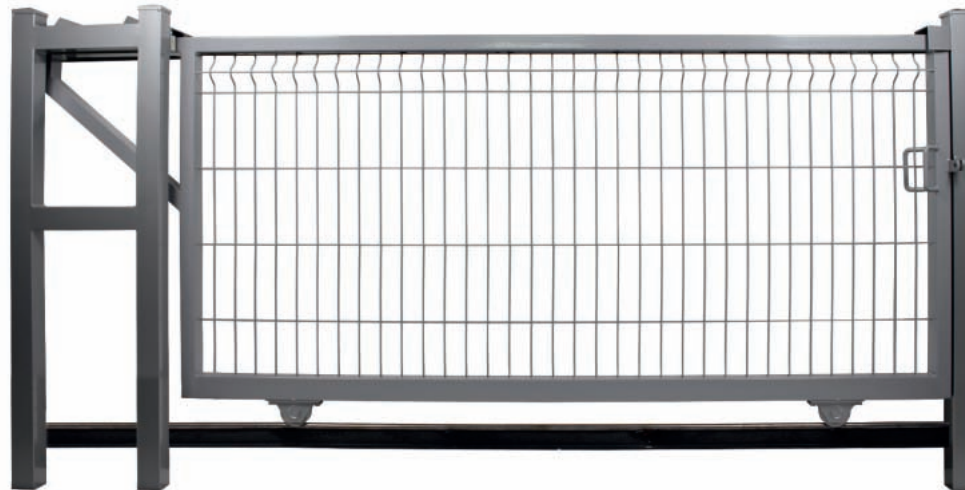

●●●● Embarrotadas *With bars / Avec barreaux verticaux*



ANCHO x ALTO (mm)
Length x Height (mm)
Longueur x Hauteur (mm)
3000 x 2000
4000 x 2000
5000 x 2000
6000 x 2000
7000 x 2000
8000 x 2000
9000 x 2000
10000 x 2000

■ Acabados: Finishes/finitions:

Galvanizado
Galvanized
Galvanisé



Verde RAL 6005
Green RAL 6005
Vert RAL 6005



Blanco RAL 9010
White RAL 9010
Blanc RAL 9010



Azul RAL 5010
Blue RAL 5010
Bleu RAL 5010



Todos los modelos se fabrican bajo pedido *All the models are produced on request / Tous les modèles sont fabriqués sur commande*



PUERTAS Y PANELES

Doors and panels / Portes et panneaux

TAPAS PARA ARQUETAS

Irrigation pit covers

Couvercles pour chambres à vannes



●●●● Puertas y paneles de chapa perforada

Perforated sheet gates and panels / Portes et panneaux de tôle perforée



ANCHO x ALTO (mm) Length x Height (mm) Longueur x Hauteur (mm)	REFERENCIA Reference Référence
1000 x 1000	-15010001000G
1000 x 1500	-15010001500G
1000 x 2000	-15010002000G



ANCHO x ALTO (mm) Length x Height (mm) Longueur x Hauteur (mm)	REFERENCIA Reference Référence
2000 x 2000	-25020002000G
3000 x 2000	-25030002000G
4000 x 2000	-25040002000G



ANCHO x ALTO (mm) Length x Height (mm) Longueur x Hauteur (mm)	REFERENCIA Reference Référence
500 x 1000	21205001000G
1000 x 1000	21210001000G
1500 x 1000	21215001000G
2000 x 1000	21220001000G

ANCHO x ALTO (mm) Length x Height (mm) Longueur x Hauteur (mm)	REFERENCIA Reference Référence
60 x 1250	222606015250G



●●●● **Paneles de mallazo enmarcado**
Framed mesh panels / Panneaux grillagés encadrés



Panel *Panel / Panneaux*

ANCHO x ALTO (mm) Length x Height (mm) Longueur x Hauteur (mm)	REFERENCIA Référence Référence
2600 x 1800	292260018003
2600 x 1500	292260015003

Poste *Post / Poteaux*

ALTO (mm) Height (mm) Hauteur (mm)	REFERENCIA Référence Référence
1800	302404018003
1500	302404015003

●●●● **Barandilla embarrotada** *Bar Rail / Balustrade avec barreaux verticaux*



ANCHO x ALTO (mm) Length x Height (mm) Longueur x Hauteur (mm)
1000 x 1000
1500 x 1000
2000 x 1000





TAPAS PARA ARQUETAS

Irrigation pit covers / Couvertres pour chambres à vannes

●●●● Chapa lisa *Flat plate / Tôle lisse*

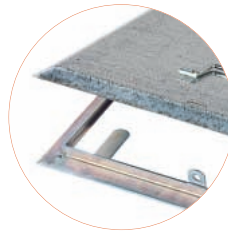

ANCHO x ALTO (mm) Length x Height (mm) Longueur x Hauteur (mm)	REFERENCIA Reference Référence
300 x 300	1511030003000
400 x 400	1511040004000
500 x 500	1511050005000
600 x 600	1511060006000
700 x 700	1511070007000
800 x 800	1511080008000
900 x 900	1511090009000
1000 x 1000	1511100010000

●●●● Chapa estriada / plana *Treadplate / flat – Tôle larmée / plate*

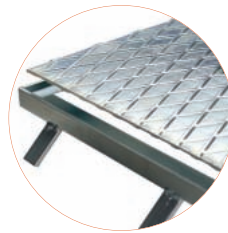

ANCHO x ALTO (mm) Length x Height (mm) Longueur x Hauteur (mm)	REFERENCIA Reference Référence
300 x 300	1512030003000
400 x 400	1512040004000
500 x 500	1512050005000
600 x 600	1512060006000
700 x 700	1512070007000
800 x 800	1512080008000
900 x 900	1512090009000
1000 x 1000	1512100010000

●●●● Chapa estriada / resaltada *Treadplate / highlighted – Tôle larmée / rehaussée*

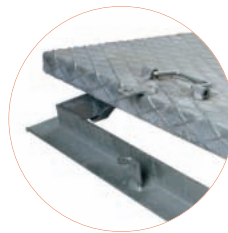

ANCHO x ALTO (mm) Length x Height (mm) Longueur x Hauteur (mm)	REFERENCIA Reference Référence
300 x 300	1513030003000
400 x 400	1513040004000
500 x 500	1513050005000
600 x 600	1513060006000
700 x 700	1513070007000
800 x 800	1513080008000
900 x 900	1513090009000
1000 x 1000	1513100010000

●●●● Chapa tipo rejilla *Grid type plate / Grillagée*

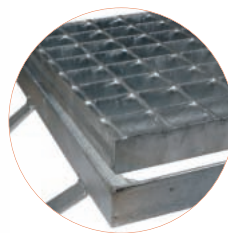

ANCHO x ALTO (mm) Length x Height (mm) Longueur x Hauteur (mm)	REFERENCIA Reference Référence
300 x 300	1514030003000
400 x 400	1514040004000
500 x 500	1514050005000
600 x 600	1514060006000
700 x 700	1514070007000
800 x 800	1514080008000
900 x 900	1514090009000
1000 x 1000	1514100010000

Todos los modelos se fabrican bajo pedido *All the models are produced on request / Tous les modèles sont fabriqués sur commande*

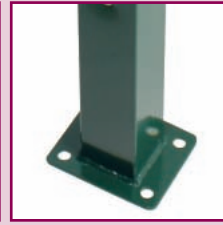

POSTES PARA CERCADOS

Fence posts

Poteaux pour clôtures



POSTES RECTOS

Straight posts / Poteaux droits

Principio *Beginning / Extrême*



Sentido izquierdo *Left / À gauche*

DIMENSIONES (mm) <i>Dimensions (mm)</i>	ALTURA MALLA (mm) <i>Mesh height (mm) Hauteur grillage (mm)</i>	GALVANIZADO <i>Galvanized Galvanisé</i>
Ø 48 x 1250	1000	9011600481250
Ø 48 x 1450	1200	9011600481450
Ø 48 x 1800	1500	9011600481800
Ø 48 x 2400	2000	9011600482400
		PVC VERDE <i>PVC Green PVC Vert</i>
Ø 48 x 1250	1000	9011600481252
Ø 48 x 1450	1200	9011600481452
Ø 48 x 1800	1500	9011600481802
Ø 48 x 2400	2000	9011600482402



Sentido derecho *Right / À droite*

DIMENSIONES (mm) <i>Dimensions (mm)</i>	ALTURA MALLA (mm) <i>Mesh height (mm) Hauteur grillage (mm)</i>	GALVANIZADO <i>Galvanized Galvanisé</i>
Ø 48 x 1250	1000	9011100481250
Ø 48 x 1450	1200	9011100481450
Ø 48 x 1800	1500	9011100481800
Ø 48 x 2400	2000	9011100482400
		PVC VERDE <i>PVC Green PVC Vert</i>
Ø 48 x 1250	1000	9011100481252
Ø 48 x 1450	1200	9011100481452
Ø 48 x 1800	1500	9011100481802
Ø 48 x 2400	2000	9011100482402

Con brida IMECA
*With IMECA flange
Avec bride IMECA*

Intermedio *Intermediate / Intermédiaire*



DIMENSIONES (mm) <i>Dimensions (mm)</i>	ALTURA MALLA (mm) <i>Mesh height (mm) Hauteur grillage (mm)</i>	GALVANIZADO <i>Galvanized Galvanisé</i>
Ø 48 x 1250	1000	9011200481250
Ø 48 x 1450	1200	9011200481450
Ø 48 x 1800	1500	9011200481800
Ø 48 x 2400	2000	9011200482400
		PVC VERDE <i>PVC Green PVC Vert</i>
Ø 48 x 1250	1000	9011200481252
Ø 48 x 1450	1200	9011200481452
Ø 48 x 1800	1500	9011200481802
Ø 48 x 2400	2000	9011200482402

■ Fabricados con tubos Ø 48 x 1'2
*Made with Ø 48 x 1'2 tubes
Fabriqués avec tube Ø 48 x 1'2*

●●●● Centro de tensión *Centre / Renfort*

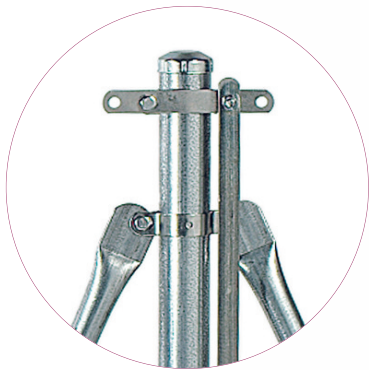

Con brida IMECA
With IMECA flange
Avec bride IMECA

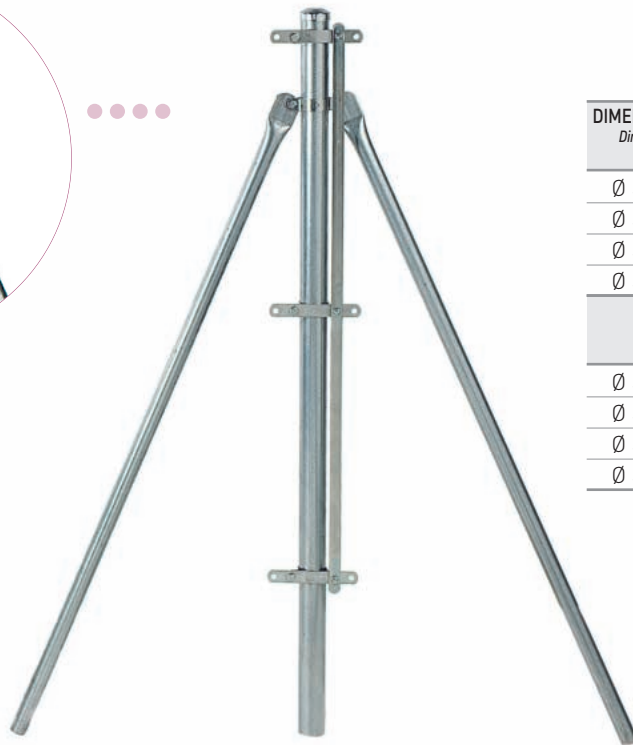

DIMENSIONES (mm) <i>Dimensions (mm)</i>	ALTURA MALLA (mm) <i>Mesh height (mm)</i> <i>Hauteur grillage (mm)</i>	GALVANIZADO <i>Galvanized</i> <i>Galvanisé</i>
Ø 48 x 1250	1000	9011300481250
Ø 48 x 1450	1200	9011300481450
Ø 48 x 1800	1500	9011300481800
Ø 48 x 2400	2000	9011300482400
		PVC VERDE <i>PVC Green</i> <i>PVC Vert</i>
Ø 48 x 1250	1000	9011300481252
Ø 48 x 1450	1200	9011300481452
Ø 48 x 1800	1500	9011300481802
Ø 48 x 2400	2000	9011300482402

●●●● Esquinero *Corner / Angle*

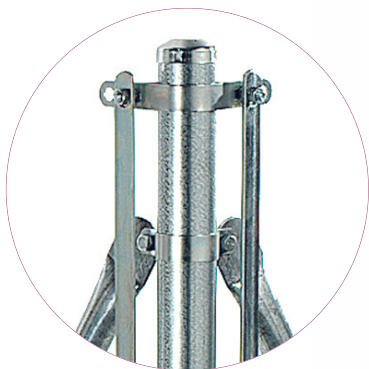

Con brida IMECA
With IMECA flange
Avec bride IMECA



DIMENSIONES (mm) <i>Dimensions (mm)</i>	ALTURA MALLA (mm) <i>Mesh height (mm)</i> <i>Hauteur grillage (mm)</i>	GALVANIZADO <i>Galvanized</i> <i>Galvanisé</i>
Ø 48 x 1250	1000	9011400481250
Ø 48 x 1450	1200	9011400481450
Ø 48 x 1800	1500	9011400481800
Ø 48 x 2400	2000	9011400482400
		PVC VERDE <i>PVC Green</i> <i>PVC Vert</i>
Ø 48 x 1250	1000	9011400481252
Ø 48 x 1450	1200	9011400481452
Ø 48 x 1800	1500	9011400481802
Ø 48 x 2400	2000	9011400482402



POSTES RECTOS CON BRIDA TENSORA

Straight posts / Poteaux droits

Principio tensor *Tensor on top / Tendeur au début*



DIMENSIONES (mm) <i>Dimensions (mm)</i>	ALTURA MALLA (mm) <i>Mesh height (mm)</i> <i>Hauteur grillage (mm)</i>	GALVANIZADO <i>Galvanized</i> <i>Galvanisé</i>
Ø 48 x 1250	1000	9011800481250
Ø 48 x 1450	1200	9011800481450
Ø 48 x 1800	1500	9011800481800
Ø 48 x 2400	2000	9011800482400
		PVC VERDE <i>PVC Green</i> <i>PVC Vert</i>
Ø 48 x 1250	1000	9011800481252
Ø 48 x 1450	1200	9011800481452
Ø 48 x 1800	1500	9011800481802
Ø 48 x 2400	2000	9011800482402

Intermedio *Intermediate / Intermédiaire*

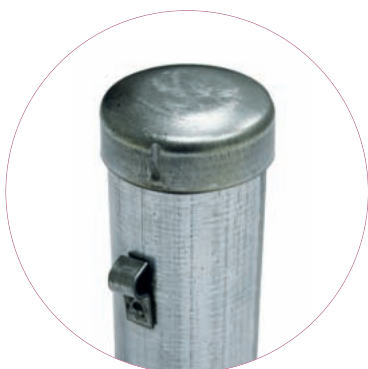

DIMENSIONES (mm) <i>Dimensions (mm)</i>	ALTURA MALLA (mm) <i>Mesh height (mm)</i> <i>Hauteur grillage (mm)</i>	GALVANIZADO <i>Galvanized</i> <i>Galvanisé</i>
Ø 48 x 1250	1000	9011200481250
Ø 48 x 1450	1200	9011200481450
Ø 48 x 1800	1500	9011200481800
Ø 48 x 2400	2000	9011200482400
		PVC VERDE <i>PVC Green</i> <i>PVC Vert</i>
Ø 48 x 1250	1000	9011200481252
Ø 48 x 1450	1200	9011200481452
Ø 48 x 1800	1500	9011200481802
Ø 48 x 2400	2000	9011200482402

■ Fabricados con tubos Ø 48 x 1'2

Made with Ø 48 x 1'2 tubes

Fabriqués avec tube Ø 48 x 1'2

●●●● Centro tensor *Tensing centre / Renfort*

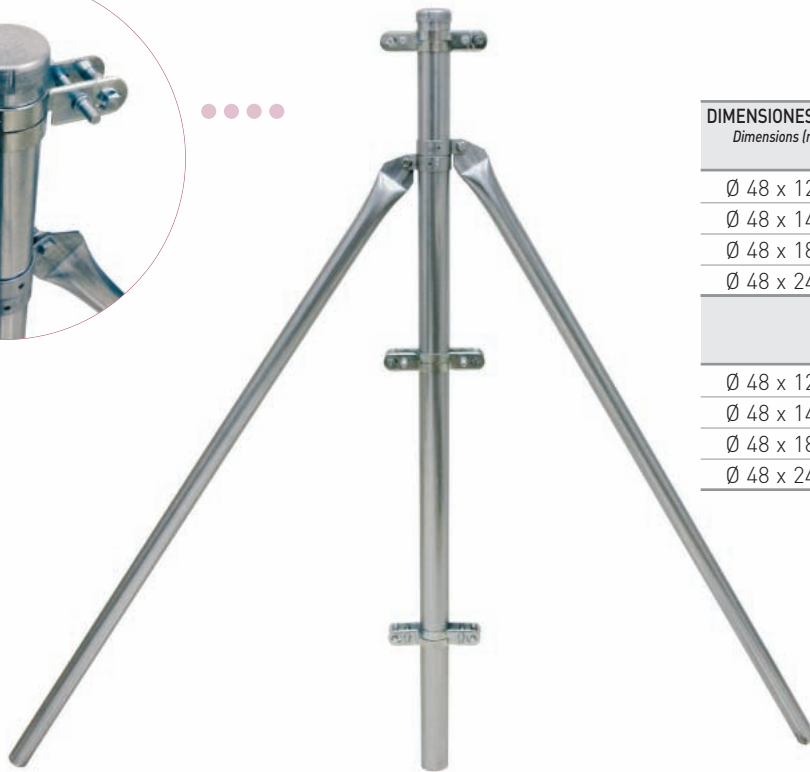

DIMENSIONES (mm) <i>Dimensions (mm)</i>	ALTURA MALLA (mm) <i>Mesh height (mm)</i> <i>Hauteur grillage (mm)</i>	GALVANIZADO <i>Galvanized</i> <i>Galvanisé</i>
Ø 48 x 1250	1000	9011900481250
Ø 48 x 1450	1200	9011900481450
Ø 48 x 1800	1500	9011900481800
Ø 48 x 2400	2000	9011900482400
		PVC VERDE <i>PVC Green</i> <i>PVC Vert</i>
Ø 48 x 1250	1000	9011900481252
Ø 48 x 1450	1200	9011900481452
Ø 48 x 1800	1500	9011900481802
Ø 48 x 2400	2000	9011900482402

●●●● Esquinero tensor *Tensing corner / Angle*

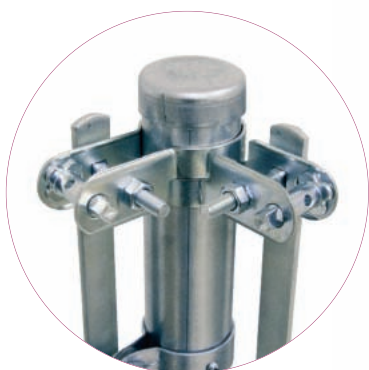

DIMENSIONES (mm) <i>Dimensions (mm)</i>	ALTURA MALLA (mm) <i>Mesh height (mm)</i> <i>Hauteur grillage (mm)</i>	GALVANIZADO <i>Galvanized</i> <i>Galvanisé</i>
Ø 48 x 1250	1000	9011110481250
Ø 48 x 1450	1200	9011110481450
Ø 48 x 1800	1500	9011110481800
Ø 48 x 2400	2000	9011110482400
		PVC VERDE <i>PVC Green</i> <i>PVC Vert</i>
Ø 48 x 1250	1000	9011110481252
Ø 48 x 1450	1200	9011110481452
Ø 48 x 1800	1500	9011110481802
Ø 48 x 2400	2000	9011110482402



POSTES CURVOS

Curved posts / Poteaux courbes

Principio *Beginning / Extrême*



Sentido izquierdo *Left / À gauche*

DIMENSIONES (mm) <i>Dimensions (mm)</i>	ALTURA MALLA (mm) <i>Mesh height (mm) Hauteur grillage (mm)</i>	GALVANIZADO <i>Galvanized Galvanisé</i>
Ø 48 x 1650	1000	9031600481650
Ø 48 x 1850	1200	9031600481850
Ø 48 x 2200	1500	9031600482200
Ø 48 x 2800	2000	9031600482800
		PVC VERDE <i>PVC Green PVC Vert</i>
Ø 48 x 1650	1000	9031600481652
Ø 48 x 1850	1200	9031600481852
Ø 48 x 2200	1500	9031600482202
Ø 48 x 2800	2000	9031600482802



Sentido derecho *Right / À droite*

DIMENSIONES (mm) <i>Dimensions (mm)</i>	ALTURA MALLA (mm) <i>Mesh height (mm) Hauteur grillage (mm)</i>	GALVANIZADO <i>Galvanized Galvanisé</i>
Ø 48 x 1650	1000	9031100481650
Ø 48 x 1850	1200	9031100481850
Ø 48 x 2200	1500	9031100482200
Ø 48 x 2800	2000	9031100482800
		PVC VERDE <i>PVC Green PVC Vert</i>
Ø 48 x 1650	1000	9031100481652
Ø 48 x 1850	1200	9031100481852
Ø 48 x 2200	1500	9031100482202
Ø 48 x 2800	2000	9031100482802

Intermedio *Intermediate / Intermédiaire*



DIMENSIONES (mm) <i>Dimensions (mm)</i>	ALTURA MALLA (mm) <i>Mesh height (mm) Hauteur grillage (mm)</i>	GALVANIZADO <i>Galvanized Galvanisé</i>
Ø 48 x 1650	1000	9031200481650
Ø 48 x 1850	1200	9031200481850
Ø 48 x 2200	1500	9031200482200
Ø 48 x 2800	2000	9031200482800
		PVC VERDE <i>PVC Green PVC Vert</i>
Ø 48 x 1650	1000	9031200481652
Ø 48 x 1850	1200	9031200481852
Ø 48 x 2200	1500	9031200482202
Ø 48 x 2800	2000	9031200482802

●●●● Centro de tensión *Centre / Renfort*



DIMENSIONES (mm) <i>Dimensions (mm)</i>	ALTURA MALLA (mm) <i>Mesh height (mm)</i> <i>Hauteur grillage (mm)</i>	GALVANIZADO <i>Galvanized</i> <i>Galvanisé</i>
Ø 48 x 1650	1000	9031300481650
Ø 48 x 1850	1200	9031300481850
Ø 48 x 2200	1500	9031300482200
Ø 48 x 2800	2000	9031300482800
		PVC VERDE <i>PVC Green</i> <i>PVC Vert</i>
Ø 48 x 1650	1000	9031300481652
Ø 48 x 1850	1200	9031300481852
Ø 48 x 2200	1500	9031300482202
Ø 48 x 2800	2000	9031300482802

●●●● Esquinero *Corner / Angle*



DIMENSIONES (mm) <i>Dimensions (mm)</i>	ALTURA MALLA (mm) <i>Mesh height (mm)</i> <i>Hauteur grillage (mm)</i>	GALVANIZADO <i>Galvanized</i> <i>Galvanisé</i>
Ø 48 x 1650	1000	9031400481650
Ø 48 x 1850	1200	9031400481850
Ø 48 x 2200	1500	9031400482200
Ø 48 x 2800	2000	9031400482800
		PVC VERDE <i>PVC Green</i> <i>PVC Vert</i>
Ø 48 x 1650	1000	9031400481652
Ø 48 x 1850	1200	9031400481852
Ø 48 x 2200	1500	9031400482202
Ø 48 x 2800	2000	9031400482802

■ Preparado para tres alambres. Indicar al realizar el pedido curvos o rectos.

Ready for three wires. Please specify curved or straight when ordering / Préparé pour trois fils de fer. Préciser courbe ou droite à la commande



POSTES DE SUJECCIÓN CUADRADOS/RECTANGULARES

Square and rectangular fixing posts / Poteaux de fixation carrés et rectangulaires

●●●● Postes cuadrados. Con placa y sin placa

Square posts. With board and without board

Poteaux carrés. Avec plaque et sans plaque



Lisos Smooth / Lisses

DIMENSIONES (mm) Dimensions (mm)	ALTURA MALLA (mm) Mesh height (mm) Hauteur grillage (mm)	GALVANIZADO Galvanized Galvanisé	VERDE RAL 6005 Green Ral 6005 Vert Ral 6005	BLANCO RAL 9010 White Ral 9010 Blanc Ral 9010
60 x 60 x 1,5 x 1050	1000	9112-60601050	9112-60601052	9112-60601053
60 x 60 x 1,5 x 1250	1200	9112-60601250	9112-60601252	9112-60601253
60 x 60 x 1,5 x 1550	1500	9112-60601550	9112-60601552	9112-60601553
60 x 60 x 1,5 x 2050	2000	9112-60602050	9112-60602052	9112-60602053

Lisos Smooth / Lisses

DIMENSIONES (mm) Dimensions (mm)	ALTURA MALLA (mm) Mesh height (mm) Hauteur grillage (mm)	GALVANIZADO Galvanized Galvanisé	VERDE RAL 6005 Green Ral 6005 Vert Ral 6005	BLANCO RAL 9010 White Ral 9010 Blanc Ral 9010
60 x 60 x 1,5 x 1250	1000	9012-60601250	9012-60601252	9012-60601253
60 x 60 x 1,5 x 1450	1200	9012-60601450	9012-60601452	9012-60601453
60 x 60 x 1,5 x 1800	1500	9012-60601800	9012-60601802	9012-60601803
60 x 60 x 1,5 x 2400	2000	9012-60602400	9012-60602402	9012-60602403



Mecanizados Mechanized / Mécanisés

DIMENSIONES (mm) Dimensions (mm)	ALTURA MALLA (mm) Mesh height (mm) Hauteur grillage (mm)	GALVANIZADO Galvanized Galvanisé	VERDE RAL 6005 Green Ral 6005 Vert Ral 6005	BLANCO RAL 9010 White Ral 9010 Blanc Ral 9010
60 x 60 x 1,5 x 1050	1000	9112060601050	9112060601052	9112060601053
60 x 60 x 1,5 x 1250	1200	9112060601250	9112060601252	9112060601253
60 x 60 x 1,5 x 1550	1500	9112060601550	9112060601552	9112060601553
60 x 60 x 1,5 x 2050	2000	9112060602050	9112060602052	9112060602053

Mecanizados Mechanized / Mécanisés

DIMENSIONES (mm) Dimensions (mm)	ALTURA MALLA (mm) Mesh height (mm) Hauteur grillage (mm)	GALVANIZADO Galvanized Galvanisé	VERDE RAL 6005 Green Ral 6005 Vert Ral 6005	BLANCO RAL 9010 White Ral 9010 Blanc Ral 9010
60 x 60 x 1,5 x 1250	1000	9012060601250	9012060601252	9012060601253
60 x 60 x 1,5 x 1450	1200	9012060601450	9012060601452	9012060601453
60 x 60 x 1,5 x 1800	1500	9012060601800	9012060601802	9012060601803
60 x 60 x 1,5 x 2400	2000	9012060602400	9012060602402	9012060602403



●●●● Postes rectangulares. Con placa y sin placa

Rectangular posts. With board and without board

Poteaux rectangulaires. Avec plaque et sans plaque

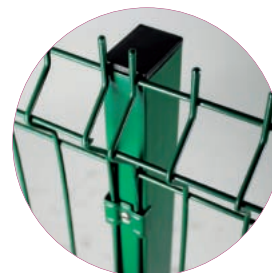

Lisos Smooth / Lisses

DIMENSIONES (mm) Dimensions (mm)	ALTURA MALLA (mm) Mesh height (mm) Hauteur grillage (mm)	GALVANIZADO Galvanized Galvanisé	VERDE RAL 6005 Green Ral 6005 Vert Ral 6005	BLANCO RAL 9010 White Ral 9010 Blanc Ral 9010
60 x 40 x 1,5 x 1050	1000	9113-60401050	9113-60401052	9113-60401053
60 x 40 x 1,5 x 1250	1200	9113-60401250	9113-60401252	9113-60401253
60 x 40 x 1,5 x 1550	1500	9113-60401550	9113-60401552	9113-60401553
60 x 40 x 1,5 x 2050	2000	9113-60402050	9113-60402052	9113-60402053

Lisos Smooth / Lisses

DIMENSIONES (mm) Dimensions (mm)	ALTURA MALLA (mm) Mesh height (mm) Hauteur grillage (mm)	GALVANIZADO Galvanized Galvanisé	VERDE RAL 6005 Green Ral 6005 Vert Ral 6005	BLANCO RAL 9010 White Ral 9010 Blanc Ral 9010
60 x 40 x 1,5 x 1250	1000	9013-60401250	9013-60401252	9013-60401253
60 x 40 x 1,5 x 1450	1200	9013-60401450	9013-60401452	9013-60401453
60 x 40 x 1,5 x 1800	1500	9013-60401800	9013-60401802	9013-60401803
60 x 40 x 1,5 x 2400	2000	9013-60402400	9013-60402402	9013-60402403

Mecanizados Mechanized / Mécanisés

DIMENSIONES (mm) Dimensions (mm)	ALTURA MALLA (mm) Mesh height (mm) Hauteur grillage (mm)	GALVANIZADO Galvanized Galvanisé	VERDE RAL 6005 Green Ral 6005 Vert Ral 6005	BLANCO RAL 9010 White Ral 9010 Blanc Ral 9010
60 x 40 x 1,5 x 1050	1000	9113060401050	9113060401052	9113060401053
60 x 40 x 1,5 x 1250	1200	9113060401250	9113060401252	9113060401253
60 x 40 x 1,5 x 1550	1500	9113060401550	9113060401552	9113060401553
60 x 40 x 1,5 x 2050	2000	9113060402050	9113060402052	9113060402053

Mecanizados Mechanized / Mécanisés

DIMENSIONES (mm) Dimensions (mm)	ALTURA MALLA (mm) Mesh height (mm) Hauteur grillage (mm)	GALVANIZADO Galvanized Galvanisé	VERDE RAL 6005 Green Ral 6005 Vert Ral 6005	BLANCO RAL 9010 White Ral 9010 Blanc Ral 9010
60 x 40 x 1,5 x 1250	1000	9013060401250	9013060401252	9013060401253
60 x 40 x 1,5 x 1450	1200	9013060401450	9013060401452	9013060401453
60 x 40 x 1,5 x 1800	1500	9013060401800	9013060401802	9013060401803
60 x 40 x 1,5 x 2400	2000	9013060402400	9013060402402	9013060402403



BASES CON ACOPLE

Base with coupling / Plaque base avec coupleur

Base con acople para tubo cuadrado 60 x 60

Base with coupling for 60 x 60 square tube
Plaque base avec coupleur pour tube carré 60 x 60



GALVANIZADO Galvanized Galvanisé	VERDE RAL 6005 Green Ral 6005 Vert. Ral 6005	BLANCO RAL 9010 White Ral 9010 Blanc Ral 9010	
0507212012040	0507212012042	0507212012043	20

Base con acople para tubo rectangular 60 x 40

Base with coupling for 60 x 40 square tube
Plaque base avec coupleur pour tube carré 60 x 40



GALVANIZADO Galvanized Galvanisé	VERDE RAL 6005 Green Ral 6005 Vert. Ral 6005	BLANCO RAL 9010 White Ral 9010 Blanc Ral 9010	
0506212012040	0506212012042	0506212012043	20

Fijación F60

F60 Fixing / Fixation F60



GALVANIZADO Galvanized Galvanisé	VERDE RAL 6005 Green Ral 6005 Vert. Ral 6005	BLANCO RAL 9010 White Ral 9010 Blanc Ral 9010	
0402002000	0402002002	0402002003	250

Fijación F40

F40 Fixing / Fixation F40



GALVANIZADO Galvanized Galvanisé	VERDE RAL 6005 Green Ral 6005 Vert. Ral 6005	BLANCO RAL 9010 White Ral 9010 Blanc Ral 9010	
0402003000	0402003002	0402003003	250



ACOPLES PARA ALAMBRE DE ESPINO

Couplings for barbed wire / Coupleurs pour fil de fer barbelé

Simple Single / simple

Doble Double / Double



DIMENSIONES (mm) Dimensions (mm)	VERDE RAL 6005 Green Ral 6005 Vert. Ral 6005
60 x 60	3616060pt252
60 x 40	3616040pt252

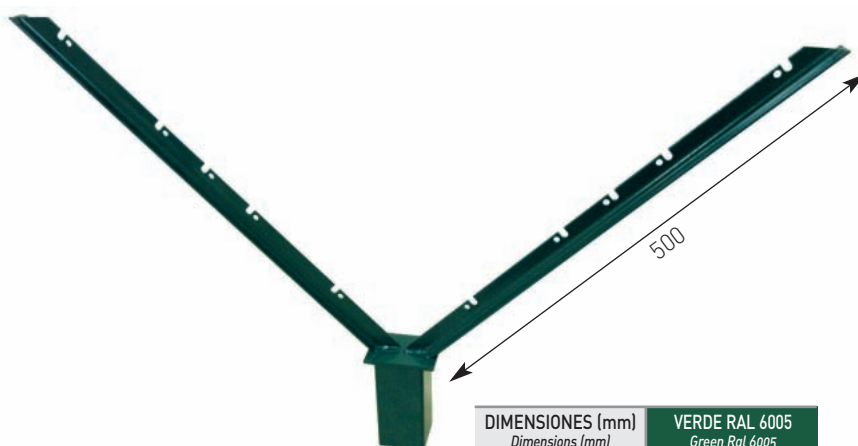

DIMENSIONES (mm) Dimensions (mm)	VERDE RAL 6005 Green Ral 6005 Vert. Ral 6005
60 x 60	3626060pt252
60 x 40	3626040pt252

Unidades por embalaje
Pieces per pack / Unités par emballage

POSTES DE SUJECIÓN REDONDOS

Round fixing posts / Poteaux de fixation ronds

Con placa / sin placa

With board / Without board
Avec plaque / Sans plaque



DIMENSIONES (mm) Dimensions (mm)	ALTURA MALLA (mm) Mesh height (mm) Hauteur grillage (mm)
Ø 48 x 1050	1000
Ø 48 x 1250	1200
Ø 48 x 1550	1500
Ø 48 x 2050	2000

DIMENSIONES (mm) Dimensions (mm)	ALTURA MALLA (mm) Mesh height (mm) Hauteur grillage (mm)
Ø 48 x 1250	1000
Ø 48 x 1450	1200
Ø 48 x 1800	1500
Ø 48 x 2400	2000



Base con acople para tubo Ø 48

Base with coupling for Ø 48 tube
Plaque base avec coupleur pour tube Ø 48



Spray pintura

Spray paint / Spray peinture



12

POSTES PARA VIÑEDO Y ACCESORIOS

Vineyard poles and accessories / Poteaux de palissage et accessoires



Principio

Beginning / Extrême



Medidas a consultar
Sizes to be consulted
Mesures à consulter



Intermedio

Intermediate / Intermédiaire

Hélices

Helix type / Ancrage type hélice

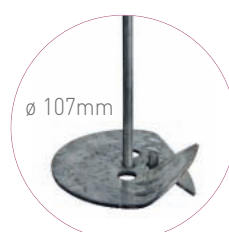

DIMENSIONES (mm) Dimensions (mm)	GALVANIZADO Galvanized Galvanisé
Ø 107	201077000



Tensores

Tensors / Tendeurs



DIMENSIONES (mm) Dimensions (mm)	GALVANIZADO Galvanized Galvanisé	
90 x 30 / 1,5	06019030150	225

mallas

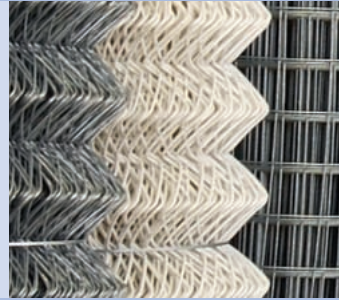
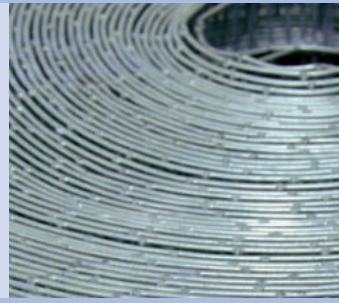

alambres

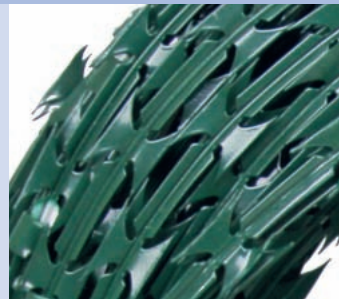
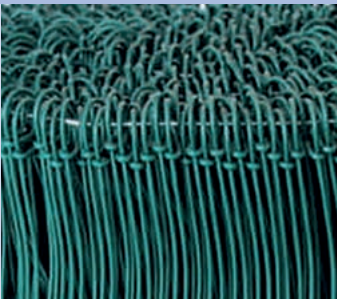

herramientas de instalación

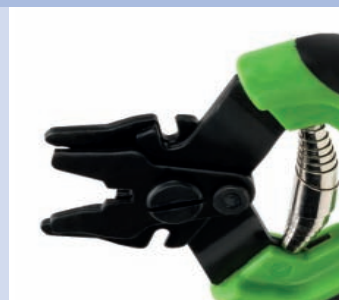

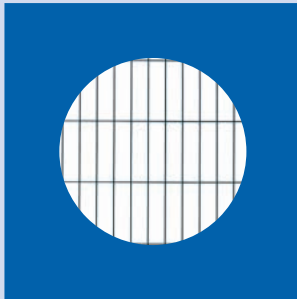

MALLAS

Wire mesh / Grillages

ALAMBRES

Wires / Fil de fer

HERRAMIENTAS DE INSTALACIÓN

Installation tools / Outils d'installation



●●●● **Malla plegada** *Folded mesh / Grillage pliée*

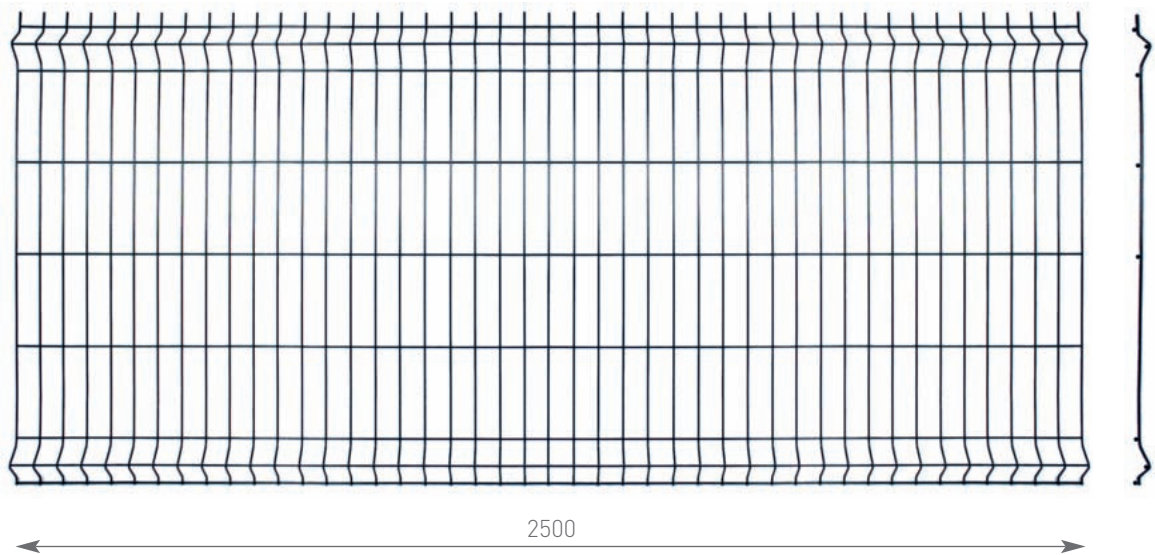

Malla Plegada 5 mm *Folded mesh 5mm / Grillage pliée 5mm*

DIMENSIONES (mm) <i>Dimensions (mm)</i>	GALVANIZADO <i>Galvanized Galvanisé</i>	VERDE RAL 6005 <i>Green Ral 6005 Vert Ral 6005</i>	BLANCO RAL 9010 <i>White Ral 9010 Blanc Ral 9010</i>
2500 x 600	0211060025000	0211060025002	0211060025003
2500 x 1000	0211100025000	0211100025002	0211100025003
2500 x 1200	0211120025000	0211120025002	0211120025003
2500 x 1500	0211150025000	0211150025002	0211150025003
2500 x 2000	0211200025000	0211200025002	0211200025003

Malla Plegada Brico 4 mm *Folded mesh Brico 4mm / Grillage pliée Brico 4mm*

DIMENSIONES (mm) <i>Dimensions (mm)</i>	GALVANIZADO <i>Galvanized Galvanisé</i>	VERDE RAL 6005 <i>Green Ral 6005 Vert Ral 6005</i>	BLANCO RAL 9010 <i>White Ral 9010 Blanc Ral 9010</i>
2500 x 600	0261060025000	0261060025002	0261060025003
2500 x 1000	0261100025000	0261100025002	0261100025003
2500 x 1200	0261120025000	0261120025002	0261120025003
2500 x 1500	0261150025000	0261150025002	0261150025003
2500 x 2000	0261200025000	0261200025002	0261200025003



•••• Simple torsión *Simply twisted mesh / Grillage simple torsion*



Galvanizada *Galvanized / Galvanisé*

ALTURA (mm) Height (mm) Hauteur (mm)	AGUJERO Hole Trou	ALAMBRE Wire Fil de fer	REFERENCIA Reference Référence
1000	50	14	0223100000000
1200	50	14	0223120000000
1500	50	14	0223150000000
2000	50	14	0223200000000

Plastificada verde *Laminated green / Plastifiée verte*

ALTURA (mm) Height (mm) Hauteur (mm)	AGUJERO Hole Trou	ALAMBRE Wire Fil de fer	REFERENCIA Reference Référence
1000	50	14 / 17	0224100000002
1200	50	14 / 17	0223120000002
1500	50	14 / 17	0224150000002
2000	50	14 / 17	0224200000002

•••• Ganadera-cinegética *Cattle and cynegetic mesh / Grillage pour élevage et activités cynégétiques*



ALTURA (mm) Height (mm) Hauteur (mm)	HILOS HORIZONTALES Horizontal wires Fils horizontals	DISTANCIA VERTICAL Distance between verticals Séparation entre verticaux	REFERENCIA Reference Référence
1000	8	30	171000830100
1000	8	15	171000815100
1530	12	30	171531230100
1530	12	15	171531215100
2000	20	30	172002030100
2000	20	15	172002015100

•••• Malla electrosoldada *Welded mesh / Grillage soudé*

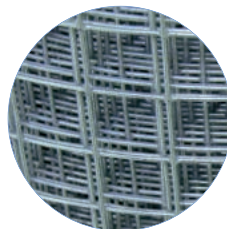

ALTURA (mm) Height (mm) Hauteur (mm)	AGUJERO Hole Trou	ALAMBRE Wire Fil de fer	REFERENCIA Reference Référence
1000	6 x 6	0,6	0231100006060
1000	13 x 13	0,9	0231100013130
1000	19 x 19	0,9	0231100019190
1000	25 x 25	1,6	0231100025250
1000	50 x 50	2	0231100050500

•••• Malla triple torsión *Triple torsion mesh / Grillage triple torsion*

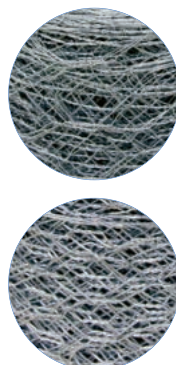

ALTURA (mm) Height (mm) Hauteur (mm)	AGUJERO Hole Trou	ALAMBRE Wire Fil de fer	REFERENCIA Reference Référence
1000	13	0,7	0251100000130
1000	19	0,75	0251100000190
1000	31	0,8	0251100000310
1000	51	0,9	0251100000510



ALAMBRES

Wires / Fil de fer

Alambre de anillas, haz de 1000.

Ring wire, bundle of 1000
Fil de fer à anneaux, faisceau 1000

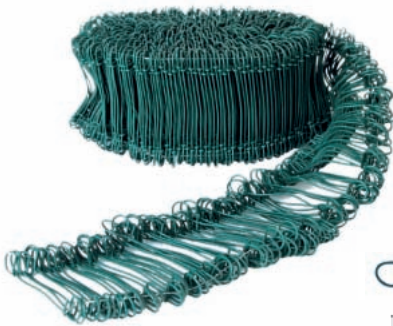

DIMENSIONES (mm) Dimensions (mm)	RECOCIDO Annealed / Recuit
1,1 x 100	1611010010006
1,1 x 120	1611012010006
1,1 x 160	1611016010006
1,1 x 200	1611020010006
	GALVANIZADO Galvanized / Galvanisé
1,1 x 120	1611012010000
1,2 x 160	1612016010000
	PVC VERDE PVC Green / PVC Vert
1,45 x 160	1614516010002

Concertina

Concertina mesh / Concertina

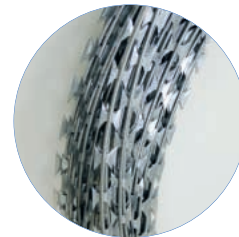

Consultar tipo de cuchilla
y diámetro
Blade type and diameter
to be consulted
Type de lame et diamètre
à consulter

Alambre recocido

Annealed wire / Fil de fer recuit



METROS Meters Mètres	PESO (kg) Weight (kg) Poids (kg)	REFERENCIA Reference Référence
8	5	030108100506
10	5	030110100506

Alambre de espino

Barbed wire / Fil de fer barbelé



METROS Meters Mètres	REFERENCIA Reference Référence
100	030200100000
250	030200200000

Alambre liso

Plain wires / Fil de fer lisse



CALIBRE	PESO (kg) Weight (kg) Poids (kg)	REFERENCIA Reference Référence
8	5	030108100500
10	5	030110100500
16	5	030116100500
14/17	5	030114100502

Alambre fino para atar

Fine wire to tie / Fil de fer mince pour ficeler



CALIBRE	PESO (kg) Weight (kg) Poids (kg)	REFERENCIA Reference Référence
6	1	030106100100
8	1	030108100100
10	1	030110100100
12	1	030112100100
14	1	030114100100
2/7	1	030107100100
6/11	1	030111100100

Otros calibres consultar
Other calibres to be consulted / Autres calibres à consulter



HERRAMIENTAS DE INSTALACIÓN

Installation tools / Outils d'installation

●●●● Grapadora 20, con cargador

Wire stapler 20, with loader
Agrafeuse pour grillage 20 avec chargeur

130200000000-



Tipo de grapa
Staple type
Type de agrafe
OMEGA 20



●●●● Grapadora 16/18, con cargador

Wire stapler 16/18, with loader
Agrafeuse pour grillage 16/18 avec chargeur

130300000000-



Tipo de grapa
Staple type
Type de agrafe
OMEGA 16-18



●●●● Grapadora 16/18/20, sin cargador

Wire stapler 16/18/20, without loader
Agrafeuse pour grillage 16/18/20 sans chargeur

130500000000-



Tipo de grapa
Staple type / Type de agrafe
OMEGA 16-18-20



●●●● Grapadora 29

Wire stapler 29
Agrafeuse pour grillage 29

130400000000-



Tipo de grapa
Staple type / Type de agrafe
CL 29 RINGS



●●●● Grapas Staples / Agrafes



Unidades por embalaje
Pieces per pack / Unités par emballage

MODELO Model Modèle	GALVANIZADO Galvanized Galvanisé	VERDE RAL 6005 Green Ral 6005 Vert Ral 6005	
OMEGA 16	1306011610000	1306011610002	1000
OMEGA 18	1306011810000	1306011810002	1000
OMEGA 20	1306012010000	1306012010002	1000
29	1306022910000	1306022910002	1000

●●●● Grampillones

U nails / Crampillons



1312000000000

4 kg



●●●● Tenaza multifunción

Multifunction pliers / Pinces multifonction



130800000000-

●●●● Tenaza rusa

Russian pliers / Tenaille russe



130900000000-

●●●● Tornado atador de alambre

Wire twister / Dispositif de liage pour fil de fer



130100000000-



Para cerrar bolsas, sacos, cercados, marcos para hormigón, etc
To close bags, sacks, fences, concrete frames, etc /
Pour fermer des sacs, des sachets, des clôtures, des cadres pour béton, etc

bridas



tapas



pletinas y tirantes



placas y uñas



tensores, tornilleria y anclajes





ACCESORIOS PARA POSTES

Post accessories

Accessoires pour poteaux



●●●● **Principio**
Beginning / Extrême



DIÁMETRO Diameter Diamètre	GALVANIZADO Galvanized Galvanisé	VERDE RAL 6005 Green Ral 6005 Vert Ral 6005	
45	0401101450	0401101452	150
48	0401101480	0401101482	150

●●●● **Tornapunta principio**
Top aligner / Support d'extrême



DIÁMETRO Diameter Diamètre	GALVANIZADO Galvanized Galvanisé	VERDE RAL 6005 Green Ral 6005 Vert Ral 6005	
33	0401201330	0401201332	300
40	0401201400	0401201402	300
42	0401201420	0401201422	300
45	0401201450	0401201452	200
48	0401201480	0401201482	200
50	0401201500	0401201502	200
60	0401201600	0401201602	150

●●●● **Esquinero**
Corner / Angle



DIÁMETRO Diameter Diamètre	GALVANIZADO Galvanized Galvanisé	VERDE RAL 6005 Green Ral 6005 Vert Ral 6005	
45	0401102450	0401102452	150
48	0401102480	0401102482	150

●●●● **Tornapunta esquinero**
Corner aligner / Support d'angle



DIÁMETRO Diameter Diamètre	GALVANIZADO Galvanized Galvanisé	VERDE RAL 6005 Green Ral 6005 Vert Ral 6005	
45	0401202450	0401202452	200
48	0401202480	0401202482	200

●●●● **Centro**
Centre / Centre



DIÁMETRO Diameter Diamètre	GALVANIZADO Galvanized Galvanisé	VERDE RAL 6005 Green Ral 6005 Vert Ral 6005	
33	0401103330	0401103332	150
45	0401103450	0401103452	150
48	0401103480	0401103482	150

●●●● **Tornapunta centro**
Centre aligner / Support centre



DIÁMETRO Diameter Diamètre	GALVANIZADO Galvanized Galvanisé	VERDE RAL 6005 Green Ral 6005 Vert Ral 6005	
33	0401203330	0401203332	200
45	0401203450	0401203452	200
48	0401203480	0401203482	200

•••• **Brida tensora rebajada**
Reduced tensing flange / Bride surbaissée



DIÁMETRO Diameter Diamètre	GALVANIZADO Galvanized Galvanisé	VERDE RAL 6005 Green Ral 6005 Vert Ral 6005	
48	0401109480	0401109482	150

•••• **Brida tensora**
Tensing flange / Bride tendeur



DIÁMETRO Diameter Diamètre	GALVANIZADO Galvanized Galvanisé	VERDE RAL 6005 Green Ral 6005 Vert Ral 6005	
48	0401108480	0401008482	150

•••• **Tornapunta esquinero invertido**
Inverted corner aligner / Support d'angle inverse



DIÁMETRO Diameter Diamètre	GALVANIZADO Galvanized Galvanisé	VERDE RAL 6005 Green Ral 6005 Vert Ral 6005	
45	0401204450	0401204452	100
48	0401204480	0401204482	100

•••• **Puente**
Bridge / Pont



DIÁMETRO Diameter Diamètre	GALVANIZADO Galvanized Galvanisé	VERDE RAL 6005 Green Ral 6005 Vert Ral 6005	
33	0401105330	0401105332	200
45	0401105450	0401105452	100
48	0401105480	0401105482	100

•••• **Esquinero invertido**
Inverted corner aligner / Angle inverse



DIÁMETRO Diameter Diamètre	GALVANIZADO Galvanized Galvanisé	VERDE RAL 6005 Green Ral 6005 Vert Ral 6005	
45	0401104450	0401104452	100
48	0401104480	0401104482	100





TAPAS METÁLICAS

Metal covers for posts / Bouchons métalliques pour poteaux

Redonda Round / Rond



DIMENSIONES (mm) Dimensions (mm)	REFERENCIA Reference / Référence	
Ø 34	0801010000340	1000
Ø 40	0801010000400	600
Ø 42	0801010000420	600
Ø 45	0801010000450	500
Ø 48	0801010120480	400
Ø 50	0801010000500	500
Ø 60	0801010000600	300
Ø 76	0801010000760	150
Ø 80	0801010000800	150
Ø 100	0801010001000	75

Con pestaña With flange / Avec rebord



DIMENSIONES (mm) Dimensions (mm)	REFERENCIA Reference / Référence	
Ø 34	0801110000340	500
Ø 40	0801110000400	400
Ø 42	0801110000420	350
Ø 45	0801110000450	300
Ø 48	0801110000480	300
Ø 50	0801110000500	300
Ø 60	0801110000600	200

Con hendidura en forma de cruz With cross-shaped slot / Avec fente en forme de croix



DIMENSIONES (mm) Dimensions (mm)	REFERENCIA Reference / Référence	
Ø 48	0802010000480	500
Ø 60	0802010000600	300
Ø 76	0802010000760	200
Ø 88	0802010000880	150

Sombrero para soldar Cap for welding / Chapeau pour souder



REFERENCIA Reference / Référence	
0803010000500	500

Cónica Conical / Conique



DIMENSIONES (mm) Dimensions (mm)	REFERENCIA Reference / Référence	
Ø 30	0804010000300	200
Ø 33	0804010000330	200
Ø 42	0804010000420	400
Ø 48	0804010000480	400
Ø 60	0804010000600	400
Ø 76	0804010000760	200
Ø 90	0804010000900	60
Ø 102	0804010001020	60
Ø 114	0804010001140	50

Cuadrada Square / Carré



DIMENSIONES (mm) Dimensions (mm)	REFERENCIA Reference / Référence	
20 x 20	0806010200200	100
30 x 30	0806010300300	100
40 x 40	0806010400400	100
50 x 50	0806010500500	100
60 x 60	0806010600600	100
80 x 80	0806010800800	50
100 x 100	0806011001000	50
120 x 120	0806011201200	50
150 x 150	0806011501500	50

Rectangular Rectangular / Rectangulaire

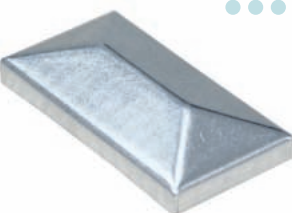

DIMENSIONES (mm) Dimensions (mm)	REFERENCIA Reference / Référence	
20 x 30	0807010200300	200
20 x 40	0807010200400	200
30 x 50	0807010300500	100
30 x 60	0807010300600	100
40 x 60	0807010400600	100
40 x 80	0807010400800	50
50 x 100	0807010501000	50





TAPAS P.E. NEGRO PARA TUBOS METÁLICOS

Black EPS lids for metal tubes / Bouchons PE noirs pour tubes métalliques

●●●● Redonda Round / Rond



DIMENSIONES (mm) Dimensions (mm)	REFERENCIA Reference / Référence	
20	0801020000204	500
30	0801020000304	250
35	0801020000354	200
40	0801020000404	200
42	0801020000424	200
45	0801020000454	150
48	0801020000484	150
50	0801020000504	150
60	0801020000604	100
80	0801020000804	50
100	0801020001004	25

●●●● Cuadrada Square / Carré



DIMENSIONES (mm) Dimensions (mm)	REFERENCIA Reference / Référence	
20 x 20	0806020200204	200
25 x 25	0806020250254	200
30 x 30	0806020300304	200
35 x 35	0806020350354	200
40 x 40	0806020400404	150
45 x 45	0806020450454	100
50 x 50	0806020500504	100
60 x 60	0806020600604	50
70 x 70	0806020700704	50
80 x 80	0806020800804	25
100 x 100	0806021001004	25

●●●● Rectangular Rectangular / Rectangulaire



DIMENSIONES (mm) Dimensions (mm)	REFERENCIA Reference / Référence	
30 x 20	0807020300204	500
40 x 20	0807020400204	200
40 x 30	0807020400304	200
50 x 30	0807020500304	150
50 x 40	0807020500404	100
60 x 30	0807020600304	100
60 x 40	0807020600404	100
80 x 40	0807020800404	75
100 x 40	0807021000404	50
100 x 50	0807021000504	50
120 x 40	0807021200404	50
100 x 60	0807021200604	50





PLETINAS Y TIRANTES

Plates and stays / Plats et tirants

●●●● Pletinas pasamanos *Handrail plates / Plats à mains courantes*

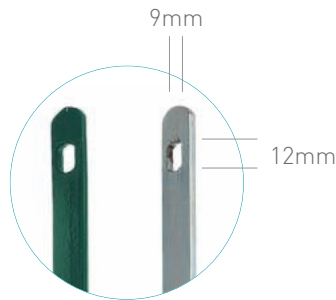

ALTURA MALLA (mm) Mesh height (mm) Hauteur grillage (mm)	GALVANIZADO Galvanized Galvanisé	VERDE RAL 6005 Green Ral 6005 Vert Ral 6005	
1000	0701204010000	0701204010002	10
1200	0701204012000	0701204012002	10
1500	0701204015000	0701204015002	10
2000	0701204020000	0701204020002	10

Pletina: 20 x 4 mm

●●●● Tirantes tornapuntas *Aligner stays / Supports tirants*

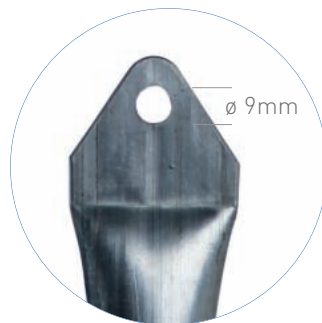

DIMENSIONES (mm) Dimensions (mm)	ALTURA MALLA (mm) Mesh height (mm) Hauteur grillage (mm)	GALVANIZADO Galvanized Galvanisé	VERDE RAL 6005 Green Ral 6005 Vert Ral 6005
Ø 35 x 1250	1000	0702351212500	0702351212502
Ø 35 x 1450	1200	0702351214500	0702351214502
Ø 35 x 1750	1500	0702351217500	0702351217502
Ø 35 x 2350	2000	0702351223500	0702351223502
Ø 48 x 1250	1000	0702481212500	0702481212502
Ø 48 x 1450	1200	0702481214500	0702481214502
Ø 48 x 1750	1500	0702481218000	0702481218002
Ø 48 x 2350	2000	0702481224000	0702481224002



TENSORES, TORNILLERÍA Y ANCLAJES

Tensors, screws and anchors / Tendeurs, visserie et ancrages

Tensor de chapa *Plate tensor / Tendeur de tôle*

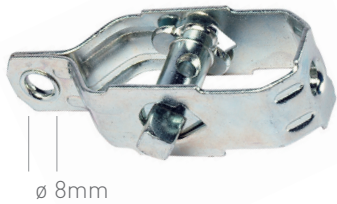

∅ 8mm

DIMENSIONES (mm) Dimensions (mm)	GALVANIZADO en caliente Galvanized in warm Galvanisé à chaud	
90 x 30 / 1,5	06019030151	200

DIMENSIONES (mm) Dimensions (mm)	GALVANIZADO Galvanized Galvanisé	VERDE RAL 6005 Green Ral 6005 Vert Ral 6005	BLANCO RAL 9010 White Ral 9010 Blanc Ral 9010	
90 x 30 / 1,5	06019030150	06019030152	06019030153	225

Carraca *Ratchet wrench / Clé à cliquet*



1312000000-

Casquillo cuadrado de 9 *Square bushing 9 / Douille carrée 9*



1313000000-

Tensores robustos *Strong tensors / Tendeurs renforcés*



DIMENSIONES (mm) Dimensions (mm)	REFERENCIA Reference / Référence
100 x 80	0605100800



DIMENSIONES (mm) Dimensions (mm)	REFERENCIA Reference / Référence
100 x 80	0607100800



DIMENSIONES (mm) Dimensions (mm)	REFERENCIA Reference / Référence
180 x 80	0604180800



DIMENSIONES (mm) Dimensions (mm)	REFERENCIA Reference / Référence
180 x 80	0606180800

Anclajes *Anchors / Ancrages*



DIMENSIONES (mm) Dimensions (mm)	TALADRO Drill Trou
6 x 60	8
8 x 80	10
10 x 100	12

Tornillo tensor con tuerca *Tensioning screw with nut / Vis de tension avec écrou*



DIMENSIONES (mm) Dimensions (mm)	REFERENCIA Reference / Référence	
22 x 37 M 10	06022237100	450

Tornillos autotaladrantes *Self drilling screws / Vis autoperceuses*



DIMENSIONES (mm) Dimensions (mm)	REFERENCIAS Reference / Référence
4,2 x 13	IA10142137504
4,8 x 32	IA10148327504

Tornillos y tuercas *Screws and nuts / Vis et écrous*

Tornillos *Screws / Vis*



DIMENSIONES (mm) Dimensions (mm)	REFERENCIAS Reference / Référence
6 x 60 DIN 933	IA10006600933
6 x 70 DIN 933	IA10006700933
7 x 25 DIN 933	IA10007250933
8 x 25 DIN 933	IA10008250933

Tuercas *Nuts / Écrous*

DIMENSIONES (mm) Dimensions (mm)	REFERENCIAS Reference / Référence
M-8 DIN 934	IB100080934
M-7 DIN 934	IB100070934
M-6 DIN 934	IB100060934

Unidades por embalaje
Pieces per pack / Unités par emballage



PLACAS Y UÑAS

Metal plates and toes / Plaques et griffes

Placas Metal plates / Plaques



95 x 22 x 3 0501209502230 300



120 x 22 x 3 0501212002230 200

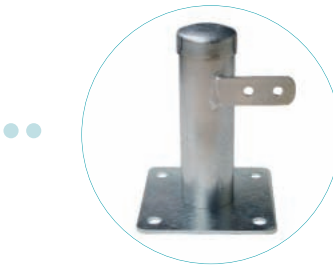

162 x 22 x 3 0501216202230 200

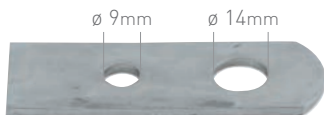

80 x 30 x 3 0501208003030 350

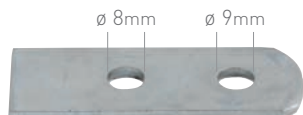

65 x 25 x 3 0501206502530 400



80 x 22 x 3 0501208002230 500

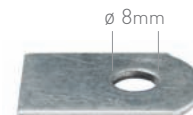

35 x 22 x 3 0501203502230 1000

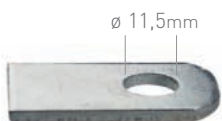

45 x 25 x 3 0501404502530 500

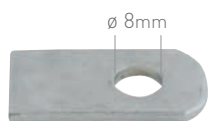

45 x 25 x 3 0501204502530 500



45 x 22 x 3 0501204502230 1000



50 x 30 x 3 0501105003030 500



70 x 30 x 3 0501207003030 400

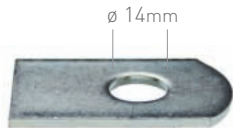

50 x 30 x 3 0501205003030 600

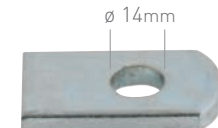

50 x 30 x 6 0501205003060 300

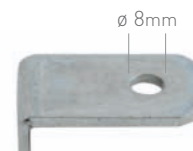

45 x 25 x 3 0501304502530 500

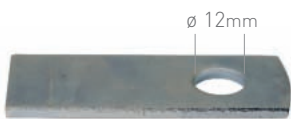

65 x 30 x 3 0501206503030 200

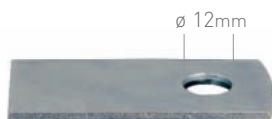

65 x 25 x 3 0501506502530 400

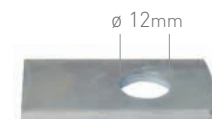

45 x 25 x 6 0501504502530 500

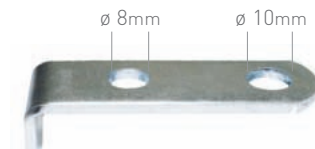

60 x 22 x 3 0501308002230 500



70 x 60 x 5 0501207006050 125



70 x 60 x 5 0501107006050 125

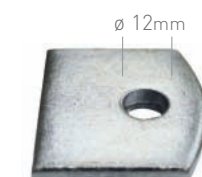

45 x 50 x 8 0501204505080 150

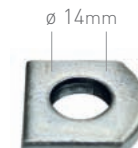

30 x 30 x 6 0501203003060 150



DIMENSIONES (mm) Dimensions (mm)	GALVANIZADO Galvanized Galvanisé	VERDE RAL 6005 Green Ral 6005 Vert Ral 6005	BLANCO RAL 9010 White Ral 9010 Blanc Ral 9010	
60 x 18 x 2,5	0403001000	0403001002	0403001003	100



DIMENSIONES (mm) Dimensions (mm)	GALVANIZADO Galvanized Galvanisé	VERDE RAL 6005 Green Ral 6005 Vert Ral 6005	BLANCO RAL 9010 White Ral 9010 Blanc Ral 9010	
60 x 18 x 2,5	0404001000	0404001002	0404001003	100

●●●● Placas base *Baseplates / Plaques base*

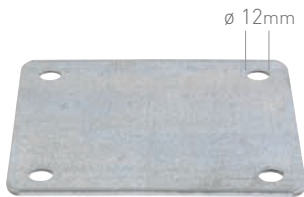

DIMENSIONES (mm) <i>Dimensions (mm)</i>	GALVANIZADO <i>Galvanized Galvanisé</i>	
120 x 100 x 4	0501212010040	60
120 x 120 x 4	0501212012040	60
140 x 120 x 5	0501214012050	40



DIMENSIONES (mm) <i>Dimensions (mm)</i>	GALVANIZADO <i>Galvanized Galvanisé</i>	
120 x 100 x 3	0501112010030	60
140 x 120 x 3	0501114012030	60



DIMENSIONES (mm) <i>Dimensions (mm)</i>	GALVANIZADO <i>Galvanized Galvanisé</i>	
140 x 60 x 5	0501214006050	30
140 x 40 x 4	0501214004040	40
140 x 30 x 3	0501214003030	50



DIMENSIONES (mm) <i>Dimensions (mm)</i>	GALVANIZADO <i>Galvanized Galvanisé</i>	
75 x 49 x 3	0501107504930	200



DIMENSIONES (mm) <i>Dimensions (mm)</i>	GALVANIZADO <i>Galvanized Galvanisé</i>	
220 x 120 x 4	0501322012040	10

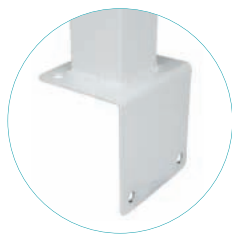

●●●● Pinza para valla móvil *Clamp for mobile fence / Pince pour clôture mobile*



REFERENCIA <i>Reference / Référence</i>	
0400000400	30



●●●● Uñas para soldar *Toes for welding / Griffes à souder*



DIMENSIONES (mm) <i>Dimensions (mm)</i>	GALVANIZADO <i>Galvanized Galvanisé</i>	
35 x 15 x 2	0502103501520	2000
28 x 10 x 2,5	0502102801020	3000
24 x 10 x 1,5	0502402401010	3000



●●●● Uña para atornillar o remachar *Toe for screwing or riveting Griffe à visser ou à riveter*



DIMENSIONES (mm) <i>Dimensions (mm)</i>	GALVANIZADO <i>Galvanized Galvanisé</i>	
35 x 15 x 2	0502203501520	2000

●●●● Grapa arpón *Spear staple / Agrafe-harpon*



DIMENSIONES (mm) <i>Dimensions (mm)</i>	GALVANIZADO <i>Galvanized Galvanisé</i>	
62 x 7	0505000000000	1000



●●●● Anilla para valla móvil *Ring for mobile fence Anneau pour clôture mobile*



REFERENCIA <i>Reference / Référence</i>	
0503209005900	600

Unidades por embalaje
Pieces per pack / Unités par emballage

accesorios para puertas correderas

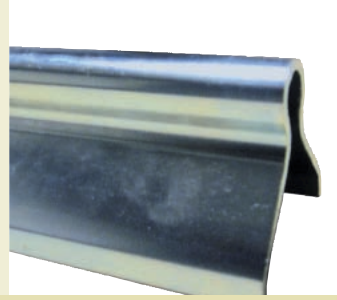

cierres y cerrojos



pernios y asas

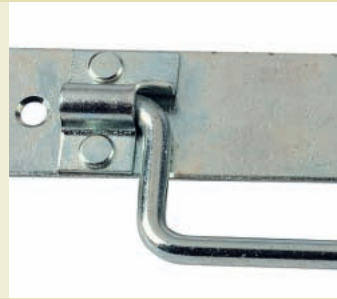

pasadores y piquetas

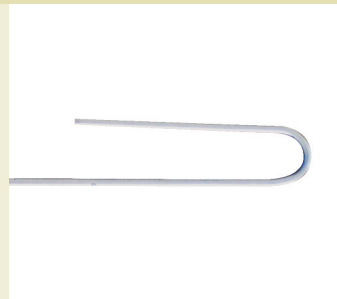

tendederos





ACCESORIOS PARA PUERTAS CORREDERAS

Sliding doors accessories

Accessoires pour portes coulissantes

CIERRES Y CERROJOS

Locks and bolts / Fermetures et verroux

PERNIOS DE ALA

Wing hinges / Paumelles aile

ASAS *Handles / Anses*

TIRADORES *Knobs / Poignées*

TENDEDEROS

Clotheslines / Étendoirs



ACCESORIOS PARA PUERTAS CORREDERAS

Sliding doors accessories / Accessoires pour portes coulissantes

●●●● Guía Omega 20 para encastrar

Omega 20 slide for attaching
Rail omega 20 pour enclencher

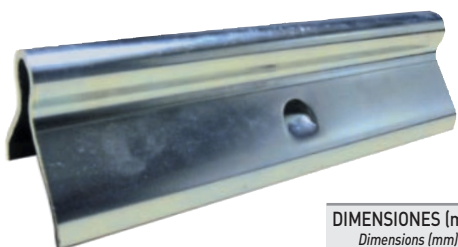

DIMENSIONES (mm) Dimensions (mm)	REFERENCIA Reference / Référence
3000	1803043000200

●●●● Guía Omega 20 para atornillar

Omega 20 slide for screwing
Rail omega 20 pour visser



DIMENSIONES (mm) Dimensions (mm)	REFERENCIA Reference / Référence
3000	1803053000200

●●●● Rueda Omega 20 con tornillo

Omega 20 caster with screw
Roue omega 20 avec vis



DIMENSIONES (mm) Dimensions (mm)	REFERENCIAS Reference / Référence
80	1801010080200
100	1801010100200

●●●● Rueda Omega 20 con soporte

Omega 20 caster with support
Roue omega 20 avec support



DIMENSIONES (mm) Dimensions (mm)	REFERENCIAS Reference / Référence
80	1801030080200
100	1801030100200

●●●● Rueda Omega 20 para soldar

Omega 20 caster for welding
Roue omega 20 pour souder



DIMENSIONES (mm) Dimensions (mm)	REFERENCIAS Reference / Référence
80	1801020080200
100	1801020100200

●●●● Rodillos de nylon

Nylon rollers / Rouleaux nylon



DIMENSIONES (mm) Dimensions (mm)	REFERENCIAS Reference / Référence
35 x 35	1802000035350
40 x 60	1802000040600



●●●● Encuentro cierre

Gathering lock
Rencontre fermeture



PERFIL Profile / Profil	REFERENCIAS Reference / Référence
60	180400000P600
80	180400000P800
100	180400000P1000

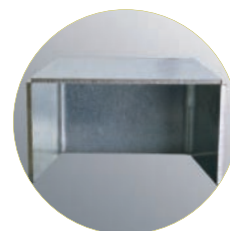

●●●● Soporte para rodillos de nylon

Support for nylon rollers / Support pour rouleaux nylon

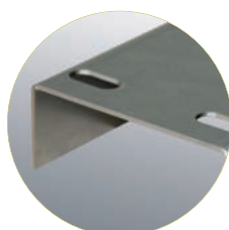

DIMENSIONES (mm) Dimensions (mm)	VALIDO PARA PERFILES Valid for profiles Valable pour profils	REFERENCIA Reference Référence
500	Desde 40 hasta 60mm	1805000005000
600	Desde 40 hasta 60mm	1805000006000
700	Desde 40 hasta 60mm	1805000007000
800	Desde 60 hasta 80mm	1805000008000
900	Desde 60 hasta 80mm	1805000009000
1100	Desde 80 hasta 100mm	1805000011000



CIERRES Y CERROJOS

Locks and bolts / Fermetures et verroux



●●●● Cancela *Door bolt / Verrou rond*



DIMENSIONES (mm) <i>Dimensions (mm)</i>	REFERENCIAS <i>Reference / Référence</i>	
200	0901200150	10
250	0901250180	10
330	0901330220	15
500	0901500250	10

●●●● Balancín *Clamping lever / Balancier*



REFERENCIA <i>Reference / Référence</i>	
0906000000	50



●●●● Cerrojo bajo puerta *Gate shoot bolt / Verrou à bec de cane*

Gate shoot bolt / Verrou à bec de cane



DIMENSIONES (mm) <i>Dimensions (mm)</i>	REFERENCIA <i>Reference / Référence</i>	
400	0902400140	10

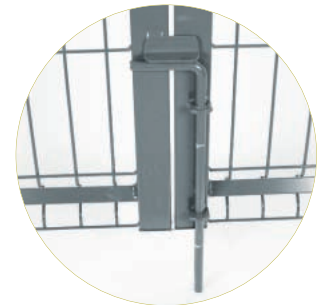

●●●● Candados latón *Brass padlocks / Cadenas laiton*

Brass padlocks / Cadenas laiton



DIMENSIONES (mm) <i>Dimensions (mm)</i>	ARCO NORMAL <i>Normal arc Arc normal</i>	ARCO LARGO <i>Long arc Arc long</i>
30	19010130	19010230
40	19010140	19010240
50	19010150	19010250
60	19010160	-

●●●● Candados Titalium *Titalium padlocks / Cadenas titalium*

Titalium padlocks / Cadenas titalium



DIMENSIONES (mm) <i>Dimensions (mm)</i>	ARCO NORMAL <i>Normal arc Arc normal</i>	ARCO LARGO <i>Long arc Arc long</i>
30	19020130	19020230
40	19020140	19020240
50	19020150	19020250
60	19020160	-



PERNIOS Y ASAS

Hinges and handles / Paumelles et anses

●●●● Pernios Hinges / Paumelles



Ala larga Long wing / Aile longue

DIMENSIONES (mm) Dimensions (mm)	GALVANIZADO Galvanized Galvanisé	PULIDO Polished Poli	
25 x 150 x 5	12012515050	1201251505A	18c. /36 paq.
25 x 120 x 5	12012512050	1201251205A	18c. /36 paq.
20 x 120 x 5	12012012050	1201201205A	24c. /48 paq.
18 x 110 x 4	12011811040	1201181104A	30c. /60 paq.
16 x 100 x 3	12011610030	1201161003A	40c. /160 paq.
14 x 80 x 3	12011408030	1201140803A	50c. /200 paq.
12 x 80 x 2	12011208020	1201120802A	60c. /240 paq.

Ala corta Short wing / Aile courte

DIMENSIONES (mm) Dimensions (mm)	GALVANIZADO Galvanized Galvanisé	PULIDO Polished Poli	
14 x 80 x 3	12021408030	1202140803A	50c. /200 paq.

●●●● Para soldar For welding / Pour souder



DIMENSIONES (mm) Dimensions (mm)	REFERENCIAS Reference / Référence	
120 x 60	100312060120	10
160 x 60	100316060120	10
180 x 60	100318060120	10

●●●● Plegable Foldable / Pliable



DIMENSIONES (mm) Dimensions (mm)	REFERENCIAS Reference / Référence	
120	100212030000	10
140	100214030000	10
160	100216030000	10
180	100218030000	10

●●●● Manillón recto de acero Steel pull handle / Poignée acier droite



DIMENSIONES (mm) Dimensions (mm)	NEGRO Black Noir	
200	100120070004	6

●●●● Cartela decorativa "Flor de Lis" Decorative cartouche "Fleur-de-lys" Cartouche décorative « Fleur de lys »



REFERENCIA Reference / Référence	
0504113007630	250

Unidades por embalaje
Pieces per pack / Unités par emballage



PASADORES Y PIQUETAS CAMPING

Pins and tent pegs / Goupilles et piquets

●●●● Pasador "R"

Beta pins / Goupille beta



DIMENSIONES (mm) <i>Dimensions (mm)</i>	GALVANIZADO <i>Galvanized Galvanisé</i>	
2	11030000	100
2,5	11030100	100
3	11030200	100
3,5	11030300	100
4	11030400	100
4,5	11030500	100
5	11030600	50
6	11030700	50
7	11030800	50
8	11030900	25
10	11031000	25

●●●● Pasador media caña

Cotter pins / Goupille fendue



DIMENSIONES (mm) <i>Dimensions (mm)</i>	GALVANIZADO <i>Galvanized Galvanisé</i>	
4,5 x 60	11020000	200
4,5 x 65	11020200	200
4,5 x 70	11020300	200
4,5 x 75	11020400	200

●●●● Pasador Anilla

Ring pin / Goupille clip



DIMENSIONES (mm) <i>Dimensions (mm)</i>	GALVANIZADO <i>Galvanized Galvanisé</i>	
4,5	11010000	100
6	11010100	100
7	11010200	100
8	11010300	50
9	11010400	50
10	11010400	50
11	11010600	50

●●●● Piquetas camping

*Tent pegs
Piquets de tente*



DIMENSIONES (mm) <i>Dimensions (mm)</i>	GALVANIZADO <i>Galvanized Galvanisé</i>	
7 x 175	11000000	50
7 x 275	11000100	50

●●●● Gancho de sujeción para las mangueras de riego por goteo

*Fastening hook for drip irrigation hoses
Crochet de fixation pour tuyaux d'irrigation goutte à goutte*



GALVANIZADO <i>Galvanized Galvanisé</i>	
11040000	500

Unidades por embalaje
Pieces per pack / Unités par emballage



●●●● Extensibles *Extendable / Extensible*



DIMENSIONES (mm) <i>Dimensions (mm)</i>	BLANCO RAL 9010 <i>White Ral 9010 Blanc Ral 9010</i>	GALVANIZADO <i>Galvanized Galvanisé</i>	ALUMINIO <i>Aluminium Aluminium</i>
70	1442070000003	1442070000000	1442070000008
80	1442080000003	1442080000000	1442080000008
90	1442090000003	1442090000000	1442090000008
100	1442100000003	1442100000000	1442100000008
110	1442110000003	1442110000000	1442110000008
120	1442120000003	1442120000000	1442120000008
130	1442130000003	1442130000000	1442130000008
140	1442140000003	1442140000000	1442140000008
150	1442150000003	1442150000000	1442150000008
160	1442160000003	1442160000000	1442160000008
170	1442170000003	1442170000000	1442170000008
180	1442180000003	1442180000000	1442180000008
190	1442190000003	1442190000000	1442190000008
200	1442200000003	1442200000000	1442200000008



●●●● Para atornillar *To screw / Pour visser*



DIMENSIONES (mm) <i>Dimensions (mm)</i>	BLANCO RAL 9010 <i>White Ral 9010 Blanc Ral 9010</i>
540 x 200	1412054002003

●●●● Brazo balcón *Arm for balcony / Bras pour balcon*



DIMENSIONES (mm) <i>Dimensions (mm)</i>	BLANCO RAL 9010 <i>White Ral 9010 Blanc Ral 9010</i>
540 x 250	1422054002503

●●●● Tendedero jardín *Clothesline for garden / Étendoir jardin*



Desmontable
Detachable / Démontable

DIMENSIONES (mm) <i>Dimensions (mm)</i>	BLANCO RAL 9010 <i>White Ral 9010 Blanc Ral 9010</i>	VERDE RAL 6005 <i>Green Ral 6005 ert Ral 6005</i>
2000 x 640	1431230006403	1431230006402
1750 x 640	1432180006403	1432180006402



●●●● Tendedero en T para muro *Clothesline for wall / Séchoir en T mural*



DIMENSIONES (mm) <i>Dimensions (mm)</i>	REFERENCIA <i>Reference / Référence</i>
640 x 1200	1452120006403

info@industriasimeca.com

www.industriasimeca.com

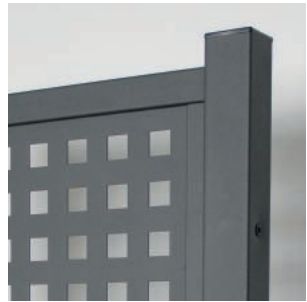

Desde 1987

INDUSTRIAS METÁLICAS CASINENSES, S.L.

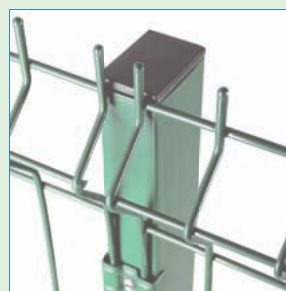

Pol. Ind. El Secano - C/ Chulilla, 5 - 46174 DOMEÑO - Valencia - España
Tel. 96 272 80 84 - Fax 96 272 80 87 - e-mail: info@industriasimeca.com

www.industriasimeca.com